



CH^{DE}

PROGRAMM

Ab 2023



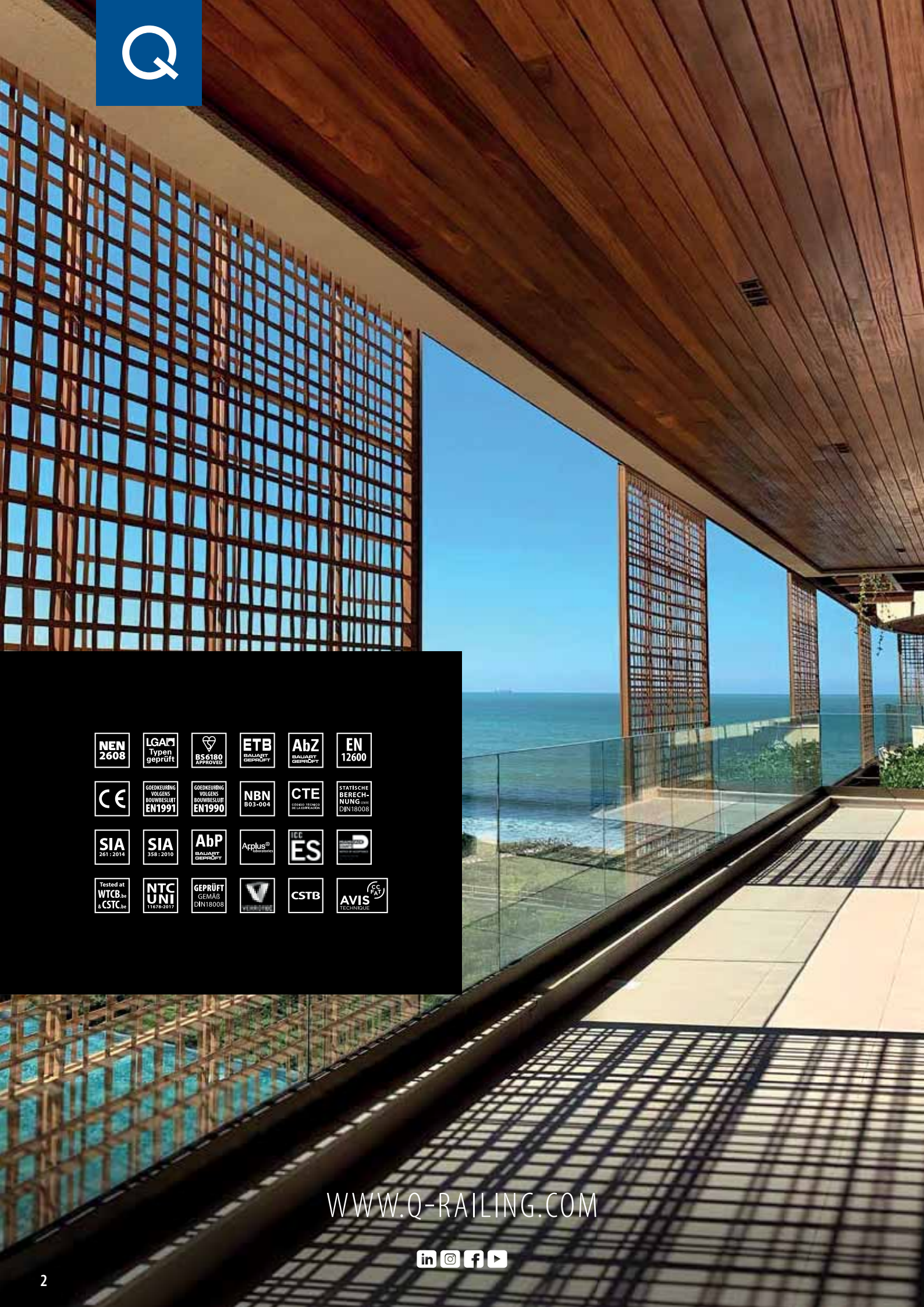

NEN 2608	LGAM Typen geprüft	BS 6180 APPROVED	ETB BALAJART GEPRÜFT	AbZ BALAJART GEPRÜFT	EN 12600
CE	GOEDKEURING VOLGENS BOUWBESLUIT EN1991	GOEDKEURING VOLGENS BOUWBESLUIT EN1990	NBN B03-004	CTE CONFORME AVEC LE REGLEMENT DIN18008	STATISCHE BERECHNUNG DIN18008
SIA 261 : 2014	SIA 358 : 2010	AbP BALAJART GEPRÜFT	AppPlus laboratoire	ICC ES	D
Tested at WTCB & CSTC	NTC UNI 11678-2017	GEPRÜFT GEMÄß DIN18008	V	CSTB	AVIS TECHNIQUE CE FAI

WWW.Q-RAILING.COM



WILLKOMMEN BEI DER PREMIUM MARKE FÜR GELÄNDERSYSTEME

Was bedeutet Premium für uns? Es bedeutet, dass wir nicht ruhen, bis wir die Perfektion erreicht haben, die Sie erwarten.

PREMIUM IN JEDER HINSICHT

Nur das Beste

- Gleichbleibende Qualität
- Hochwertige Materialien
- Makellose Oberflächen
- Extrem präzise Masse und minimale Toleranzen

Erstaunlich schnell

- Alles sofort ab Lager lieferbar
- Schnelle Lieferung
- Fundierte technische Beratung

Unbegrenzte Möglichkeiten

- Unzählige Produkte
- Zahlreiche Designvarianten
- Hier finden Sie alles, um ein komplettes Geländer oder Handläufe zu kreieren
- Kombinieren Sie die Komponenten nach Belieben und schaffen Sie einen individuellen Look

100% sicher

- Ausgiebige Tests im unternehmenseigenen Prüflabor
- Umfangreiche Prüfungen durch unabhängige, zertifizierte Prüfstellen und führende Behörden
- Testverfahren und behördliche Genehmigungen entsprechend der internationalen Bauvorschriften und Normen

Ästhetik und Raffinesse

- Regelmässige Produktinnovationen und Produktoptimierungen
- Vortreffliches Design
- Ausgeklügelte Details, die eine schnelle und einfache Montage ermöglichen

Onlineangebot : www.q-railing.com

- Montagevideos, BIM-Objekte, CAD-Zeichnungen und weitere technische Dokumente und Ausschreibungstexte
- Q-PAC (Professional Anchor Calculation) Software, mit der Sie genau den richtigen Q-railing Anker finden, den Sie benötigen
- Kataloge, Broschüren, Referenzprojekte und vieles mehr





1

GANZGLAS- GELÄNDERSYSTEME

SYSTEMÜBERSICHT

6-7

FINDEN SIE IHR PRODUKT

8-9

PRODUKTE FÜR GELÄNDERBASIS

GLAS UND GLASVERBINDER

PRODUKTE FÜR HANDLÄUFE

26 - 185



2

SYSTEME FÜR FRANZÖSISCHE BALKONE

SYSTEMÜBERSICHT

10-11

FINDEN SIE IHR PRODUKT

10-11

EASY GLASS® VIEW

EASY GLASS® MOD 6507-6508

MIT GLASKLEMMEN

MIT GLASADAPTERN

FENSTERABSTURZSTANGEN

186 - 231



3

Q-LIGHTS SYSTEME

SYSTEMÜBERSICHT

12-13

FINDEN SIE IHR PRODUKT

12-13

SPOTLIGHT FÜR HANDLÄUFE

LINEAR LIGHT FÜR GLASLEISTENROHRE

LINEAR LIGHT FÜR HANDLÄUFE

232 - 265



4

PFOSTENGELÄNDER-SYSTEME

SYSTEMÜBERSICHT	14 - 15
FINDEN SIE IHR PRODUKT	16 - 17
PRODUKTE FÜR GELÄNDERPFOSTEN	
PRODUKTE FÜR HANDLÄUFE	
FÜLLUNGEN	

266 - 419



5

GLAS-BEFESTIGUNGEN

FINDEN SIE IHRE GLASBEFESTIGUNG	423 - 430
GLASKLEMMEN	430 - 442
GLASHALTER	444 - 445
GLASVERBINDER	446 - 448
SCHARNIERE UND TÜRRIEGEL	448 - 449
GLASADAPTER	451 - 453

420 - 453



6

ZUBEHÖR

ÜBERSICHT Q-SCREWS	456
FINDEN SIE DEN RICHTIGEN ANKER	457 - 463
ANKER	464 - 467
SCHRAUBEN UND BEFESTIGUNGSMATERIAL	468 - 474
ERSATZMATERIAL FÜR GLASKLEMMEN UND -ADAPTER	475
BOHREN UND GEWINDESCHNEIDEN	476 - 477
MONTAGEZUBEHÖR	478 - 481
PFLEGE UND REINIGUNG	482
WERKZEUG	483 - 485
SYMBOLVERZEICHNIS	487

454 - 487



1

GANZGLAS- GELÄNDERSYSTEME

26 - 185



EASY GLASS® SMART

≡ 12 - 21,52 mm ▲ ● H | IHI



EASY GLASS® SMART+

≡ 16,76 - 21,52 mm ▲ H | IHI

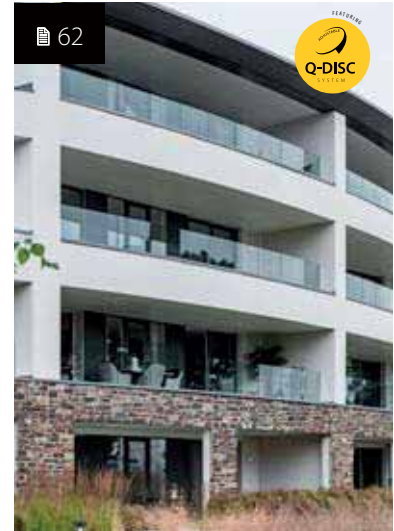

EASY GLASS® PRIME

≡ 16,76 - 25,52 mm ▲ H | IHI



EASY GLASS® MAX

≡ 19 - 31,52 mm ● IHI | IIII



EASY GLASS® UP

≡ 12 - 17,52 mm ● H | IHI



EASY GLASS® HYBRID

≡ 8 - 13,52 mm ● H | IHI

Eine optimale Nutzung von Licht und Raum ist entscheidend – egal ob es sich bei Ihrem Projekt um ein Einfamilienhaus oder ein Stadion für Tausende von Besuchern handelt.

Die Ganzglas-Geländersysteme von Q-railing helfen Ihnen dabei, maximale Transparenz und somit eine helle, offene Umgebung mit uneingeschränkter Sicht zu schaffen.



EASY GLASS® **STRONG**

≡ 21,52 - 33,04 mm ▲ | H | H | H



EASY GLASS® **SLIM**

≡ 12 - 21,52 mm ● H



EASY GLASS® **PRO**

≡ 12 - 21,52 mm ▲ ● H | H | H



EASY GLASS® **BODENGLASKLEMMEN**

≡ 12 - 21,52 mm ● H | H | H



EASY GLASS® **AIR**

≡ 15 - 21,52 mm ● H | H | H



EASY GLASS® **GLASADAPTER**

≡ 8 - 25,52 mm ▲ ● H | H | H

≡ = Glasstärke ▲ = Justierbar ● = Nicht justierbar

H = Leichte Beanspruchung | H | H = Mittlere Beanspruchung | H | H | H = Hohe Beanspruchung | H | H | H | H = Besonders hohe Beanspruchung



1

GANZGLAS- GELÄNDERSYSTEME

26 - 185

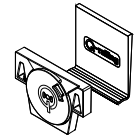
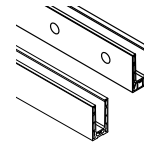

A

GELÄNDERBASIS

BODENPROFILE

GLASFIXIERUNG

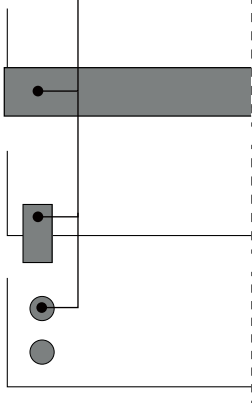

EASY GLASS® SMART	33, 36, 38, 44	31-32
EASY GLASS® SMART+	54, 55	53
EASY GLASS® PRIME	66, 68, 70, 76	65
EASY GLASS® STRONG	86, 88	85
EASY GLASS® SLIM	97, 99, 100	96
EASY GLASS® PRO	108, 110, 112, 114	106-107
EASY GLASS® MAX	119, 121, 122, 124	118
EASY GLASS® UP	130, 131	128
EASY GLASS® HYBRID	136	136
EASY GLASS® BODENGLASKLEMMEN		
EASY GLASS® AIR		
EASY GLASS® GLASADAPTER		

B

GLAS

Q-GLASS

GLASVERBINDER

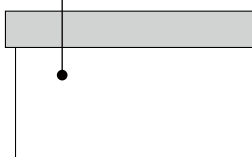

MASSGEFERTIGTES GLAS	160	162-164
GLAS AB LAGER	161	

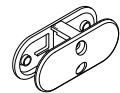

C

HANDLÄUFE

KANTENSCHUTZ

U-PROFILE

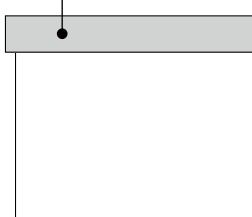

EASY GLASS® SMART	166	167
EASY GLASS® SMART+		
EASY GLASS® PRIME		
EASY GLASS® STRONG		
EASY GLASS® SLIM		
EASY GLASS® PRO		
EASY GLASS® MAX		
EASY GLASS® UP	166	167
EASY GLASS® HYBRID		
EASY GLASS® BODENGLASKLEMMEN		
EASY GLASS® AIR	166	167
EASY GLASS® GLASADAPTER		

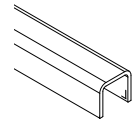
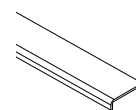

SO FINDEN SIE GANZ EINFACH IHRE PRODUKTE

Unsere Geländersysteme bestehen in der Regel aus drei Segmenten: Geländerbasis **A**, Glas **B** und Handlauf **C**. Diese sind in verschiedene Produktgruppen unterteilt. Ermitteln Sie das Segment und die Produktgruppe - und finden Sie so auf Anhieb die gewünschten Artikel.

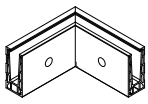
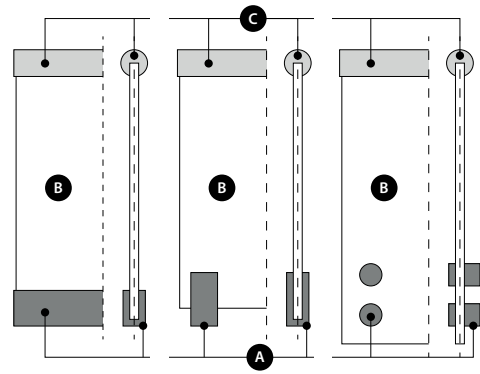

ECKEN

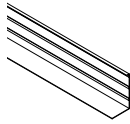

BLENDLEISTEN

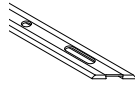

DRAINAGELEISTEN

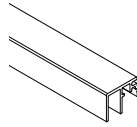

BAUANSCHLUSS-LEISTEN



BODENGLASKLEMMEN



GLASADAPTER



BEFESTIGUNGSMATERIAL

34, 37, 38, 45	42, 47	35, 41	37, 48-49			456-463
54-55	57	56	59-60			
66, 69, 70, 77	74, 79	67, 73	80-81			
86, 88	91	87, 90	92-93			
97, 99, 100	102	98				
109, 110, 112, 115	113, 115	109, 112				
123, 121, 122, 124	123, 125					
130, 131	132	133				
				142-145		
				148		
					152-159	

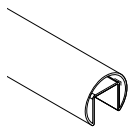

GLASLEISTENROHRE

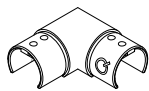

VERBINDER

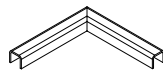

ECKEN



WANDFLANSCH



ENDSTÜCKE

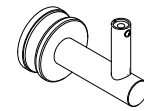

HANDLAUFSTÜTZEN

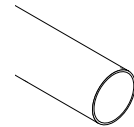

ROHRE

169-170, 174, 176, 178, 180, 182, 184	169, 171-173, 175, 177, 179, 181, 183, 185	166, 168, 174, 178	173, 177, 181, 182, 184	168, 169, 173, 174, 177, 178, 181, 182, 185	286, 297, 340-341, 365	285, 300, 351, 367
137-138			137-138			
169-170, 174, 176, 178, 180, 182, 184	169, 171-173, 175, 177, 179, 181, 183, 185 148	166, 168, 174, 178	173, 177, 181, 182, 184 149	168, 169, 173, 174, 177, 178, 181, 182, 185 149	286, 297, 340-341, 365	285, 300, 351, 367 149
	169, 171-173, 175, 177, 179, 181, 183, 185	166, 168, 174, 178	173, 177, 181, 182, 184	168, 169, 173, 174, 177, 178, 181, 182, 185	286, 297, 340-341, 365	285, 300, 351, 367



2

SYSTEME FÜR FRANZÖSISCHE BALKONE

186 - 231



EASY GLASS® VIEW

12 - 21,52 mm



EASY GLASS® MOD 6507 / 6508

8 - 21,52 mm

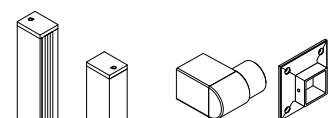

PROFILE ZUR WANDMONTAGE

WANDFLANSCH

FRANZÖSISCHE BALKONE

EASY GLASS® VIEW	192-193, 195	
EASY GLASS® MOD 6507 / 6508		200-208
MIT GLASKLEMMEN		
MIT GLASADAPTERN		
FENSTERABSTURZSTANGEN		220-221, 223-230

Ein französischer Balkon bietet nicht nur ein Plus an Sicherheit, sondern verleiht der Fassade auch einen ausdrucksstarken Look. Damit Sie die passende Geländer-Lösung für Ihr Projekt finden, gibt es im Q-railing Sortiment eine grosse Auswahl an Komponenten für französische Balkone.



210
MIT GLASKLEMMEN
 = 9,52 - 21,52 mm ● H | II



212
MIT GLASADAPTERN
 = 8 - 31,52 mm ▲ H | II



218
FENSTERABSTURZSTANGEN
 ● H

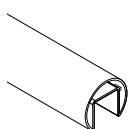

GLASLEISTENROHRE

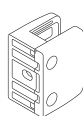

GLASKLEMMEN

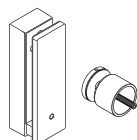

GLASADAPTER

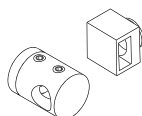

STABHALTER

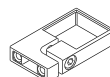

ROHRHALTER

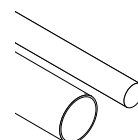

STAB UND ROHR



ENDSTÜCKE

						197
200-207, 209						
	211					
		213-217				
			219, 222	221	219-221, 223-231	219, 221-222, 225

= = Glasstärke ▲ = Justierbar ● = Nicht justierbar
 H = Leichte Beanspruchung II = Mittlere Beanspruchung



3

Q-LIGHTS SYSTEME 232 - 265



Q-LIGHTS **SPOTLIGHT**

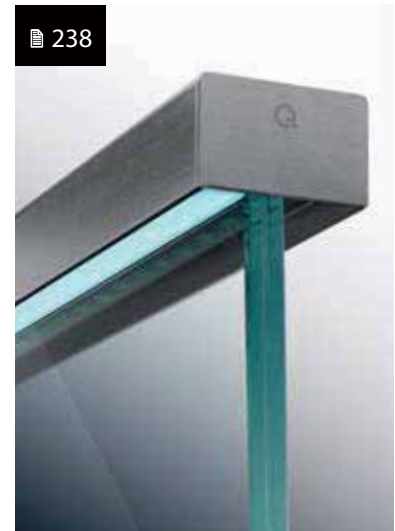

Q-LIGHTS **LINEAR LIGHT**

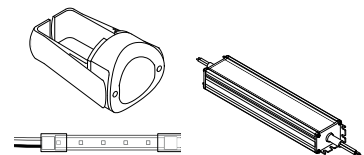

LED-BÄNDER /
LED-SPOTLIGHTS

TRANSFORMATOREN

PRODUKTGRUPPEN

Q-LIGHTS SPOTLIGHT	236	237
Q-LIGHTS LINEAR LIGHT	238, 245	239, 246

Schaffen Sie mit einer stilvollen Geländerbeleuchtung eine ganz besondere Atmosphäre und ein Plus an Sicherheit.

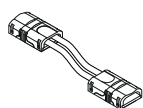

VERBINDER

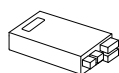

STEUERUNGSGERÄTE

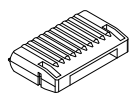

STROMVERSORGUNG

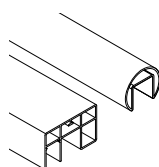

GLASLEISTENROHRE
/ HANDLÄUFE

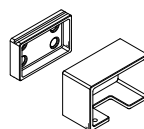

WANDFLANSCH

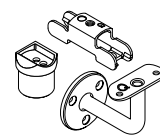

HANDLAUFSTÜTZEN
/ -ADAPTER

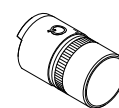

VERBINDER

			351	265	260-262	352-355
240-242, 247-251	252	252-253	254, 257, 259	254, 265	256, 258, 260-262	255, 263-264



4

PFOSTENGELÄNDER-SYSTEME

266 - 419



EASY ALU



SQUARE LINE® 40x10

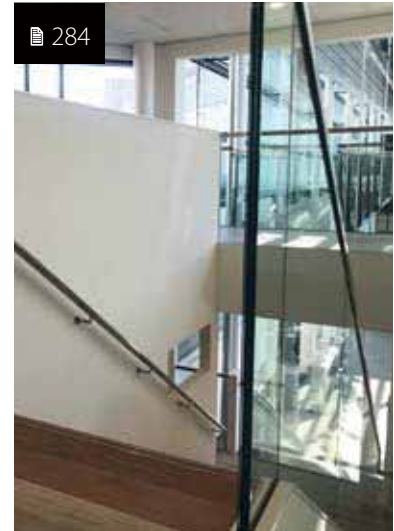

SQUARE LINE® 40x20



BARRIER LINE



Q-LINE HOCHGLANZPOLIERT



SCHWEISSTEILE

Verwenden Sie ein Pfostengeländersystem von Q-railing, um Ihrer Treppe, Ihrem Balkon oder Galerie einen besonderen Look zu verleihen. In unserem umfangreichen Sortiment finden Sie Lösungen für nahezu jede Montagesituation und Designanforderung.



288

SQUARE LINE® 40x40

H



302

SQUARE LINE® 60x30

H | H-H



308

Q-LINE

H | H-H



382

BENDYWOOD



384

NATURAIL



386

FÜLLUNGEN



4

PFOSTENGELÄNDER-SYSTEME

266 - 419

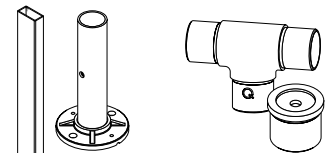

A

GELÄNDERPFOSTEN

GELÄNDERPFOSTEN

VERBINDER / ADAPTER

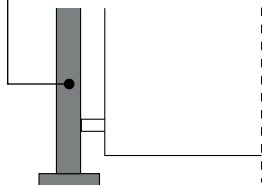

EASY ALU	270, 273	
SQUARE LINE® 40x40	290-291	296, 301
SQUARE LINE® 60x30	304	305
Q-LINE	310-314, 316, 320-322	332-333, 354, 356
BARRIER LINE	361	
Q-LINE HOCHGLANZPOLIERT	363	365, 368

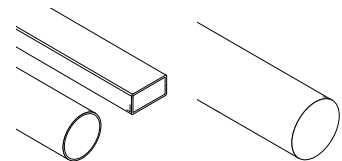

B

HANDLÄUFE / WANDHANDLÄUFE

ROHRE

HOLZHANDLÄUFE

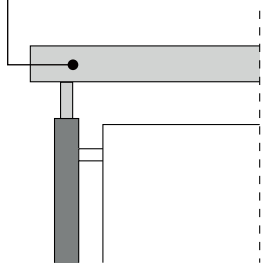

EASY ALU	275-276	
SQUARE LINE® 40x10	282	
SQUARE LINE® 40x20	285	
SQUARE LINE® 40x40	300	
SQUARE LINE® 60x30	305, 307	
Q-LINE	351	383-384
Q-LINE HOCHGLANZPOLIERT	367	
BENDYWOOD		383
NATURAIL		384

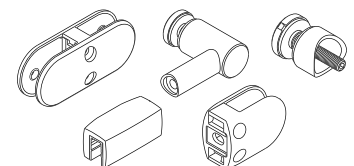

C

FÜLLUNGEN

GLASBEFESTIGUNGEN

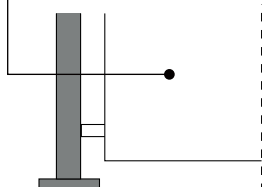

EASY ALU	
SQUARE LINE® 40x40	
SQUARE LINE® 60x30	431-453
Q-LINE	
Q-LINE HOCHGLANZPOLIERT	432-434, 438, 452-453

SO FINDEN SIE GANZ EINFACH IHRE PRODUKTE

Unsere Geländersysteme bestehen in der Regel aus drei Segmenten: Geländerpfosten **A**, Handlauf **B** und Füllung **C**. Diese sind in verschiedene Produktgruppen unterteilt. Ermitteln Sie das Segment und die Produktgruppe - und finden Sie so auf Anhieb die gewünschten Artikel.

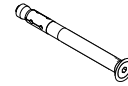
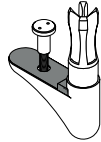
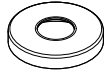
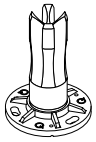
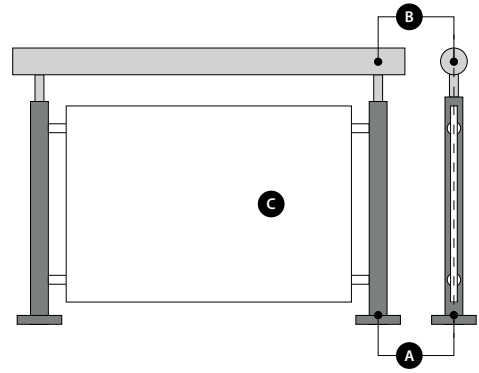

BODENFLANSCH

ABDECKKAPPEN

TREPPENFLANSCH

GELÄNDERPFOSTEN-
HALTERUNGEN

SCHWEISSTEILE

BEFESTIGUNGS-
MATERIAL

271	274		274		457-473
290, 292	290-292		293	374	
304	304-305		305	374	
310-312, 316	310-312, 315	322-323	317-319	373-374	
312	361				
			363		

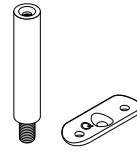
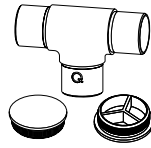
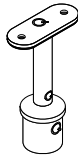
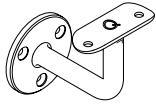

HANDLAUFSTÜTZEN

ROHRSTÜTZEN

VERBINDER /
ENDSTÜCKE

WANDFLANSCH

HANDLAUF-
STÜTZENTEILE

SCHWEISSTEILE

		277-279	278		375-379
282		283			
286-287		285	285		
297-299	294-295	300-301	301	296	
	306	305, 307	307	305	
338-349	324-326, 328-332, 349	352-358	359	329, 334-337	
365-366	364	367-368	368		
345-346, 349	324-326, 338	385			

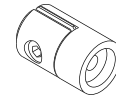
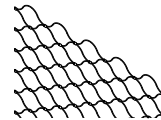
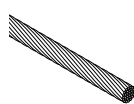
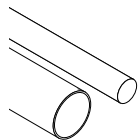
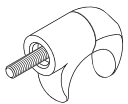

GLASRAHMENROHR

GLAS

STAB UND ROHR

DRAHTSEIL

NETZ

BLECHADAPTER

388-390	386-387	392-394, 396-397, 399, 401-403	405-411	413-414	417-419
		392-393, 395-397, 401-403			370-371
		369			

Easy Glass® Smart+

Suchen Sie nach einem schmalen Bodenprofil mit dem Sie auch Glasstärken bis zu 21,52 mm nicht nur problemlos installieren, sondern auch präzise ausrichten können? Dann gibt es mit Easy Glass® Smart+ jetzt die Lösung! Die neuen Bodenprofile beinhalten das justierbare Q-disc® System zur einfachen Glasmontage und -ausrichtung.

☰ 50

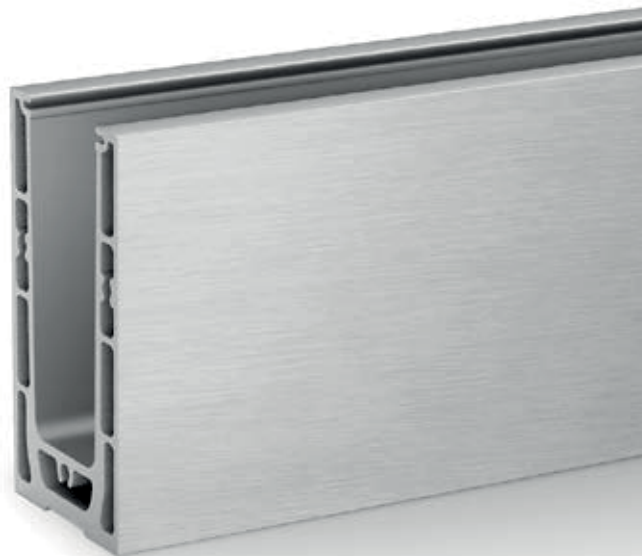

NEU 2023



Easy Glass® Strong

Ein extra starkes Bodenprofil plus Glasjustierung dank des innovativen Q-disc® Systems – das zeichnet das neue Glasgeländersystem Easy Glass® Strong aus. Die Kombination aus Kraft und Komfort macht es zu einer perfekten Lösung für Stadien, Flughäfen, Einkaufszentren und anderen öffentlichen Räumen.

☰ 82

Optionen für **französische Balkone**

Entdecken Sie die Ergänzungen zum beliebten Easy Glass® View System. Mithilfe der neuen vorgebohrten Wand- und Mittelprofile können Sie französische Balkone noch schneller montieren. Neben den bekannten Systemen View und MOD 6507-6508 gibt es aber noch weitere Optionen: Schaffen Sie einen sicheren, dennoch eleganten Absturzschutz mit Glasklemmen, Glasadaptern, Absturzstangen oder Easy Alu Geländern.

☰ 188



BLACK LINE



Das Black Line Sortiment bietet Ihnen eine breite Auswahl an schwarz pulverbeschichteten Komponenten für Pfosten- und Glasgeländer.



Handlaufstützen

Entdecken Sie die neuen Handlaufstützen und weitere Einzelkomponenten in unseren Q-line und Square Line® Serien.

Linear Light LED-Bänder und -Verbinder

Auch das Q-lights Linear Light Sortiment wurde erweitert – die neuen LED-Bänder, Verbinder und Transformatoren machen die Montage noch einfacher und vielseitiger. Da die neuen LED-Bänder mehr LED-Punkte pro Meter besitzen, schaffen Sie damit noch stimmungsvollere und sicherere Innenräume und Aussenflächen. Fügen Sie Q-lights Linear Light oder Spotlight ganz einfach zu Ihrem gewünschten Q-railing Geländer hinzu.

📄 238



Farbige LED-Bänder

Sie brauchen einen Farbtupfer? Dann versehen Sie Ihre Glas- oder Pfostengeländer mit farbigen statt weissen LED-Bändern. Diese sind auf Anfrage bei uns erhältlich.

Digitaler Katalog

Sie möchten eine digitale Version des Kataloges? Sie können den Katalog entweder direkt online durchblättern oder als PDF herunterladen und speichern: www.q-railing.com.

Benötigen Sie Unterstützung?

Haben Sie Fragen, benötigen Sie eine Beratung oder möchten Sie ein Angebot erhalten? Wir helfen Ihnen gerne weiter. Senden Sie uns eine E-Mail oder rufen Sie uns an – wir sind für Sie da!

QR-Codes für weitere Informationen

Scannen Sie die QR-Codes auf den Einführungsseiten der Systeme und gelangen Sie direkt zur jeweiligen Online-Systemseite mit weiteren Informationen: lassen Sie sich von Projektfotos inspirieren, sehen Sie sich Montagevideos und Installationshinweise an, laden Sie Testberichte oder CAD-Objekte herunter.

SCAN ME!



UNSERE MATERIALIEN, FARBEN UND OBERFLÄCHEN



304

316

Edelstahl

Mit seiner Robustheit und der schönen Oberfläche ist Edelstahl eines der beliebtesten Materialien für Geländersysteme. Der Unterschied zwischen den verschiedenen Edelstahlsorten liegt in ihrer chemischen Zusammensetzung. Stahl korrodiert naturgemäss, aber verschiedene Elemente können ihm hinzugefügt werden, um ihn korrosionsbeständiger zu machen. Der Industriestandard für den Innenbereich ist Edelstahl V2A (304). Edelstahl V4A (316) enthält zusätzlich 2% Molybdän, was dazu führt, dass das Material widerstandsfähiger gegen Rissbildung, Lochfrass und Spannungsrisse ist. Daher empfehlen wir üblicherweise Edelstahl V4A (316) für den Einsatz im Aussenbereich.



Kunststoff

Das von uns verwendete thermoplastische Material verfügt über eine hervorragende chemische Beständigkeit und Belastbarkeit. Unsere Kunststoff-Abdeckkappen und -Blendstopfen sind in den passenden Farben zu den dazugehörigen Edelstahl-, Aluminium- und Zinkdruckguss-Produkten erhältlich. Das Material gewährt eine ausgewogene Beständigkeit gegen Stösse, Hitze, chemische Einflüsse und Abrieb. Ausserdem bietet es Dimensionsstabilität, Zugfestigkeit, Oberflächenhärte, Steifigkeit und gute elektrische Eigenschaften.

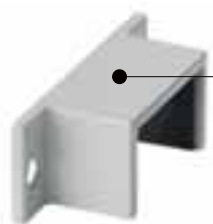

Aluminium

Aluminium ist leicht und gleichzeitig sehr robust und widerstandsfähig. Es hat eine natürlich auftretende Oxidschicht, die das Metall vor Korrosion schützt. Diese Schicht kann weiter verstärkt werden, um einen noch höheren Schutz zu bieten. Die meisten Aluminium-Produkte in diesem Katalog haben daher einen Anodisierungsprozess durchlaufen (25µ). Ist dies nicht der Fall, sprechen wir von Aluminium, roh.

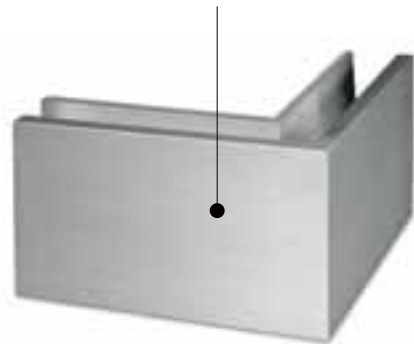

Zinkdruckguss

Zinkdruckgusserzeugnisse sind robust und preiswert, und daher eine kostengünstige Alternative zu anderen Metallen. Um dem Material eine attraktive Oberfläche zu verleihen, können Sie es mit einer Lackierung oder einer Beschichtung versehen. Viele der Zinkdruckgussprodukte von Q-railing sind bereits PVD- oder pulverbeschichtet und einbaufähig.













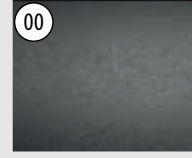
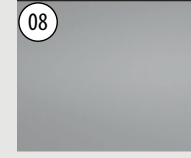

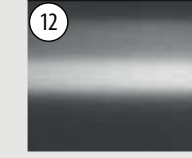







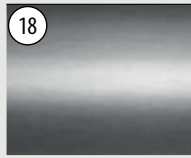

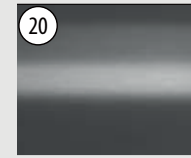
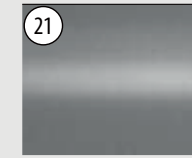
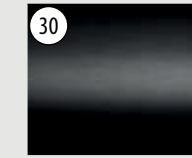





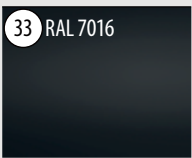

Stahl

Stahl gibt es in verschiedenen Legierungen, die jeweils für unterschiedliche Zwecke geeignet sind. Seine Stärke und Festigkeit hängen von der Kombination aus Eisen, Kohlenstoff und weiteren Zugaben ab. Stahl wertet Ihre Projekte auf, vor allem wenn die Komponenten passend zum gewünschten Farbschema pulverbeschichtet werden.

Unsere verfügbaren Farben und Oberflächenausführungen sind unten dargestellt. Bei den meisten Artikelnummern verweisen die letzten beiden Ziffern auf die entsprechende Farbe und/oder Oberfläche.

158238-36
 133507-033-12
 168410-050-00-82
 Verfügbare Farben/Oberflächen

 00 Roh	 00 Roh	 00 Roh	 08 Mattsilbereffekt	 10 Hochglanzpoliert	 12 Gebürstet
					
 17 Glanzverchromt	 18 Gebürstet, anodisiert	 19 Edstahleffekt	 20 Edstahleffekt	 21 Edstahleffekt	 30 KTL-beschichtet*
					
 33 RAL 7016 Anthrazitgrau, matt, glatt	 36 RAL 9006 Weissaluminium, satiniert, glatt	 80 RAL 9005 Schwarz, satiniert, strukturiert	Verfügbar für  Edelstahl  Aluminium  Zinkdruckguss  Stahl  Kunststoff		*E-coat (KTL), auch elektrophoretische Beschichtung genannt, ist eine dünne Schicht (15 µ), die Stahlprodukten einen Schutzfilm (Grundierung) verleiht. Nach der E-Beschichtung ist das Produkt bereit für die finale Oberflächenbehandlung, beispielsweise eine Lackierung oder eine Pulverbeschichtung.
					

Pulverbeschichtet

 32 RAL 9016 Weiss, satiniert, glatt	 33 RAL 7016 Anthrazitgrau, matt, strukturiert	 34 RAL 7047 Telegrau 4, satiniert, glatt	 82 RAL 9005 Schwarz, matt, strukturiert	 89 RAL 9005 Schwarz, matt, glatt
				

Alle rohen/unbehandelten Komponenten, die auf -00 enden, können in jeder RAL-Farbe pulverbeschichtet werden.



SETZEN SIE AKZENTE

ERHÄLTlich IN VERSCHIEDENEN OBERFLÄCHENAUSFÜHRUNGEN

Black Line umfasst ein vielfältiges Sortiment aus tiefschwarzen RAL 9005 Geländerkomponenten. Damit finden Sie immer die passende Lösung für Ihr nächstes Geländerprojekt – egal ob Glasklemmen, Glasadapter, Bodenprofile, Geländerpfosten oder Handläufe. Die aus hochwertigen Materialien hergestellten und perfekt verarbeiteten Komponenten sind so entwickelt, dass Sie sie leicht zusammenbauen und montieren können.



Reinigung und Pflege



Edelstahl ist aufgrund seiner Zusammensetzung äusserst korrosions- und kratzfest. Dennoch sollte er regelmässig gepflegt werden, insbesondere bei extremen Umwelteinflüssen. Wir empfehlen die komplette Oberfläche nach der Montage mit Q-ultra-clean zu behandeln. Dies hilft eine starke Passivschicht, dauerhaften Schutz und ein langanhaltendes, gutes Aussehen zu gewährleisten.

Verwendung	
Q-protector	Edelstahl + Aluminium
Q-ultra-clean	Edelstahl
Q-cleaner	Edelstahl (+ Aluminium)

Q-protector

Verwenden Sie dieses Langzeit-Schutzspray direkt nach der Montage Ihrer Edelstahl- oder Aluminiumgeländer. Es entfernt nicht nur Staub und Montagereste, sondern schützt das Geländer gleichzeitig – durch die Bildung einer Schutzschicht – auch vor Fingerabdrücken, Feuchtigkeit und Witterungseinflüssen. Und das Beste: die Komponenten müssen nach der Einwirkzeit nicht mit Wasser abgespült werden. Unser Q-protector sorgt für eine längere Lebensdauer Ihrer Edelstahl- oder Aluminiumgeländer und minimiert die Reinigungsintervalle.

Q-ultra-clean

Dieses Reinigungsspray wurde speziell für Edelstahl-Komponenten entwickelt. Es sollte direkt nach der Montage, präventiv oder bei auftretender Korrosion verwendet werden, da es hartnäckigen Schmutz und Oberflächenkorrosion entfernt. Es erneuert und stärkt ausserdem die Schutz-/Passivschicht des Edelstahls.

Q-cleaner

Q-cleaner hat eine entöhlende Wirkung und entfernt Flecken, Fingerabdrücke und Permanentmarker. Er ist ideal für den Einsatz während der Montage sowie als regelmässiger Reiniger zur Pflege des Geländers.

Andere Materialien, die für unsere Produkte verwendet werden – zum Beispiel Stahl und Zink – können mit warmem Seifenwasser gereinigt werden.

Anwendungsgebiete

Umgebungseinflüsse	Anwendung	Zinkdruckguss	Aluminium (gebürstet)	Aluminium (roh)	Aluminium (pulverbeschichtet)	Edelstahl (V2A)	Edelstahl (V4A)
						304	316
Niedrig	Innenbereich Nicht in Feuchträumen.	✓	✓	✓	✓	✓	✓
Moderat	Innenbereich Nicht an Orten mit nennenswerter Belastung durch Chlor- oder Schwefeldioxid (z. B. Chemiefabriken)	✓	✓	✓	✓	✓	✓
Medium	Aussenbereich Orte mit mässiger Chlor- und Schwefeldioxidbelastung (z.B. Binnenland, mindestens 25 km Entfernung zur Küste oder anderen wasserreichen Umgebungen)	!	✓	✗	✗	✗	✓
Hoch	Aussenanwendung Orte mit einem hohen Grad an Korrosionsbildung durch Chlor- und/oder Schwefeldioxidbelastung, hoher Luftfeuchtigkeit oder einer Ansammlung schädlicher Substanzen (z. B. in Küstenregionen oder in direkter Umgebung von Swimmingpools).	✗	✓	✗	✗	✗	✓ 

✓ = Geeignet

! = Geeignet, erfordert aber besondere Aufmerksamkeit/Beratung

✗ = Nicht geeignet



PREFIX MACHT DAS LEBEN LEICHTER

Eine perfekte Vorbereitung ist der Schlüssel zum Erfolg. Nutzen Sie daher unseren zeit- und kostensparenden Vorfertigungsservice beim Kauf Ihrer Geländerlösung von Q-railing. Sie erhalten alles zu 100% montagefertig.

PREFIX Prefix-Optionen verfügbar.

Biegen
Wir bieten 2D- und 3D-Biegearbeiten an Rohren, Glasleistenrohren, U-Profilen, Kantenschutzprofilen und sogar Easy Glass® Bodenprofilen an. Unser akkurater Service stellt sicher, dass Sie genau die Grössen und Radien erhalten, die Sie benötigen.

Zuschneiden und Fräsen
Maximalen Komfort bietet auch unser Zuschnittservice für Elemente aus Edelstahl, Aluminium und Holz. Dies umfasst Handläufe, Glasleistenrohre, Pfosten und Easy Glass® Bodenprofile. Wir können Ihre Produkte zudem auf Gehrung zuschneiden oder mit vorgefrästen Löchern, z.B. für LED-Spotlights, liefern.

Bohren und Gewindeschneiden
Überlassen Sie uns alle notwendigen Bohrarbeiten: Nach Ihren genauen Vorgaben versehen wir Pfosten und andere Geländerelemente mit sämtlichen Löchern und Gewinden, die Sie für die Installation benötigen.

Schweissen
In seltenen Fällen müssen die Standardprodukte von Q-railing geschweisst werden, um eine bestimmte Einbausituation zu erfüllen. Gerne schweissen wir Ihre massgefertigten Produkte vor und liefern sie montagefertig an.

Pulverbeschichtung
Lassen Sie Bodenprofile, Glasleistenrohre, Endkappen oder andere Geländerkomponenten in der RAL-Farbe Ihrer Wahl pulverbeschichten. Geben Sie dies einfach bei Ihrer Bestellung an und wir liefern die gewünschten Artikel farblich passend für Ihr Geländerprojekt.

Vormontage
Nutzen Sie einfach unseren Prefix-Service, um Q-railing Produkte nach Ihren Wünschen vormontieren zu lassen. Erleben Sie, wie viel Zeit Sie sparen können, wenn z. B. Glasklemmen oder Querstabhalter bereits vorinstalliert sind.

Nutzen Sie die Online-Formulare, um unseren Vorfertigungsservice zu nutzen. Oder sprechen Sie uns an - wir helfen Ihnen gerne weiter.

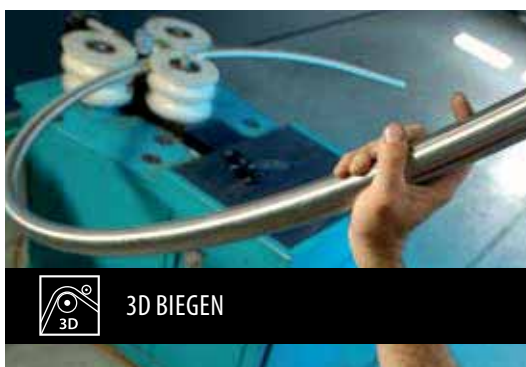



1

GANZGLAS- GELÄNDER- SYSTEME

Easy Glass® Smart	28 - 49
Easy Glass® Smart+	50 - 61
Easy Glass® Prime	62 - 81
Easy Glass® Strong	82 - 93
Easy Glass® Slim	94 - 103
Easy Glass® Pro	104 - 115
Easy Glass® Max	116 - 125
Easy Glass® Up	126 - 133
Easy Glass® Hybrid	134 - 139
Easy Glass® Bodenglasklemmen	140 - 145
Easy Glass® Air	146 - 149
Easy Glass® Glasadapter	150 - 164



Beanspruchung: Leicht und mittel
Verwendung: Innen- und Aussenbereich
Montage: Boden-, In-Boden- und Seitenmontage
Anwendung: Balkone, Galerien, Wege, Abtrennungen, Treppen und französische Balkone
Material: Aluminium (gebürstet anodisiert, roh und pulverbeschichtet in RAL 9005 schwarz)
Glasstärke: 12 bis 21,52 mm

Finden Sie alle Informationen zu Easy Glass Smart online:



<https://q-ne.ws/Smart23>

EASY GLASS® SMART



red dot winner 2020
 innovative product

Unschlagbar einfache Installation



Easy Glass® Smart beinhaltet das revolutionäre Q-disc® System. Die Kombination aus Inlay und Q-disc ermöglicht eine extrem schnelle Glasmontage. Installieren Sie das Bodenprofil, positionieren Sie das Glas und fixieren Sie anschliessend mit nur einer einzigen Handbewegung jede Scheibe sicher im Profil. Mit der justierbaren Variante des Q-disc Systems können Sie zudem jede einzelne Glasscheibe in der Vertikalen ausrichten. Ein zusätzliches Feature sind die Easy Glass Bauanschlussleisten für eine nahtlose Verbindung mit dem angrenzenden Boden. Diese sorgen für ein stilvolles Finish und einen erhöhten Materialschutz.

Easy Glass® Smart	CH
Max. Holmlast (kN/m)	1.6



Bitte beachten Sie die Spezifikationen wie Befestigungs- und Glasmasse sowie Glastypen der jeweiligen Zertifikate.

International getestet/berechnet/zertifiziert:



- 1 Mit dem justierbaren Q-disc System können Sie die Glasfüllung nicht nur fixieren, sondern auch um 0,6° in der Vertikalen ausrichten.
- 2 Mit einem Klickgeräusch signalisiert die Q-disc die korrekte Installation.
- 3 Geeignet für Glasstärken zwischen 12 und 21,52 mm.

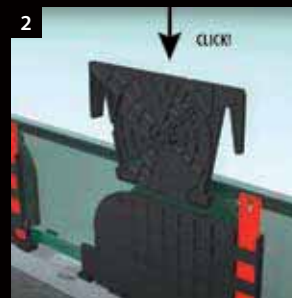
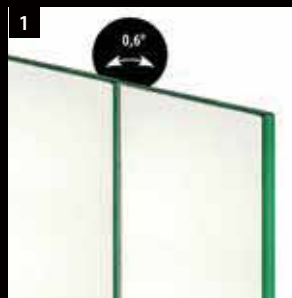

EASY GLASS® SMART MONTAGEOPTIONEN

Smart

Bodenmontage

- Auch für die In-Bodenmontage

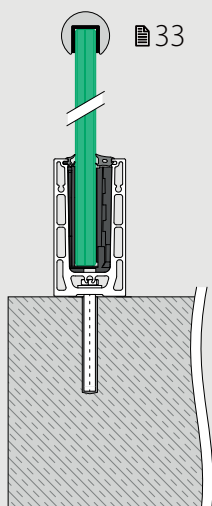

Smart F

Bodenmontage

- Für Rohfussböden
- Kann direkt an oder über der Bodenkante angebracht werden

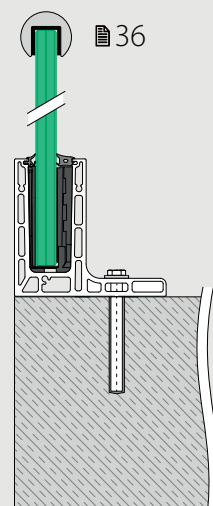

Smart

Seitenmontage

- Auch zur Montage an der Innenseite von Aufmauerungen
- Bodenprofil-Blendeleiste erhältlich

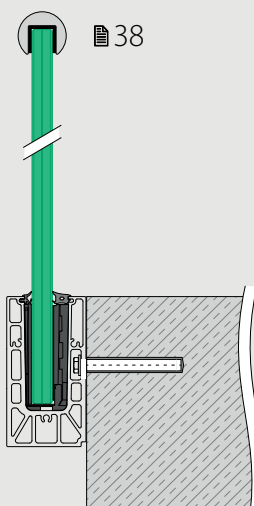

Smart Y

Seitenmontage

- Für Rohfussböden
- Kann direkt an oder über der Bodenkante angebracht werden
- Bodenprofil-Blendeleiste erhältlich

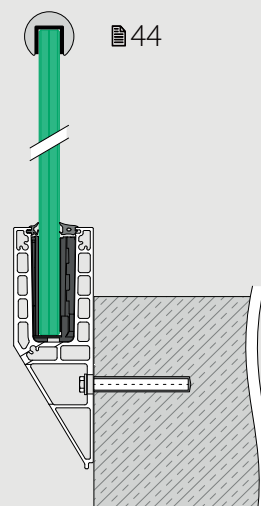



JUSTIERBARES Q-DISC® SYSTEM SCHIEBEN UND AUSRICHTEN!



SO FUNKTIONIERT'S

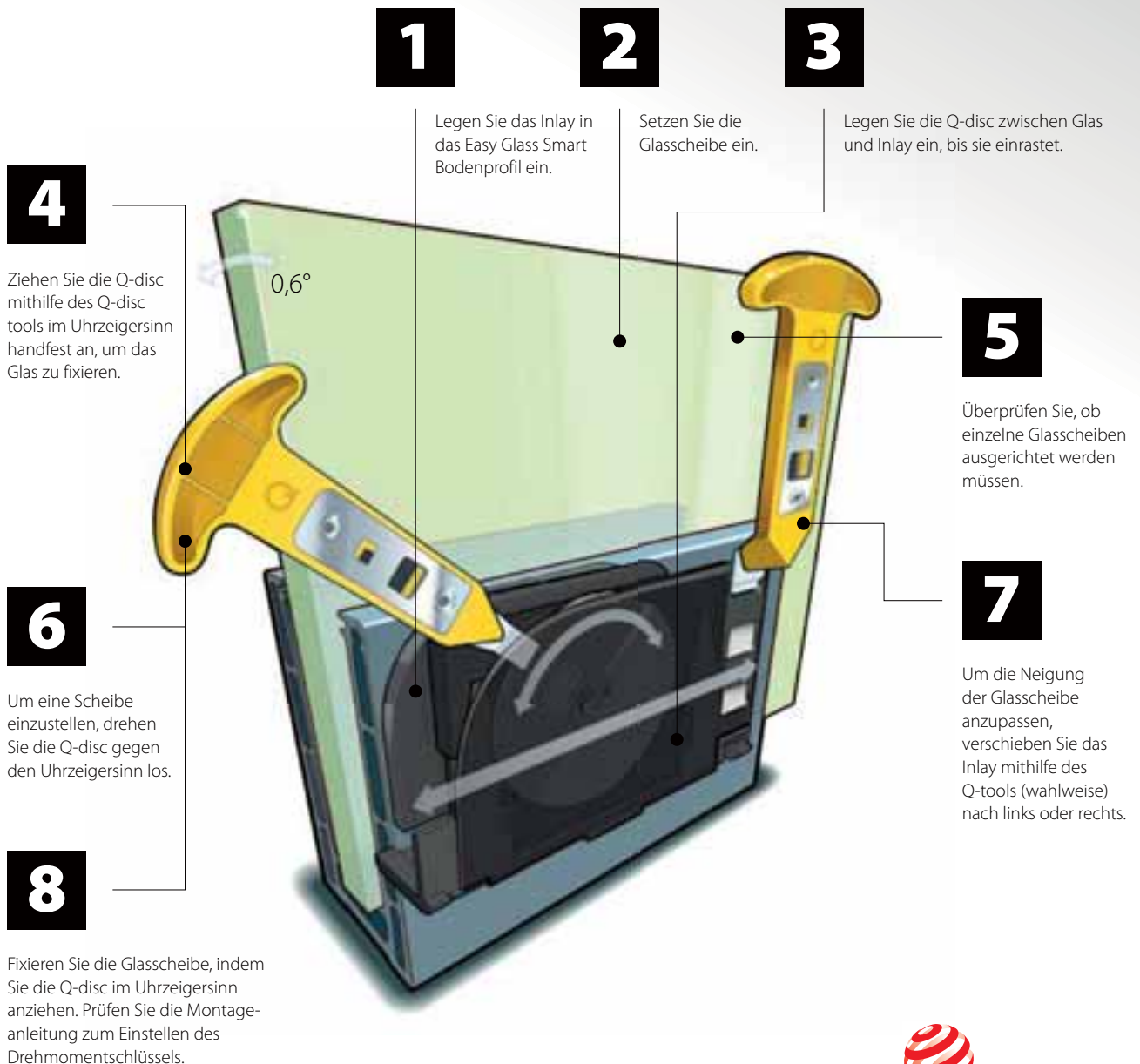

reddot winner 2020
innovative product

Q-disc® System (Gummi, Inlay und Q-disc®)

Glasklemmung und -justierung

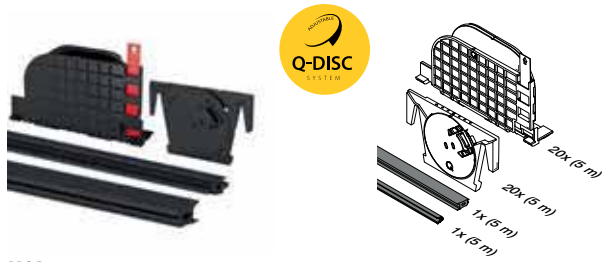

MOD 8201

Zubehör		
Für monolithisches Glas	T	
208201-050-12	12	L = 5 m
208201-050-15	15	L = 5 m
208201-250-12	12	L = 25 m
208201-250-15	15	L = 25 m
Für laminiertes Glas		
208201-050-13	12,76	L = 5 m
208201-050-14	13,52	L = 5 m
208201-050-17	16,76	L = 5 m
208201-050-18	17,52	L = 5 m
208201-250-13	12,76	L = 25 m
208201-250-14	13,52	L = 25 m
208201-250-17	16,76	L = 25 m
208201-250-18	17,52	L = 25 m



Internationaler Geschmacksmusterschutz

Einzelne Gummis



MOD 8207

Zubehör	
208207-250-00	L = 25 m



MOD 8207

Zubehör		
Für monolithisches Glas	T	
208207-250-12	12	L = 25 m
208207-250-15	15	L = 25 m

Für laminiertes Glas

208207-250-14	12,76 - 13,52	L = 25 m
208207-250-18	16,76 - 17,52	L = 25 m



Q-disc®-Sets

Glasklemmung und -justierung

Q-disc®- und Inlay-Werkzeug



MOD 1000

Zubehör		
	Q	
201000	Q-84	1

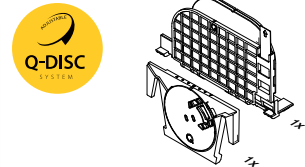

MOD 8209

Zubehör		
Für monolithisches Glas	T	
208209-12	12	5
208209-15	15	5

Für laminiertes Glas

208209-13	12,76	5
208209-14	13,52	5
208209-17	16,76	5
208209-18	17,52	5



Q-INFO MOD 1000

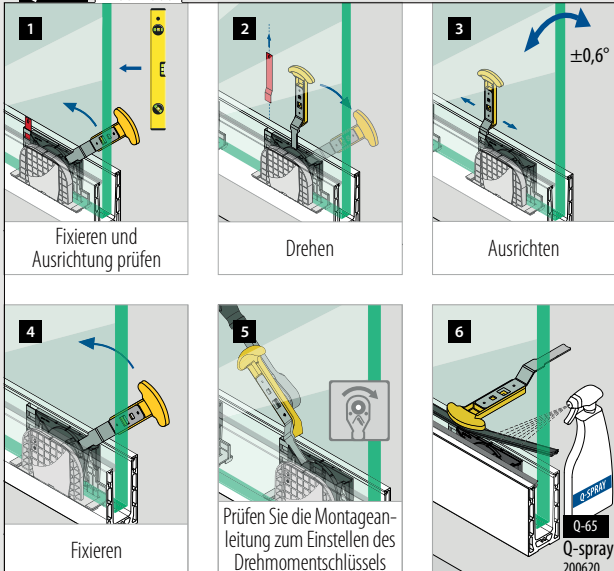

Q-INFO

Installationsblech

MOD 1002

480



Geländerbasis

Q-disc® System (Gummi, Inlay und Q-disc®)

Glasklemmung (nicht justierbar)

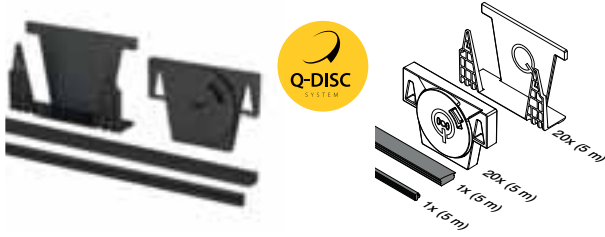

MOD 8200

Zubehör

Für monolithisches Glas		
	T	
SELL OUT 208200-050-12	12	L = 5 m
SELL OUT 208200-050-15	15	L = 5 m
SELL OUT 208200-050-19	19	L = 5 m

Für laminiertes Glas

SELL OUT 208200-050-13	12,76 - 13,52	L = 5 m
SELL OUT 208200-050-17	16,76 - 17,52	L = 5 m
SELL OUT 208200-050-21	20,76 - 21,52	L = 5 m

SELL OUT 208200-250-13	12,76 - 13,52	L = 25 m
SELL OUT 208200-250-17	16,76 - 17,52	L = 25 m
SELL OUT 208200-250-21	20,76 - 21,52	L = 25 m



Internationaler Geschmacksmusterschutz

Zubehör

Q-disc®- und Inlay-Werkzeug



MOD 1000

Zubehör

	Q	
201000	Q-84	1

Nur solange der Vorrat reicht.

Zubehör

Einzelne Gummis



MOD 8206

Zubehör

208206-250-00		L = 25 m
---------------	--	----------

NEW



MOD 8206

Zubehör

Für laminiertes Glas		
	T	
208206-250-13	12,76 - 13,52	L = 25 m
208206-250-17	16,76 - 17,52	L = 25 m
208206-250-21	20,76 - 21,52	L = 25 m

NEW

Zubehör

Q-disc®-Sets

Glasklemmung (nicht justierbar)

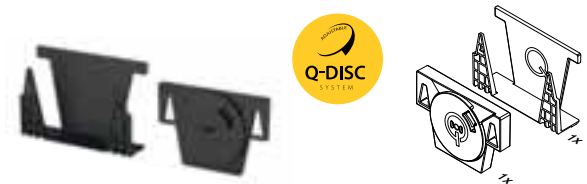

MOD 8208

Zubehör

Für monolithisches Glas		
	T	
208208-12	12	5
208208-15	15	5
208208-19	19	5

Für laminiertes Glas

208208-13	12,76 - 13,52	5
208208-17	16,76 - 17,52	5
208208-21	20,76 - 21,52	5

NEW



Q-INFO | MOD 1000

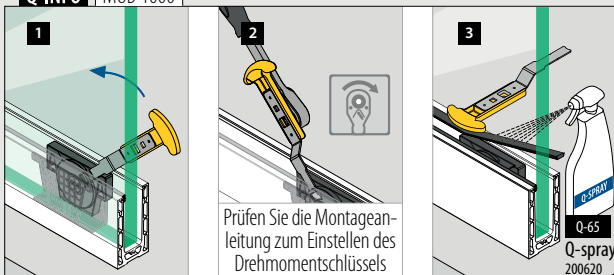

Bodenprofile zur Bodenmontage

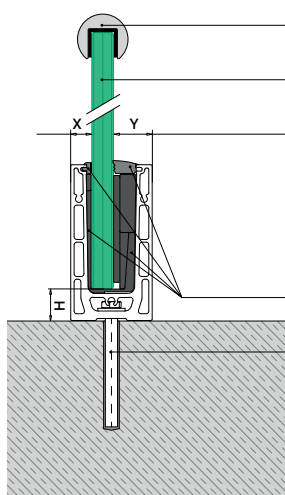

Glasleistenrohre: ■ 169 - 185
Kantenschutz: ■ 166 - 168

VSG gemäss Statik

Glasklemmung und -justierung
X = variabel
Y = 25,5
H = 25

Zur nicht justierbaren Glasklemmung
X = 15
Y = variabel
H = 23

Q-disc® System: ■ 31, 32

Anker: ■ 457 - 463

Bitte beachten Sie die Spezifikationen wie Befestigungs- und Glasmasse sowie Glastypen der jeweiligen Zertifikate und statischen Berechnungen.

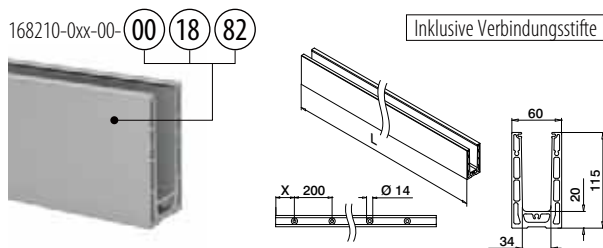

MOD 8210

Aluminium	Roh		
	X		
168210-050-00-00	100	■ 457 - 463	L = 5 m
Aluminium	Gebürstet		
OUTDOOR			
168210-025-00-18	50	■ 457 - 463	L = 2,5 m
168210-050-00-18	100	■ 457 - 463	L = 5 m
Aluminium	Black Line		
OUTDOOR			
NEW	168210-050-00-82	100	■ 457 - 463 L = 5 m



Internationaler Geschmacksmusterenschutz

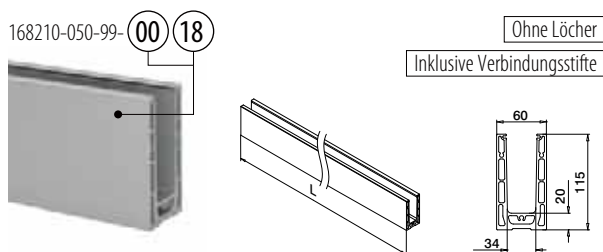

MOD 8210

Aluminium	Roh		
168210-050-99-00			L = 5 m
Aluminium	Gebürstet		
OUTDOOR			
168210-050-99-18			L = 5 m



Internationaler Geschmacksmusterenschutz

Q-INFO

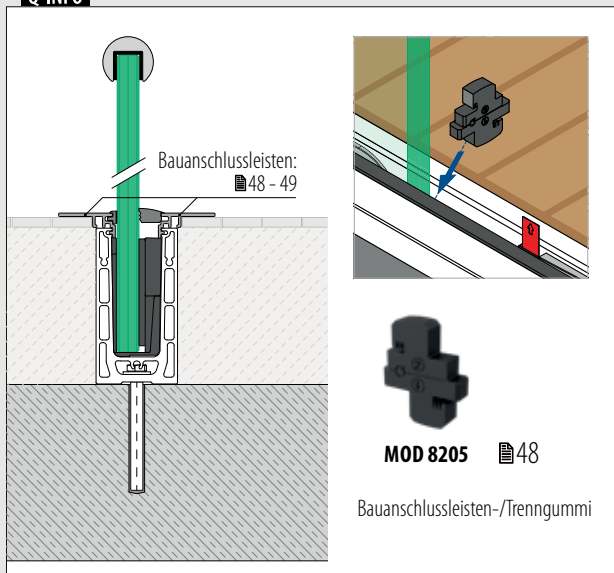

MOD 8205 ■ 48

Bauanschlussleisten-/Trenngummi

Q-INFO

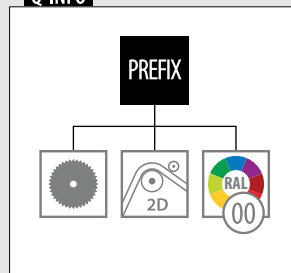

Q-INFO



Q-INFO Aluminium



Geländerbasis

Ecken zur Bodenmontage

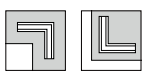

Innen- und Aussenecke

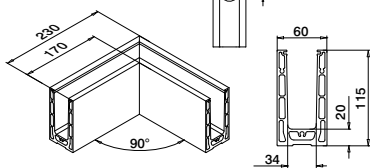

MOD 8211

Aluminium	Roh		
168211-00-00		457 - 463	1
Aluminium	Gebürstet		
OUTDOOR			
168211-00-18		457 - 463	1
Aluminium	Black Line		
OUTDOOR			
NEW	168211-00-82	457 - 463	1



Internationaler Geschmacksmusterschutz

Geländerbasis

Endkappen zur Bodenmontage



Links / rechts

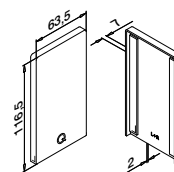

MOD 8212

Aluminium	Roh	Klebeband	
168212-00-00		Beigelegt	1
Aluminium	Gebürstet		
OUTDOOR			
168212-00-18		Angebracht	1
Aluminium	Black Line		
OUTDOOR			
NEW	168212-00-82	Beigelegt	1

Q-INFO MOD 8212

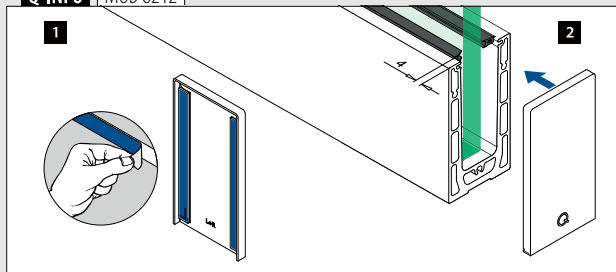

Q-INFO Aluminium



Endkappen zur Bodenmontage

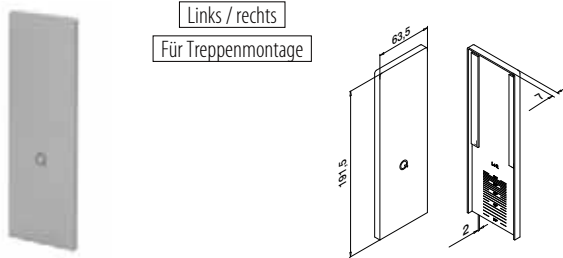

MOD 8213

Aluminium	Roh		
		Klebeband	
168213-00-00	Beigelegt		1
Aluminium	Gebürstet		
		OUTDOOR	
168213-00-18	Angebracht		1



Unterlegscheiben zur Bodenmontage

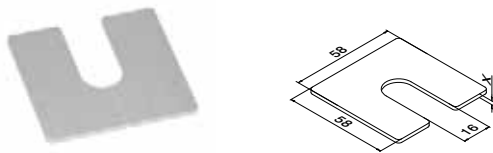

MOD 8216

Aluminium	Roh		
		X	
168216-001	1		100
168216-002	2		100
168216-003	3		100

Drainageleisten zur Bodenmontage

4 Stück für 2,5-Meter-Bodenprofil
8 Stück für 5-Meter-Bodenprofil

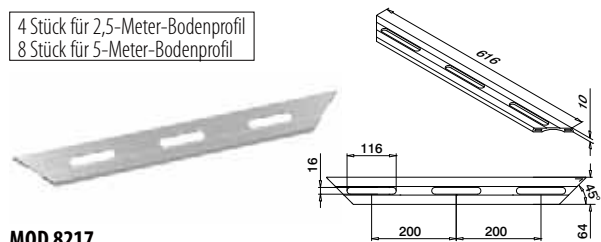

MOD 8217

Aluminium	Gebürstet		
		OUTDOOR	
168217-18			4

Q-INFO MOD 8213

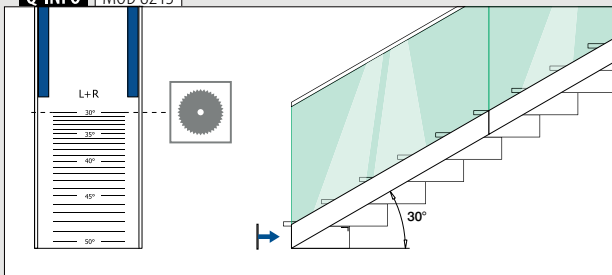

Q-INFO MOD 8216

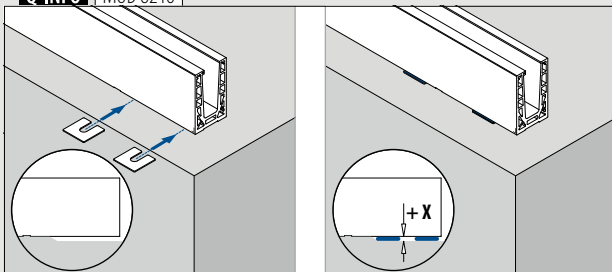

Q-INFO MOD 8217

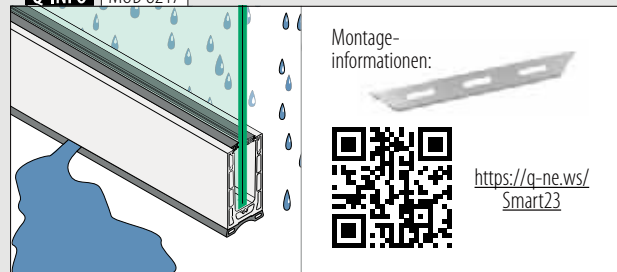

Bodenprofile zur Bodenmontage

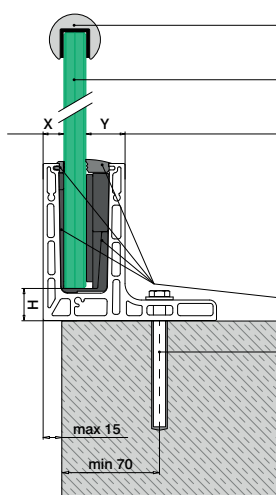

Glasleistenrohre: ■ 169 - 185
Kantenschutz: ■ 166 - 168

VSG gemäss Statik

Glasklemmung und -justierung
X = variabel
Y = 25,5
H = 25

Zur nicht justierbaren Glasklemmung
X = 15,5
Y = variabel
H = 23

Q-disc® System: ■ 31, 32

Anker: ■ 457 - 463

Bitte beachten Sie die Spezifikationen wie Befestigungs- und Glasmasse sowie Glastypen der jeweiligen Zertifikate und statischen Berechnungen.

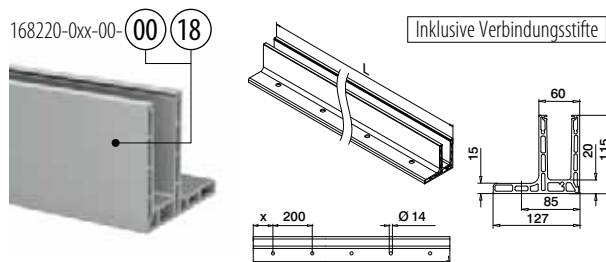

MOD 8220

Aluminium	Roh		
	X		
168220-050-00-00	100	■ 457 - 463	L = 5 m
Aluminium	Gebürstet		
OUTDOOR			
168220-025-00-18	50	■ 457 - 463	L = 2,5 m
168220-050-00-18	100	■ 457 - 463	L = 5 m



Internationaler Geschmacksmusterschutz

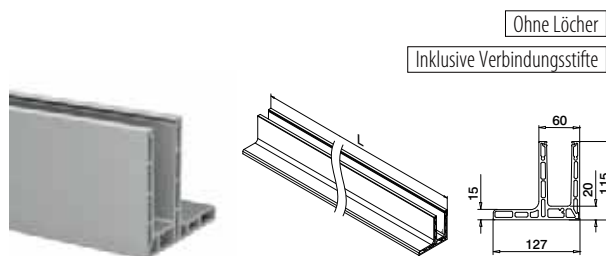

MOD 8220

Aluminium	Gebürstet		
168220-050-99-18			L = 5 m



Internationaler Geschmacksmusterschutz

Q-INFO

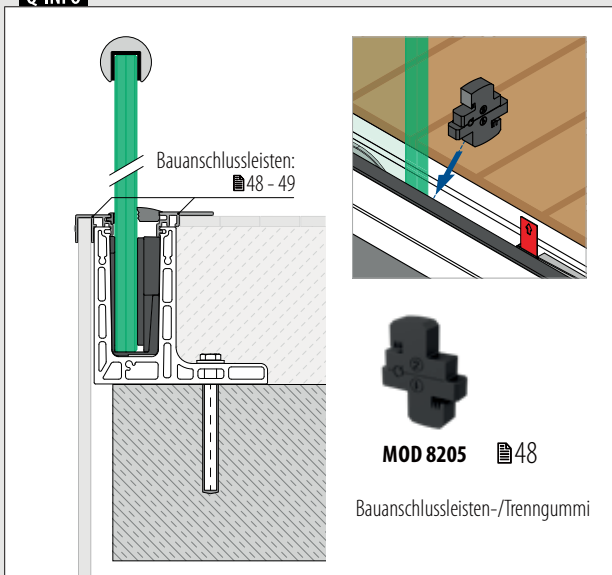

MOD 8205 ■ 48
Bauanschlussleisten-/Trenngummi

Q-INFO

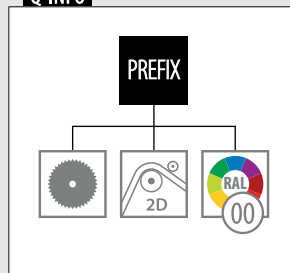

Q-INFO Aluminium



Q-INFO

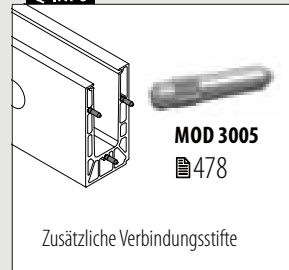

Ecken zur Bodenmontage

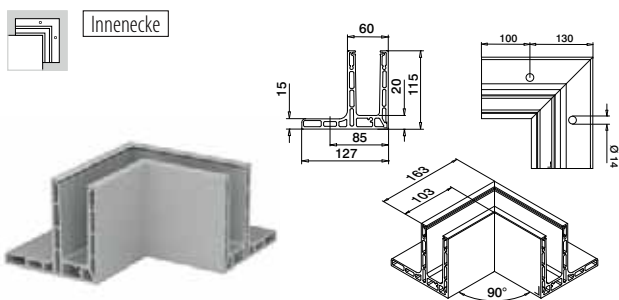

MOD 8221

Aluminium	Gebürstet		
OUTDOOR			
168221-01-18	457 - 463		1



Internationaler Geschmacksmusterschutz

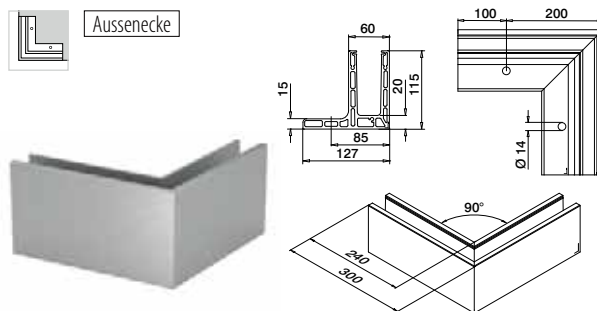

MOD 8221

Aluminium	Gebürstet		
OUTDOOR			
168221-02-18	457 - 463		1



Internationaler Geschmacksmusterschutz

Endkappen zur Bodenmontage

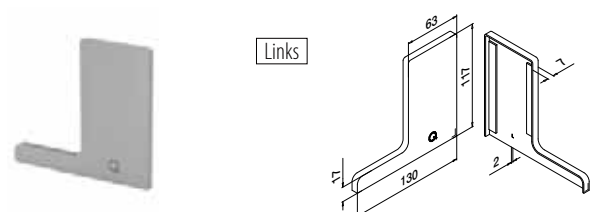

MOD 8222

Aluminium	Roh		
Klebeband			
168222-01-00	Beigelegt		1
Aluminium	Gebürstet		
OUTDOOR			
168222-01-18	Angebracht		1

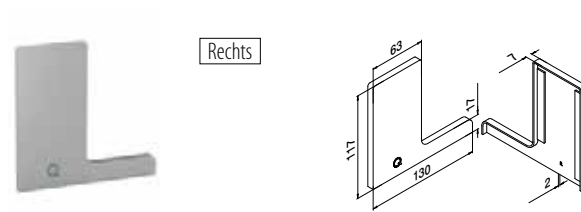

MOD 8222

Aluminium	Roh		
Klebeband			
168222-02-00	Beigelegt		1
Aluminium	Gebürstet		
OUTDOOR			
168222-02-18	Angebracht		1

Wasserdichte Verkleidungen

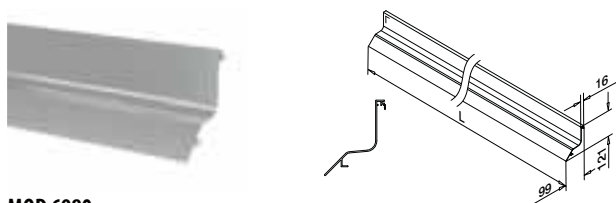

MOD 6980

Aluminium	Roh		
Klebeband			
166980-50-00	Nicht inkl.*		1
Aluminium	Gebürstet		
OUTDOOR			
166980-50-18	Nicht inkl.*		1



*Bestellen Sie MOD 1360 (Klebeband)

Acrylat-Klebeband



MOD 1360

Zubehör				
201360	Q-53	9	33 m	1

Q-INFO MOD 8222

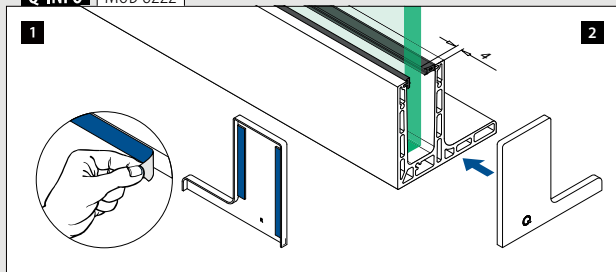

Q-INFO MOD 6980

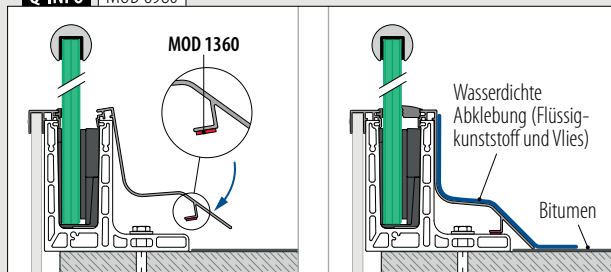

Geländerbasis

Bodenprofile zur Seitenmontage

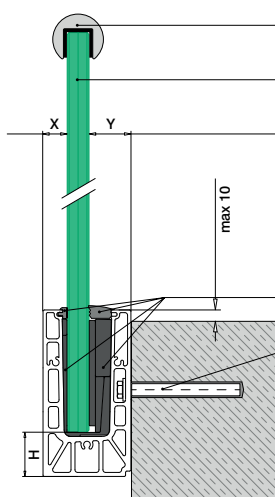

Glasleistenrohre: ■ 169 - 185
Kantenschutz: ■ 166 - 168

VSG gemäss Statik

Glasklemmung und -justierung
X = variabel
Y = 28,5
H = 35

Zur nicht justierbaren Glasklemmung
X = 18,5
Y = variabel
H = 33

Q-disc® System: ■ 31, 32

Anker: ■ 457 - 463

Bitte beachten Sie die Spezifikationen wie Befestigungs- und Glasmasse sowie Glastypen der jeweiligen Zertifikate und statischen Berechnungen.

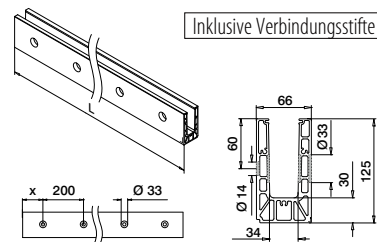

Inklusive Verbindungsstifte

MOD 8230

Aluminium	Roh	X	■ 457 - 463	L = 5 m
168230-050-00-00		100		
Aluminium	Gebürstet			
OUTDOOR				
168230-025-00-18		50	■ 457 - 463	L = 2,5 m
168230-050-00-18		100	■ 457 - 463	L = 5 m



Internationaler Geschmacksmusterschutz

Geländerbasis

Ecken zur Seitenmontage

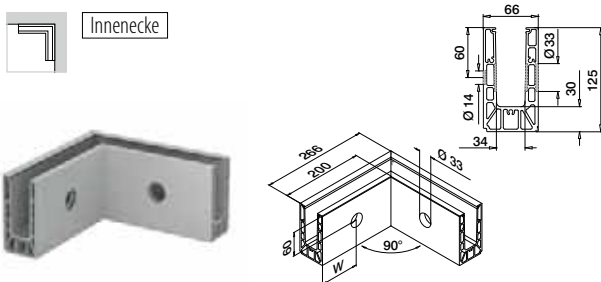

MOD 8231

Aluminium	Roh	W	■ 457 - 463	1
168231-01-00		100*		
Aluminium	Gebürstet			
OUTDOOR				
168231-01-18		100*	■ 457 - 463	1



Internationaler Geschmacksmusterschutz

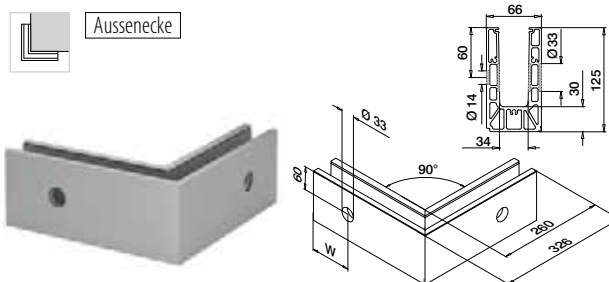

MOD 8231

Aluminium	Roh	W	■ 457 - 463	1
168231-02-00		100*		
Aluminium	Gebürstet			
OUTDOOR				
168231-02-18		100*	■ 457 - 463	1



Internationaler Geschmacksmusterschutz

*Die Lochposition kann produktionsbedingt abweichen.

Q-INFO MOD 8230

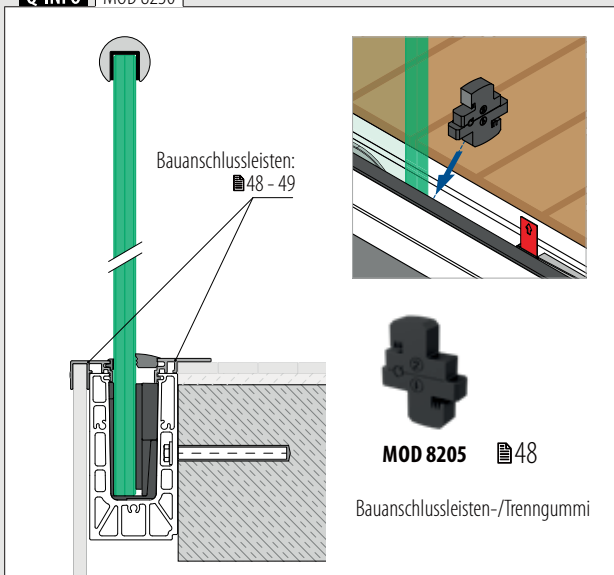

MOD 8205 ■ 48

Bauanschlussleisten-/Trenngummi

Q-INFO MOD 8230

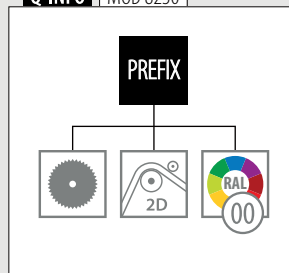

Q-INFO Aluminium



Q-INFO

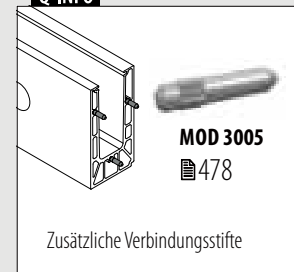

Zusätzliche Verbindungsstifte

Endkappen zur Seitenmontage

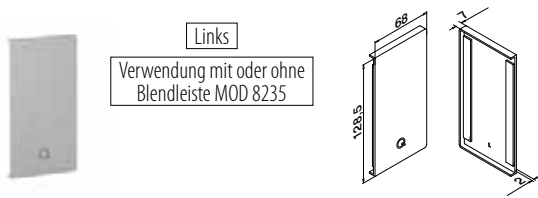

MOD 8232

Aluminium	Roh		
	Klebeband		
168232-01-00	Beigelegt	1	
Aluminium	Gebürstet		
OUTDOOR			
168232-01-18	Angebracht	1	

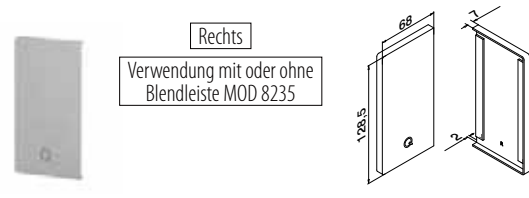

MOD 8232

Aluminium	Roh		
	Klebeband		
168232-02-00	Beigelegt	1	
Aluminium	Gebürstet		
OUTDOOR			
168232-02-18	Angebracht	1	

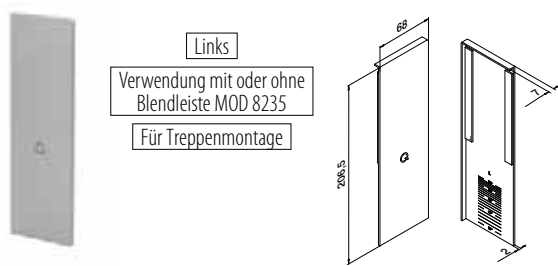

MOD 8233

Aluminium	Roh		
	Klebeband		
168233-01-00	Beigelegt	1	
Aluminium	Gebürstet		
OUTDOOR			
168233-01-18	Angebracht	1	

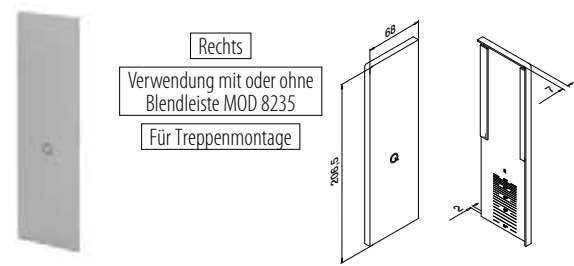

MOD 8233

Aluminium	Roh		
	Klebeband		
168233-02-00	Beigelegt	1	
Aluminium	Gebürstet		
OUTDOOR			
168233-02-18	Angebracht	1	



Q-INFO Aluminium

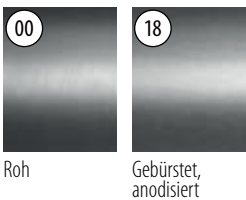

Q-INFO MOD 8232 / 8233

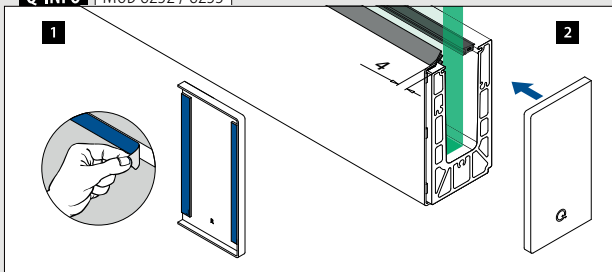

Q-INFO MOD 8233

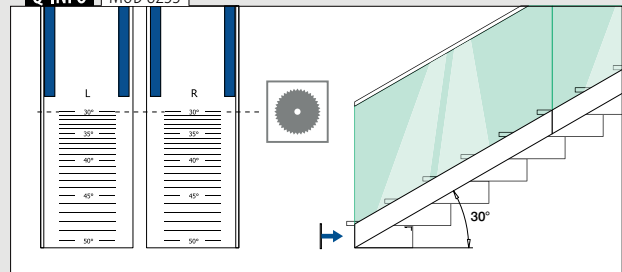

Endkappen zur Seitenmontage

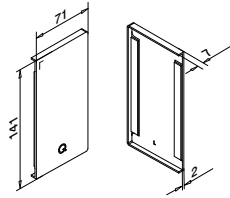

Links
Für MOD 8234

**MOD 8232**

Aluminium	Roh	Klebeband	
168232-41-00	Beigelegt		1
Aluminium	Gebürstet	OUTDOOR	
168232-41-18	Angebracht		1

NEW

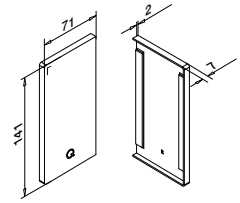

Rechts
Für MOD 8234

**MOD 8232**

Aluminium	Roh	Klebeband	
168232-42-00	Beigelegt		1
Aluminium	Gebürstet	OUTDOOR	
168232-42-18	Angebracht		1

NEW

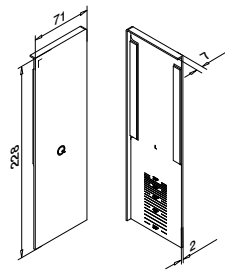

Links
Für MOD 8234
Für Treppenmontage

**MOD 8233**

Aluminium	Gebürstet	Klebeband	
168233-41-18	Angebracht		1

NEW

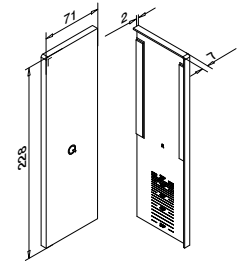

Rechts
Für MOD 8234
Für Treppenmontage

**MOD 8233**

Aluminium	Gebürstet	Klebeband	
168233-42-18	Angebracht		1

NEW

**Q-INFO Aluminium**

00

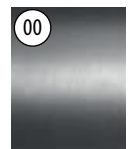

Roh

18

Gebürstet,
anodisiert

Drainageleisten zur Seitenmontage

4 Stück für 2,5-Meter-Bodenprofil
8 Stück für 5-Meter-Bodenprofil

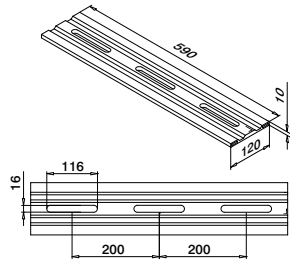

MOD 8237

Aluminium Gebürstet
OUTDOOR

168237-18



4

Blendstopfen zur Seitenmontage



Verwendung
ohne Blendleiste

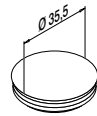

MOD 8238

Kunststoff Aluminium RAL 9006
INDOOR

158238-36



10

Unterlegscheiben zur Seitenmontage

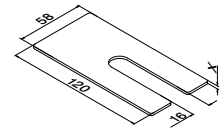

MOD 8236

Aluminium Roh

	X	
168236-001	1	100
168236-002	2	100
168236-003	3	100

Glas-Stopp



Für Treppenmontage

MOD 8204

Zubehör

208204



1

NEW

Q-INFO MOD 8237

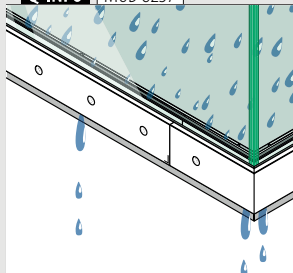

Montage-
informationen:



[https://q-ne.ws/
Smart23](https://q-ne.ws/Smart23)



Q-INFO MOD 8236

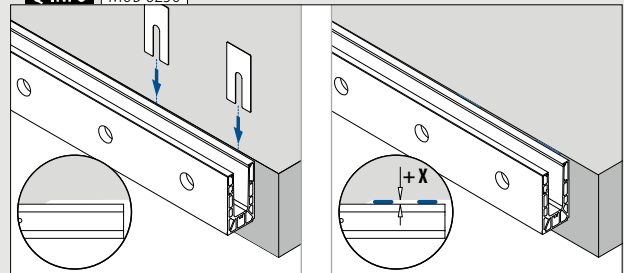

Q-INFO MOD 8238

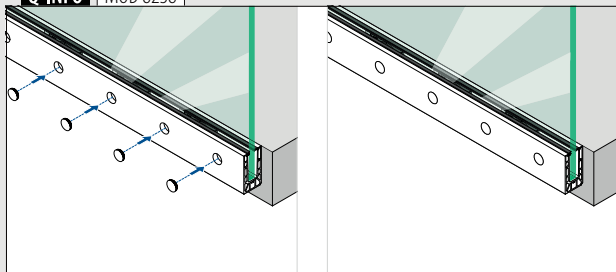

Q-INFO MOD 8204

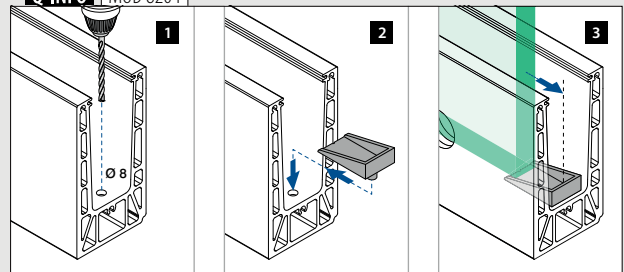

Geländerbasis

Blendleisten zur Seitenmontage

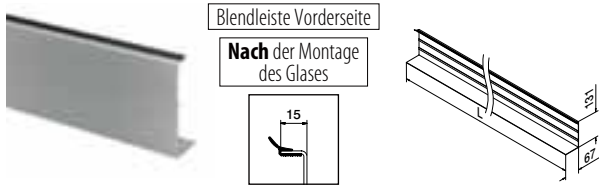

MOD 8235

Aluminium Roh		Klebeband	
SELL OUT	168235-050-00	Nicht inkl.*	L = 5 m
Aluminium Gebürstet			
OUTDOOR			
SELL OUT	168235-050-18	Angebracht	L = 5 m



*Bestellen Sie MOD 1360 (Klebeband)

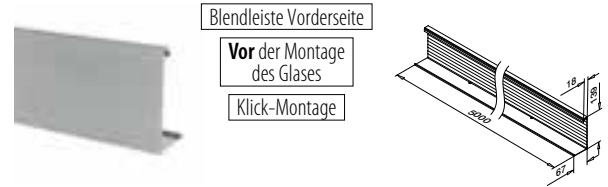

MOD 8234

Aluminium Roh		
	168234-050-00	L = 5 m
Aluminium Gebürstet		
OUTDOOR		
	168234-050-18	L = 5 m



Zubehör

Acrylat-Klebeband



MOD 1360

Zubehör					
	Q	W	L		
201360	Q-53	9	33 m (für 11 m Blendleiste)		1

SELL OUT Nur solange der Vorrat reicht.

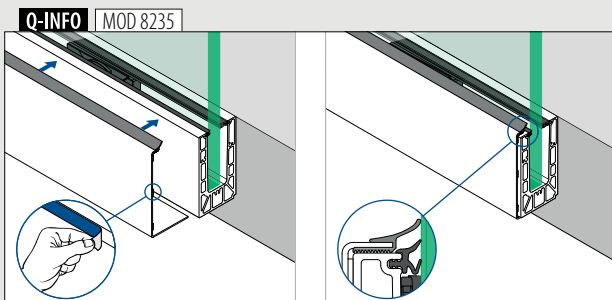

Q-INFO MOD 8235-050-00 / 1360

Montage-Informationen:

<https://q-ne.ws/Smart23>

Q-INFO Aluminium

Roh Gebürstet, anodisiert

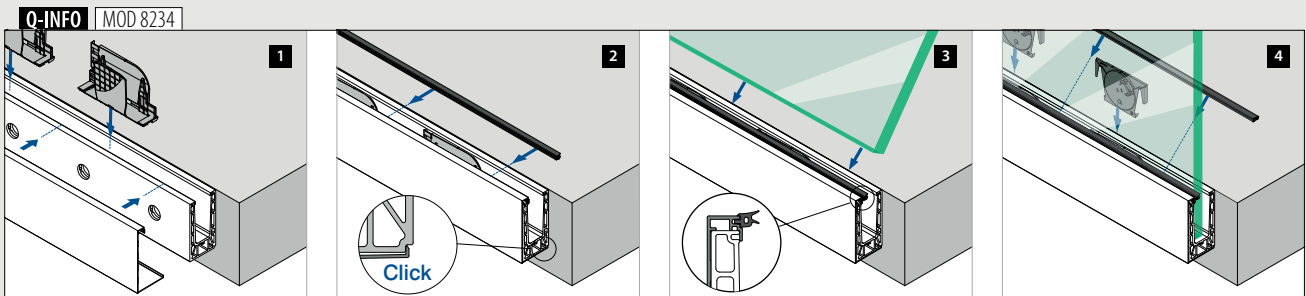



Bodenprofile zur Seitenmontage

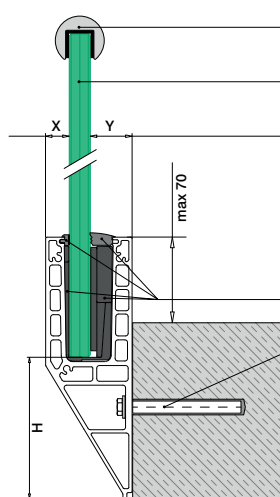

Glasleistenrohre: ■ 169 - 185
Kantenschutz: ■ 166 - 168

VSG gemäss Statik

Glaskehlung und -justierung
X = variabel
Y = 28,5
H = 110

Zur nicht justierbaren Glaskehlung
X = 18,5
Y = variabel
H = 108

Q-disc® System: ■ 31, 32

Anker: ■ 457 - 463

Bitte beachten Sie die Spezifikationen wie Befestigungs- und Glasmasse sowie Glastypeen der jeweiligen Zertifikate und statischen Berechnungen.

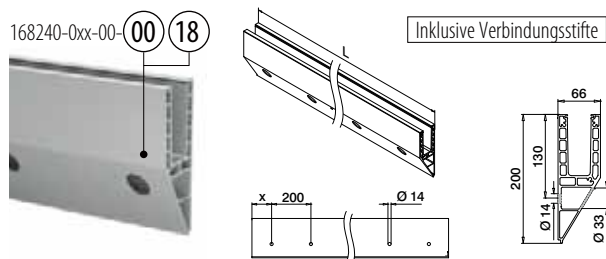

MOD 8240

Aluminium Roh	X		
168240-050-00-00	100	■ 457 - 463	L = 5 m
Aluminium Gebürstet			
OUTDOOR			
168240-025-00-18	50	■ 457 - 463	L = 2,5 m
168240-050-00-18	100	■ 457 - 463	L = 5 m



Internationaler Geschmacksmusterschutz

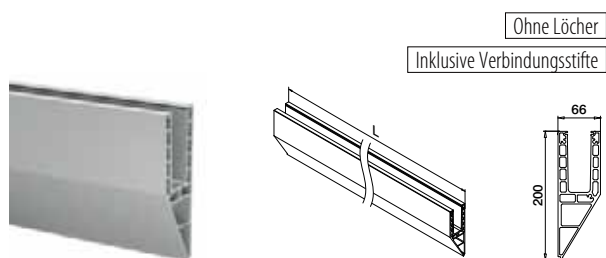

MOD 8240

Aluminium Gebürstet			
168240-050-99-18		■ 457 - 463	L = 5 m



Internationaler Geschmacksmusterschutz

Q-INFO

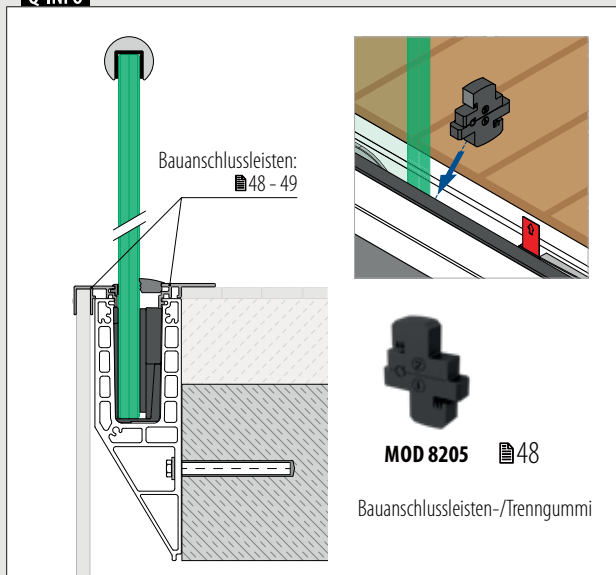

Bauanschlussleisten: ■ 48 - 49

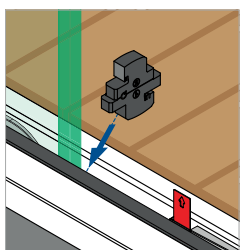

MOD 8205 ■ 48

Bauanschlussleisten-/Trenngummi

Q-INFO

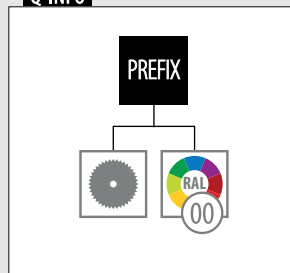

Q-INFO Aluminium



Roh

Gebürstet, anodisiert

Q-INFO

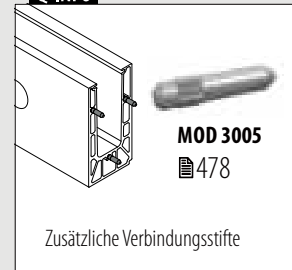

MOD 3005
■ 478

Zusätzliche Verbindungsstifte

Ecken zur Seitenmontage

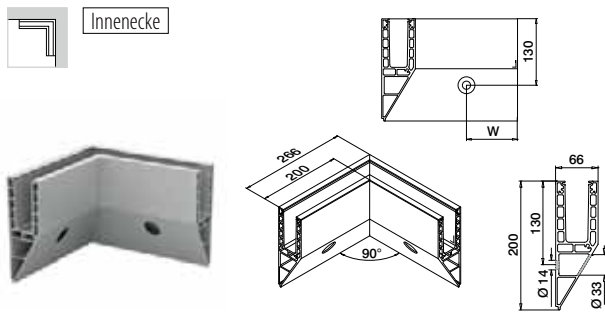

MOD 8241

Aluminium	Gebürstet		
OUTDOOR	W		
168241-01-18	100*	457 - 463	1



Internationaler Geschmacksmusterschutz

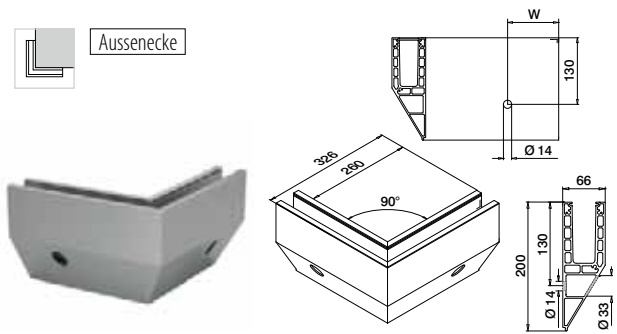

MOD 8241

Aluminium	Gebürstet		
OUTDOOR	W		
168241-02-18	100*	457 - 463	1



Internationaler Geschmacksmusterschutz

*Die Lochposition kann produktionsbedingt abweichen.

Endkappen zur Seitenmontage

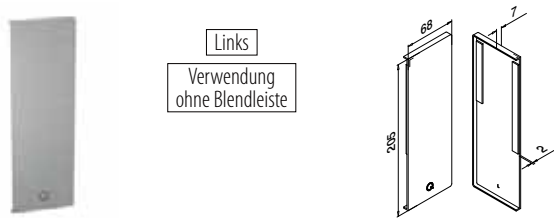

MOD 8242

Aluminium	Roh		
	Klebeband		
168242-01-00	Beigelegt		1
Aluminium	Gebürstet		
OUTDOOR			
168242-01-18	Angebracht		1

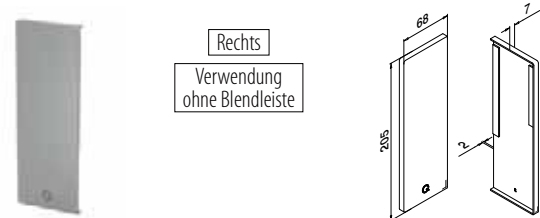

MOD 8242

Aluminium	Roh		
	Klebeband		
168242-02-00	Beigelegt		1
Aluminium	Gebürstet		
OUTDOOR			
168242-02-18	Angebracht		1

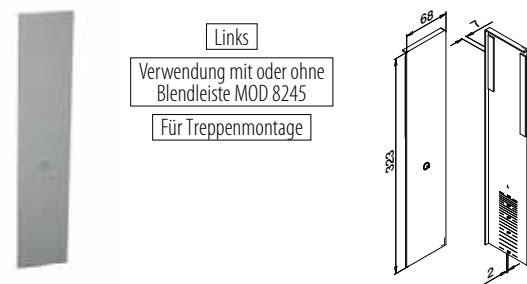

MOD 8243

Aluminium	Gebürstet		
	Klebeband		
168243-01-18	Angebracht		1

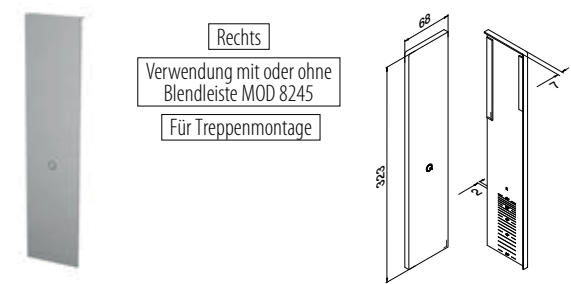

MOD 8243

Aluminium	Gebürstet		
	Klebeband		
168243-02-18	Angebracht		1



Q-INFO MOD 8242 / 8243

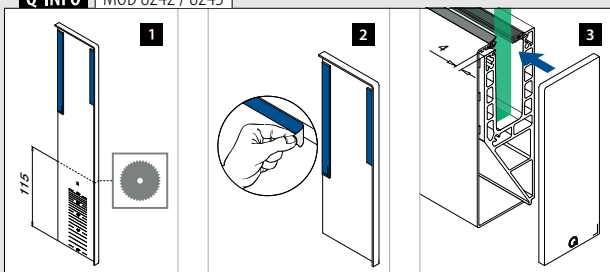

Q-INFO MOD 8243

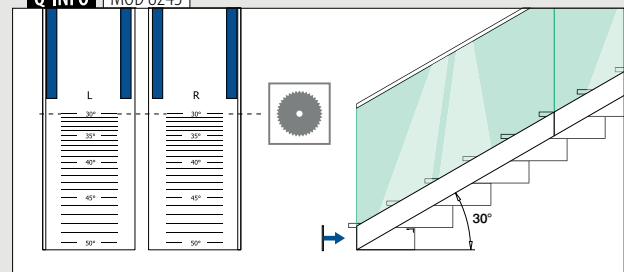

Geländerbasis

Endkappen zur Seitenmontage

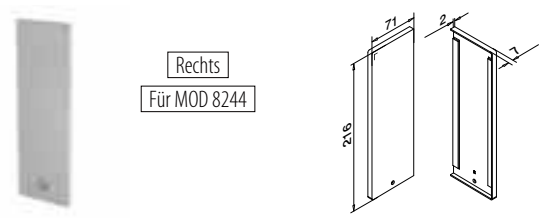
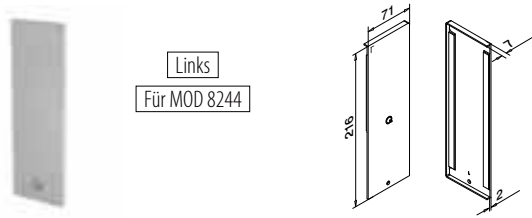

MOD 8242

Aluminium Roh	Klebeband	
168242-41-00	Beigelegt	1
Aluminium Gebürstet		
OUTDOOR		
168242-41-18	Angebracht	1

MOD 8242

Aluminium Roh	Klebeband	
168242-42-00	Beigelegt	1
Aluminium Gebürstet		
OUTDOOR		
168242-42-18	Angebracht	1

NEW

NEW

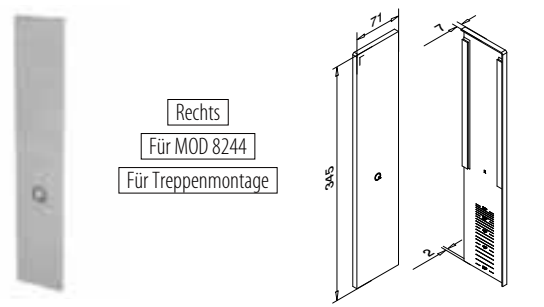
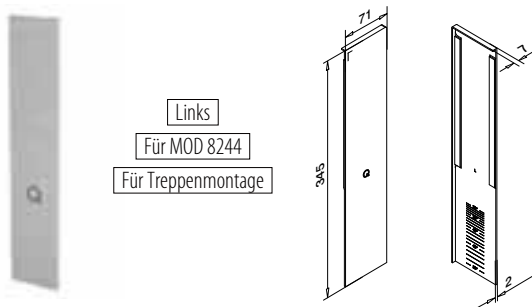

MOD 8243

Aluminium Gebürstet	Klebeband	
168243-41-18	Angebracht	1

MOD 8243

Aluminium Gebürstet	Klebeband	
168243-42-18	Angebracht	1

NEW

NEW

Geländerbasis

Glas-Stopp



MOD 8204

Zubehör		
208204		1

NEW

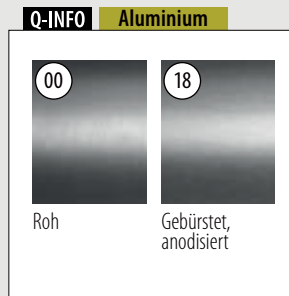
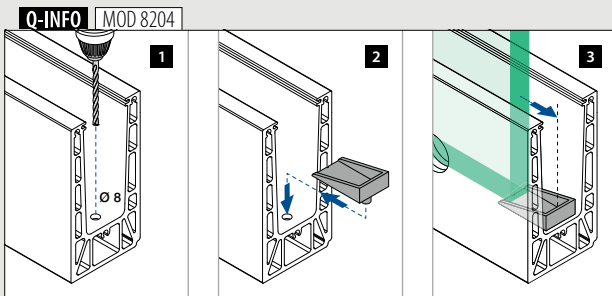

Blendleisten zur Seitenmontage

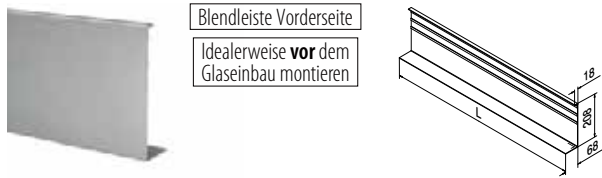

MOD 8245

Aluminium	Roh		
		Klebeband	
SELL OUT	168245-050-00	Nicht inkl.*	L = 5 m
Aluminium	Gebürstet		
		OUTDOOR	
SELL OUT	168245-050-18	Angebracht	L = 5 m



*Bestellen Sie MOD 1360 (Klebeband)

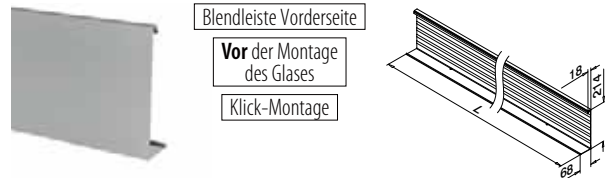

MOD 8244

Aluminium	Roh		
		Klebeband	
	168244-050-00		L = 5 m
Aluminium	Gebürstet		
		OUTDOOR	
	168244-050-18		L = 5 m



Zubehör

Acrylat-Klebeband



MOD 1360

		Zubehör			
	Q	W	L		
	201360	Q-53	9	33 m (für 11 m Blendleiste)	1

Q-INFO MOD 8245-050-00 / 1360

Montage-Informationen:



SELL OUT Nur solange der Vorrat reicht.

Q-INFO MOD 8245

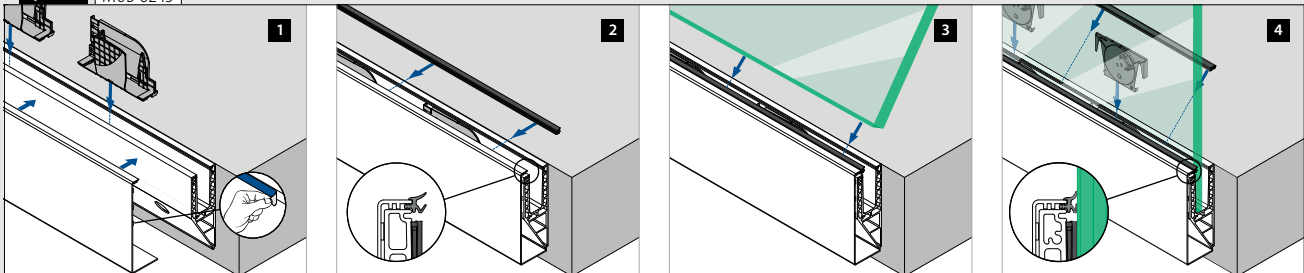

Q-INFO MOD 8244

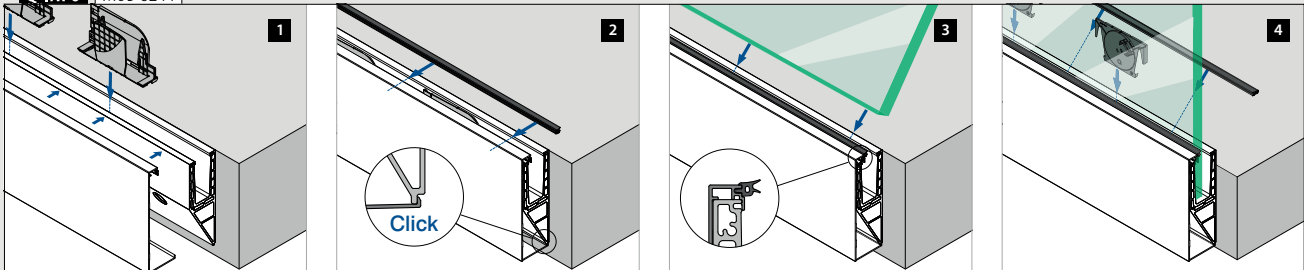

Geländerbasis

Bauanschlussleisten zur Bodenmontage

Für alle Smart-Profile

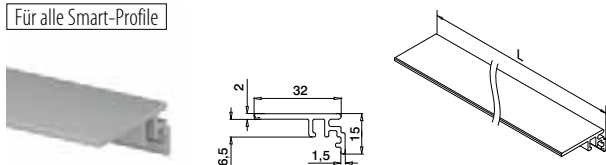

MOD 6973

Aluminium	Roh	
166973-50-00		L = 5 m
Aluminium	Gebürstet	
OUTDOOR		
166973-50-18		L = 5 m

PREFIX

Für Smart **Boden-**
montage- und **F**-Profile

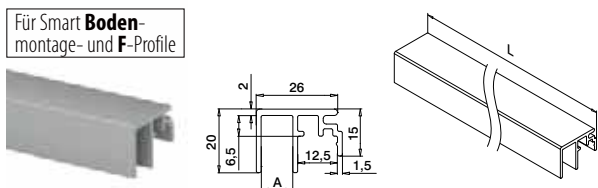

MOD 6972

Aluminium	Roh	
	A	
166972-010-50-00	10	L = 5 m
Aluminium	Gebürstet	
OUTDOOR		
166972-010-50-18	10	L = 5 m

PREFIX

Für alle Smart-Profile

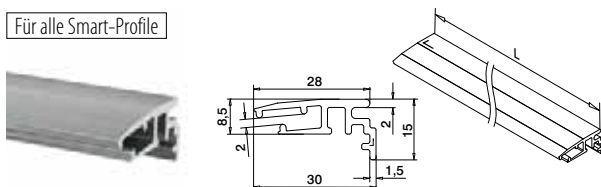

MOD 6979

Aluminium	Roh	
166979-002-50-00		L = 5 m
Aluminium	Gebürstet	
OUTDOOR		
166979-002-50-18		L = 5 m

NEW

PREFIX

Für Smart **Boden-**
montage- und **F**-Profile

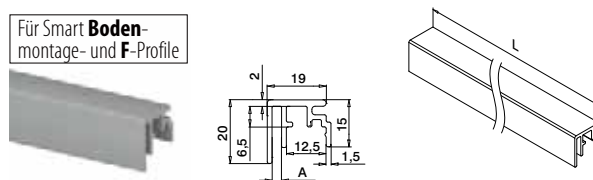

MOD 6972

Aluminium	Roh	
	A	
166972-003-50-00	3	L = 5 m
Aluminium	Gebürstet	
OUTDOOR		
166972-003-50-18	3	L = 5 m

PREFIX

Für Smart **Boden-**
montage- und **F**-Profile

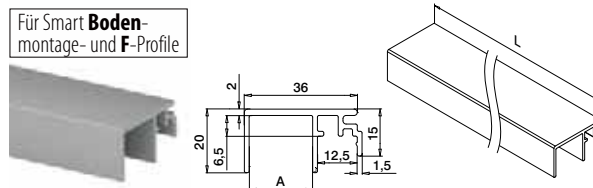

MOD 6972

Aluminium	Roh	
	A	
166972-020-50-00	20	L = 5 m
Aluminium	Gebürstet	
OUTDOOR		
166972-020-50-18	20	L = 5 m

PREFIX

Geländerbasis

Bauanschlussleisten-/Trenngummi

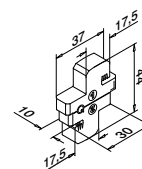

MOD 8205

Zubehör	
208205-010	5



Q-INFO Aluminium

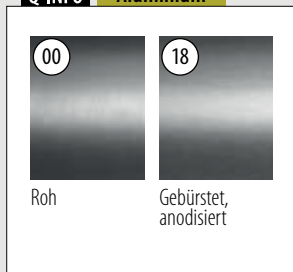

Q-INFO

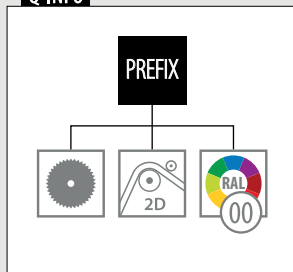

Q-INFO MOD 8205

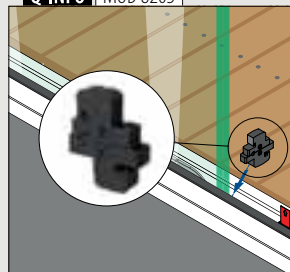

Bauanschlussleisten zur Seitenmontage

Für alle Smart-Profile

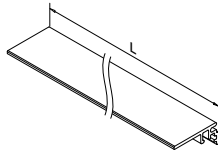
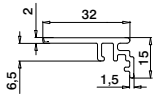

MOD 6973

Aluminium	Roh		
166973-50-00		L = 5 m	
Aluminium	Gebürstet		
OUTDOOR			
166973-50-18		L = 5 m	

PREFIX

Für Smart **Seiten-**
montage- und **Y-**Profile

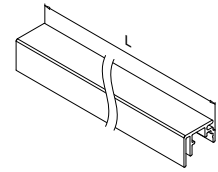
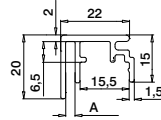

MOD 6970

Aluminium	Roh	A	
166970-003-50-00		3	L = 5 m
Aluminium	Gebürstet		
OUTDOOR			
166970-003-50-18		3	L = 5 m

PREFIX

Für Smart **Seiten-**
montage- und **Y-**Profile

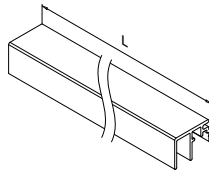
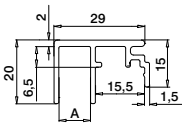

MOD 6970

Aluminium	Roh	A	
166970-010-50-00		10	L = 5 m
Aluminium	Gebürstet		
OUTDOOR			
166970-010-50-18		10	L = 5 m

PREFIX

Für Smart **Seiten-**
montage- und **Y-**Profile

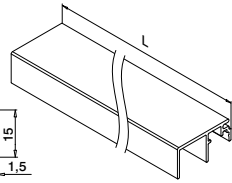
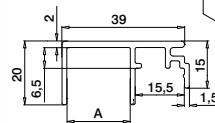

MOD 6970

Aluminium	Roh	A	
166970-020-50-00		20	L = 5 m
Aluminium	Gebürstet		
OUTDOOR			
166970-020-50-18		20	L = 5 m

PREFIX

Q-INFO MOD 6979

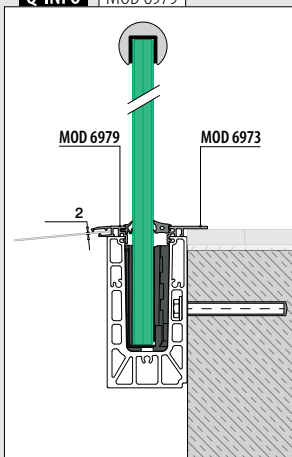

Q-INFO MOD 6972-010 / 6973

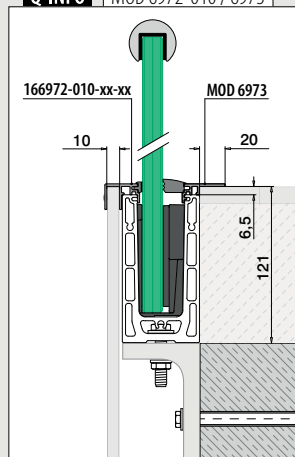

Q-INFO MOD 6972-020 / 6973

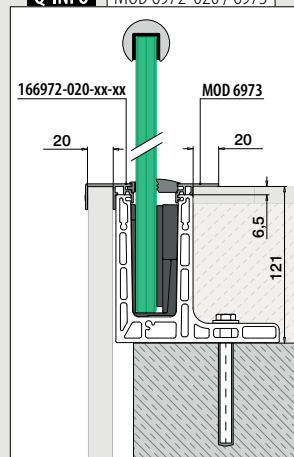

Q-INFO MOD 6970-010 / 6973

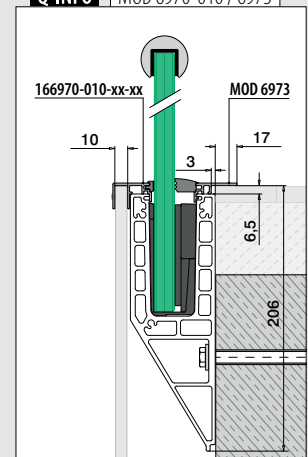



Beanspruchung: Leicht und mittel
Verwendung: Innen- und Aussenbereich
Montage: Boden-, In-Boden- und Seitenmontage
Anwendung: Balkone, Galerien, Wege, Abtrennungen, Treppen und französische Balkone
Material: Aluminium (gebürstet anodisiert und roh)
Glasstärke: 16,76 bis 21,52 mm

Finden Sie alle Informationen zu Easy Glass Smart+ online:



<https://q-ne.ws/SmartPlus23>

EASY GLASS® SMART+



red dot winner 2020
innovative product

Installieren und justieren Sie auch 16,76 - 21,52 mm starkes Glas schnell und einfach

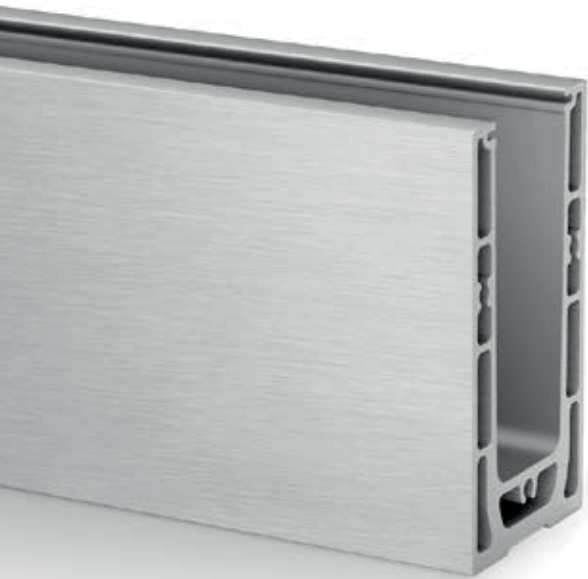

Suchen Sie nach einer Lösung, um Glas bis zu 21,52 mm einfach zu montieren – und darüber hinaus die einzelnen Glasscheiben präzise auszurichten? Dann kommt mit Easy Glass® Smart+ nun die Antwort. Ähnlich wie beim Schwestersystem Easy Glass® Smart müssen Sie bei Smart+ nur die Bodenprofile montieren, das Glas einsetzen und fixieren. Mithilfe des justierbaren Q-disc® Systems können Sie die Glasfüllung zudem auch in der Vertikalen ausrichten.

Easy Glass® Smart+

Max. Holmlast (kN/m)

CH

1.6



Bitte beachten Sie die Spezifikationen wie Befestigungs- und Glasmasse sowie Glastypeen der jeweiligen Zertifikate.

International getestet/berechnet/zertifiziert:



- 1 Mit dem justierbaren Q-disc System können Sie die Glasfüllung nicht nur fixieren, sondern auch um 0,6° in der Vertikalen ausrichten.
- 2 Die Q-disc gibt Ihnen direktes Feedback dank des Klickgeräusches während der Montage.
- 3 Speziell entwickelt für laminiertes Glas mit einer Stärke von 16,76 oder 21,52 mm.

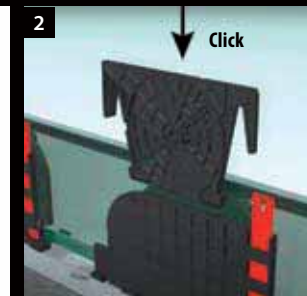
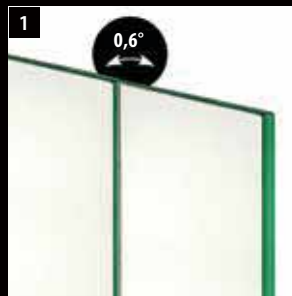

EASY GLASS® SMART+ MONTAGEOPTIONEN

Smart+

Bodenmontage

- Auch für die In-Bodenmontage

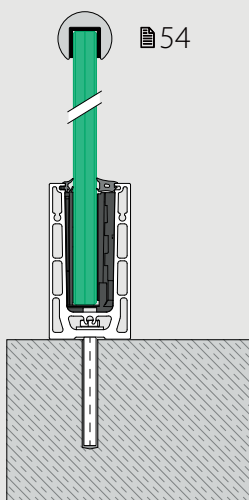

Smart+

Seitenmontage

- Auch zur Montage an der Innenseite von Aufmauerungen
- Bodenprofil-Blendleiste erhältlich

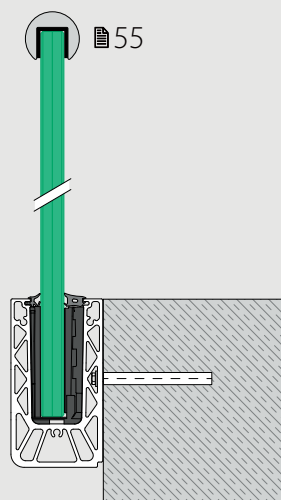

COMING SOON

F und Y Bodenprofile

Smart+ F

Bodenmontage

- Für Rohfußböden
- Kann direkt an oder über der Bodenkante angebracht werden

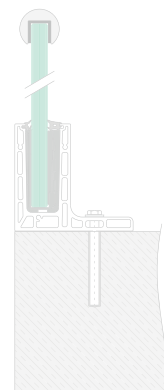

Smart+ Y

Seitenmontage

- Für Rohfußböden
- Kann direkt an oder über der Bodenkante angebracht werden

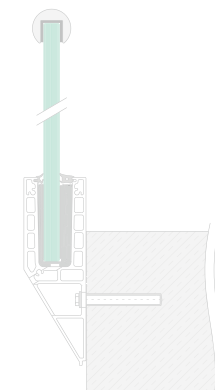



JUSTIERBARES Q-DISC® SYSTEM SCHIEBEN UND AUSRICHTEN!



SO FUNKTIONIERT'S

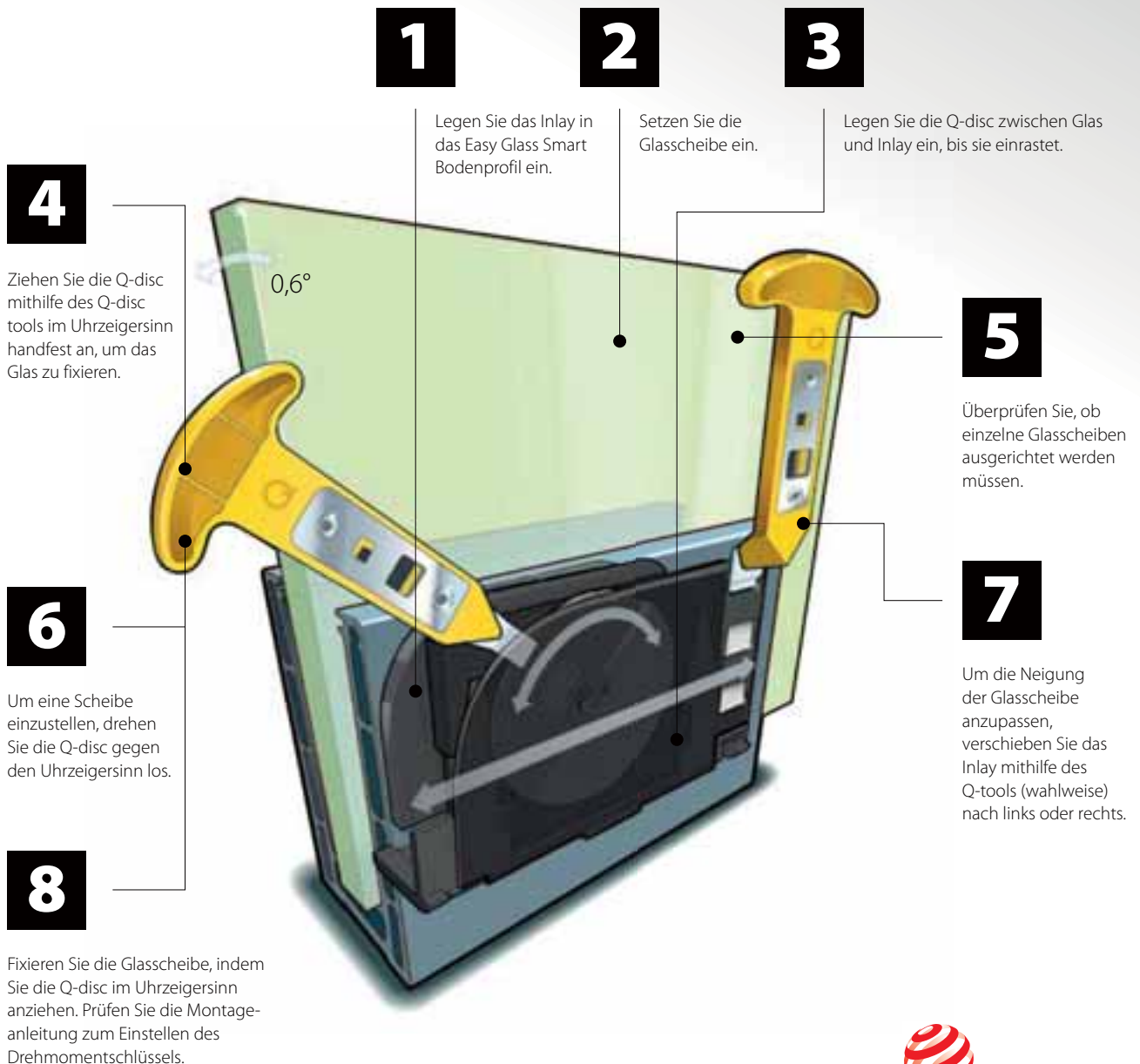

reddot winner 2020
innovative product

Q-disc® System (Gummi, Inlay und Q-disc®)

Glasklemmung und -justierung

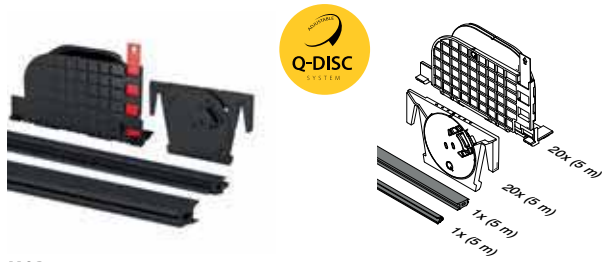

MOD 8301

Zubehör

Für laminiertes Glas	T	
208301-050-17	16,76	L = 5 m
208301-050-18	17,52	L = 5 m
208301-050-22	21,52	L = 5 m
208301-250-17	16,76	L = 25 m
208301-250-18	17,52	L = 25 m
208301-250-22	21,52	L = 25 m



Internationaler Geschmacksmusterschutz

Zubehör

Q-disc®- und Inlay-Werkzeug



MOD 1000

Zubehör

	Q	
201000	Q-84	1

Zubehör

Einzelne Gummis



MOD 8207

Zubehör

208207-250-00	L = 25 m
---------------	----------

NEW



MOD 8207

Zubehör

Für laminiertes Glas	T	
208207-250-14	16,76 - 17,52	L = 25 m
208207-250-18	21,52	L = 25 m

NEW

Zubehör

Q-disc®-Sets

Glasklemmung und -justierung



MOD 8309

Zubehör

Für laminiertes Glas	T	
208309-17	16,76	5
208309-18	17,52	5
208309-22	21,52	5



Q-INFO MOD 1000

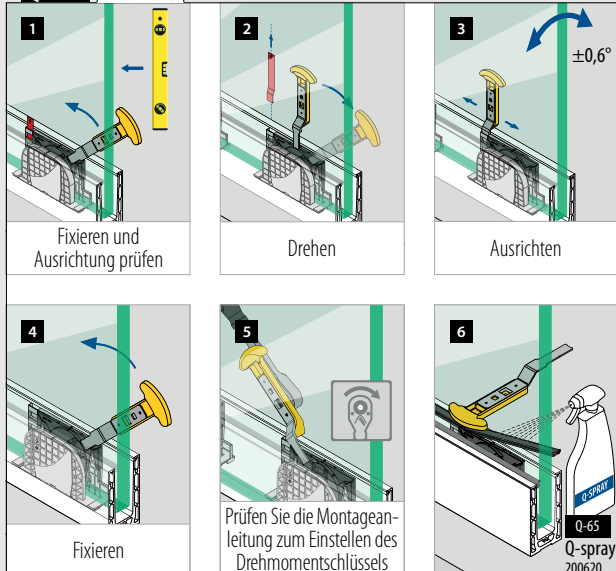

Q-INFO

Installationsblech

MOD 1002

480



Geländerbasis

Bodenprofile zur Bodenmontage

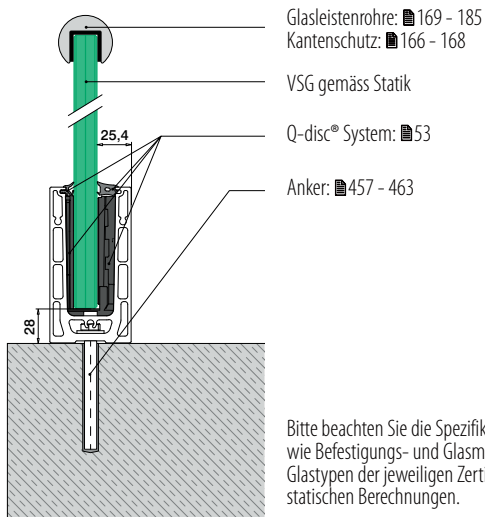

Bitte beachten Sie die Spezifikationen wie Befestigungs- und Glasmasse sowie Glastypen der jeweiligen Zertifikate und statischen Berechnungen.

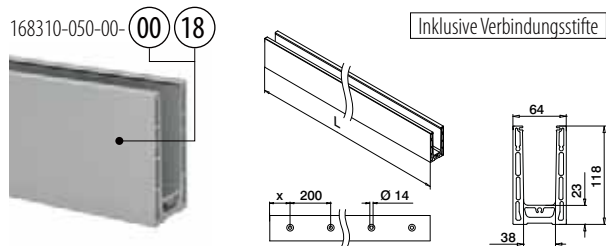

MOD 8310

Aluminium Roh	X		
168310-050-00-00	100	457 - 463	L = 5 m
Aluminium Gebürstet			
OUTDOOR			
168310-025-00-18	50	457 - 463	L = 2,5 m
168310-050-00-18	100	457 - 463	L = 5 m



Internationaler Geschmacksmusterschutz

Geländerbasis

Ecken zur Bodenmontage

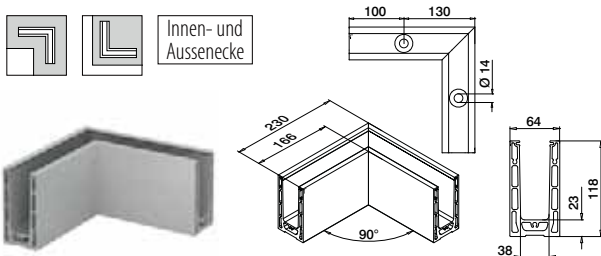

MOD 8311

Aluminium Roh		
168311-00-00	457 - 463	1
Aluminium Gebürstet		
OUTDOOR		
168311-00-18	457 - 463	1



Internationaler Geschmacksmusterschutz

Geländerbasis

Endkappen zur Bodenmontage



MOD 8312

Aluminium Roh	Klebeband	
168312-00-00	Beigelegt	1
Aluminium Gebürstet		
OUTDOOR		
168312-00-18	Angebracht	1



Q-INFO MOD 8310

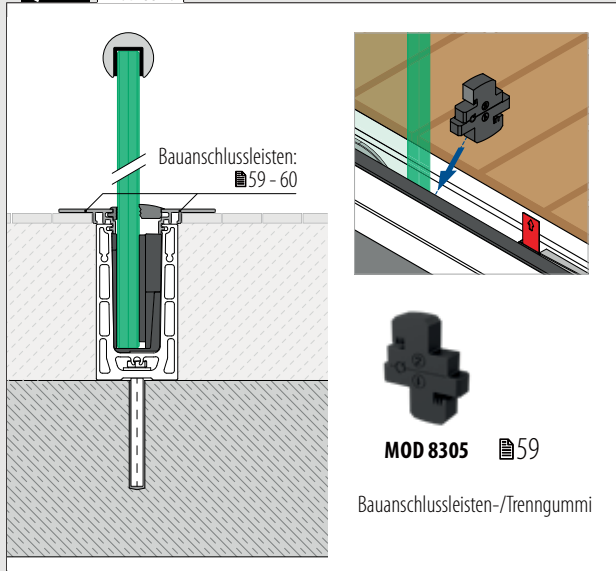

Q-INFO MOD 8310

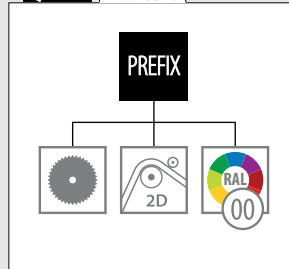

Q-INFO MOD 8310 / 8311



Q-INFO MOD 8312

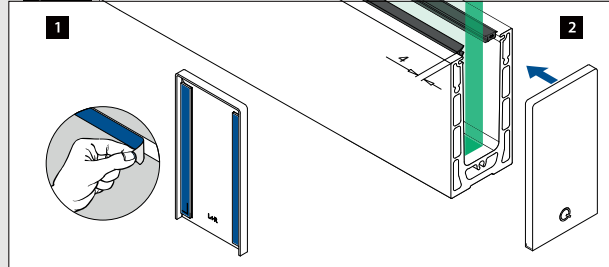

Bodenprofile zur Seitenmontage

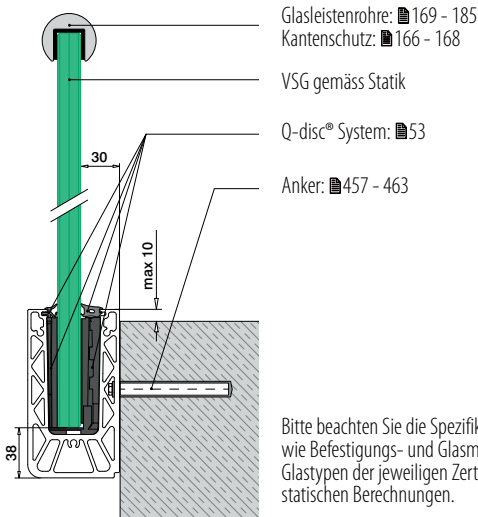

Bitte beachten Sie die Spezifikationen wie Befestigungs- und Glasmasse sowie Glastypen der jeweiligen Zertifikate und statischen Berechnungen.

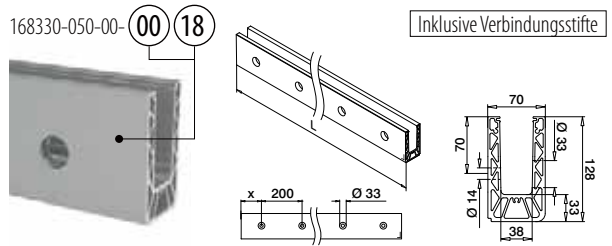

MOD 8330

Aluminium	Roh	X		
168330-050-00-00	100	■ 457 - 463		L = 5 m
Aluminium	Gebürstet	OUTDOOR		
168330-025-00-18	50	■ 457 - 463		L = 2,5 m
168330-050-00-18	100	■ 457 - 463		L = 5 m



Internationaler Geschmacksmusterschutz

Ecken zur Seitenmontage

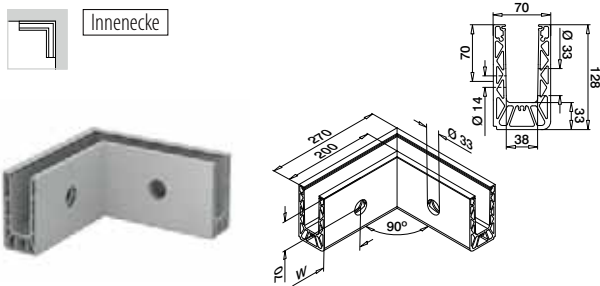

MOD 8331

Aluminium	Roh	W		
168331-01-00	100*	■ 457 - 463		1
Aluminium	Gebürstet	OUTDOOR		
168331-01-18	100*	■ 457 - 463		1

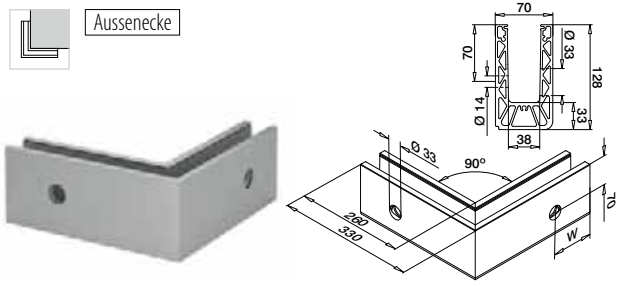

MOD 8331

Aluminium	Roh	W		
168331-02-00	100*	■ 457 - 463		1
Aluminium	Gebürstet	OUTDOOR		
168331-02-18	100*	■ 457 - 463		1



*Die Lochposition kann produktionsbedingt abweichen.

Q-INFO MOD 8330

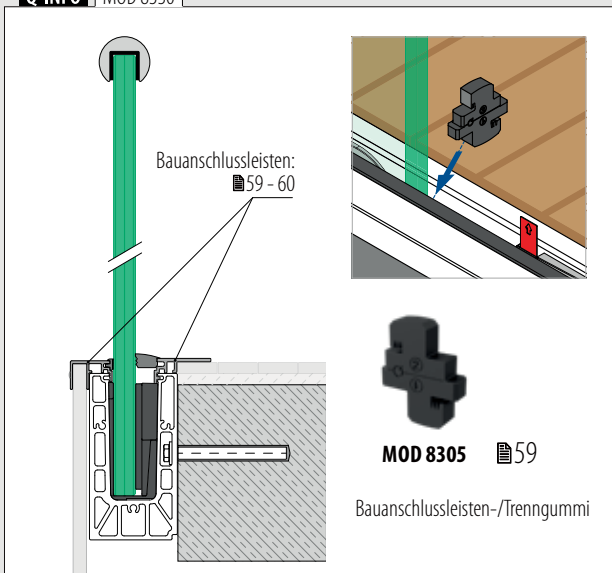

Q-INFO MOD 8330

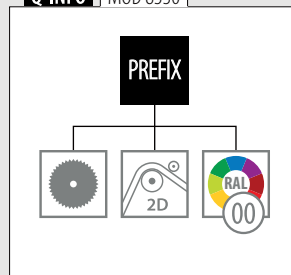

Q-INFO Aluminium



Q-INFO



Geländerbasis

Endkappen zur Seitenmontage

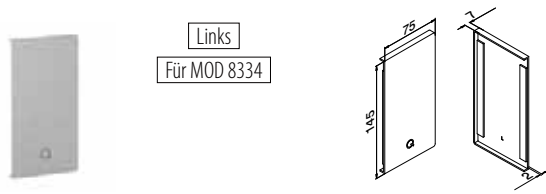

Links
Für MOD 8334

MOD 8332

Aluminium	Roh		
	Klebeband		
168332-41-00	Beigelegt	1	
Aluminium	Gebürstet		
OUTDOOR			
168332-41-18	Angebracht	1	

NEW

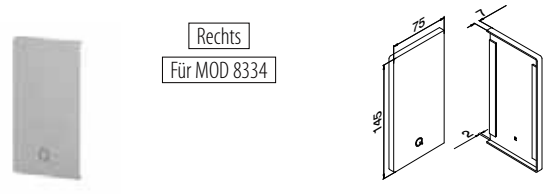

Rechts
Für MOD 8334

MOD 8332

Aluminium	Roh		
	Klebeband		
168332-42-00	Beigelegt	1	
Aluminium	Gebürstet		
OUTDOOR			
168332-42-18	Angebracht	1	

NEW

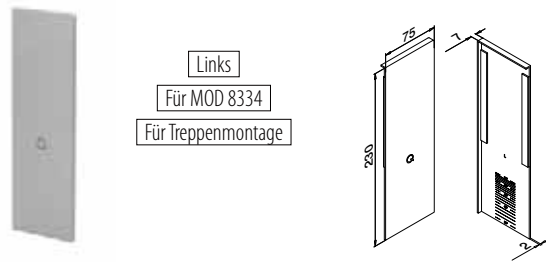

Links
Für MOD 8334
Für Treppenmontage

MOD 8333

Aluminium	Gebürstet		
OUTDOOR	Klebeband		
168333-41-18	Angebracht	1	

NEW

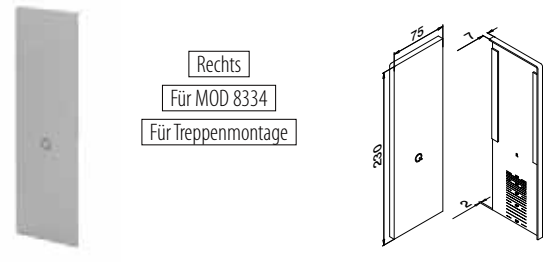

Rechts
Für MOD 8334
Für Treppenmontage

MOD 8333

Aluminium	Gebürstet		
OUTDOOR	Klebeband		
168333-42-18	Angebracht	1	

NEW



Geländerbasis

Drainageleisten zur Seitenmontage

4 Stück für 2,5-Meter-Bodenprofil
8 Stück für 5-Meter-Bodenprofil

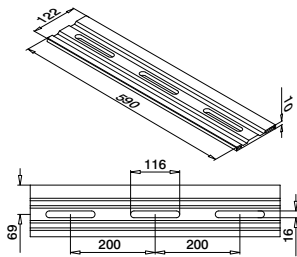

MOD 8337

Aluminium	Gebürstet		
OUTDOOR	Klebeband		
168337-18	Angebracht	4	

NEW

Geländerbasis

Unterlegscheiben zur Seitenmontage

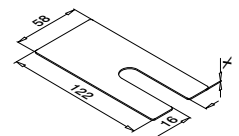

MOD 8336

Aluminium	Roh		
	X		
168336-001	1	100	
168336-002	2	100	
168336-003	3	100	

NEW

Q-INFO MOD 8337

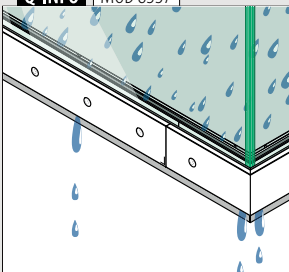

Montage-
informationen:



<https://q-ne.ws/SmartPlus23>

Q-INFO MOD 8336

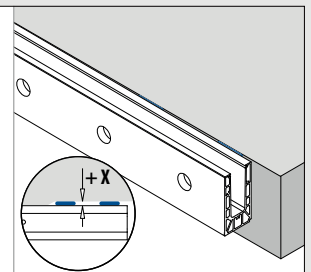
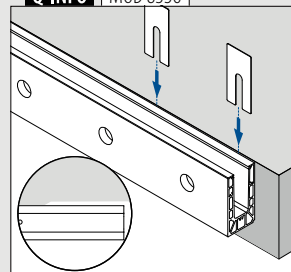

Blendleisten zur Seitenmontage

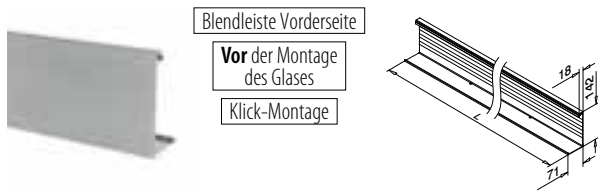

MOD 8334

Aluminium	Roh	
168334-050-00		L = 5 m
Aluminium	Gebürstet	
OUTDOOR		
168334-050-18		L = 5 m

NEW

Blendstopfen zur Seitenmontage

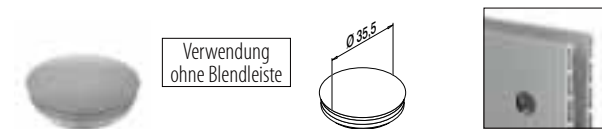

MOD 8238

Kunststoff	Aluminium RAL 9006	
INDOOR		10
158238-36		

Glas-Stopp



MOD 8304

Zubehör	
208304	1

NEW

Q-INFO Aluminium

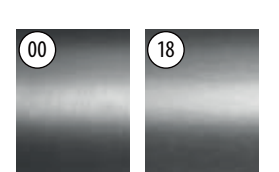

Q-INFO MOD 8334

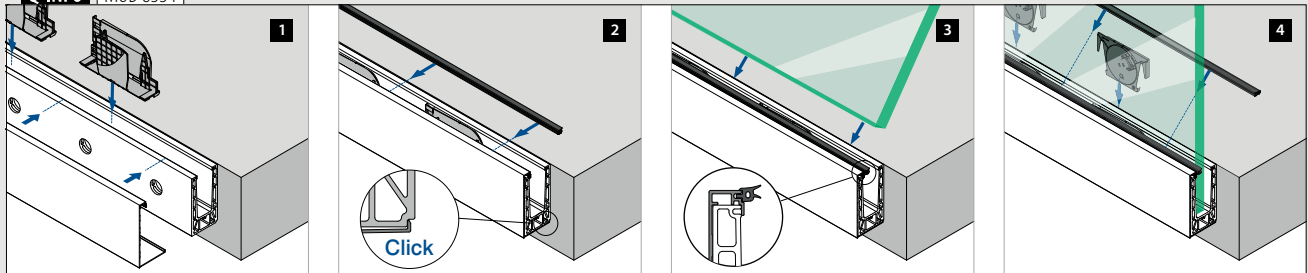

Q-INFO MOD 8238

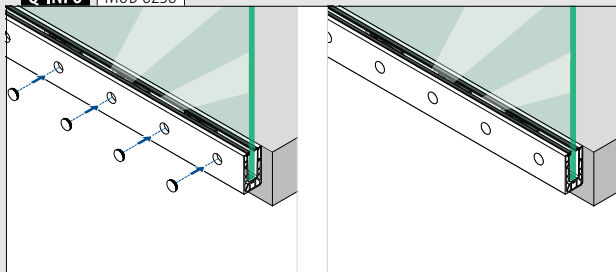

Q-INFO MOD 8304

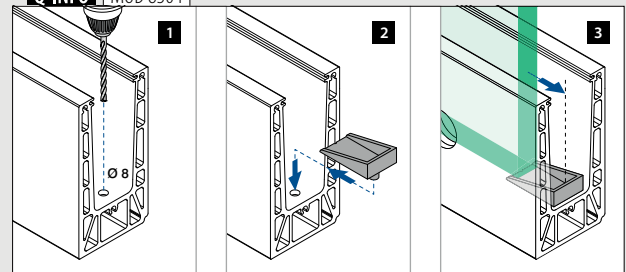

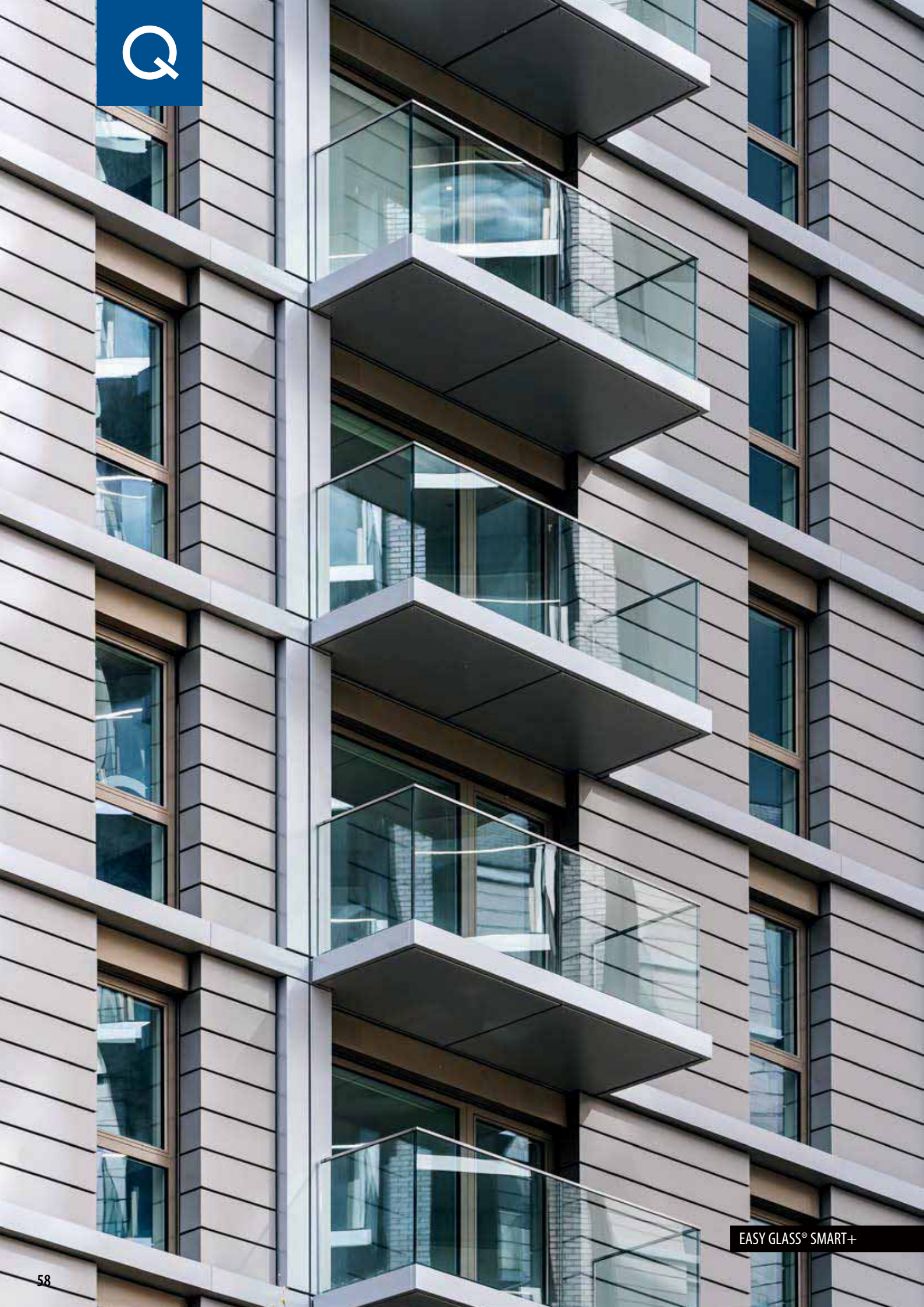

EASY GLASS® SMART+

Bauanschlussleisten

Für alle Smart+-Profile

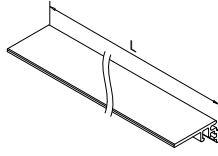
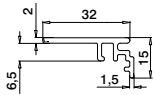

MOD 6973

Aluminium	Roh	
166973-50-00	L = 5 m	
Aluminium	Gebürstet	
OUTDOOR		
166973-50-18	L = 5 m	

PREFIX

Für Smart+ Bodenmontage

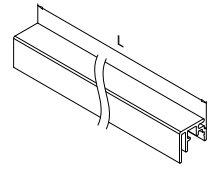
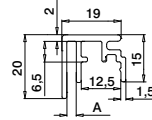

MOD 6972

Aluminium	Roh	
	A	
166972-003-50-00	3	L = 5 m
Aluminium	Gebürstet	
OUTDOOR		
166972-003-50-18	3	L = 5 m

PREFIX

Für Smart+ Bodenmontage

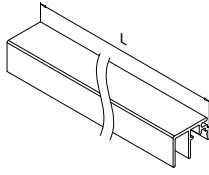
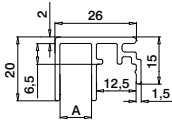

MOD 6972

Aluminium	Roh	
	A	
166972-010-50-00	10	L = 5 m
Aluminium	Gebürstet	
OUTDOOR		
166972-010-50-18	10	L = 5 m

PREFIX

Für Smart+ Bodenmontage

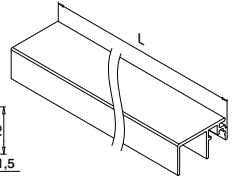
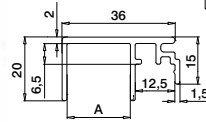

MOD 6972

Aluminium	Roh	
	A	
166972-020-50-00	20	L = 5 m
Aluminium	Gebürstet	
OUTDOOR		
166972-020-50-18	20	L = 5 m

PREFIX

Für alle Smart+-Profile

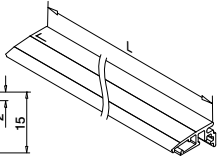
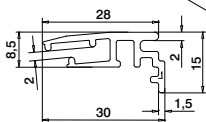

MOD 6979

Aluminium	Roh	
166979-002-50-00	L = 5 m	
Aluminium	Gebürstet	
OUTDOOR		
166979-002-50-18	L = 5 m	

NEW

PREFIX

Geländerbasis

Bauanschlussleisten-/Trenngummi

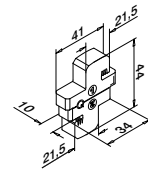

MOD 8305

Zubehör	
208305-010	5

NEW

PREFIX

Q-INFO MOD 6979

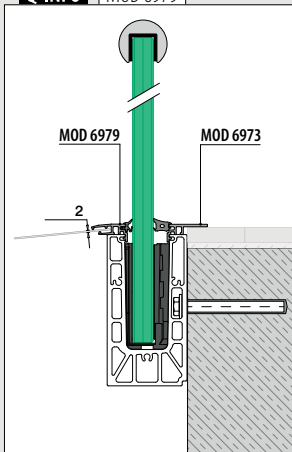

Q-INFO MOD 6972-010 / 6973

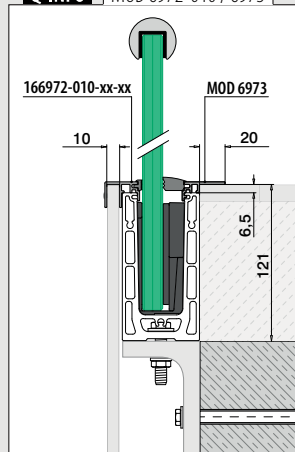

Q-INFO MOD 8305

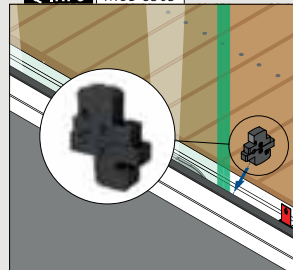

Bauanschlussleisten

Für alle Smart+-Profile

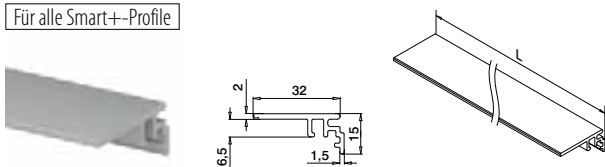

MOD 6973

Aluminium	Roh	
166973-50-00		L = 5 m
Aluminium	Gebürstet	
OUTDOOR		
166973-50-18		L = 5 m

PREFIX

Für Smart+ Seitenmontage

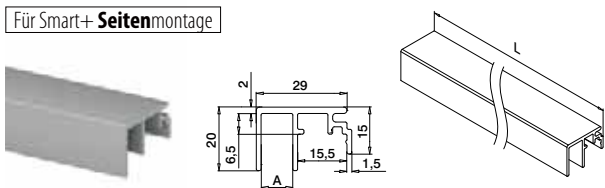

MOD 6970

Aluminium	Roh	
	A	
166970-010-50-00	10	L = 5 m
Aluminium	Gebürstet	
OUTDOOR		
166970-010-50-18	10	L = 5 m

PREFIX

Für Smart+ Seitenmontage

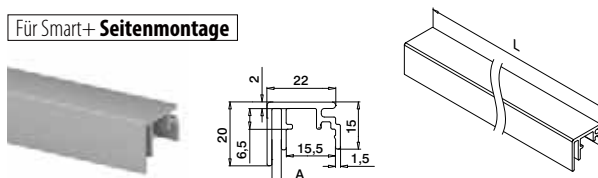

MOD 6970

Aluminium	Roh	
	A	
166970-003-50-00	3	L = 5 m
Aluminium	Gebürstet	
OUTDOOR		
166970-003-50-18	3	L = 5 m

PREFIX

Für Smart+ Seitenmontage

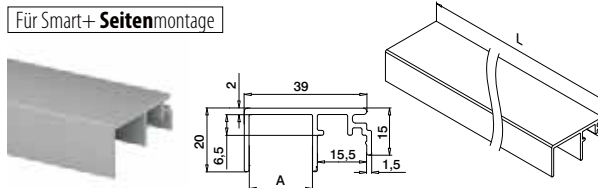

MOD 6970

Aluminium	Roh	
	A	
166970-020-50-00	20	L = 5 m
Aluminium	Gebürstet	
OUTDOOR		
166970-020-50-18	20	L = 5 m

PREFIX

Q-INFO

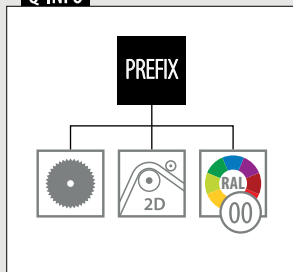

Q-INFO Aluminium

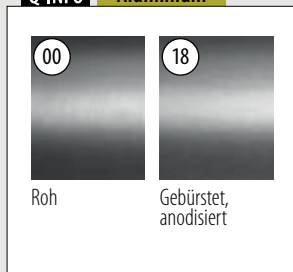

EASY GLASS® SMART+ **HIGH F + Y** BODENPROFILE

COMING SOON

EASY GLASS® SMART+ **HIGH Y**

Seitenmontage

- Für hohe Bodenaufbauten bis zu 180 mm, Gesamthöhe des Profils: 305 mm
- Keine Konsole oder Unterkonstruktion notwendig
- Variable Höhe: Bodenaufbauten zwischen 160 und 180 mm möglich
- Verkleidung für die gesamte Höhe des Profils, für ein einheitliches Aussehen
- Kompatibel mit den Bauanschlussleisten und weiteren Zubehörartikeln der Easy Glass Smart+ Serie
- Speziell für die Treppenmontage entwickelt; keine Verlängerung mit Flachstahl oder ähnlichem notwendig

EASY GLASS® SMART+ **HIGH F**

Bodenmontage

- Für hohe Bodenaufbauten bis zu 180 mm
- Keine Konsole oder Unterkonstruktion notwendig
- Für innen und aussen
- Perfekte Montagefläche, Verkleidungen können nachträglich angebracht werden
- Kompatibel mit den Bauanschlussleisten und weiteren Zubehörartikeln der Easy Glass Smart+ Serie



Beanspruchung: Leicht bis hoch
Verwendung: Innen- und Aussenbereich
Montage: Boden- und Seitenmontage
Anwendung: Balkone, Galerien, Wege, Abtrennungen, Treppen und französische Balkone
Material: Aluminium (gebürstet anodisiert, roh und pulverbeschichtet in RAL 9005 schwarz)
Glasstärke: 16,76 bis 25,52 mm

Finden Sie alle Informationen zu Easy Glass Prime online:

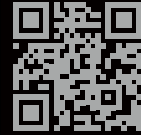

<https://q-ne.ws/Prime23>

EASY GLASS® PRIME



red dot winner 2020
innovative product

Der Turbo für Ihre Projekte



Wenn Sie auf der Suche nach einem Glasgeländersystem für dickere Glasstärken sind und Sie die Glasscheiben zudem ausrichten möchten, ist Easy Glass® Prime genau das Richtige für Sie. Die Bodenprofile enthalten das verstellbare Q-disc® System, mit dem Sie das Glas durch einfaches Verschieben und Drehen ausrichten und sichern können. Dank der Grösse der Bohrlöcher eignet sich das System auch für die Montage auf unebenen Oberflächen.

Easy Glass® Prime	CH
Max. Holmlast (kN/m)	3,0



Bitte beachten Sie die Spezifikationen wie Befestigungs- und Glasmasse sowie Glastypeen der jeweiligen Zertifikate.

International getestet/berechnet/zertifiziert:



- 1 Richten Sie die Glasscheiben um bis zu 1,2° in der Vertikalen aus.
- 2 Durch Markierungen und ein Klickgeräusch signalisiert die Q-disc die korrekte Installation.
- 3 Geeignet für Glasstärken zwischen 16,76 und 25,52 mm.

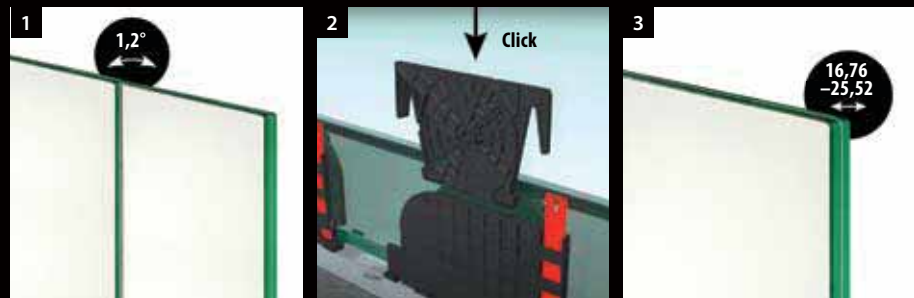

EASY GLASS® PRIME MONTAGEOPTIONEN

Prime

Bodenmontage

- Symmetrisches Bodenprofil

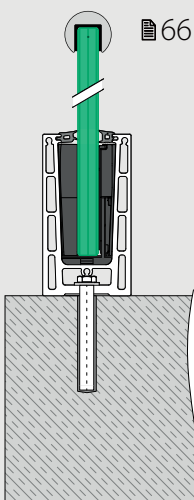

Prime F

Bodenmontage

- Für Rohfussböden
- Kann direkt an oder über der Bodenkante angebracht werden

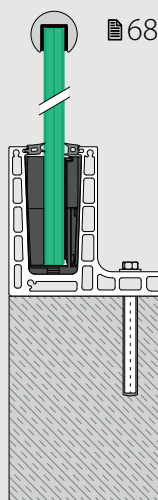

Prime

Seitenmontage

- Auch zur Montage an der Innenseite von Aufmauerungen
- Bodenprofil-Blendeleiste erhältlich

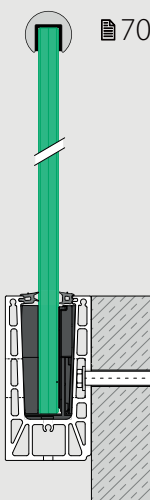

Prime Y

Seitenmontage

- Für Rohfussböden
- Kann direkt an oder über der Bodenkante angebracht werden
- Bodenprofil-Blendeleiste erhältlich

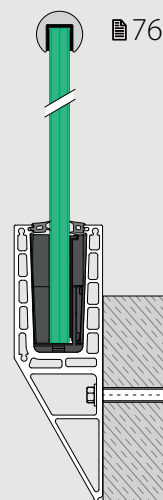



JUSTIERBARES Q-DISC® SYSTEM SCHIEBEN UND AUSRICHTEN!



SO FUNKTIONIERT'S

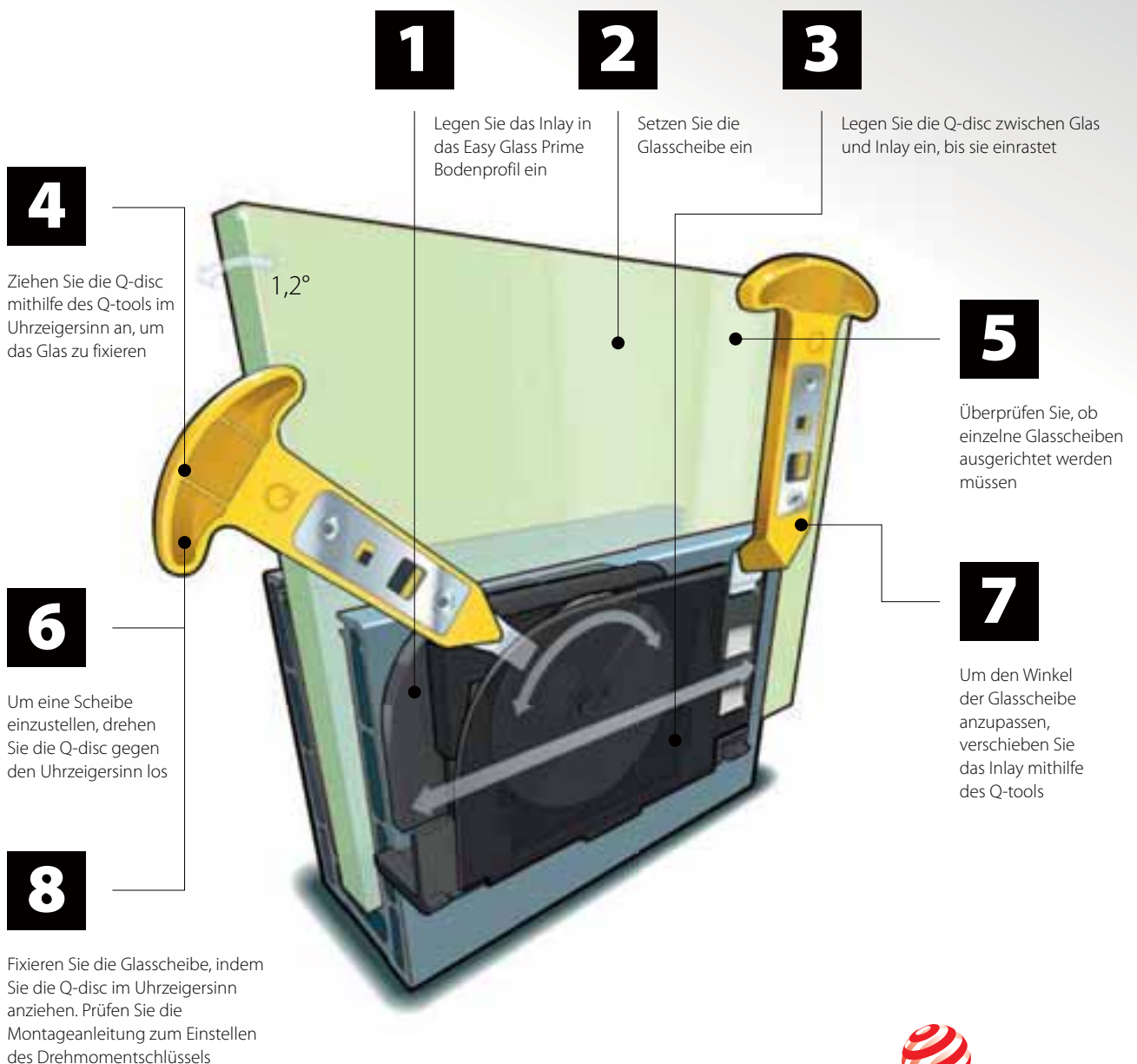

reddot winner 2020
innovative product

Q-disc® System (Gummi, Inlay und Q-disc®)

Glasklemmung und -justierung

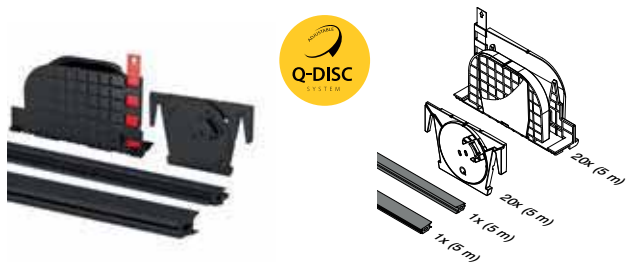

MOD 8401

Zubehör

Für monolithisches Glas	T	
208401-050-19	19	L = 5 m

Für laminiertes Glas

208401-050-17	16,76	L = 5 m
208401-050-18	17,52	L = 5 m
208401-050-21	20,76	L = 5 m
208401-050-22	21,52	L = 5 m
208401-050-24	24,76	L = 5 m
208401-050-26	25,52	L = 5 m
208401-250-17	16,76	L = 25 m
208401-250-18	17,52	L = 25 m
208401-250-21	20,76	L = 25 m
208401-250-22	21,52	L = 25 m
208401-250-24	24,76	L = 25 m
208401-250-26	25,52	L = 25 m



Internationaler Geschmacksmusterschutz

Zubehör

Q-disc®- und Inlay-Werkzeug



MOD 1000

Zubehör

	Q	
201000	Q-84	1

Q-INFO MOD 1000

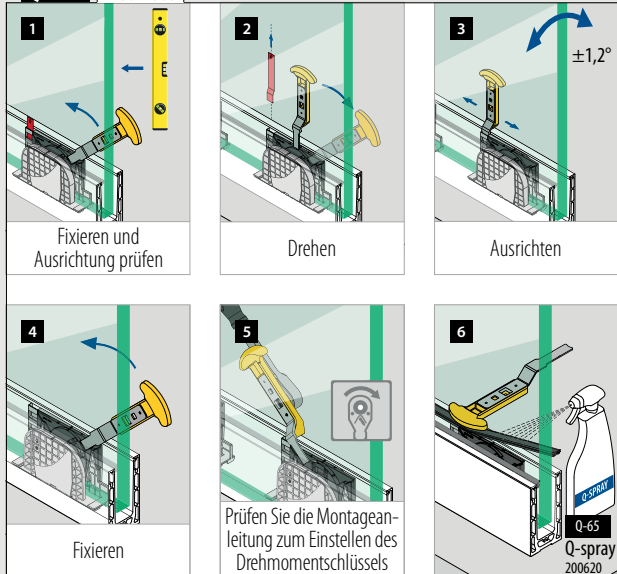

Einzelne Gummis

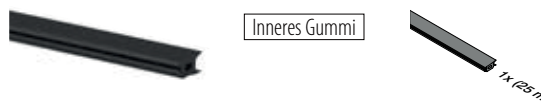

MOD 8407

Zubehör

208407-250-00		L = 25 m
---------------	--	----------



MOD 8407

Zubehör

Für monolithisches Glas	T	
208407-250-19	19	L = 25 m

Für laminiertes Glas

208407-250-17	16,76	L = 25 m
208407-250-18	17,52	L = 25 m
208407-250-21	20,76	L = 25 m
208407-250-22	21,52	L = 25 m
208407-250-24	24,76	L = 25 m
208407-250-26	25,52	L = 25 m



Zubehör

Q-disc®-Sets

Glasklemmung und -justierung



MOD 8409

Zubehör

Für monolithisches Glas	T	
208409-19	19	5

Für laminiertes Glas

208409-17	16,76	5
208409-18	17,52	5
208409-21	20,76	5
208409-22	21,52	5
208409-24	24,76	5
208409-26	25,52	5



Q-INFO

Installationsblech

MOD 1002

480



Geländerbasis

Bodenprofile zur Bodenmontage

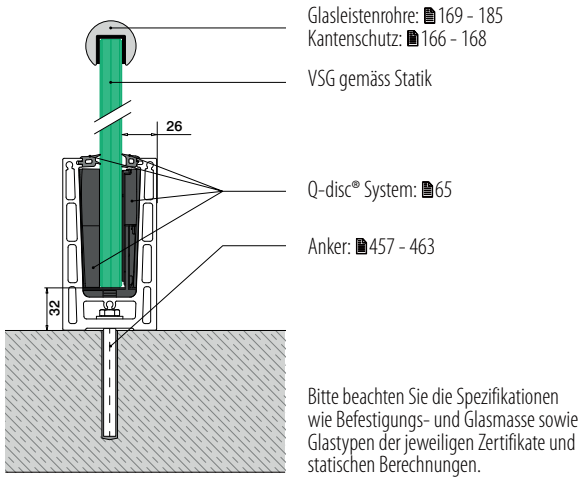

Geländerbasis

Ecken zur Bodenmontage

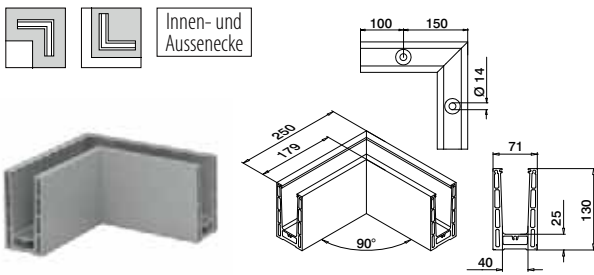

MOD 8411

Aluminium	Roh		
168411-00-00	■ 457 - 463		1
Aluminium	Gebürstet		
OUTDOOR			
168411-00-18	■ 457 - 463		1
Aluminium	Black Line		
OUTDOOR			
NEW 168411-00-82	■ 457 - 463		1

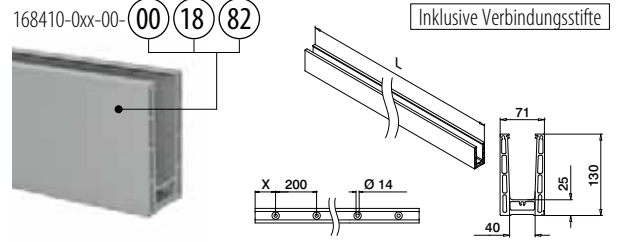

MOD 8410

Aluminium	Roh	X	
168410-050-00-00	100	■ 457 - 463	L = 5 m
Aluminium	Gebürstet		
OUTDOOR			
168410-025-00-18	50	■ 457 - 463	L = 2,5 m
168410-050-00-18	100	■ 457 - 463	L = 5 m
Aluminium	Black Line		
OUTDOOR			
NEW 168410-050-00-82	100	■ 457 - 463	L = 5 m



Internationaler Geschmacksmusterchutz

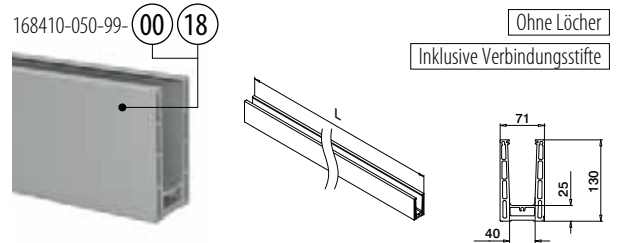

MOD 8410

Aluminium	Roh		
168410-050-99-00			L = 5 m
Aluminium	Gebürstet		
OUTDOOR			
168410-050-99-18			L = 5 m



Internationaler Geschmacksmusterchutz

Q-INFO MOD 8410

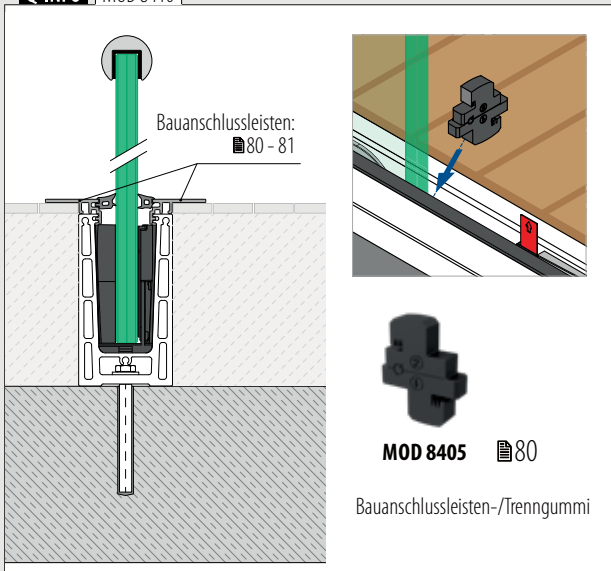

Q-INFO MOD 8410

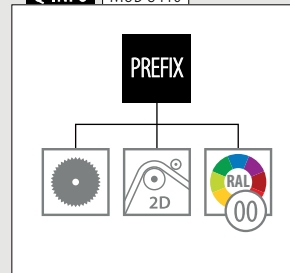

Q-INFO

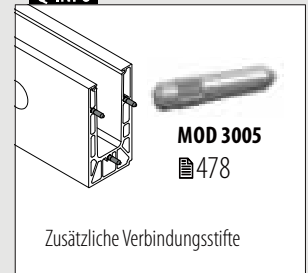

Q-INFO Aluminium



Endkappen zur Bodenmontage

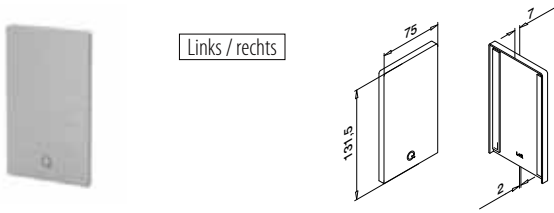

Links / rechts

MOD 8412

Aluminium Roh	Klebeband	
168412-00-00	Beigelegt	1
Aluminium Gebürstet		
OUTDOOR		
168412-00-18	Angebracht	1
Aluminium Black Line		
OUTDOOR		
NEW 168412-00-82	Angebracht	1

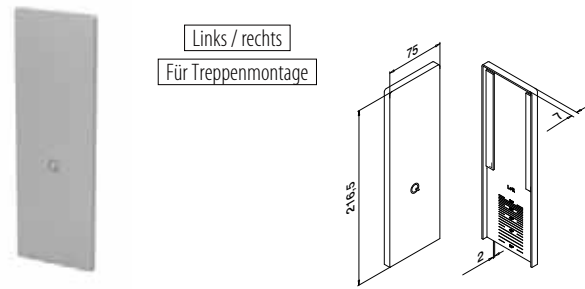

Links / rechts
Für Treppmontage

MOD 8413

Aluminium Roh	Klebeband	
168413-00-00	Beigelegt	1
Aluminium Gebürstet		
OUTDOOR		
168413-00-18	Angebracht	1



Unterlegscheiben zur Bodenmontage

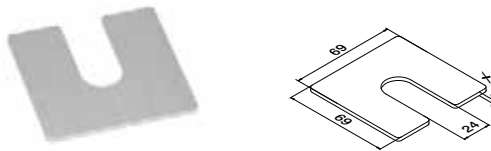

MOD 8416

Aluminium Roh	X	
168416-001	1	100
168416-002	2	100
168416-003	3	100

Drainageleisten zur Bodenmontage

4 Stück für 2,5-Meter-Bodenprofil
8 Stück für 5-Meter-Bodenprofil

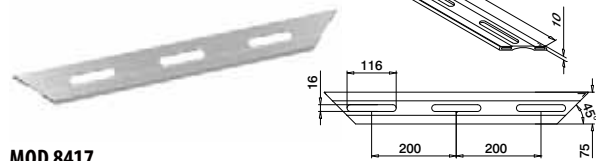

MOD 8417

Aluminium Gebürstet	OUTDOOR	
168417-18		4

Q-INFO MOD 8412

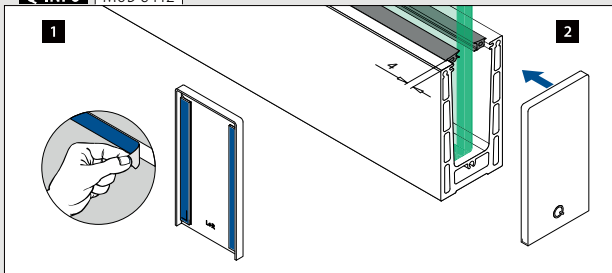

Q-INFO MOD 8416

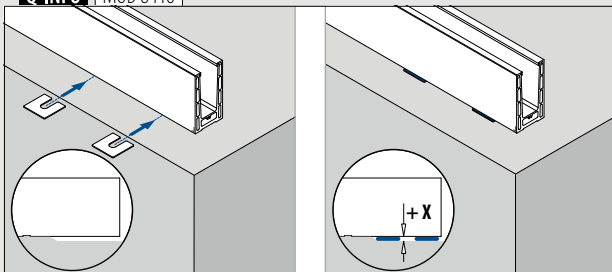

Q-INFO MOD 8413

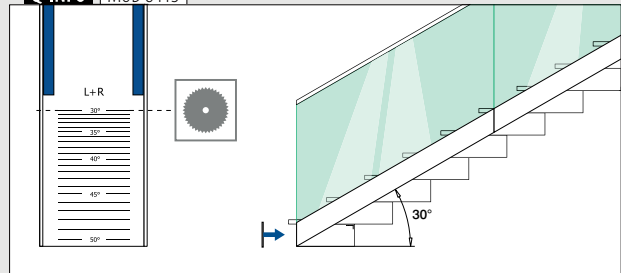

Q-INFO MOD 8417

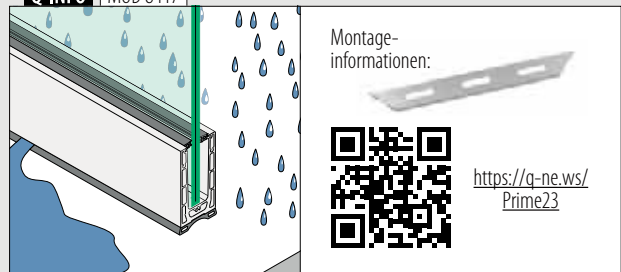

Bodenprofile zur Bodenmontage

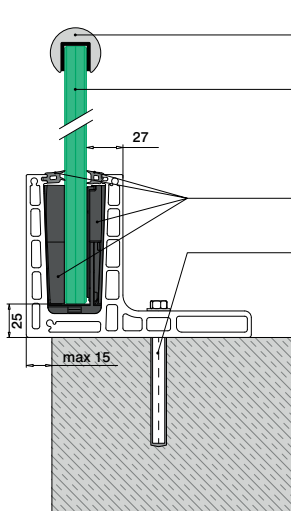

Glasleistenrohre: 169 - 185
 Kantenschutz: 166 - 168
 VSG gemäss Statik
 Q-disc® System: 65
 Anker: 457 - 463

Bitte beachten Sie die Spezifikationen wie Befestigungs- und Glasmasse sowie Glastypen der jeweiligen Zertifikate und statischen Berechnungen.

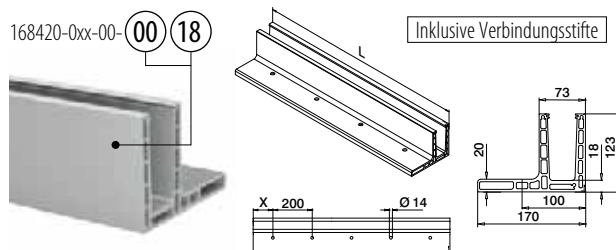

MOD 8420

Aluminium	Roh		
	X		
168420-050-00-00	100	457 - 463	L = 5 m
Aluminium	Gebürstet		
OUTDOOR			
168420-025-00-18	50	457 - 463	L = 2,5 m
168420-050-00-18	100	457 - 463	L = 5 m



Internationaler Geschmacksmusterschutz

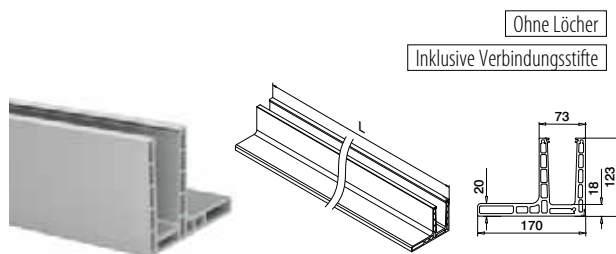

MOD 8420

Aluminium	Gebürstet		
OUTDOOR			
168420-050-99-18			L = 5 m



Internationaler Geschmacksmusterschutz

Q-INFO

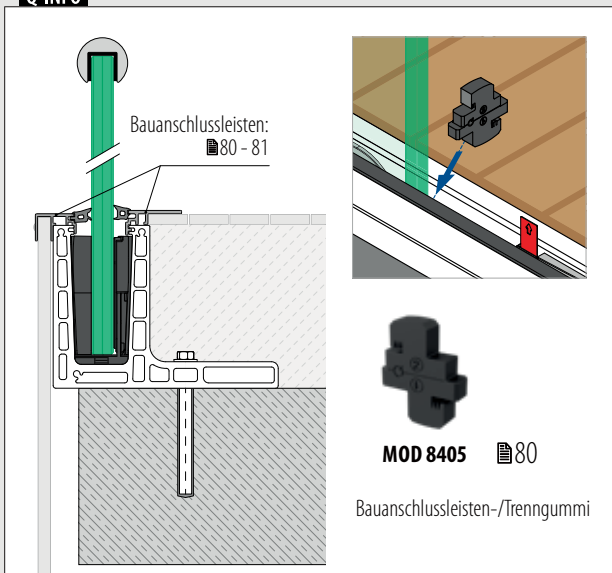

MOD 8405 80
 Bauanschlussleisten-/Trenngummi

Q-INFO

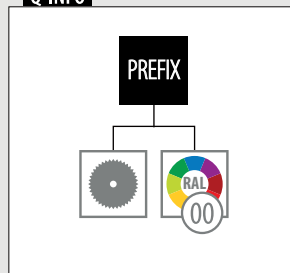

Q-INFO Aluminium



Q-INFO

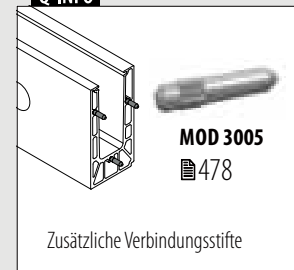

Ecken zur Bodenmontage

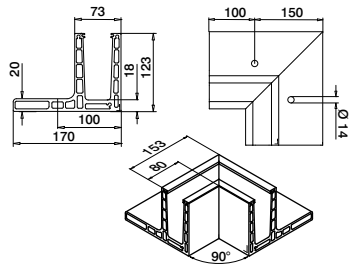
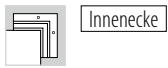

MOD 8421

Aluminium	Gebürstet		
OUTDOOR			
168421-01-18	457 - 463		1

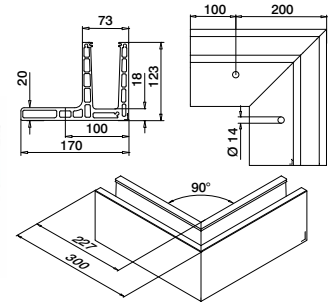

MOD 8421

Aluminium	Gebürstet		
OUTDOOR			
168421-02-18	457 - 463		1



Endkappen zur Bodenmontage



Links

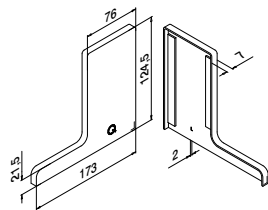

MOD 8422

Aluminium	Roh		
	Kleband		
168422-01-00	Beigelegt		1
Aluminium	Gebürstet		
OUTDOOR			
168422-01-18	Angebracht		1



Rechts

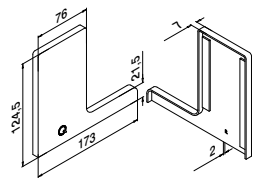

MOD 8422

Aluminium	Roh		
	Kleband		
168422-02-00	Beigelegt		1
Aluminium	Gebürstet		
OUTDOOR			
168422-02-18	Angebracht		1

Q-INFO MOD 8422

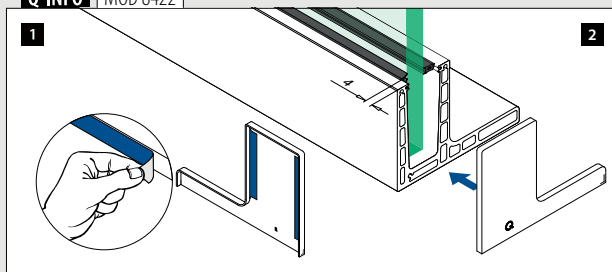

Geländerbasis

Bodenprofile zur Seitenmontage

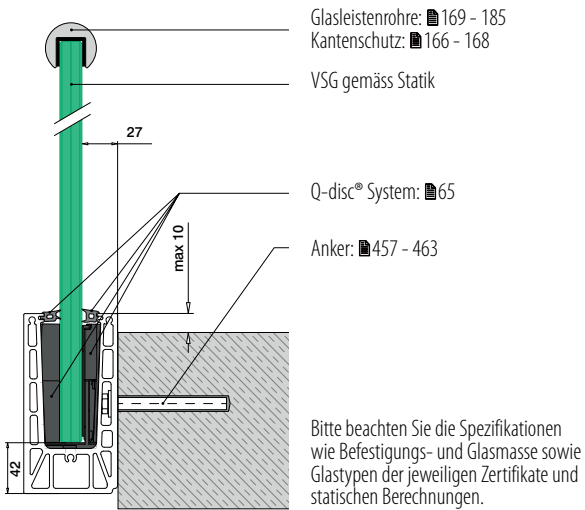

Bitte beachten Sie die Spezifikationen wie Befestigungs- und Glasmasse sowie Glastypen der jeweiligen Zertifikate und statischen Berechnungen.

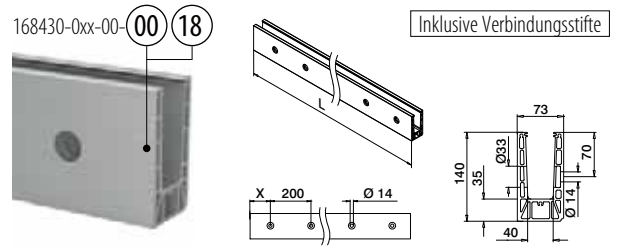

MOD 8430

Aluminium	Roh	X		
168430-050-00-00	100	457 - 463	L = 5 m	
Aluminium	Gebürstet	OUTDOOR		
168430-025-00-18	50	457 - 463	L = 2,5 m	
168430-050-00-18	100	457 - 463	L = 5 m	



Internationaler Geschmacksmusterschutz

Geländerbasis

Ecken zur Seitenmontage

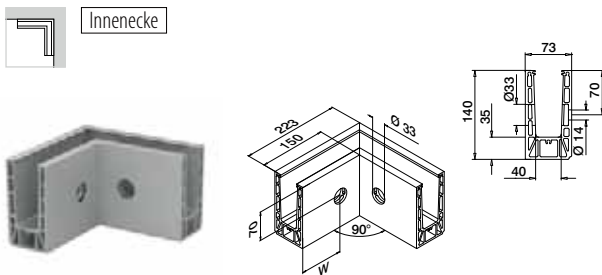

MOD 8431

Aluminium	Roh	W		
168431-01-00	100*	457 - 463	1	
Aluminium	Gebürstet	OUTDOOR		
168431-01-18	100*	457 - 463	1	

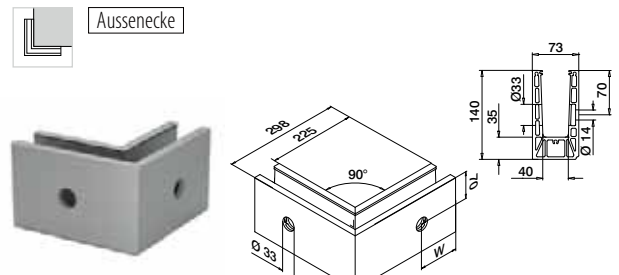

MOD 8431

Aluminium	Roh	W		
168431-02-00	100*	457 - 463	1	
Aluminium	Gebürstet	OUTDOOR		
168431-02-18	100*	457 - 463	1	



*Die Lochposition kann produktionsbedingt abweichen.

Q-INFO MOD 8430

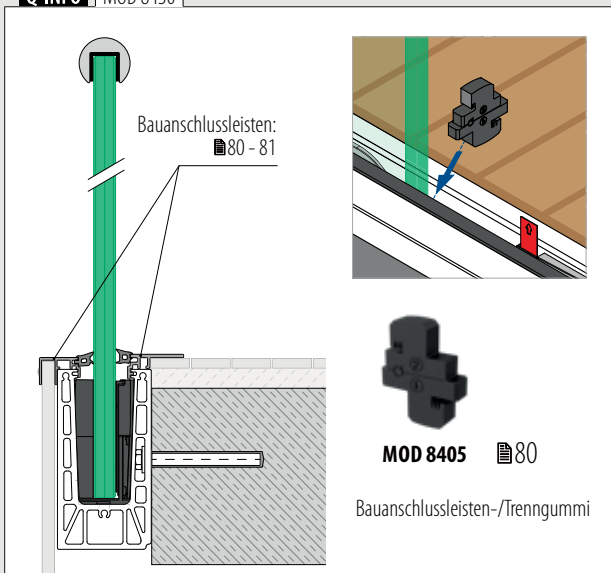

MOD 8405 80

Bauanschlussleisten-/Trenngummi

Q-INFO MOD 8430

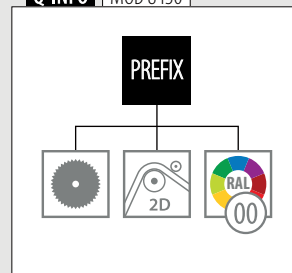

Q-INFO Aluminium



Q-INFO

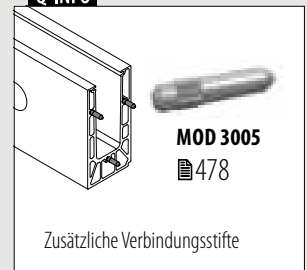

Endkappen zur Seitenmontage

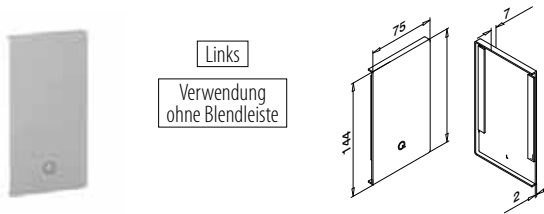

Links

Verwendung ohne Blendleiste

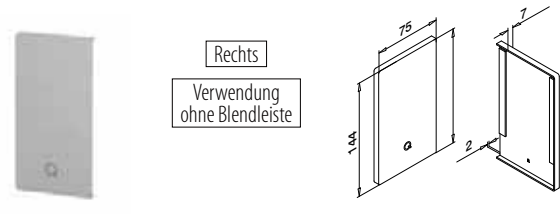

Rechts

Verwendung ohne Blendleiste

MOD 8432

Aluminium	Roh		
	Klebeband		
168432-01-00	Beigelegt	1	
Aluminium	Gebürstet		
OUTDOOR			
168432-01-18	Angebracht	1	

MOD 8432

Aluminium	Roh		
	Klebeband		
168432-02-00	Beigelegt	1	
Aluminium	Gebürstet		
OUTDOOR			
168432-02-18	Angebracht	1	

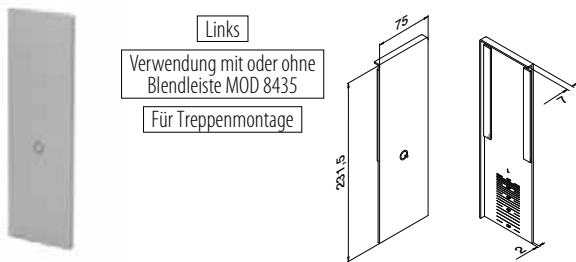

Links

Verwendung mit oder ohne Blendleiste MOD 8435

Für Treppenmontage

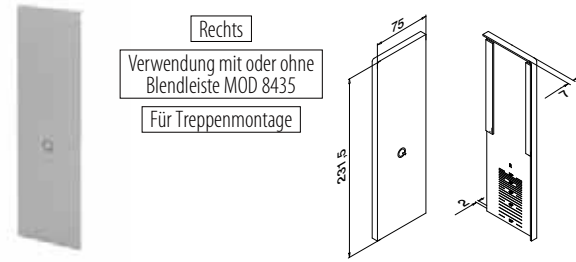

Rechts

Verwendung mit oder ohne Blendleiste MOD 8435

Für Treppenmontage

MOD 8433

Aluminium	Roh		
	Klebeband		
168433-01-00	Beigelegt	1	
Aluminium	Gebürstet		
OUTDOOR			
168433-01-18	Angebracht	1	

MOD 8433

Aluminium	Roh		
	Klebeband		
168433-02-00	Beigelegt	1	
Aluminium	Gebürstet		
OUTDOOR			
168433-02-18	Angebracht	1	



Q-INFO | MOD 8432 / 8433

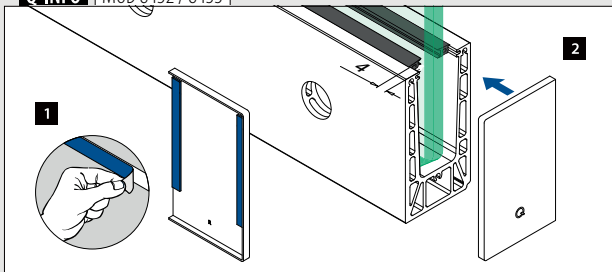

Q-INFO | MOD 8433

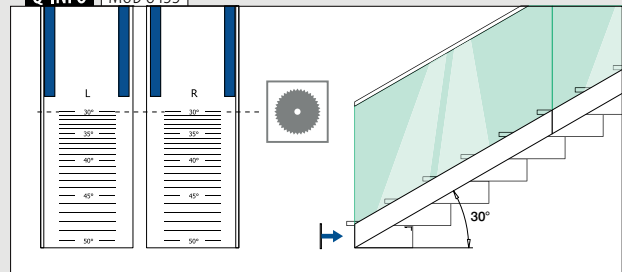

Geländerbasis

Endkappen zur Seitenmontage

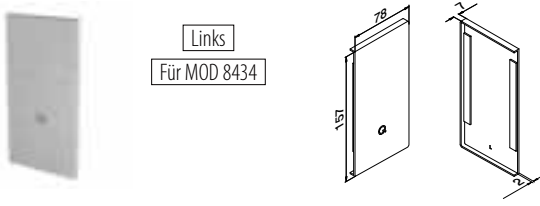

Links
Für MOD 8434

MOD 8432

Aluminium	Roh	Klebeband	
168432-41-00		Beigelegt	1
Aluminium	Gebürstet	OUTDOOR	
168432-41-18		Angebracht	1

NEW

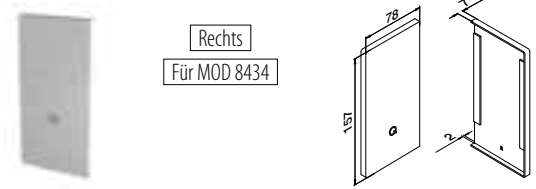

Rechts
Für MOD 8434

MOD 8432

Aluminium	Roh	Klebeband	
168432-42-00		Beigelegt	1
Aluminium	Gebürstet	OUTDOOR	
168432-42-18		Angebracht	1

NEW

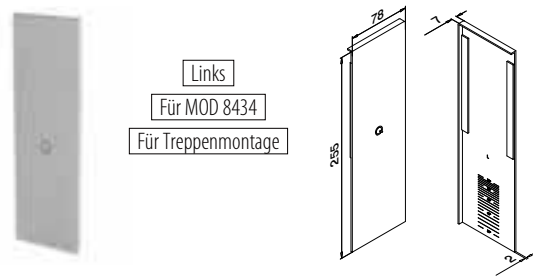

Links
Für MOD 8434
Für Treppenmontage

MOD 8433

Aluminium	Gebürstet	OUTDOOR	Klebeband	
168433-41-18			Angebracht	1

NEW

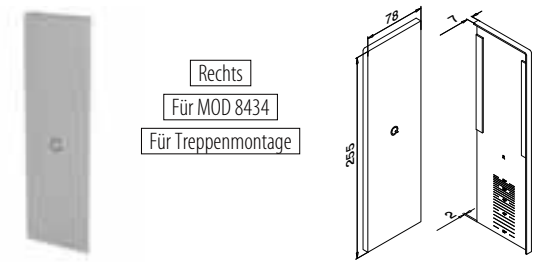

Rechts
Für MOD 8434
Für Treppenmontage

MOD 8433

Aluminium	Gebürstet	OUTDOOR	Klebeband	
168433-42-18			Angebracht	1

NEW



Q-INFO Aluminium

00

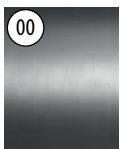

Roh

18

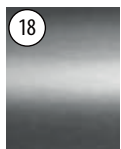

Gebürstet,
anodisiert

Drainageleisten zur Seitenmontage

4 Stück für 2,5-Meter-Bodenprofil
8 Stück für 5-Meter-Bodenprofil

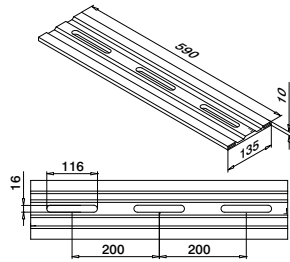

MOD 8437

Aluminium Gebürstet
OUTDOOR

168437-18	4
-----------	---

Blendstopfen zur Seitenmontage



Verwendung
ohne Blendeiste

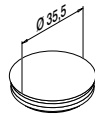

MOD 8238

Kunststoff Aluminium RAL 9006
INDOOR

158238-36	10
-----------	----

Unterlegscheiben zur Seitenmontage

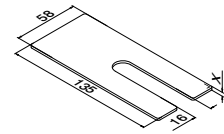

MOD 8436

Aluminium Roh

	X	
168436-001	1	100
168436-002	2	100
168436-003	3	100

Glas-Stopp



Für Treppenmontage

MOD 8404

Zubehör

208404	1
--------	---

NEW

Q-INFO MOD 8437

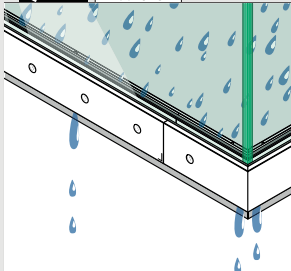

Montage-
informationen:



[https://q-ne.ws/
Prime23](https://q-ne.ws/Prime23)



Q-INFO MOD 8436

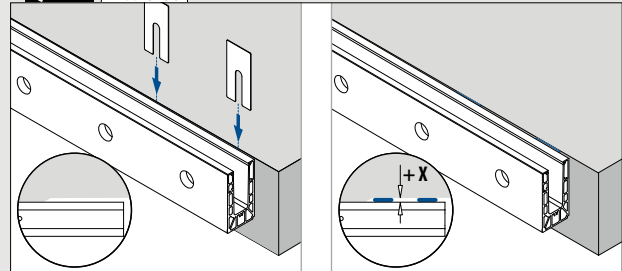

Q-INFO MOD 8238

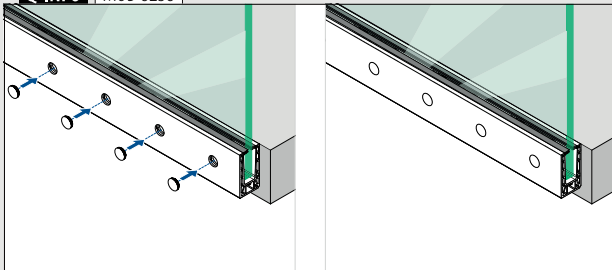

Q-INFO MOD 8404

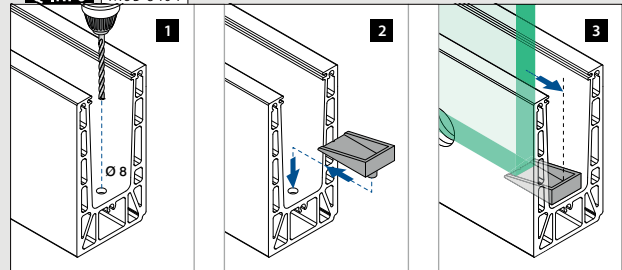

Geländerbasis

Blendleisten zur Seitenmontage

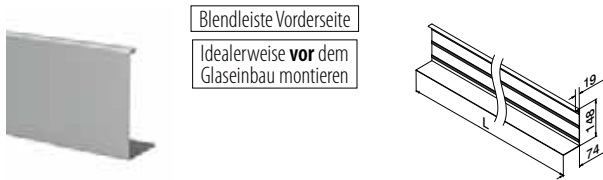

MOD 8435

Aluminium	Roh		
		Klebeband	
SELL OUT	168435-050-00	Nicht inkl.*	L = 5 m
Aluminium	Gebürstet		
		OUTDOOR	
SELL OUT	168435-050-18	Angebracht	L = 5 m



*Bestellen Sie MOD 1360 (Klebeband)

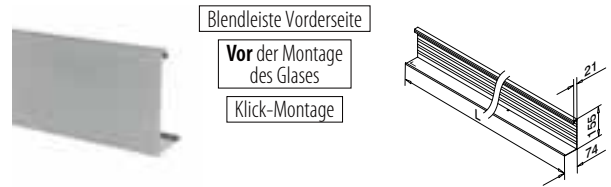

MOD 8434

Aluminium	Roh		
		Klebeband	
	168434-050-00		L = 5 m
Aluminium	Gebürstet		
		OUTDOOR	
	168434-050-18		L = 5 m



Zubehör

Acrylat-Klebeband



MOD 1360

Zubehör					
	Q	W	L		
201360	Q-53	9	33 m (für 11 m Blendleiste)	1	

Q-INFO MOD 8435-050-00 / 1360

Montage-Informationen:



<https://q-ne.ws/Prime23>

Q-INFO Aluminium

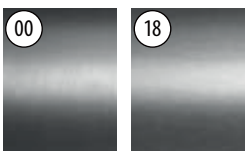

Roh

Gebürstet, anodisiert



Nur solange der Vorrat reicht.

Q-INFO MOD 8435

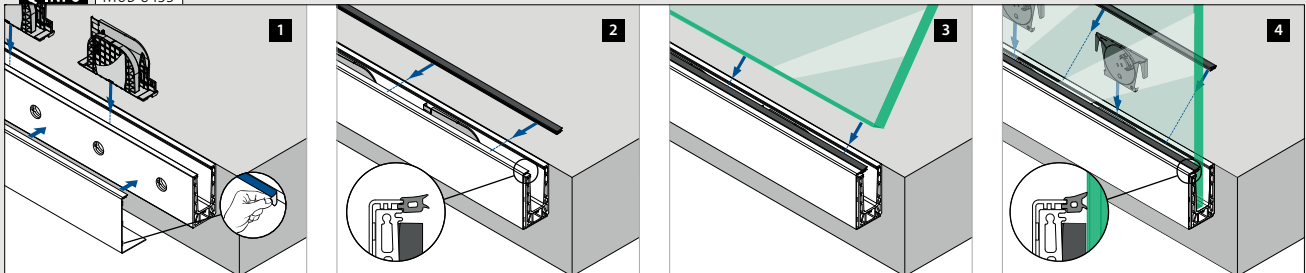

Q-INFO MOD 8434

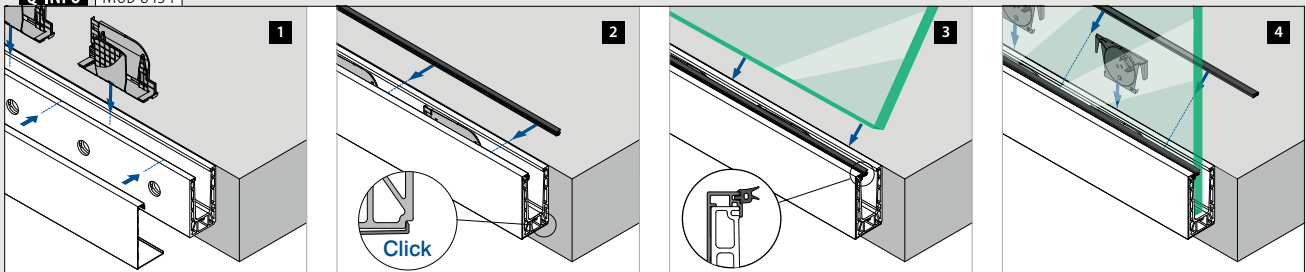

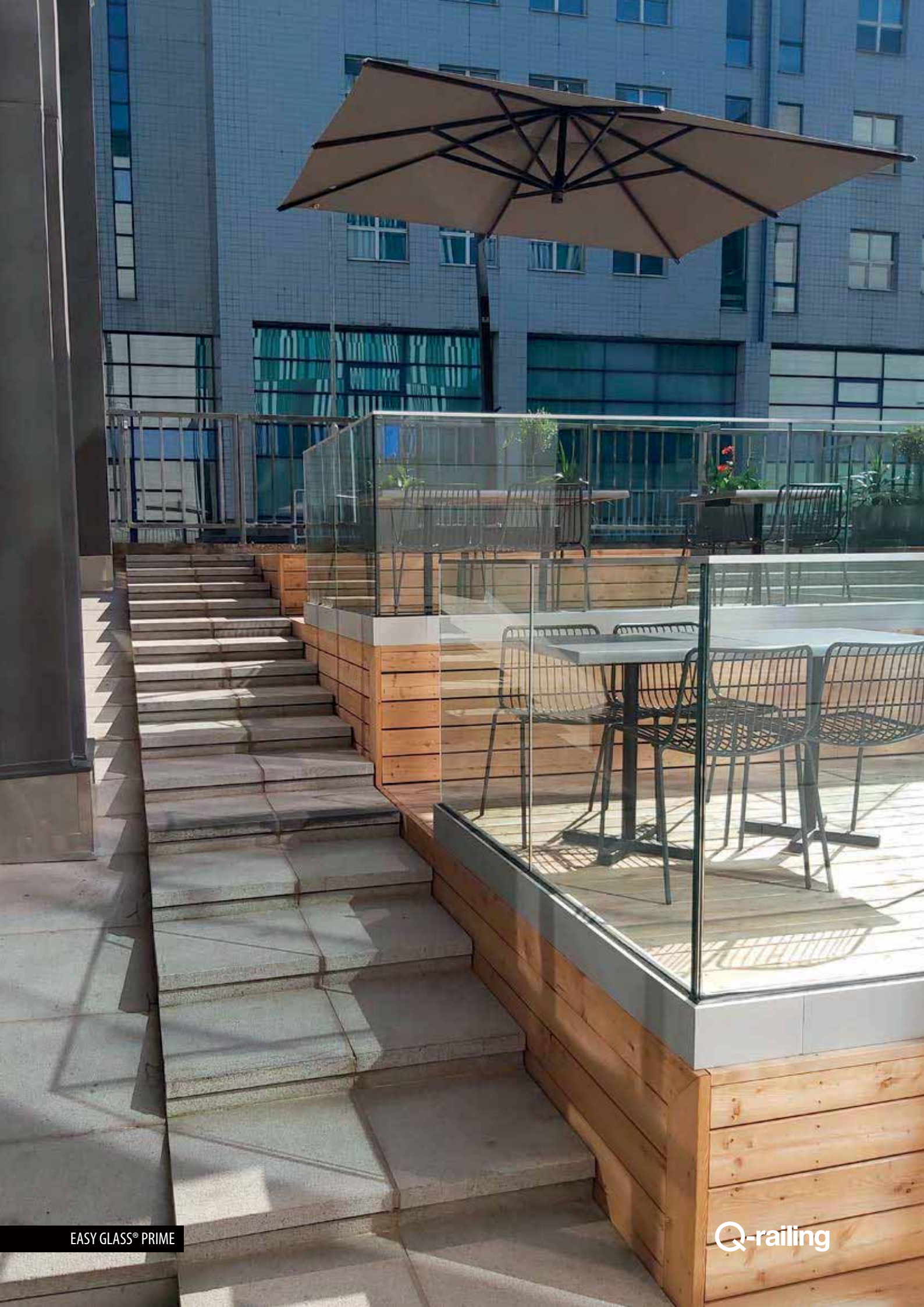

Bodenprofile zur Seitenmontage

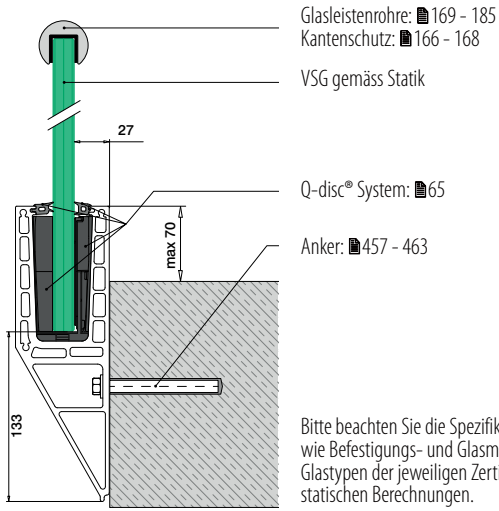

Bitte beachten Sie die Spezifikationen wie Befestigungs- und Glasmasse sowie Glastypen der jeweiligen Zertifikate und statischen Berechnungen.

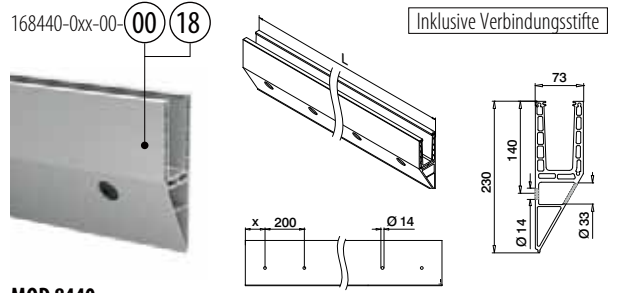

MOD 8440

Aluminium	Roh	X		
168440-050-00-00	100	457 - 463	L = 5 m	
Aluminium	Gebürstet			
OUTDOOR				
168440-025-00-18	50	457 - 463	L = 2,5 m	
168440-050-00-18	100	457 - 463	L = 5 m	



Internationaler Geschmacksmusterschutz

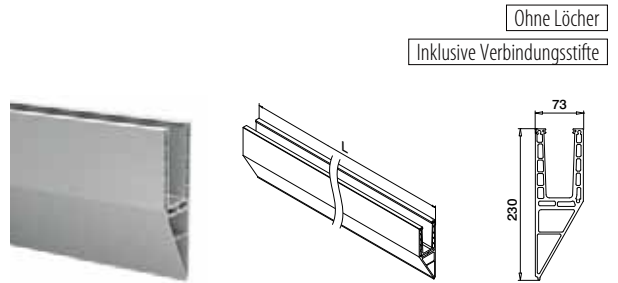

MOD 8440

Aluminium	Gebürstet		
OUTDOOR			
168440-050-99-18		L = 5 m	



Internationaler Geschmacksmusterschutz

Q-INFO

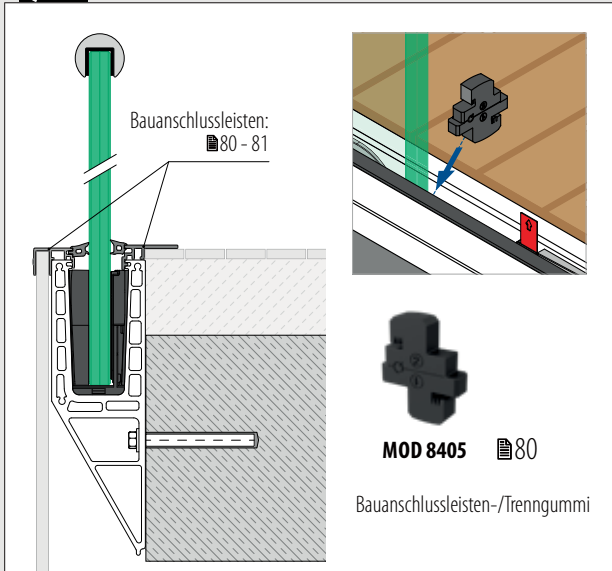

Bauanschlussleisten-/Trenngummi

Q-INFO

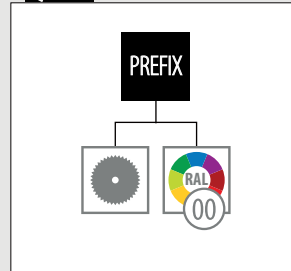

Q-INFO Aluminium



Q-INFO

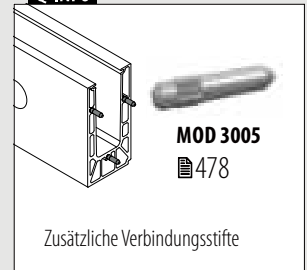

Ecken zur Seitenmontage

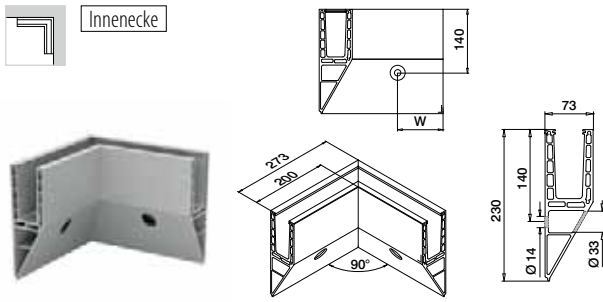

MOD 8441

Aluminium	Gebürstet			
OUTDOOR	W			
168441-01-18	100*	457 - 463	1	

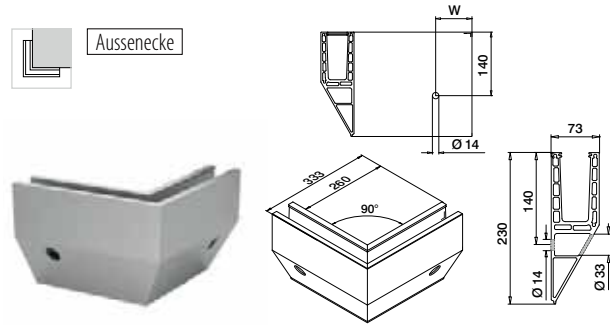

MOD 8441

Aluminium	Gebürstet			
OUTDOOR	W			
168441-02-18	100*	457 - 463	1	



*Die Lochposition kann produktionsbedingt abweichen.

Endkappen zur Seitenmontage

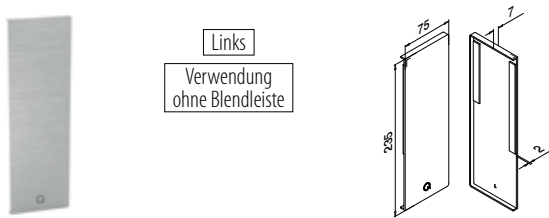

MOD 8442

Aluminium	Roh			
	Kleband			
168442-01-00	Beigelegt		1	
Aluminium	Gebürstet			
OUTDOOR				
168442-01-18	Angebracht		1	

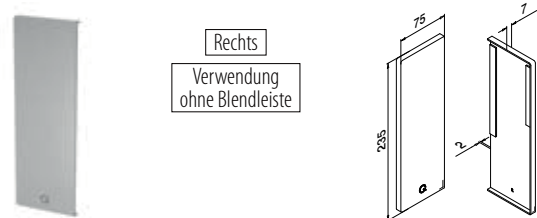

MOD 8442

Aluminium	Roh			
	Kleband			
168442-02-00	Beigelegt		1	
Aluminium	Gebürstet			
OUTDOOR				
168442-02-18	Angebracht		1	

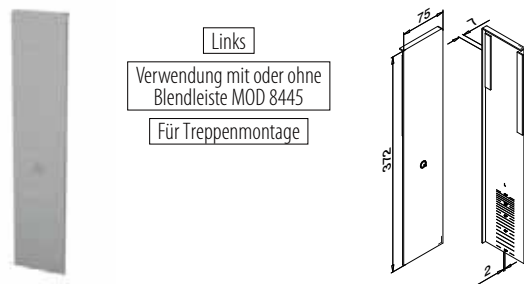

MOD 8443

Aluminium	Gebürstet			
OUTDOOR	Kleband			
168443-01-18	Angebracht		1	

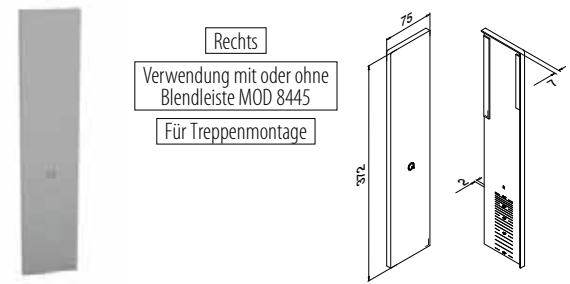

MOD 8443

Aluminium	Gebürstet			
OUTDOOR	Kleband			
168443-02-18	Angebracht		1	



Q-INFO | MOD 8442 / 8443

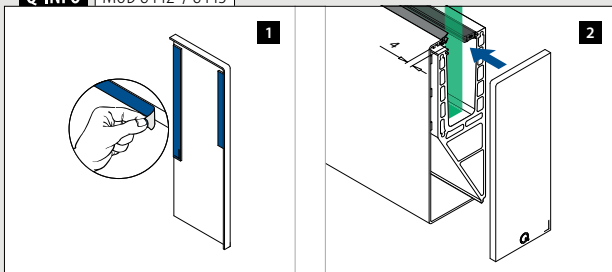

Q-INFO | MOD 8443

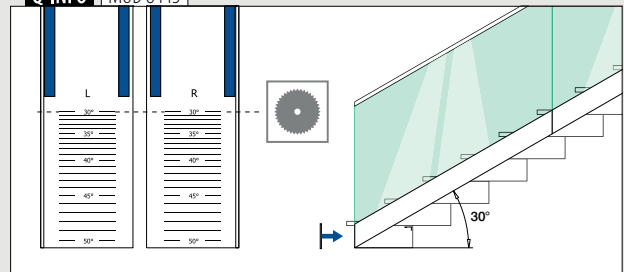

Geländerbasis

Endkappen zur Seitenmontage



Links
Für MOD 8444

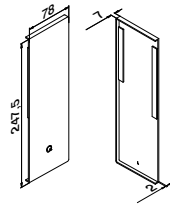

Rechts
Für MOD 8444

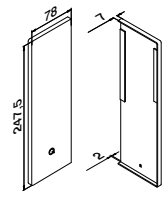

MOD 8442

Aluminium	Roh	Klebeband	
168442-41-00	Beigelegt		1
Aluminium	Gebürstet	OUTDOOR	
168442-41-18	Angebracht		1

NEW

MOD 8442

Aluminium	Roh	Klebeband	
168442-42-00	Beigelegt		1
Aluminium	Gebürstet	OUTDOOR	
168442-42-18	Angebracht		1

NEW



Links
Für MOD 8444
Für Treppenmontage

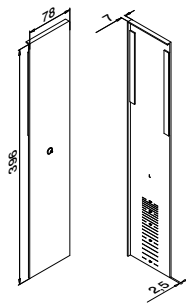

Rechts
Für MOD 8444
Für Treppenmontage

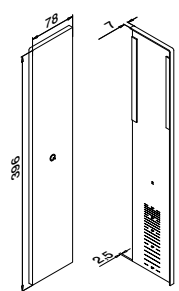

MOD 8443

Aluminium	Gebürstet	OUTDOOR	Klebeband	
168443-41-18	Angebracht			1

NEW



MOD 8443

Aluminium	Gebürstet	OUTDOOR	Klebeband	
168443-42-18	Angebracht			1

NEW



Geländerbasis

Glas-Stopp



Für Treppenmontage

MOD 8404

Zubehör		
208404		1

NEW

Q-INFO | MOD 8404

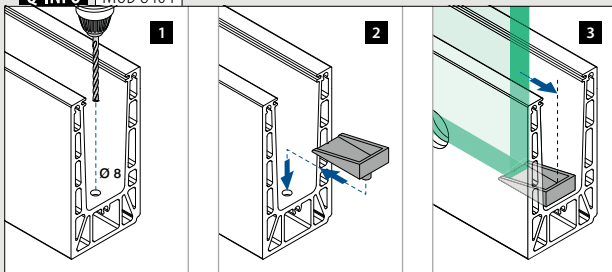

Q-INFO | Aluminium



Blendleisten zur Seitenmontage

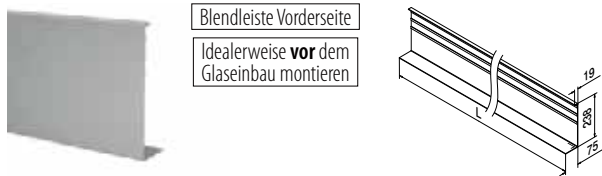

MOD 8445

Aluminium Roh			
Klebeband			
SELL OUT 168445-050-00	Nicht inkl.*	L = 5 m	
Aluminium Gebürstet			
OUTDOOR			
SELL OUT 168445-050-18	Angebracht	L = 5 m	



*Bestellen Sie MOD 1360 (Klebeband)



MOD 8444

Aluminium Roh			
Klebeband			
168444-050-00		L = 5 m	
Aluminium Gebürstet			
OUTDOOR			
168444-050-18		L = 5 m	



Zubehör

Acrylat-Klebeband



MOD 1360

Zubehör					
	Q	W	L		
201360	Q-53	9	33 m (für 11 m Blendleiste)	1	

Q-INFO MOD 8445-050-00 / 1360

Montage-Informationen:



<https://q-ne.ws/Prime23>

SELL OUT Nur solange der Vorrat reicht.

Q-INFO MOD 8445

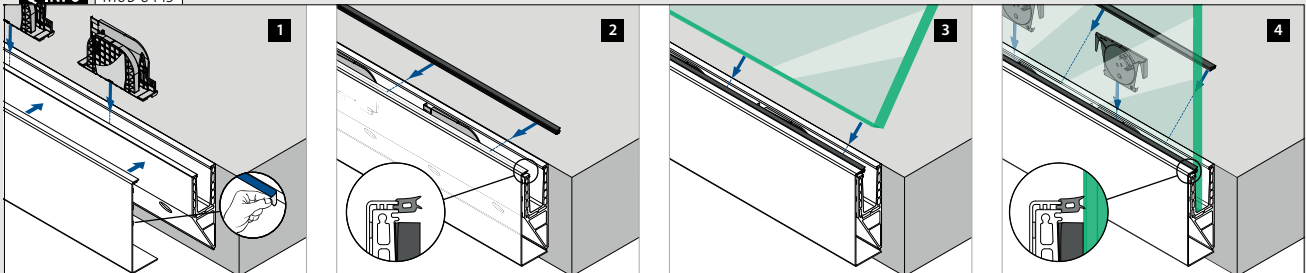

Q-INFO MOD 8444

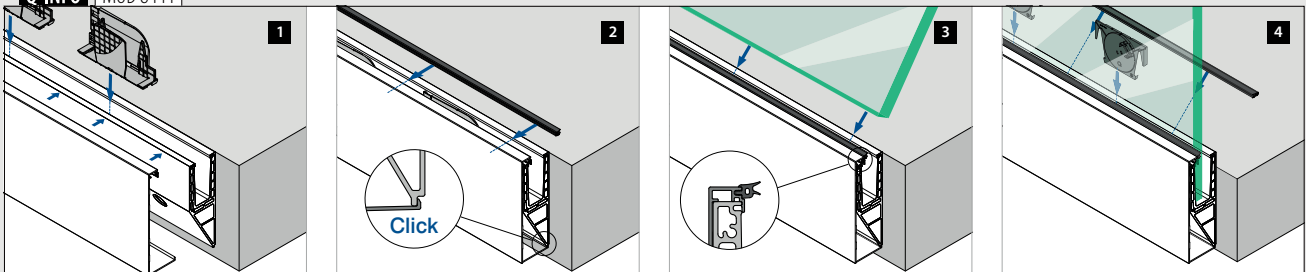

Geländerbasis

Bauanschlussleisten

Für alle Prime-Profile

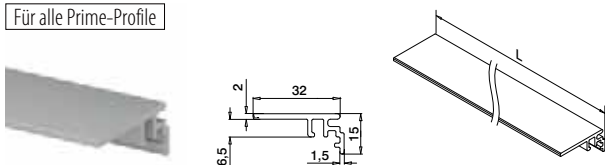

MOD 6973

Aluminium	Roh		
166973-50-00		L = 5 m	
Aluminium	Gebürstet		
OUTDOOR			
166973-50-18		L = 5 m	

PREFIX

Für Prime **Boden-**
montage-Profile

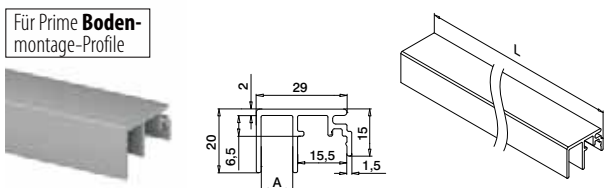

MOD 6970

Aluminium	Roh	A	
166970-010-50-00		10	L = 5 m
Aluminium	Gebürstet		
OUTDOOR			
166970-010-50-18		10	L = 5 m

PREFIX

Für alle Prime-Profile

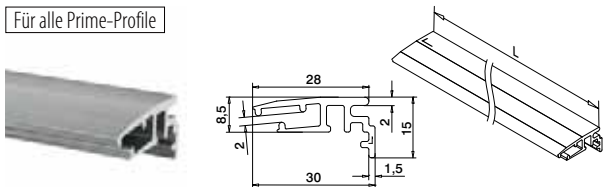

MOD 6979

Aluminium	Roh		
166979-002-50-00		L = 5 m	
Aluminium	Gebürstet		
OUTDOOR			
166979-002-50-18		L = 5 m	

NEW

PREFIX

Für Prime **Boden-**
montage-Profile

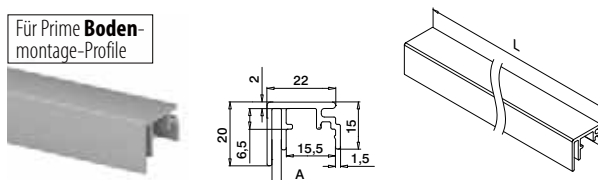

MOD 6970

Aluminium	Roh	A	
166970-003-50-00		3	L = 5 m
Aluminium	Gebürstet		
OUTDOOR			
166970-003-50-18		3	L = 5 m

PREFIX

Für Prime **Boden-**
montage-Profile

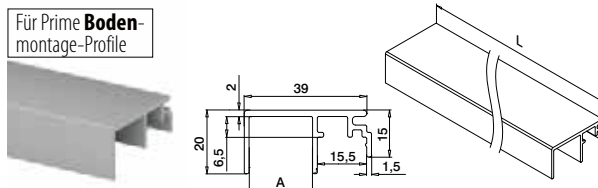

MOD 6970

Aluminium	Roh	A	
166970-020-50-00		20	L = 5 m
Aluminium	Gebürstet		
OUTDOOR			
166970-020-50-18		20	L = 5 m

PREFIX

Geländerbasis

Bauanschlussleisten-/Trenngummi

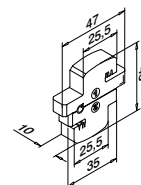

MOD 8405

Zubehör			
208405-010		5	



Q-INFO Aluminium

Roh	Gebürstet, anodisiert

Q-INFO

PREFIX

Q-INFO MOD 8405

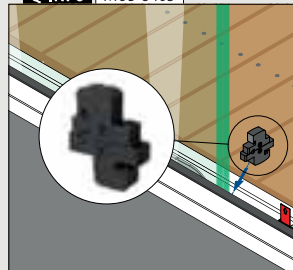

Bauanschlussleisten

Für alle Prime-Profile

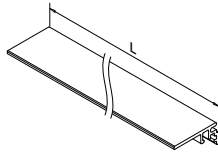
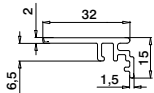

MOD 6973

Aluminium	Roh		
166973-50-00		L = 5 m	
Aluminium	Gebürstet		
OUTDOOR			
166973-50-18		L = 5 m	

PREFIX

Für Prime **F-, Seiten-**montage- und **Y-**Profile

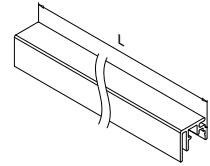
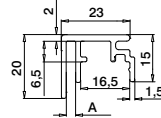

MOD 6974

Aluminium	Roh	A	
166974-003-50-00		3	L = 5 m
Aluminium	Gebürstet		
OUTDOOR			
166974-003-50-18		3	L = 5 m

PREFIX

Für Prime **F-, Seiten-**montage- und **Y-**Profile

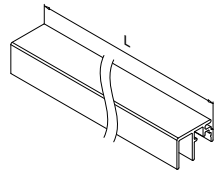
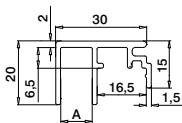

MOD 6974

Aluminium	Roh	A	
166974-010-50-00		10	L = 5 m
Aluminium	Gebürstet		
OUTDOOR			
166974-010-50-18		10	L = 5 m

PREFIX

Für Prime **F-, Seiten-**montage- und **Y-**Profile

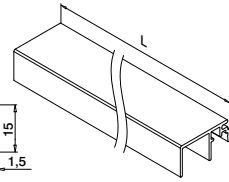
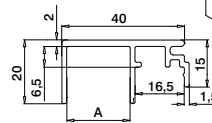

MOD 6974

Aluminium	Roh	A	
166974-020-50-00		20	L = 5 m
Aluminium	Gebürstet		
OUTDOOR			
166974-020-50-18		20	L = 5 m

PREFIX

Q-INFO MOD 6979

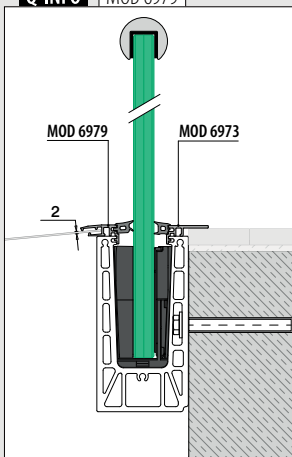

Q-INFO MOD 6970 / 6973

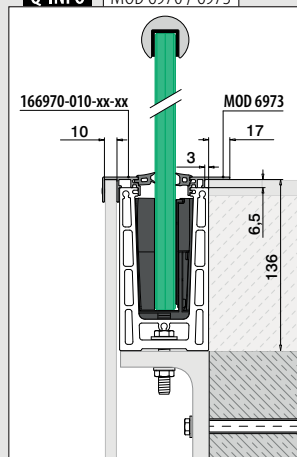

Q-INFO MOD 6974 / 6973

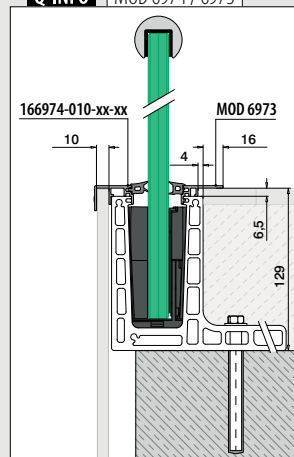

Q-INFO MOD 6974 / 6973

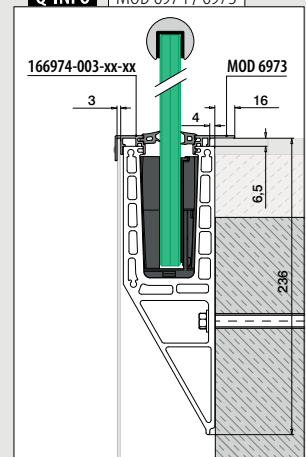



- Beanspruchung:** Hoch und besonders hoch
Verwendung: Innen- und Aussenbereich
Montage: Boden-, In-Boden- und Seitenmontage
Anwendung: Balkone, Galerien, Wege, Abtrennungen und Treppen
Material: Aluminium (gebürstet anodisiert und roh)
Glasstärke: 21,52 bis 33,04 mm

Finden Sie alle Informationen zu Easy Glass Strong online:



<https://q-ne.ws/Strong23>

EASY GLASS[®] STRONG



reddot winner 2020
innovative product



Ein Kraftpaket einfach installiert

Unser neues Kraftpaket mit dem revolutionären Q-disc® System heisst Easy Glass® Strong. Die Kombination aus Stärke und Funktionalität macht dieses System ideal für öffentliche Gebäude wie Stadien, Flughäfen oder Einkaufszentren. Dank des integrierten Q-disc Systems wird die Montage deutlich beschleunigt: Befestigen Sie das Bodenprofil am Boden, setzen Sie das Glas ein und fixieren Sie es – mit einer Handdrehung – im Profil. Mit der justierbaren Variante des Q-disc Systems lassen sich die einzelnen Glasscheiben in der Vertikalen ausrichten. Natürlich finden Sie in dieser Serie weitere passende Komponenten, um Ihr Geländerprojekt zu realisieren.

Easy Glass® Strong	CH
Max. Holmlast (kN/m)	3,0

Bitte beachten Sie die Spezifikationen wie Befestigungs- und Glasmasse sowie Glastypen der jeweiligen Zertifikate.

International getestet/berechnet/zertifiziert:



- 1 Mit dem justierbaren Q-disc System können Sie die Glasscheiben um bis zu 0,3° in der Vertikalen ausrichten.
- 2 Mit einem Klickgeräusch signalisiert die Q-disc die korrekte Installation.
- 3 Auch geeignet für 3-Scheiben-Sicherheitsglas (Glasstärken bis zu 33,04 mm).

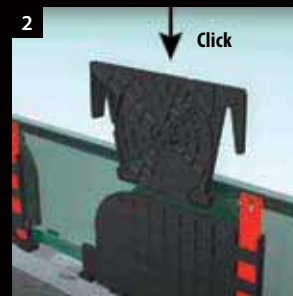
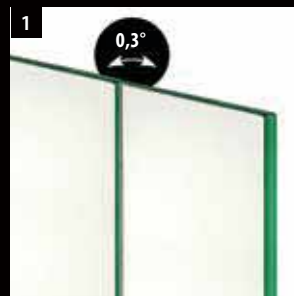

EASY GLASS® STRONG MONTAGEOPTIONEN

Strong Bodenmontage

- Auch für In-Bodenmontage geeignet

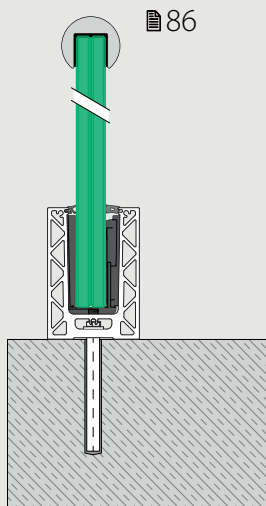

Strong Seitenmontage

- Auch zur Montage an der Innenseite von Aufmauerungen
- Bodenprofil-Blendleiste erhältlich

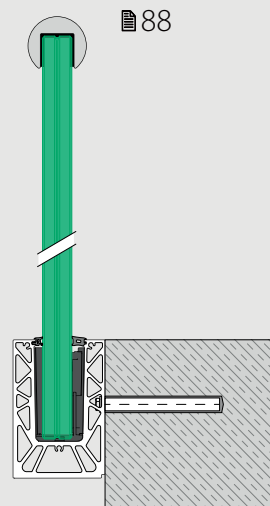

COMING SOON

F und Y Bodenprofile

Strong F Bodenmontage

- Für Rohfußböden
- Kann direkt an oder über der Bodenkante angebracht werden

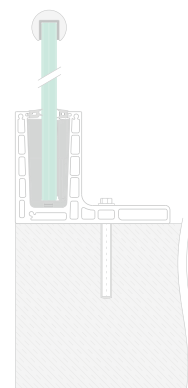

Strong Y Seitenmontage

- Für Rohfußböden
- Kann direkt an oder über der Bodenkante angebracht werden

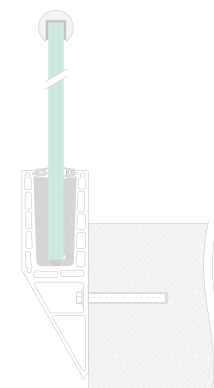



JUSTIERBARES Q-DISC® SYSTEM SCHIEBEN UND AUSRICHTEN!



SO FUNKTIONIERT'S

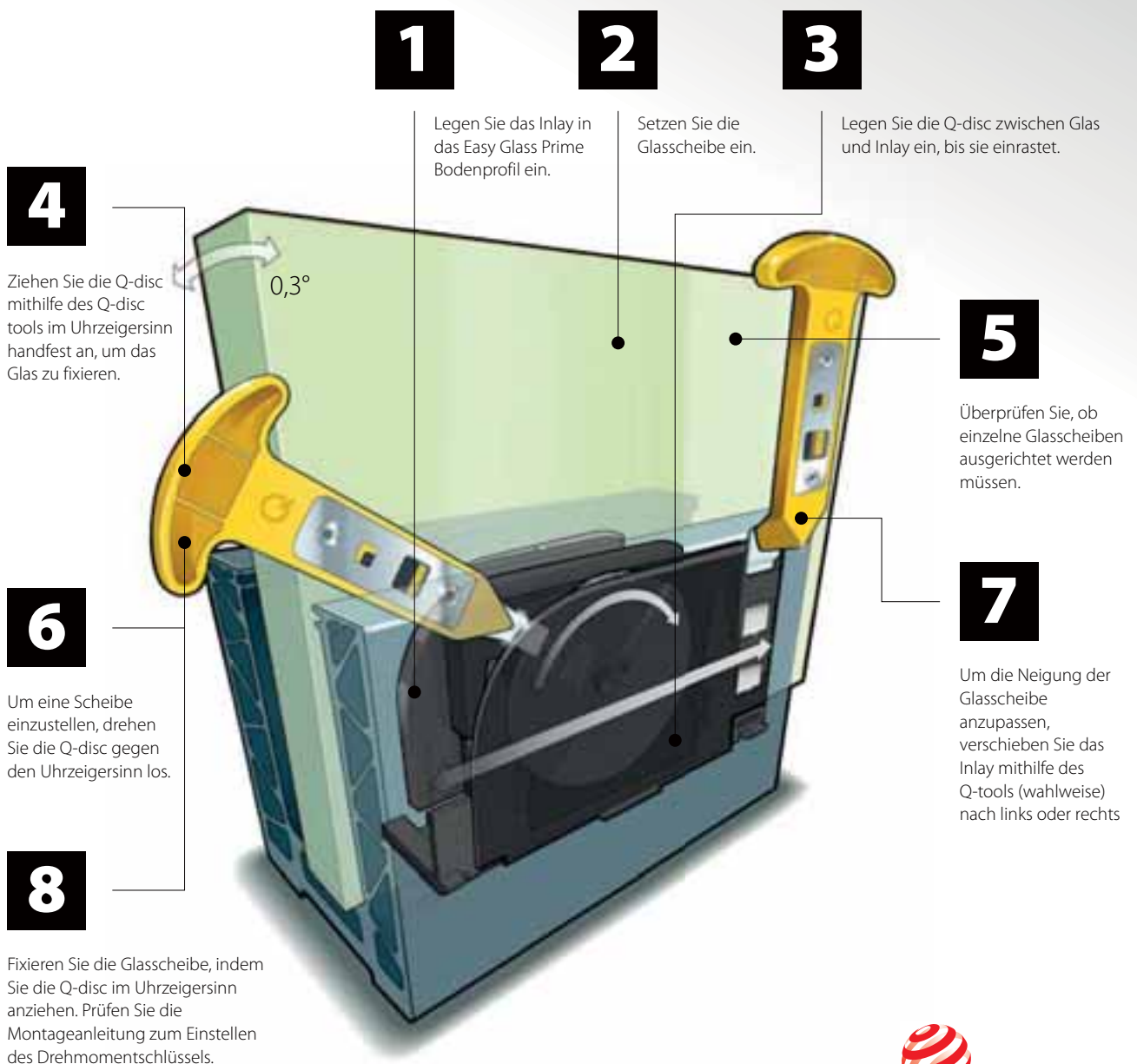

reddot winner 2020
innovative product

Q-disc® System (Gummi, Inlay und Q-disc®)

Glasklemmung und -justierung



MOD 8601

Zubehör		
Für laminiertes Glas	T	
208601-025-22	21,52	L = 2,5 m
208601-025-26	25,52	L = 2,5 m
208601-025-32	31,52	L = 2,5 m
208601-025-34	33,04	L = 2,5 m
208601-250-22	21,52	L = 25 m
208601-250-26	25,52	L = 25 m
208601-250-32	31,52	L = 25 m
208601-250-34	33,04	L = 25 m



Internationaler Geschmacksmusterschutz

Q-disc®- und Inlay-Werkzeug



MOD 1000

Zubehör		
	Q	
201000	Q-84	1

Einzelne Gummis



MOD 8207

Zubehör		
208207-250-00	L = 25 m	



MOD 8607 / 8207

Zubehör		
Für laminiertes Glas	T	
208607-250-22	21,52	L = 25 m
208607-250-26	25,52	L = 25 m
208207-250-15	31,52	L = 25 m
208207-250-18	33,04	L = 25 m



Q-disc®-Sets

Glasklemmung und -justierung



MOD 8609

Zubehör		
	T	
208609-22	21,52	5
208609-26	25,52	5
208609-32	31,52	5
208609-34	33,04	5



Q-INFO MOD 1000

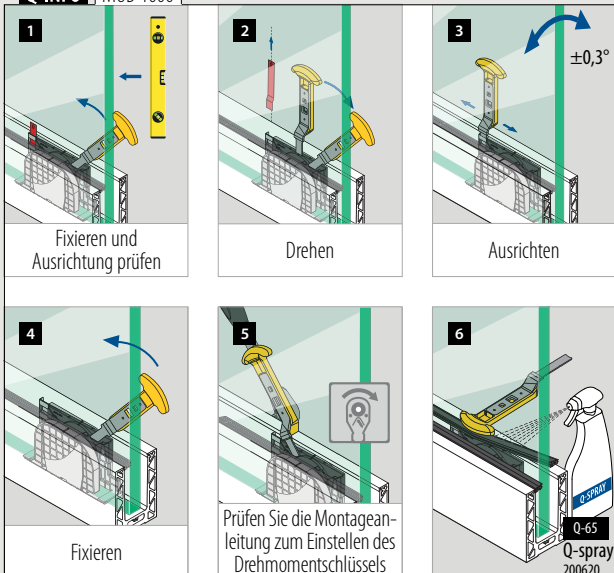

Q-INFO

Installationsblech

MOD 1002

480



Geländerbasis

Bodenprofile zur Bodenmontage

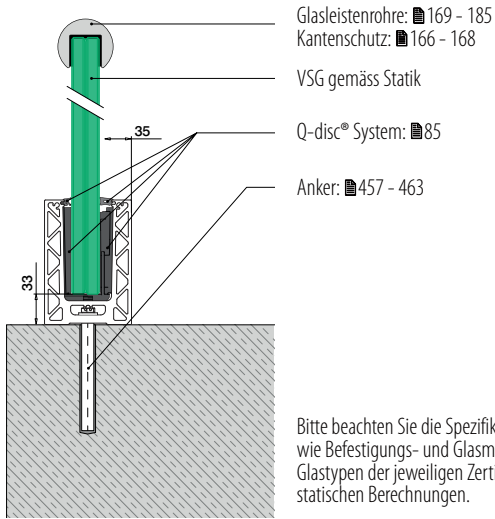

Bitte beachten Sie die Spezifikationen wie Befestigungs- und Glasmasse sowie Glastypen der jeweiligen Zertifikate und statischen Berechnungen.

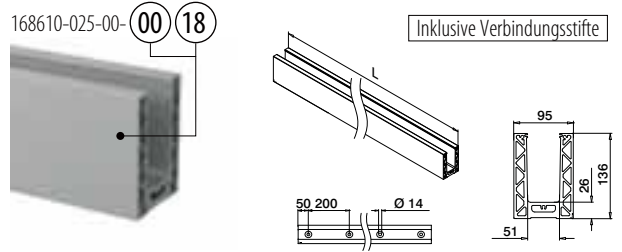

MOD 8610

Aluminium	Roh		
168610-025-00-00	457 - 463		L = 2,5 m
Aluminium	Gebürstet		
OUTDOOR			
168610-025-00-18	457 - 463		L = 2,5 m



Geländerbasis

Ecken zur Bodenmontage

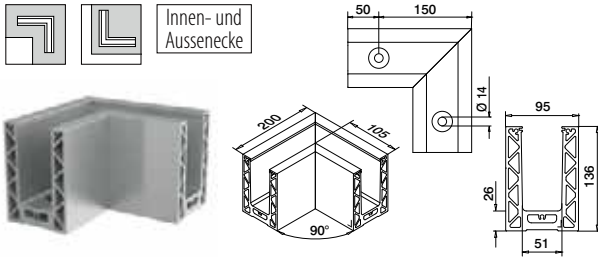

MOD 8611

Aluminium	Roh		
168611-00-00	457 - 463		1
Aluminium	Gebürstet		
OUTDOOR			
168611-00-18	457 - 463		1



Internationaler Geschmacksmusterschutz

Q-INFO MOD 8610

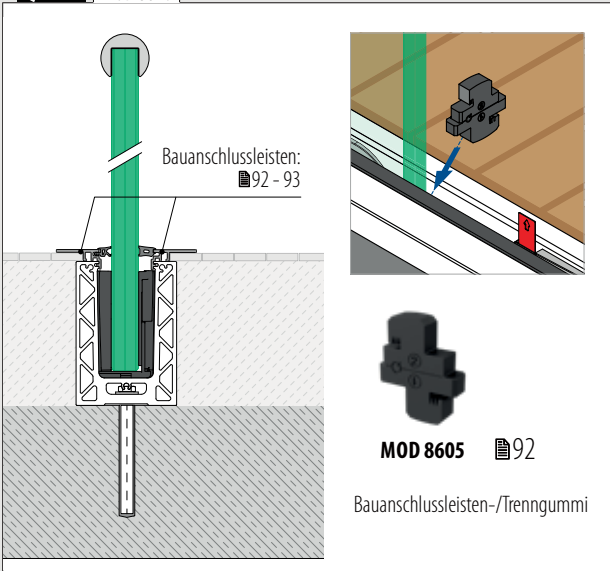

Q-INFO MOD 8610

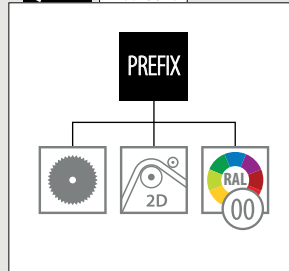

Q-INFO Aluminium



Q-INFO

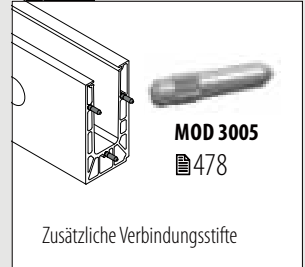

Endkappen zur Bodenmontage



MOD 8612

Aluminium Roh		
	Klebeband	
168612-00-00	Beigelegt	1
Aluminium Gebürstet		
OUTDOOR		
168612-00-18	Angebracht	1

NEW

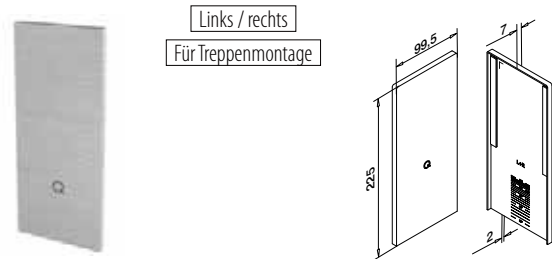

MOD 8613

Aluminium Roh		
	Klebeband	
168613-00-00	Beigelegt	1
Aluminium Gebürstet		
OUTDOOR		
168613-00-18	Angebracht	1

NEW



Unterlegscheiben zur Bodenmontage

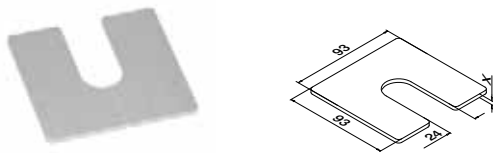

MOD 8616

Aluminium Roh		
	X	
168616-001	1	100
168616-002	2	100
168616-003	3	100

NEW

Drainageleisten zur Bodenmontage

4 Stück für 2,5-Meter-Bodenprofil

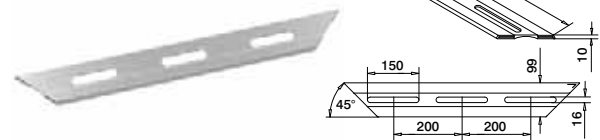

MOD 8617

Aluminium Gebürstet		
	OUTDOOR	
168617-18		4

NEW

Q-INFO MOD 8612

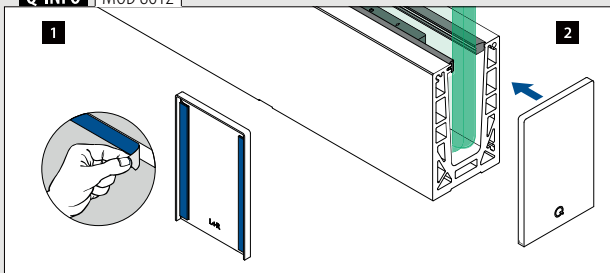

Q-INFO MOD 8616

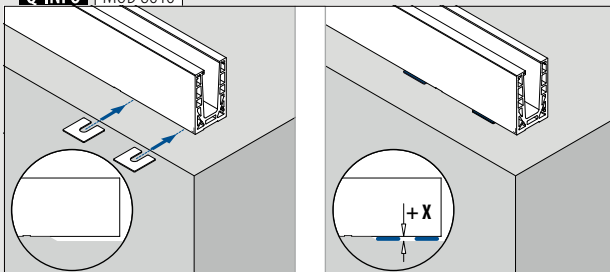

Q-INFO MOD 8613

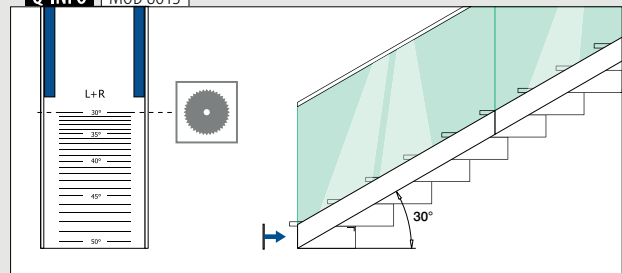

Q-INFO MOD 8617

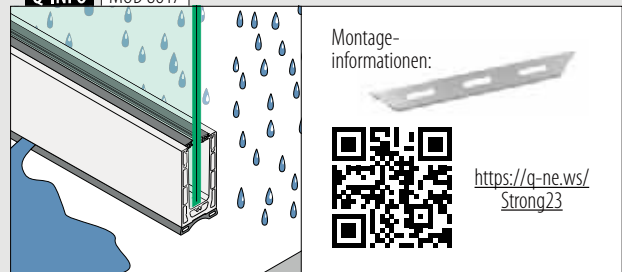

Geländerbasis

Bodenprofile zur Seitenmontage

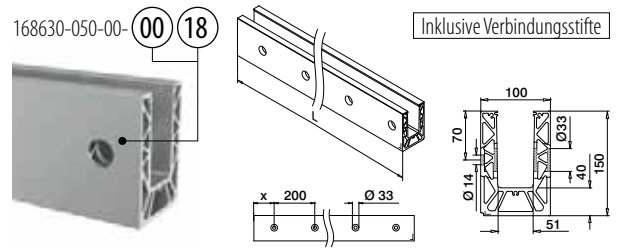
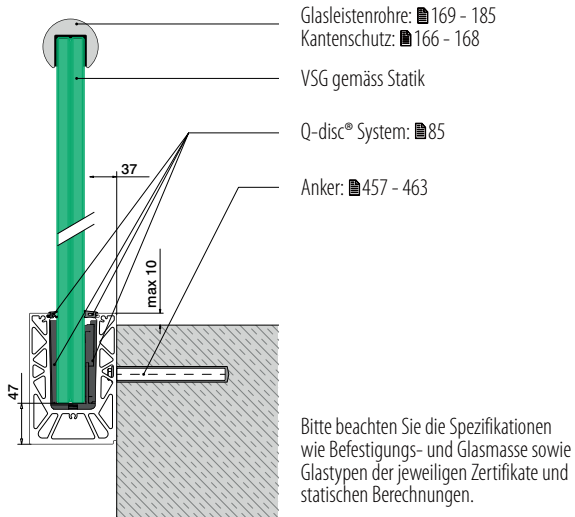

MOD 8630

Aluminium	Roh	X		
168630-025-00-00	100	■ 457 - 463	L = 2,5 m	
Aluminium	Gebürstet			
OUTDOOR				
168630-025-00-18	100	■ 457 - 463	L = 2,5 m	



Internationaler Geschmacksmusterschutz

Geländerbasis

Ecken zur Seitenmontage

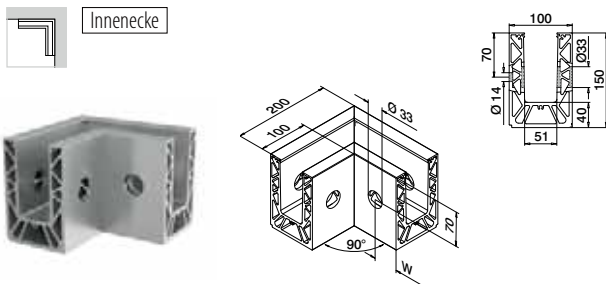

MOD 8631

Aluminium	Roh	W		
168631-01-00	50*	■ 457 - 463	1	
Aluminium	Gebürstet			
OUTDOOR				
168631-01-18	50*	■ 457 - 463	1	

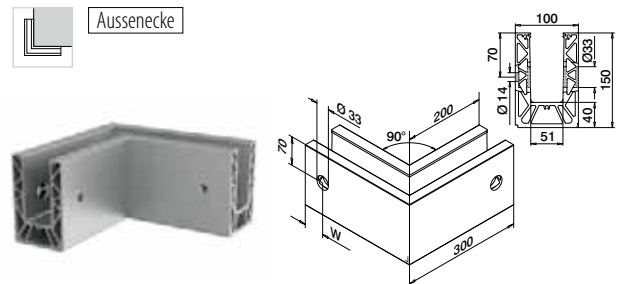

MOD 8631

Aluminium	Roh	W		
168631-02-00	50*	■ 457 - 463	1	
Aluminium	Gebürstet			
OUTDOOR				
168631-02-18	50*	■ 457 - 463	1	



*Die Lochposition kann produktionsbedingt abweichen.

Q-INFO MOD 8630

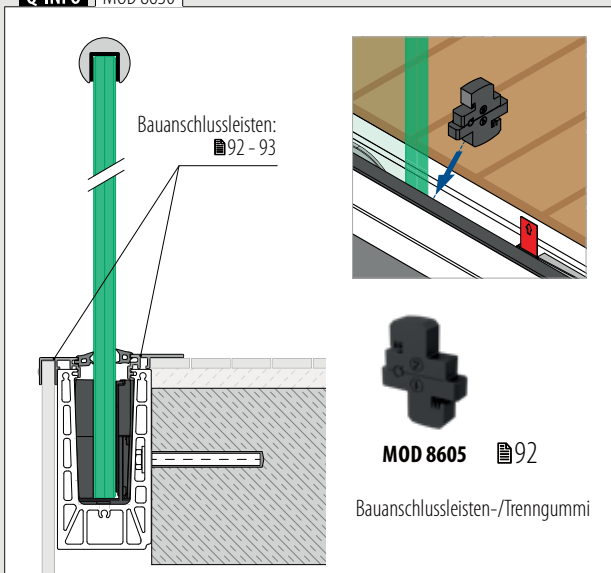

Q-INFO MOD 8630

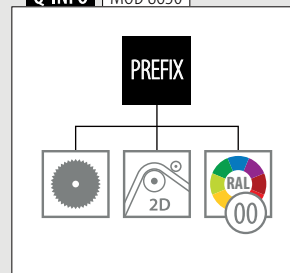

Q-INFO Aluminium



Q-INFO

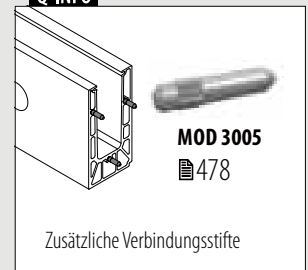

Endkappen zur Seitenmontage



Links

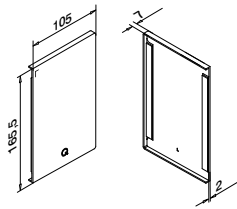

MOD 8632

Aluminium	Roh		
	Klebeband		
168632-41-00	Beigelegt	1	
Aluminium	Gebürstet		
OUTDOOR			
168632-41-18	Angebracht	1	

NEW



Rechts

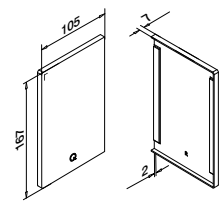

MOD 8632

Aluminium	Roh		
	Klebeband		
168632-42-00	Beigelegt	1	
Aluminium	Gebürstet		
OUTDOOR			
168632-42-18	Angebracht	1	

NEW



Links

Für Treppenmontage

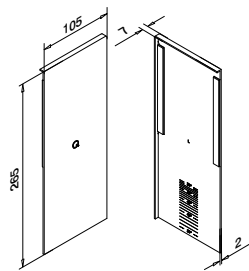

MOD 8633

Aluminium	Gebürstet		
OUTDOOR	Klebeband		
168633-41-18	Angebracht	1	

NEW



Rechts

Für Treppenmontage

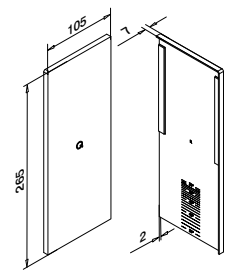

MOD 8633

Aluminium	Gebürstet		
OUTDOOR	Klebeband		
168633-42-18	Angebracht	1	

NEW



Geländerbasis

Drainageleisten zur Seitenmontage

4 Stück für 2,5-Meter-Bodenprofil

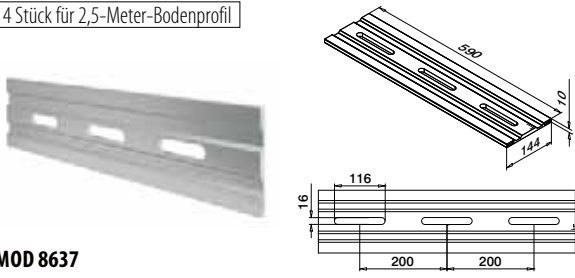

MOD 8637

Aluminium Gebürstet

OUTDOOR

168637-18



4

NEW

Geländerbasis

Unterlegscheiben zur Seitenmontage

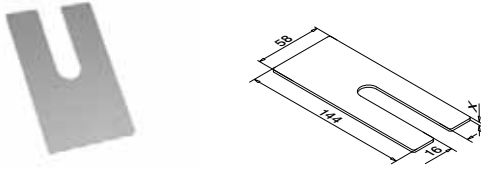

MOD 8636

Aluminium Roh

	X	
168636-001	1	100
168636-002	2	100
168636-003	3	100

NEW

Q-INFO MOD 8637

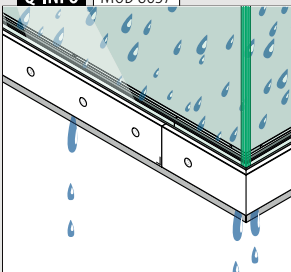

Montage-
informationen:



<https://q-ne.ws/Strong23>

Q-INFO MOD 8636

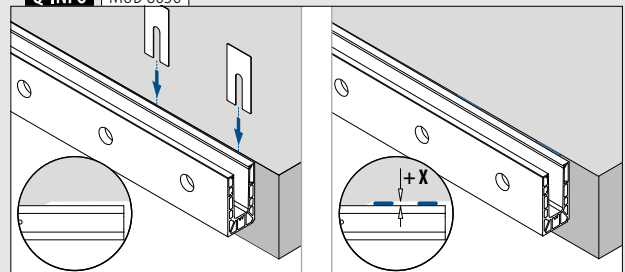

Blendstopfen zur Seitenmontage

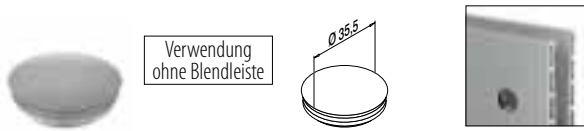

Verwendung
ohne Blendleiste

MOD 8238

Kunststoff	Aluminium RAL 9006
INDOOR	
158238-36	10

Blendleisten zur Seitenmontage

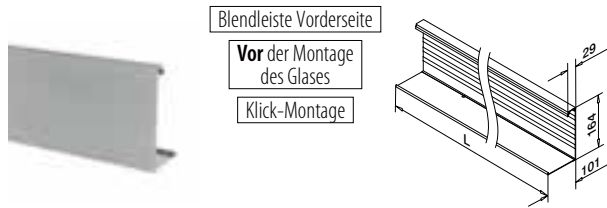

Blendleiste Vorderseite

Vor der Montage
des Glases

Klick-Montage

MOD 8634

Aluminium	Roh
	
168634-050-00	L = 5 m
Aluminium	Gebürstet
OUTDOOR	
168634-050-18	L = 5 m



Q-INFO MOD 8238

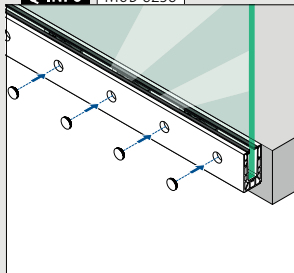

Q-INFO Aluminium

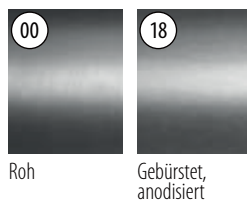

Q-INFO MOD 8634

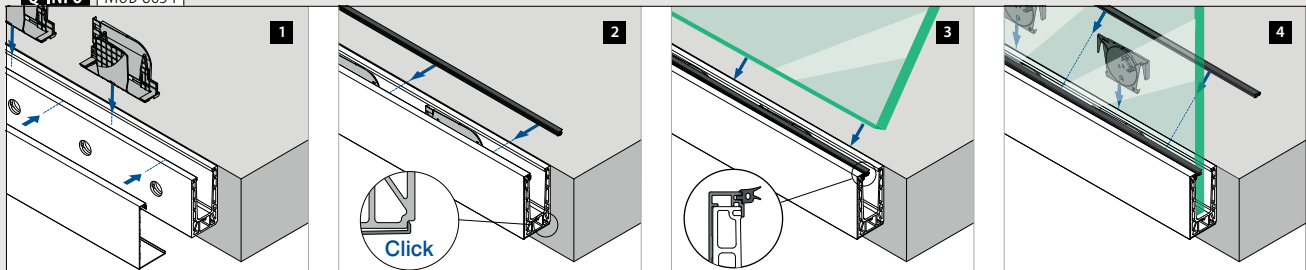

Geländerbasis

Bauanschlussleisten

Für alle Strong-Profile

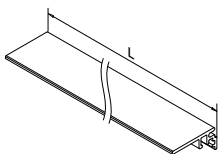
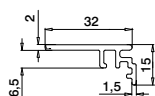

MOD 6973

Aluminium	Roh	
166973-50-00		L = 5 m
Aluminium	Gebürstet	
OUTDOOR		
166973-50-18		L = 5 m

PREFIX

Für Strong **Boden-**
montage-Profile

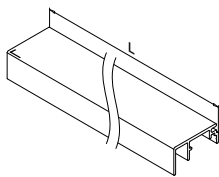
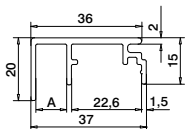

MOD 6975

Aluminium	Roh	
	A	
166975-010-50-00	10	L = 5 m
Aluminium	Gebürstet	
OUTDOOR		
166975-010-50-18	10	L = 5 m

NEW

PREFIX

Für alle Strong-Profile

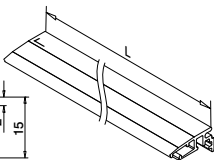
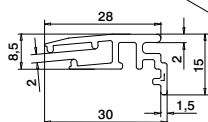

MOD 6979

Aluminium	Roh	
166979-002-50-00		L = 5 m
Aluminium	Gebürstet	
OUTDOOR		
166979-002-50-18		L = 5 m

NEW

PREFIX

Für Strong **Boden-**
montage-Profile

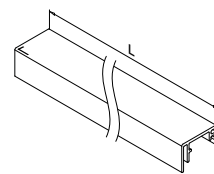
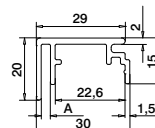

MOD 6975

Aluminium	Roh	
	A	
166975-003-50-00	3	L = 5 m
Aluminium	Gebürstet	
OUTDOOR		
166975-003-50-18	3	L = 5 m

NEW

PREFIX

Für Strong **Boden-**
montage-Profile

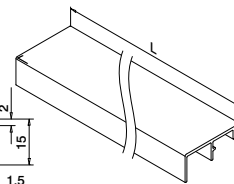
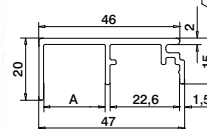

MOD 6975

Aluminium	Roh	
	A	
166975-020-50-00	20	L = 5 m
Aluminium	Gebürstet	
OUTDOOR		
166975-020-50-18	20	L = 5 m

NEW

PREFIX

Geländerbasis

Bauanschlussleisten-/Trenngummi

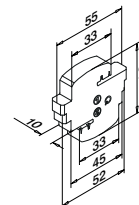

MOD 8605

Zubehör	
208605-010	5

NEW

PREFIX

Q-INFO Aluminium

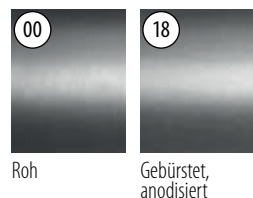

Roh

Gebürstet,
anodisiert

Q-INFO

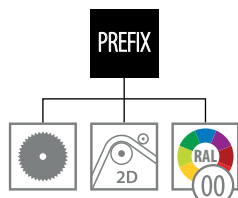

Q-INFO MOD 8605

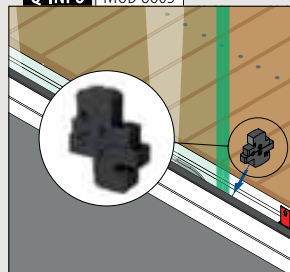

Bauanschlussleisten

Für alle Strong-Profile

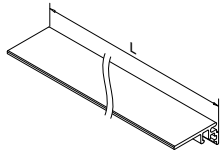
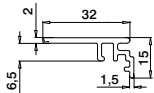

MOD 6973

Aluminium	Roh		
166973-50-00		L = 5 m	
Aluminium	Gebürstet		
OUTDOOR			
166973-50-18		L = 5 m	

PREFIX

Für Strong Seitenmontage-Profile

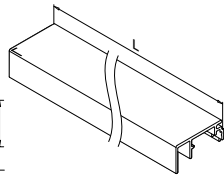
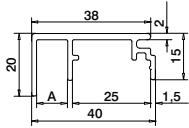

MOD 6977

Aluminium	Roh	A	
166977-010-50-00		10	L = 5 m
Aluminium	Gebürstet		
OUTDOOR			
166977-010-50-18		10	L = 5 m

NEW

PREFIX

Für Strong Seitenmontage-Profile

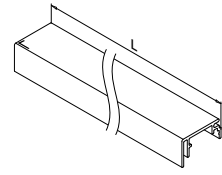
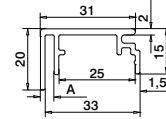

MOD 6977

Aluminium	Roh	A	
166977-003-50-00		3	L = 5 m
Aluminium	Gebürstet		
OUTDOOR			
166977-003-50-18		3	L = 5 m

NEW

PREFIX

Für Strong Seitenmontage-Profile

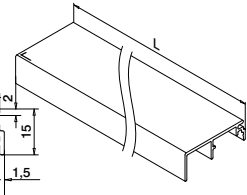
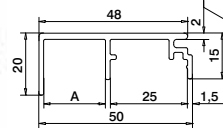

MOD 6977

Aluminium	Roh	A	
166977-020-50-00		20	L = 5 m
Aluminium	Gebürstet		
OUTDOOR			
166977-020-50-18		20	L = 5 m

NEW

PREFIX

Q-INFO MOD 6979

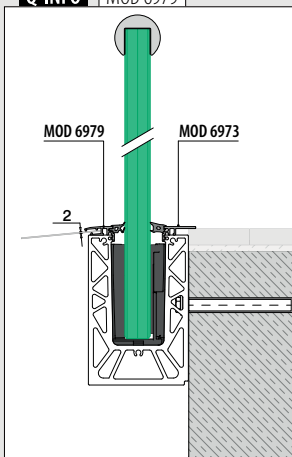

Q-INFO MOD 6975 / 6973

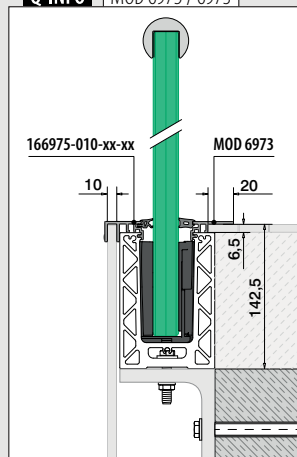

Q-INFO MOD 6977 / 6973

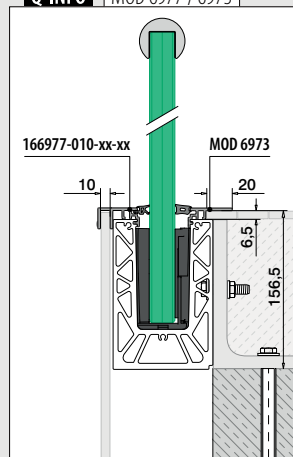



- Beanspruchung:** Leicht und mittel
Verwendung: Innen- und Aussenbereich
Montage: Boden-, In-Boden- und Seitenmontage
Anwendung: Balkone, Galerien, Wege, Abtrennungen und Treppen
Material: Aluminium (roh oder gebürstet anodisiert)
Glasstärke: 12 bis 21,52 mm

Finden Sie alle Informationen zu Easy Glass Slim online:



<https://q-ne.ws/Slim23>

EASY GLASS[®] SLIM

Hohe Transparenz, grosse Wirkung



Easy Glass® Slim ist der Klassiker in unserem Glasgeländer-Sortiment. Ganz gleich, ob es sich bei Ihrem Projekt um ein privates Wohnhaus, ein Büro oder einen öffentlichen Bereich handelt – dieses Glasgeländersystem ist immer eine kosteneffiziente Lösung. Sein minimalistisches Design umfasst ein schmales Bodenprofil, das für einen eleganten Look sorgt und dazu beiträgt, das Gesamtgewicht des Geländers niedrig zu halten.

Easy Glass® Slim	CH
Max. Holmlast (kN/m)	0.8



Bitte beachten Sie die Spezifikationen wie Befestigungs- und Glasmasse sowie Glastypen der jeweiligen Zertifikate.

International getestet/berechnet/zertifiziert:



- 1 Das bodenmontierte Slim Bodenprofil ist nur 45 mm breit, was es zu einer kosteneffizienten Lösung macht und zeitgleich für ein schlicht-elegantes Erscheinungsbild sorgt.
- 2 Das Bodenprofil ist leicht und einfach zu handhaben und daher ideal für das Manövrieren auf der Baustelle.

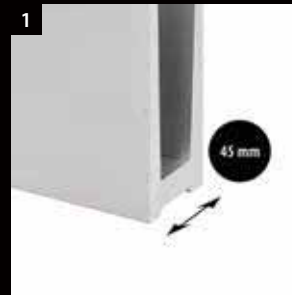

EASY GLASS® SLIM MONTAGEOPTIONEN

Slim Bodenmontage

- Auch für die In-Bodenmontage geeignet

97

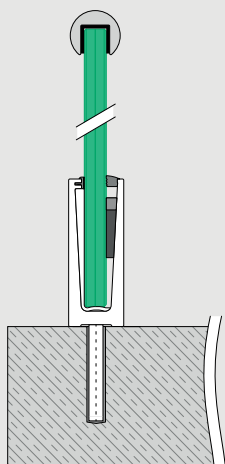

Slim F Bodenmontage

- Für Rohfussböden
- Kann direkt an der Bodenkante angebracht werden

99

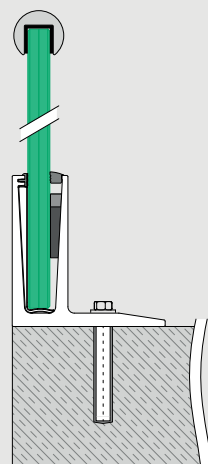

Slim Seitenmontage

- Optionale Bodenprofil-Blendeleiste

100

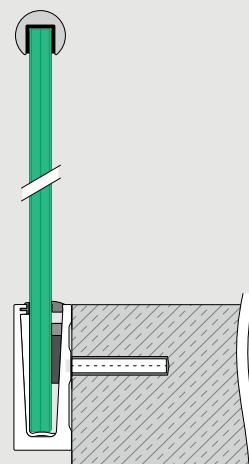

Geländerbasis

Safety Wedge System (Gummi- und Keilsets)

Glasklemmung (nicht justierbar)

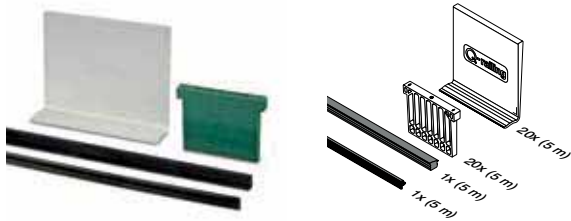

MOD 8000

Zubehör

Für monolithisches Glas		
	T	
208000-050-12	12	L = 5 m
208000-050-15	15	L = 5 m
208000-050-19	19	L = 5 m

Für laminiertes Glas

208000-050-13	12,76	L = 5 m
208000-050-14	13,52	L = 5 m
208000-050-17	16,76	L = 5 m
208000-050-18	17,52	L = 5 m
208000-050-21	20,76	L = 5 m
208000-050-22	21,52	L = 5 m

Zubehör

Easy Glass® Multitool



MOD 1001

Zubehör

	Q	
201001	Q-71	1

Geländerbasis

Trenngummi

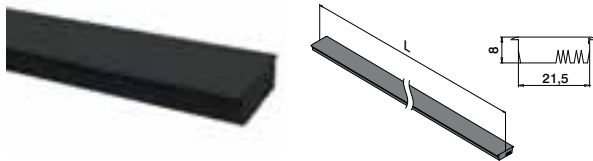

MOD 8105

Zubehör

	208105-025		L = 2,5 m
--	------------	--	-----------



Nur solange der Vorrat reicht.

Q-INFO MOD 8105

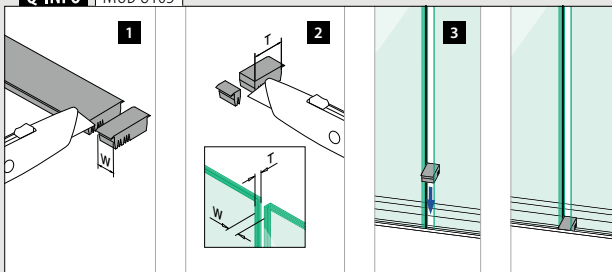

Q-INFO MOD 1001

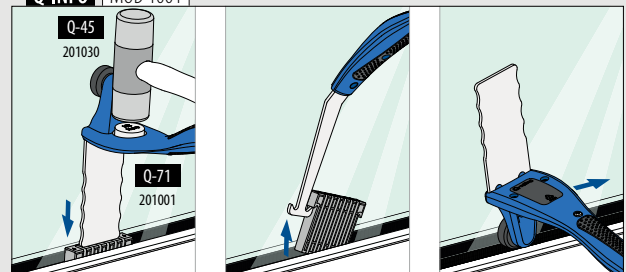

Bodenprofile zur Bodenmontage

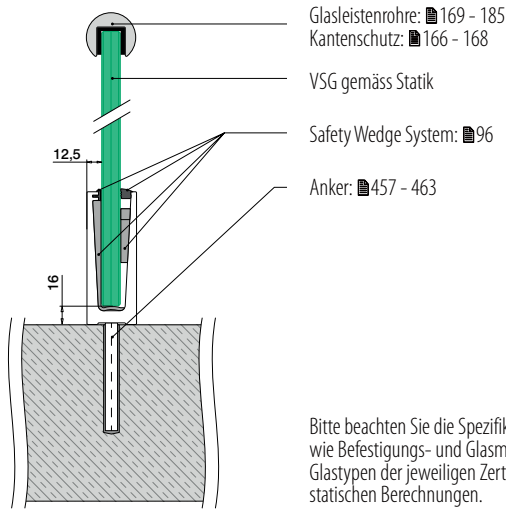

Bitte beachten Sie die Spezifikationen wie Befestigungs- und Glasmasse sowie Glastypen der jeweiligen Zertifikate und statischen Berechnungen.

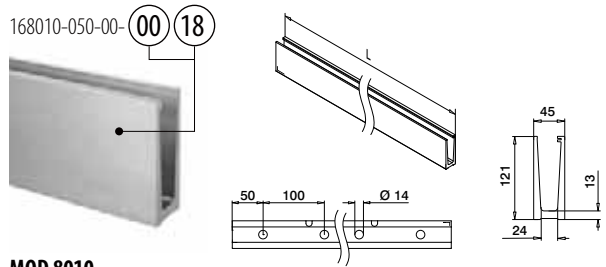

MOD 8010

Aluminium Roh

NEW 168010-050-00-00 457 - 463 L = 5 m

Aluminium Gebürstet

OUTDOOR

SELL OUT 168010-050-00-18 457 - 463 L = 5 m

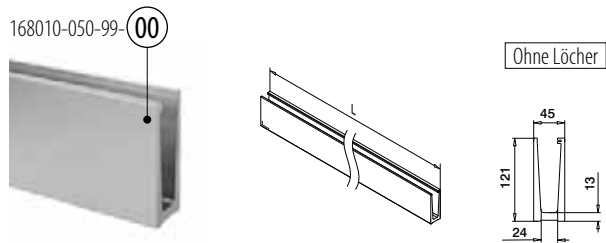

MOD 8010

Aluminium Roh

SELL OUT 168010-050-99-00 L = 5 m



Ecken zur Bodenmontage

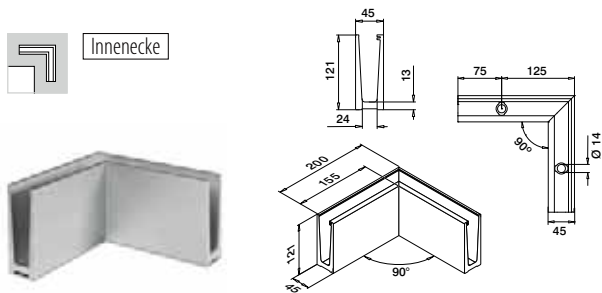

MOD 8011

Aluminium Gebürstet

OUTDOOR

SELL OUT 168011-01-18 457 - 463 1

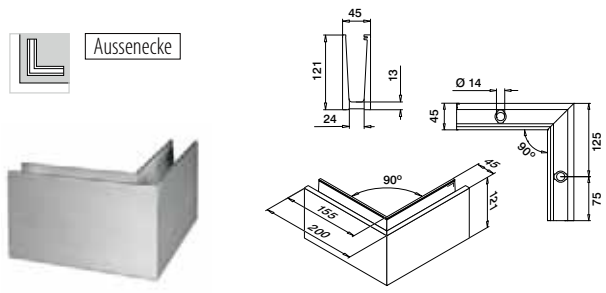

MOD 8011

Aluminium Gebürstet

OUTDOOR

SELL OUT 168011-02-18 457 - 463 1



Q-INFO MOD 8010

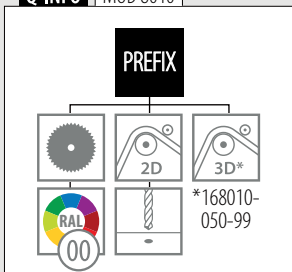

Q-INFO

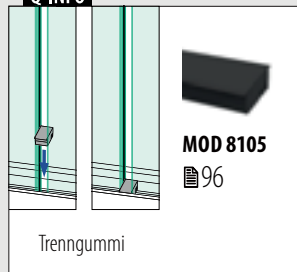

Q-INFO Aluminium



Geländerbasis

Endkappen zur Bodenmontage

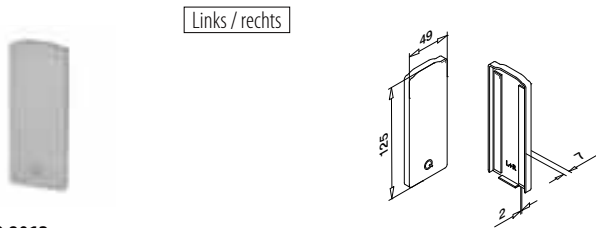

Links / rechts

MOD 8012

Aluminium Roh

Klebeband



SELL OUT	168012-00-00	Beigelegt	1
----------	--------------	-----------	---

Aluminium Gebürstet

OUTDOOR

SELL OUT	168012-00-18	Angebracht	1
----------	--------------	------------	---

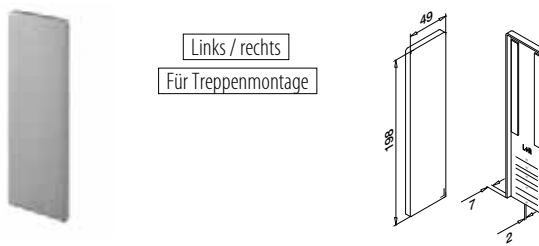

Links / rechts
Für Treppenmontage

MOD 8013

Aluminium Gebürstet

OUTDOOR

Klebeband



SELL OUT	168013-00-18	Angebracht	1
----------	--------------	------------	---



Geländerbasis

Drainageleisten zur Bodenmontage

Reicht für 2,5 m Bodenprofil

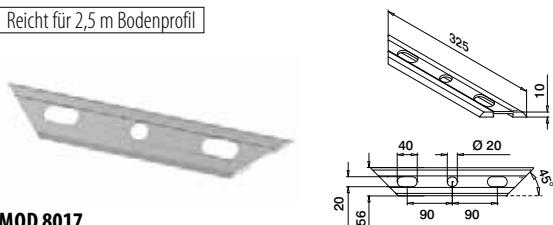

MOD 8017

Aluminium Gebürstet

OUTDOOR



SELL OUT	168017-18		8
----------	-----------	--	---

Internationaler Geschmacksmusterschutz

Q-INFO MOD 8017

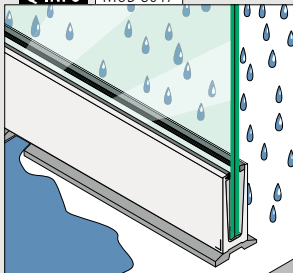

Montage-
informationen:



<https://q-ne.ws/Slim23>

Q-INFO Aluminium

00

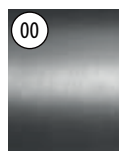

Roh

18



Gebürstet,
anodisiert

Q-INFO MOD 8012

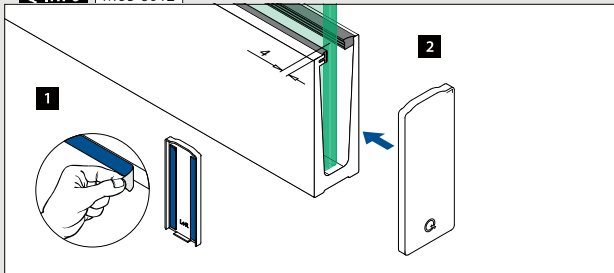

Q-INFO MOD 8013

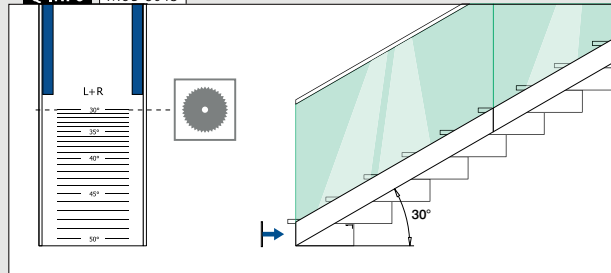

Bodenprofile zur Bodenmontage

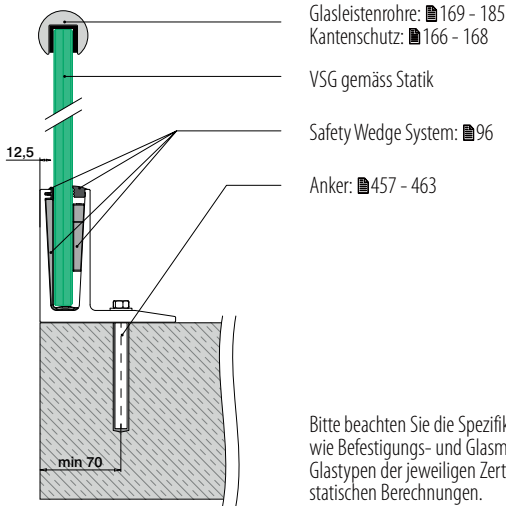

Bitte beachten Sie die Spezifikationen wie Befestigungs- und Glasmasse sowie Glasstypen der jeweiligen Zertifikate und statischen Berechnungen.

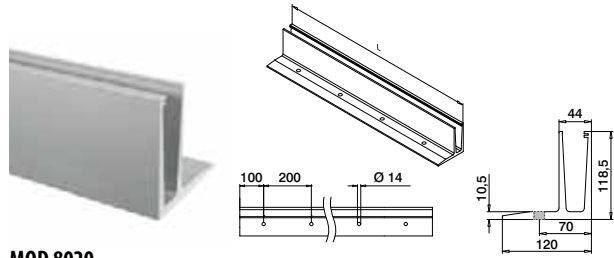

MOD 8020

Aluminium Gebürstet

OUTDOOR

SELL OUT 168020-050-00-18 457 - 463 L = 5 m

PREFIX



Ecken zur Bodenmontage

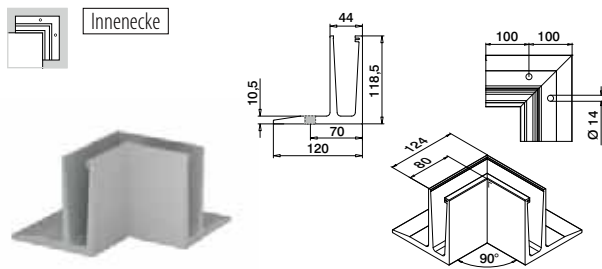

MOD 8021

Aluminium Gebürstet

OUTDOOR

SELL OUT 168021-01-18 457 - 463

1

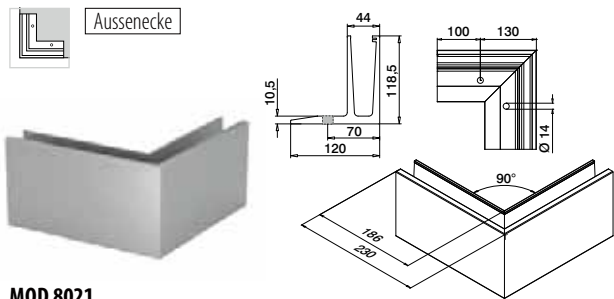

MOD 8021

Aluminium Gebürstet

OUTDOOR

SELL OUT 168021-02-18 457 - 463

1



Endkappen zur Bodenmontage

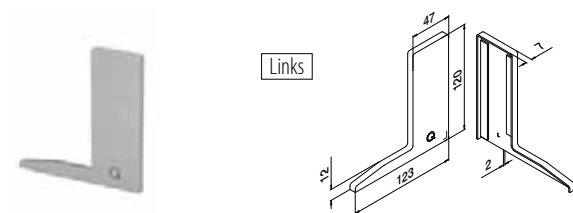

MOD 8022

Aluminium Gebürstet

OUTDOOR

Kleband

SELL OUT 168022-01-18 Angebracht

1

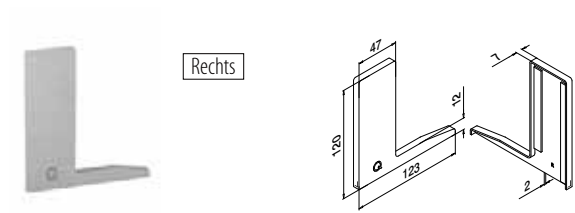

MOD 8022

Aluminium Gebürstet

OUTDOOR

Kleband

SELL OUT 168022-02-18 Angebracht

1

Q-INFO MOD 8020

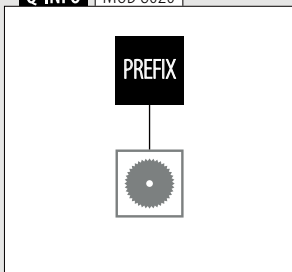

Q-INFO

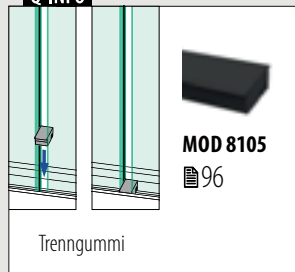

Q-INFO MOD 8022

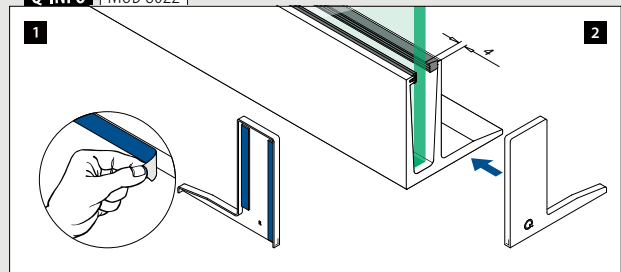

Geländerbasis

Bodenprofile zur Seitenmontage

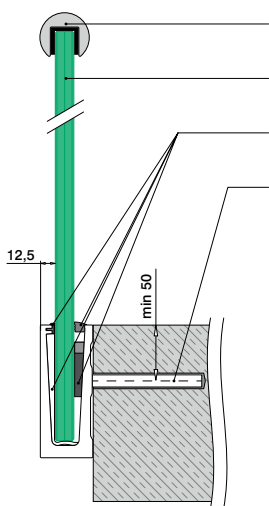

- Glasleistenrohre: ■ 169 - 185
- Kantenschutz: ■ 166 - 168
- VSG gemäss Statik
- Safety Wedge System: ■ 96
- Anker: ■ 457 - 463

Bitte beachten Sie die Spezifikationen wie Befestigungs- und Glasmasse sowie Glastypen der jeweiligen Zertifikate und statischen Berechnungen.

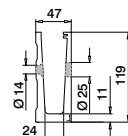
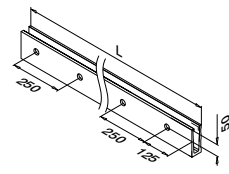

MOD 8030

Aluminium Gebürstet

OUTDOOR

SELL OUT	168030-050-00-18	■ 457 - 463	L = 5 m
----------	------------------	-------------	---------



Geländerbasis

Ecken zur Seitenmontage

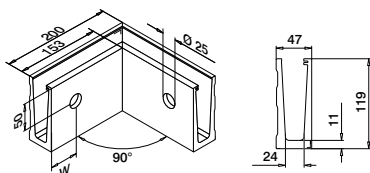
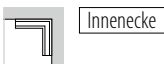

MOD 8031

Aluminium Gebürstet

OUTDOOR

W



SELL OUT	168031-01-18	100*	■ 457 - 463	1
----------	--------------	------	-------------	---

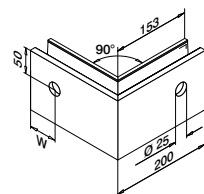

MOD 8031

Aluminium Gebürstet

OUTDOOR

W



SELL OUT	168031-02-18	100*	■ 457 - 463	1
----------	--------------	------	-------------	---



*Die Lochposition kann produktionsbedingt abweichen.

Q-INFO MOD 8030

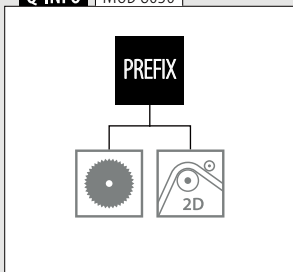

Q-INFO

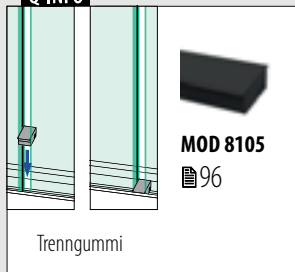

SELL OUT Nur solange der Vorrat reicht.

Endkappen zur Seitenmontage



Links
Verwendung bei Blendleiste

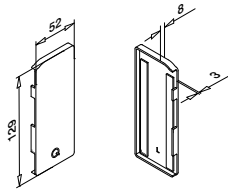

MOD 8034

Aluminium Gebürstet

OUTDOOR

Klebeband



SELL OUT	168034-01-18	Angebracht	1
----------	--------------	------------	---



Rechts
Verwendung bei Blendleiste

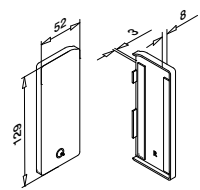

MOD 8034

Aluminium Gebürstet

OUTDOOR

Klebeband



SELL OUT	168034-02-18	Angebracht	1
----------	--------------	------------	---



Links
Verwendung ohne Blendleiste

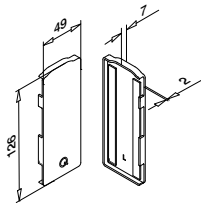

MOD 8032

Aluminium Gebürstet

OUTDOOR

Klebeband



SELL OUT	168032-01-18	Angebracht	1
----------	--------------	------------	---



Rechts
Verwendung ohne Blendleiste

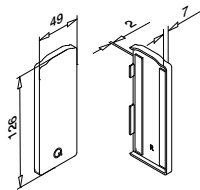

MOD 8032

Aluminium Gebürstet

OUTDOOR

Klebeband



SELL OUT	168032-02-18	Angebracht	1
----------	--------------	------------	---



Links
Verwendung mit
oder ohne Blendleiste
Für Treppenmontage

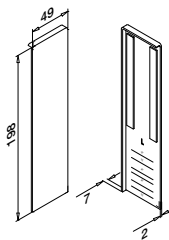

MOD 8033

Aluminium Gebürstet

OUTDOOR

Klebeband



SELL OUT	168033-01-18	Angebracht	1
----------	--------------	------------	---



Rechts
Verwendung mit
oder ohne Blendleiste
Für Treppenmontage

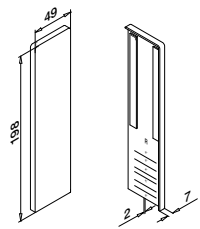

MOD 8033

Aluminium Gebürstet

OUTDOOR

Klebeband



SELL OUT	168033-02-18	Angebracht	1
----------	--------------	------------	---



Q-INFO MOD 8032 / 8034

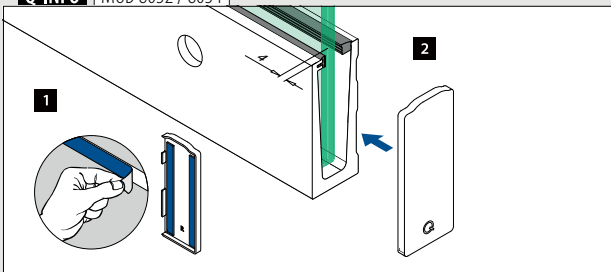

Q-INFO MOD 8033

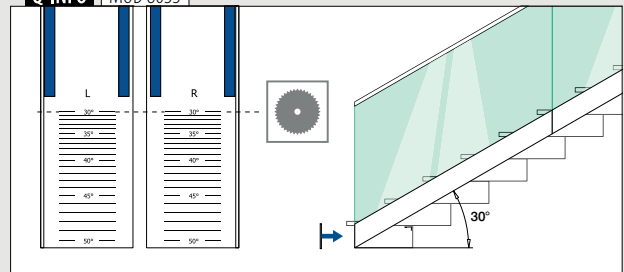

Geländerbasis

Blendleisten zur Seitenmontage



MOD 8035

Aluminium Gebürstet

OUTDOOR

Klebband



L = 2,5 m

SELL OUT

168035-025-18

Angebracht

Geländerbasis

Blendstopfen zur Seitenmontage

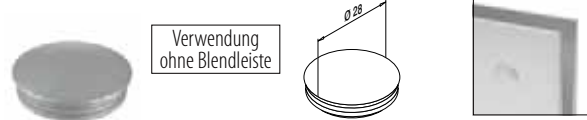

MOD 8038

Kunststoff Aluminium RAL 9006

INDOOR



SELL OUT

158038-36

10

SELL OUT Nur solange der Vorrat reicht.

Q-INFO MOD 8035

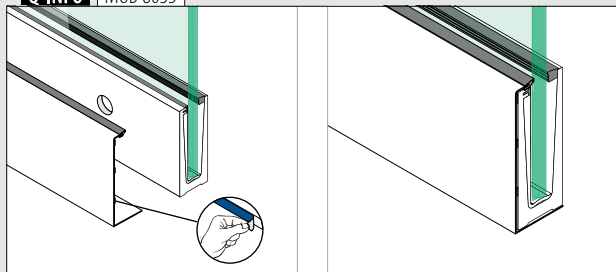

Q-INFO MOD 8038

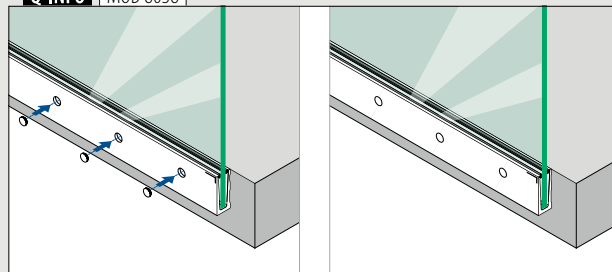





- Beanspruchung:** Leicht bis hoch
Verwendung: Innen- und Aussenbereich
Montage: Boden-, In-Boden- und Seitenmontage
Anwendung: Balkone, Galerien, Wege, Abtrennungen und Treppen
Material: Aluminium (roh oder gebürstet anodisiert)
Glasstärke: 12 bis 21,52 mm

Finden Sie alle Informationen zu Easy Glass Pro online:

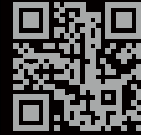

<https://q-ne.ws/Pro23>

EASY GLASS® PRO

Erledigen Sie alle notwendigen Arbeiten von der Innenseite des Geländers



Die Installation des Easy Glass® Pro Bodenprofils ist äusserst bequem. Auch die Justierung der Glasscheiben ist dank des einzigartigen Safety Wedge System mit Gummis und ausrichtbaren Keilen sehr einfach. Damit lässt sich die Glasfüllung bis zu 10 mm in der Vertikalen verstellen. Und mit vier verschiedenen Bodenprofilvarianten können Sie sicher sein, immer eine professionelle Lösung zu finden, die zu Ihrer spezifischen Montagesituation passt.

Easy Glass® Pro	CH
Max. Holmlast (kN/m)	1.6



Bitte beachten Sie die Spezifikationen wie Befestigungs- und Glasmasse sowie Glastypen der jeweiligen Zertifikate.

International getestet/berechnet/zertifiziert:



- 1 Wählen Sie aus vier verschiedenen Bodenprofilen, um allen Projektanforderungen gerecht zu werden. Pro meistert selbst anspruchsvollste Bausituationen.
- 2 Richten Sie das Glas um bis zu 10 mm (1°) in der Vertikalen aus – und das von der Innenseite des Geländers.

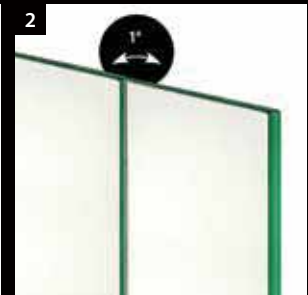

EASY GLASS® PRO MONTAGEOPTIONEN

Pro Bodenmontage

- Auch für die In-Bodenmontage geeignet

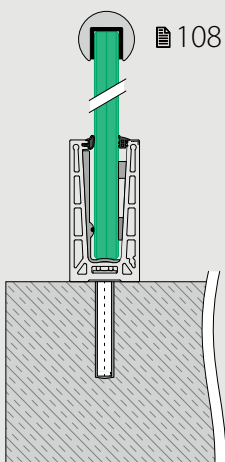

Pro F Bodenmontage

- Für Rohfussböden
- Kann direkt an oder über der Bodenkante angebracht werden

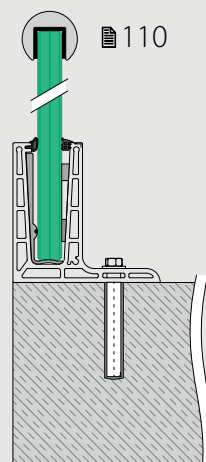

Pro Seitenmontage

- Optionale Bodenprofil-Blende
- Kann direkt an oder über der Bodenkante angebracht werden

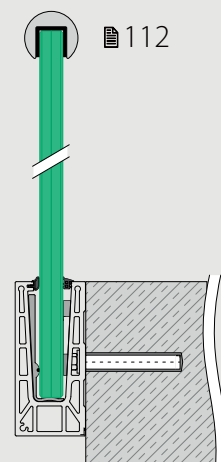

Pro Y Seitenmontage

- Für Rohfussböden
- Kann direkt an oder über der Bodenkante angebracht werden
- Optionale Bodenprofil-Blende

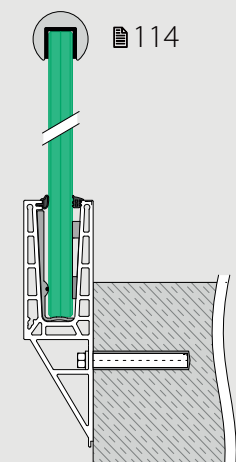

Geländerbasis

Safety Wedge System (Gummi- und Keilsets)

Glasklemmung und -justierung

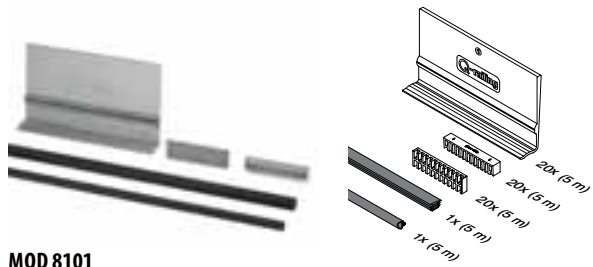

MOD 8101

Zubehör

Für monolithisches Glas		
SELL OUT	T	
208101-050-12	12	L = 5 m
208101-050-15	15	L = 5 m
208101-050-19	19	L = 5 m

Für laminiertes Glas

SELL OUT		
208101-050-13	12,76	L = 5 m
208101-050-14	13,52	L = 5 m
208101-050-17	16,76	L = 5 m
208101-050-18	17,52	L = 5 m
208101-050-21	20,76	L = 5 m
208101-050-22	21,52	L = 5 m

Internationaler Geschmacksmusterschutz

Zubehör

Easy Glass® Multitool



MOD 1001

Zubehör

	Q	
201001	Q-71	1

Q-INFO | MOD 8101

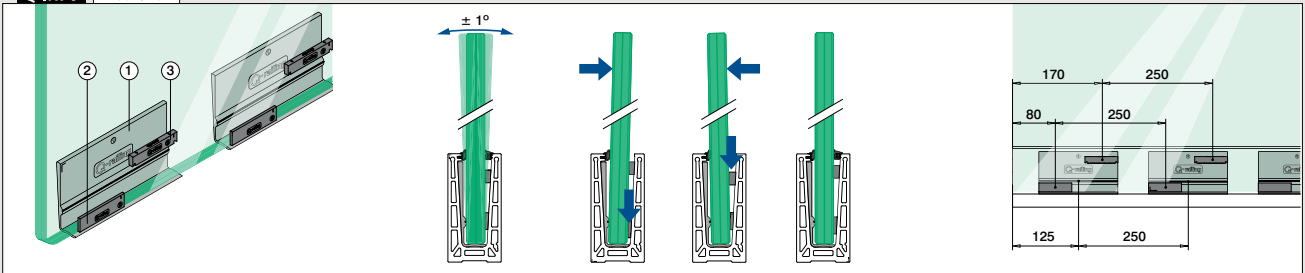

Geländerbasis

Safety Wedge System (Gummi- und Keilsets)

Glasklemmung (nicht justierbar)

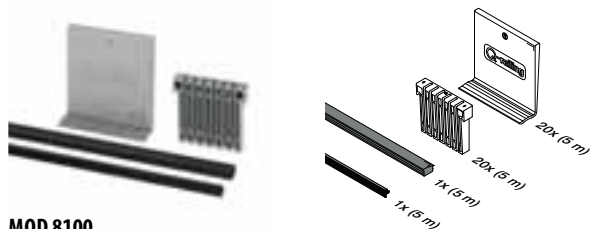

MOD 8100

Zubehör

Für monolithisches Glas		
SELL OUT	T	
208100-050-12	12	L = 5 m
208100-050-15	15	L = 5 m
208100-050-19	19	L = 5 m

Für laminiertes Glas

SELL OUT		
208100-050-13	12,76	L = 5 m
208100-050-14	13,52	L = 5 m
208100-050-17	16,76	L = 5 m
208100-050-18	17,52	L = 5 m
208100-050-21	20,76	L = 5 m
208100-050-22	21,52	L = 5 m

Internationaler Geschmacksmusterschutz

Zubehör

Easy Glass® Multitool



MOD 1001

Zubehör

	Q	
201001	Q-71	1

Q-INFO | MOD 8100

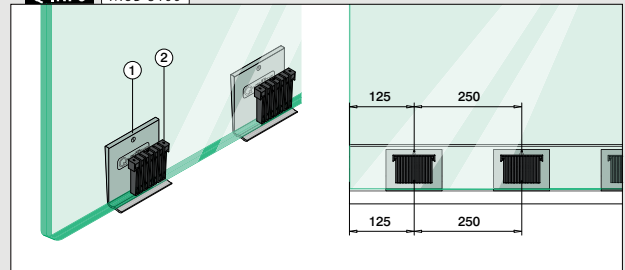

Safety Wedge System (Gummi- und Keilsets)

Glasklemmung und -justierung **Easy Glass® Pro F**

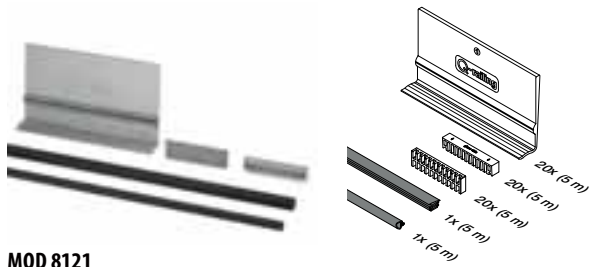

MOD 8121

Zubehör

Für monolithisches Glas		
	T	
208121-050-12	12	L = 5 m
208121-050-15	15	L = 5 m
208121-050-19	19	L = 5 m

Für laminiertes Glas

SELL OUT	208121-050-13	12,76	L = 5 m
SELL OUT	208121-050-14	13,52	L = 5 m
SELL OUT	208121-050-17	16,76	L = 5 m
SELL OUT	208121-050-18	17,52	L = 5 m
SELL OUT	208121-050-21	20,76	L = 5 m
SELL OUT	208121-050-22	21,52	L = 5 m

Internationaler Geschmacksmusterschutz

Easy Glass® Multitool



MOD 1001

Zubehör

	Q	
201001	Q-71	1

Q-INFO MOD 8121

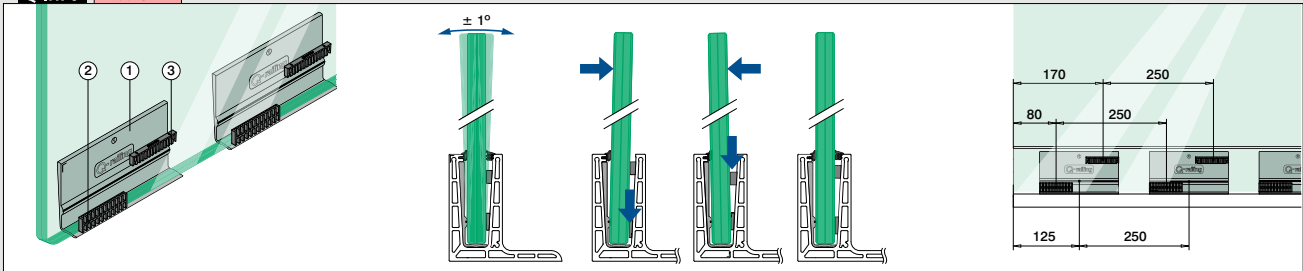

Verbindungsstifte

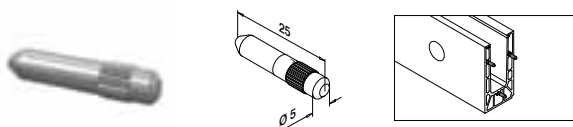

MOD 3005

V4A	316	Roh
OUTDOOR		
143005		6



SELL OUT Nur solange der Vorrat reicht.

Trenngummi

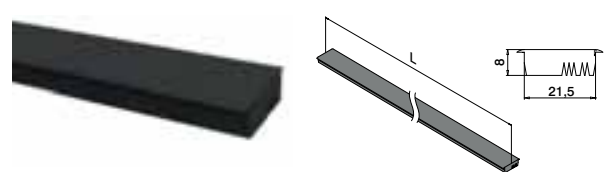

MOD 8105

Zubehör

SELL OUT	208105-025	L = 2,5 m
-----------------	------------	-----------



Q-INFO MOD 1001

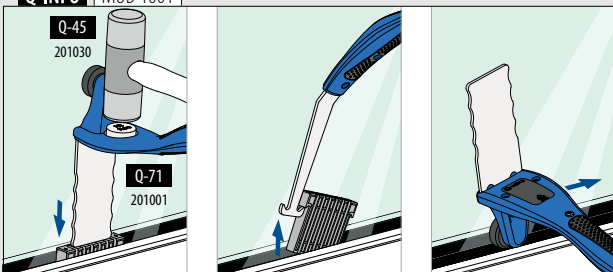

Q-INFO MOD 8105

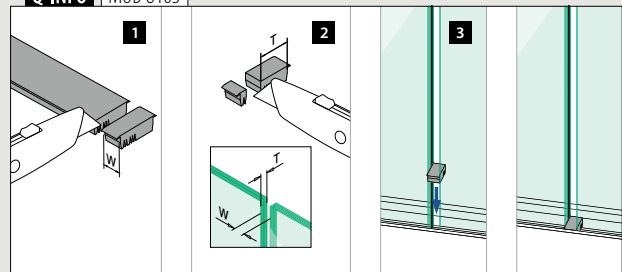

Bodenprofile zur Bodenmontage

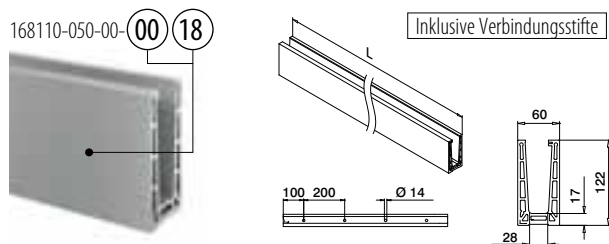
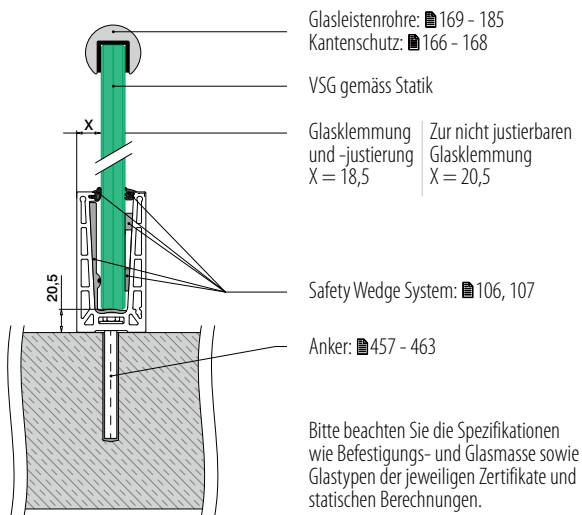

MOD 8110

Aluminium Roh

SELL OUT 168110-050-00-00 ■ 457 - 463 L = 5 m

Aluminium Gebürstet

OUTDOOR

SELL OUT 168110-050-00-18 ■ 457 - 463 L = 5 m



Internationaler Geschmacksmusterschutz

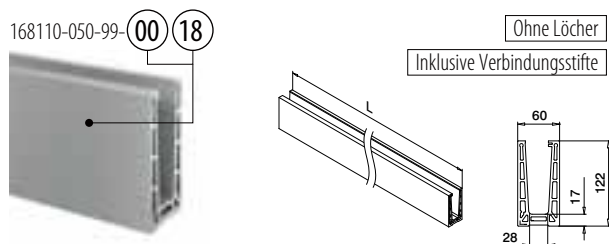

MOD 8110

Aluminium Roh

SELL OUT 168110-050-99-00 L = 5 m

Aluminium Gebürstet

OUTDOOR

SELL OUT 168110-050-99-18 L = 5 m



Internationaler Geschmacksmusterschutz

SELL OUT Nur solange der Vorrat reicht.

Q-INFO

PREFIX

Q-INFO

MOD 8105
■ 107

Trenngummi

Q-INFO **Aluminium**

00

Roh

18

Gebürstet, anodisiert

Q-INFO

MOD 3005
■ 107

Zusätzliche Verbindungsstifte

Ecken zur Bodenmontage

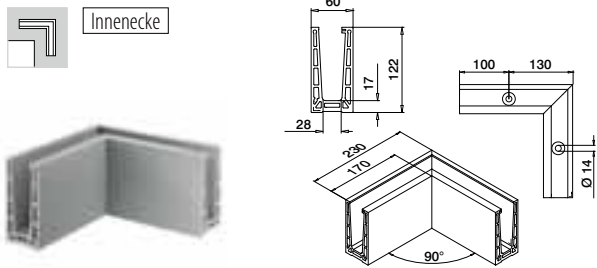

MOD 8111

Aluminium Gebürstet
OUTDOOR

SELL OUT	168111-01-18	457 - 463	1
----------	--------------	-----------	---

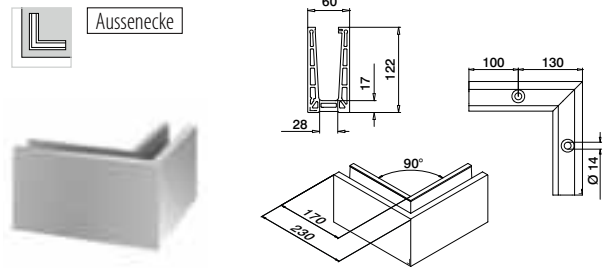

MOD 8111

Aluminium Gebürstet
OUTDOOR

SELL OUT	168111-02-18	457 - 463	1
----------	--------------	-----------	---



Endkappen zur Bodenmontage

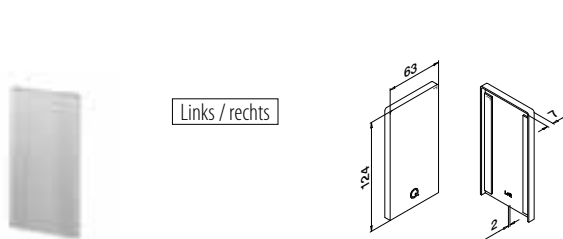

MOD 8112

Aluminium Roh
Klebeband

SELL OUT	168112-00-00	Beigelegt	1
----------	--------------	-----------	---

Aluminium Gebürstet
OUTDOOR

SELL OUT	168112-00-18	Angebracht	1
----------	--------------	------------	---

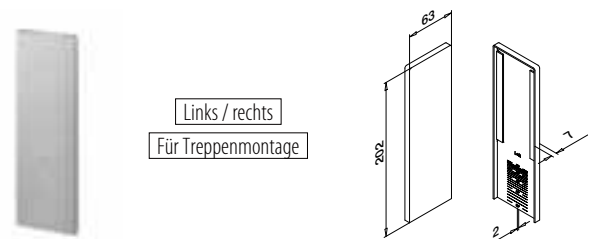

MOD 8113

Aluminium Gebürstet
OUTDOOR Klebeband

SELL OUT	168113-00-18	Angebracht	1
----------	--------------	------------	---



Drainageleisten zur Bodenmontage

8 Stück für 5-Meter-Bodenprofil

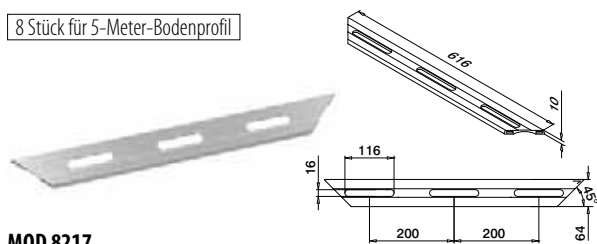

MOD 8217

Aluminium Gebürstet
OUTDOOR

168217-18	4
-----------	---

Q-INFO MOD 8217

Montage-
informationen:

[https://q-ne.ws/
Pro23](https://q-ne.ws/Pro23)

Q-INFO MOD 8112

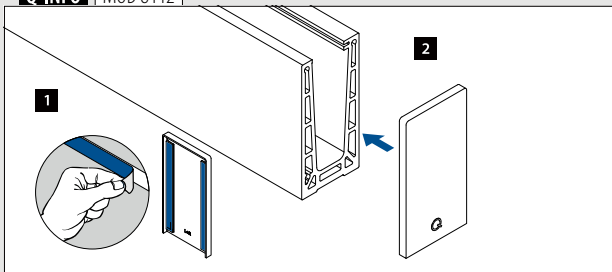

Q-INFO MOD 8113

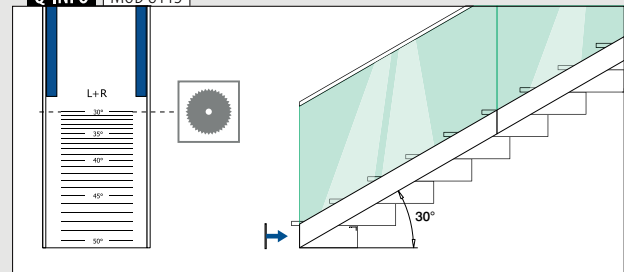

Geländerbasis

Bodenprofile zur Bodenmontage

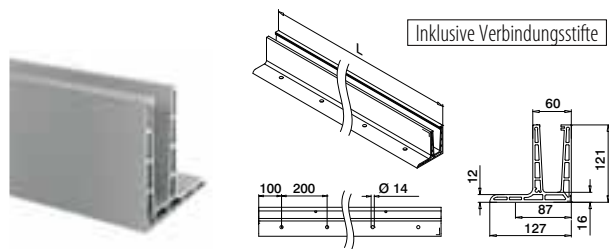
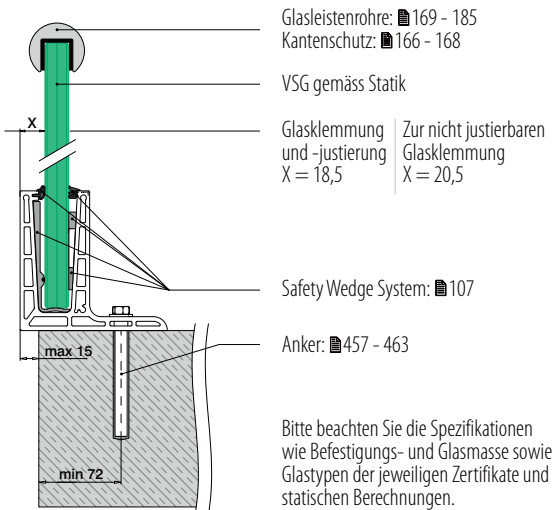

MOD 8120

Aluminium Gebürstet

OUTDOOR

SELL OUT 168120-050-00-18 ■ 457 - 463 L = 5 m



Internationaler Geschmacksmusterschutz

Geländerbasis

Ecken zur Bodenmontage

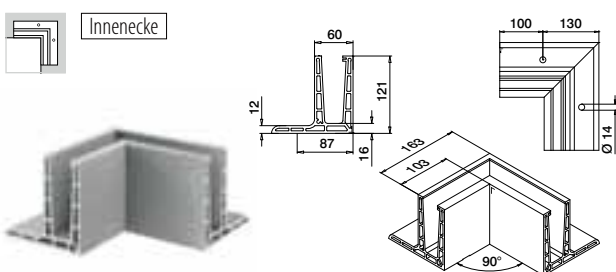

MOD 8121

Aluminium Gebürstet

OUTDOOR

SELL OUT 168121-01-18 ■ 457 - 463 1

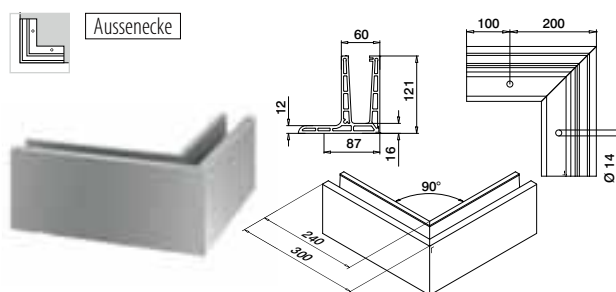

MOD 8121

Aluminium Gebürstet

OUTDOOR

SELL OUT 168121-02-18 ■ 457 - 463 1



Geländerbasis

Endkappen zur Bodenmontage

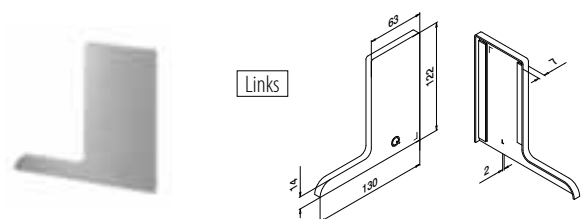

MOD 8122

Aluminium Gebürstet

OUTDOOR

Klebeband

SELL OUT 168122-01-18 Angebracht 1

SELL OUT Nur solange der Vorrat reicht.

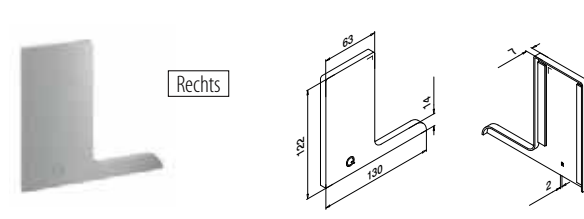

MOD 8122

Aluminium Gebürstet

OUTDOOR

Klebeband

SELL OUT 168122-02-18 Angebracht 1

Q-INFO MOD 8120

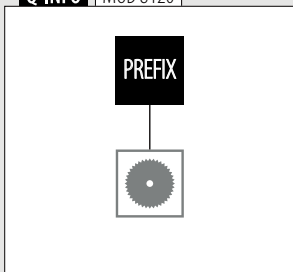

Q-INFO MOD 8120

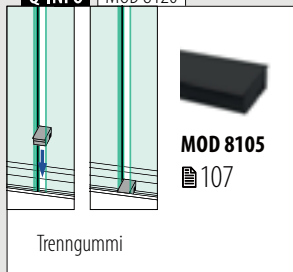

Q-INFO MOD 8122

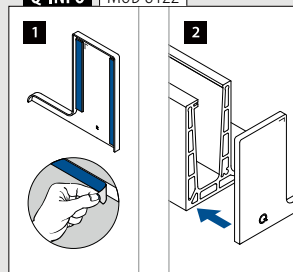

Q-INFO MOD 8120 / 8121





Geländerbasis

Bodenprofile zur Seitenmontage

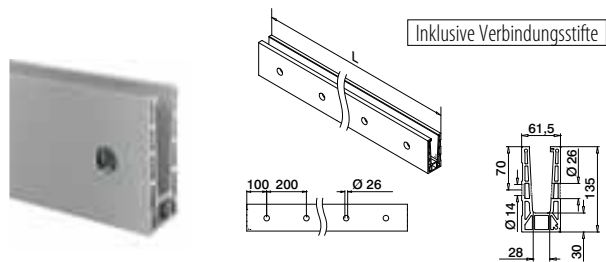
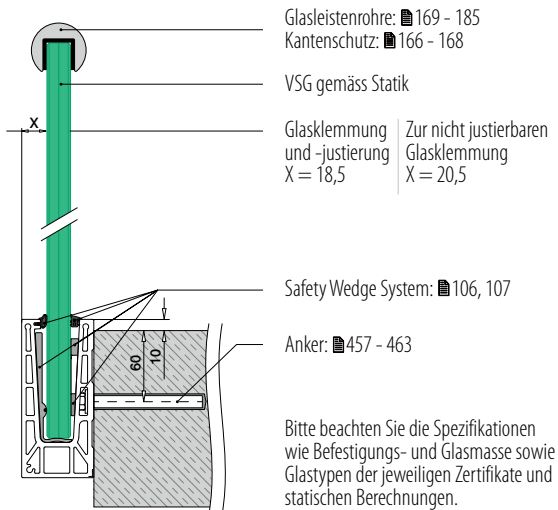

MOD 8130

Aluminium Gebürstet

OUTDOOR

SELL OUT 168130-050-00-18 ■ 457 - 463 L = 5 m



Internationaler Geschmacksmusterschutz

Geländerbasis

Ecken zur Seitenmontage

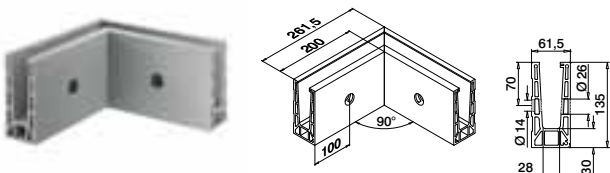
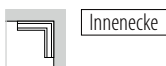

MOD 8131

Aluminium Gebürstet

OUTDOOR

SELL OUT 168131-01-18 ■ 457 - 463 1

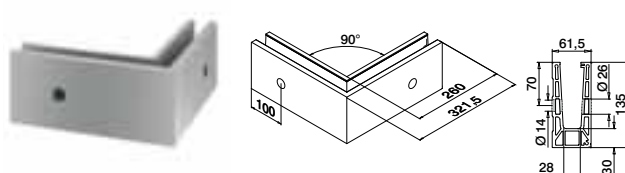

MOD 8131

Aluminium Gebürstet

OUTDOOR

SELL OUT 168131-02-18 ■ 457 - 463 1

Geländerbasis

Drainageleisten zur Seitenmontage

8 Stück für 5-Meter-Bodenprofil

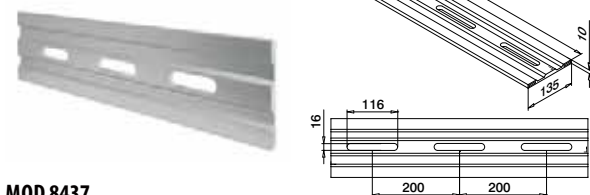

MOD 8437

Aluminium Gebürstet

OUTDOOR

SELL OUT 168437-18 4

Q-INFO MOD 8130 / 8131

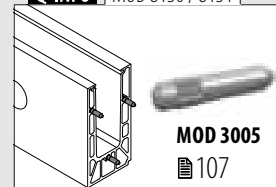

Zusätzliche Verbindungsstifte

Q-INFO MOD 8130

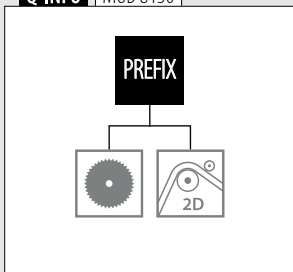

Q-INFO MOD 8130

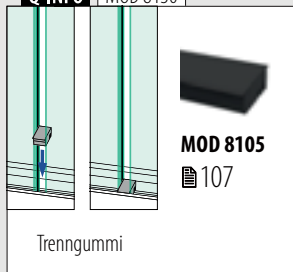

Q-INFO MOD 8437

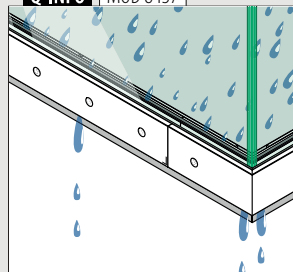

Montageinformationen:



<https://q-ne.ws/Pro23>

Endkappen zur Seitenmontage

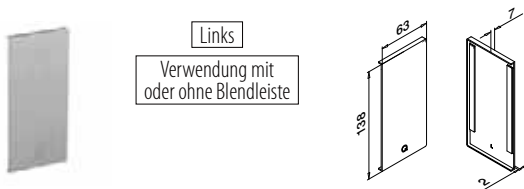

Links
Verwendung mit
oder ohne Blindleiste

MOD 8132

Aluminium	Gebürstet	
OUTDOOR	Klebeband	
SELL OUT 168132-01-18	Angebracht	1

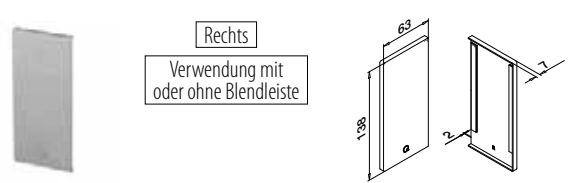

Rechts
Verwendung mit
oder ohne Blindleiste

MOD 8132

Aluminium	Gebürstet	
OUTDOOR	Klebeband	
SELL OUT 168132-02-18	Angebracht	1

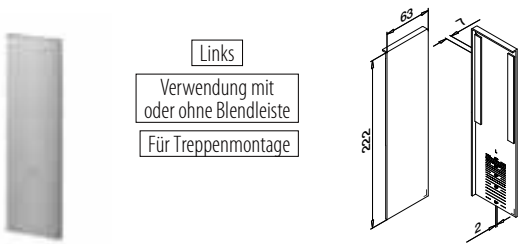

Links
Verwendung mit
oder ohne Blindleiste
Für Treppensmontage

MOD 8133

Aluminium	Gebürstet	
OUTDOOR	Klebeband	
SELL OUT 168133-01-18	Angebracht	1

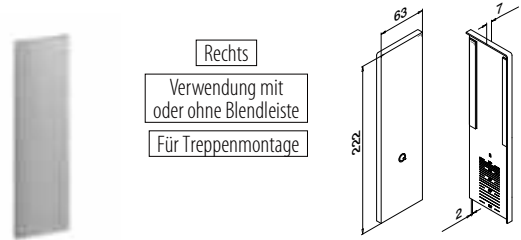

Rechts
Verwendung mit
oder ohne Blindleiste
Für Treppensmontage

MOD 8133

Aluminium	Gebürstet	
OUTDOOR	Klebeband	
SELL OUT 168133-02-18	Angebracht	1



Blendleisten zur Seitenmontage



Blendleiste Vorderseite

MOD 8135

Aluminium	Gebürstet	
OUTDOOR	Klebeband	
SELL OUT 168135-050-18	Angebracht	L = 5 m



Blendstopfen zur Seitenmontage

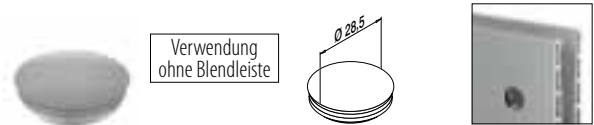

Verwendung
ohne Blindleiste

MOD 8138

Kunststoff	Aluminium RAL 9006	
INDOOR	Klebeband	
SELL OUT 158138-36	Angebracht	10

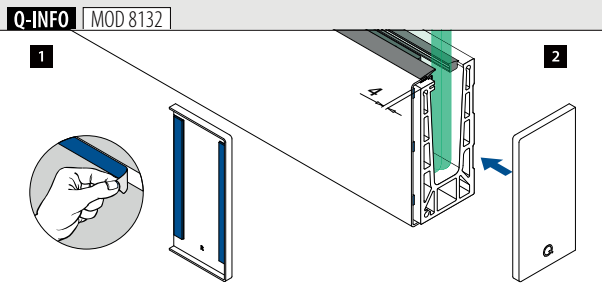
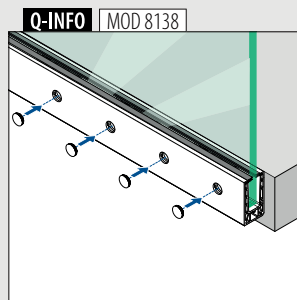
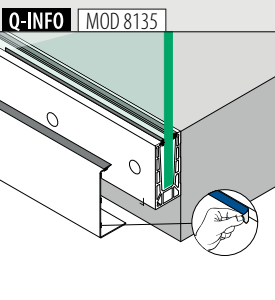

SELL OUT Nur solange der Vorrat reicht.

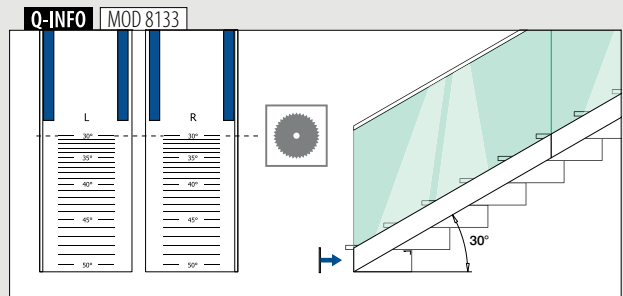

Bodenprofile zur Seitenmontage

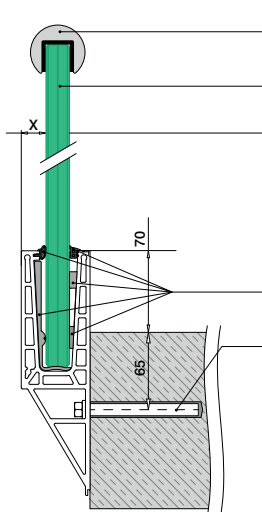

- Glasleistenrohre: ■ 169 - 185
- Kantenschutz: ■ 166 - 168
- VSG gemäss Statik
- Glasklemmung und -justierung X = 18,5
- Zur nicht justierbaren Glasklemmung X = 20,5
- Safety Wedge System: ■ 106, 107
- Anker: ■ 457 - 463

Bitte beachten Sie die Spezifikationen wie Befestigungs- und Glasmasse sowie Glastypeen der jeweiligen Zertifikate und statischen Berechnungen.

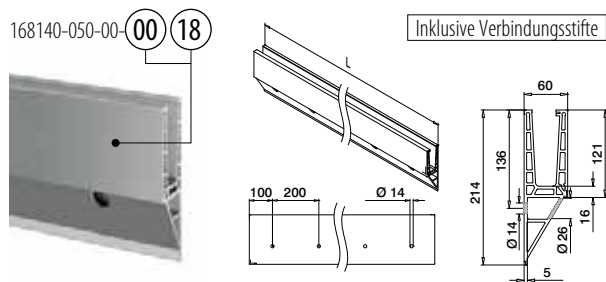

MOD 8140

Aluminium Roh

SELL OUT	168140-050-00-00	■ 457 - 463	L = 5 m
----------	------------------	-------------	---------

Aluminium Gebürstet

OUTDOOR

SELL OUT	168140-050-00-18	■ 457 - 463	L = 5 m
----------	------------------	-------------	---------



Internationaler Geschmacksmusterschutz

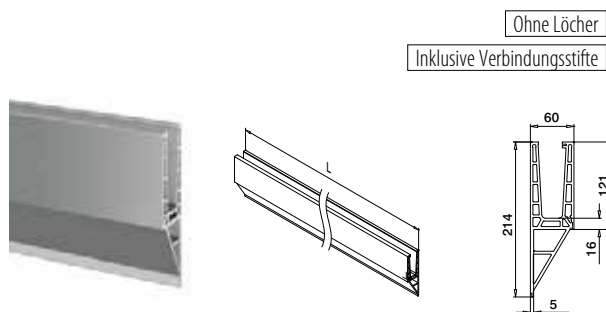

MOD 8140

Aluminium Gebürstet

OUTDOOR

SELL OUT	168140-050-99-18	L = 5 m
----------	------------------	---------



Internationaler Geschmacksmusterschutz

SELL OUT Nur solange der Vorrat reicht.

Q-INFO

PREFIX

Q-INFO

MOD 8105
■ 107

Trenngummi

Q-INFO Aluminium

00

Roh

18

Gebürstet, anodisiert

Q-INFO

MOD 3005
■ 107

Zusätzliche Verbindungsstifte

Ecken zur Seitenmontage

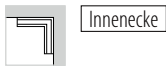

Innenecke

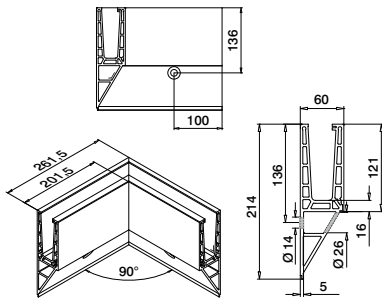

MOD 8141

Aluminium Gebürstet
OUTDOOR

SELL OUT	168141-01-18	457 - 463	1
----------	--------------	-----------	---



Aussenecke

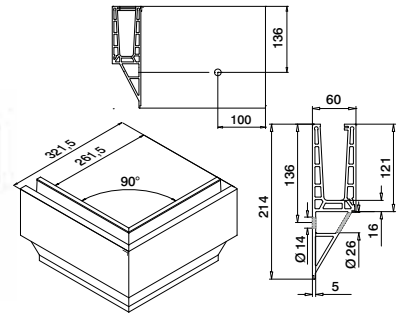

MOD 8141

Aluminium Gebürstet
OUTDOOR



SELL OUT	168141-02-18	457 - 463	1
----------	--------------	-----------	---



Endkappen zur Seitenmontage

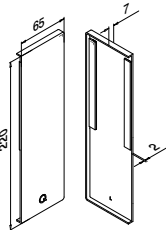

Links

Verwendung mit
oder ohne Blendleiste

MOD 8142

Aluminium Gebürstet
OUTDOOR
Klebeband

SELL OUT	168142-01-18	Angebracht	1
----------	--------------	------------	---

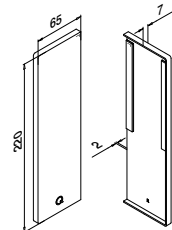

Rechts

Verwendung mit
oder ohne Blendleiste

MOD 8142

Aluminium Gebürstet
OUTDOOR
Klebeband

SELL OUT	168142-02-18	Angebracht	1
----------	--------------	------------	---

Blendleisten zur Seitenmontage



Blendleiste Vorderseite

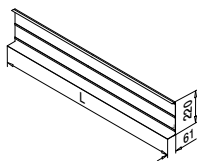

MOD 8145

Aluminium Gebürstet
OUTDOOR
Klebeband

SELL OUT	168145-050-18	Angebracht	L = 5 m
----------	---------------	------------	---------



Q-INFO MOD 8142

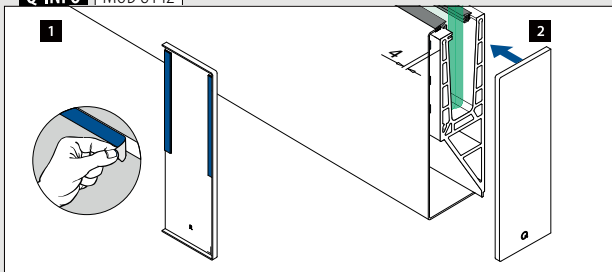

Q-INFO MOD 8145

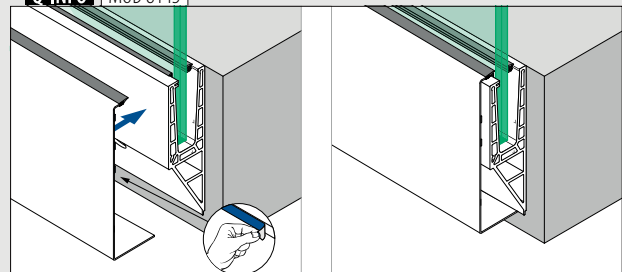



Beanspruchung: Hoch und besonders hoch
Verwendung: Innen- und Aussenbereich
Montage: Boden-, In-Boden- und Seitenmontage
Anwendung: Balkone, Galerien, Wege, Abtrennungen und Treppen
Material: Aluminium (gebürstet anodisiert und roh)
Glasstärke: 19 bis 31,52 mm

Finden Sie alle Informationen zu Easy Glass Max online:



<https://q-ne.ws/Max23>

EASY GLASS[®] MAX

Ausserordentlich robust und sicher



Das elegante Kraftpaket hält extremen Belastungen und hohen Windlasten stand. Seine ausgezeichnete Kombination von Eigenschaften macht Max zur perfekten Wahl für öffentliche Einrichtungen mit hohen Sicherheitsanforderungen, darunter Stadien, Flughäfen und Einkaufszentren.

Easy Glass® Max	CH
Max. Holmlast (kN/m)	3,0



Bitte beachten Sie die Spezifikationen wie Befestigungs- und Glasmasse der jeweiligen Zertifikate.

International getestet/berechnet/zertifiziert:



- 1 Perfekt für öffentliche Einrichtungen mit hohen Sicherheitsanforderungen, wie Stadien.
- 2 Montage direkt auf Beton, ohne dass eine Stahlkonstruktion erforderlich ist.



EASY GLASS® MAX MONTAGEOPTIONEN

Max Bodenmontage

- Auch für In-Bodenmontage geeignet

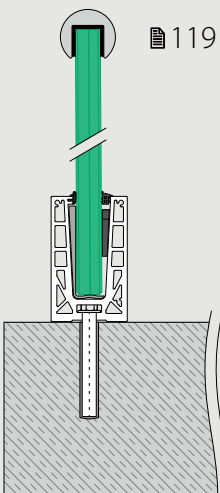

Max F Bodenmontage

- Für Rohfussböden
- Kann direkt an oder über der Bodenkante angebracht werden

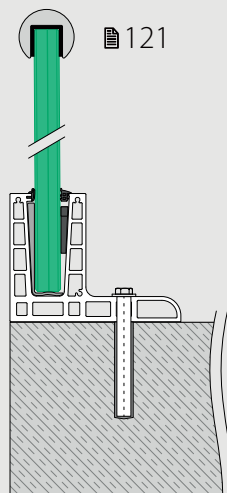

Max Seitenmontage

- Bodenprofil-Blendleiste erhältlich

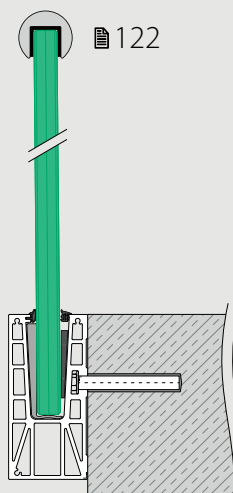

Max Y Seitenmontage

- Für Rohfussböden
- Kann direkt an oder über der Bodenkante angebracht werden
- Optionale Bodenprofil-Blendleiste

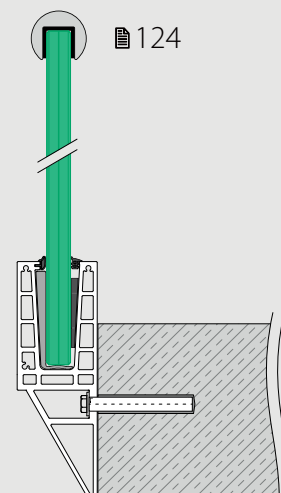

Geländerbasis

Safety Wedge System (Gummi- und Keilsets)

Glasklemmung (nicht justierbar)

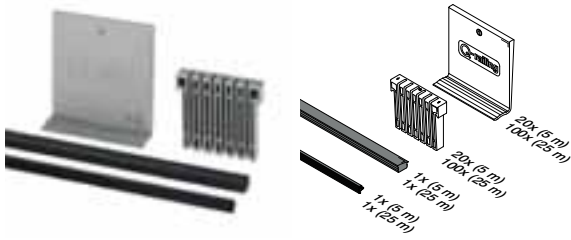

MOD 8500

Zubehör		
Für monolithisches Glas		
208500-050-19	19	L = 5 m
208500-050-25	25	L = 5 m
Für laminiertes Glas		
208500-050-21	20,76	L = 5 m
208500-050-22	21,52	L = 5 m
208500-050-24	24,76	L = 5 m
208500-050-26	25,52	L = 5 m
208500-050-32	31,52	L = 5 m
Für monolithisches Glas		
208500-250-19	19	L = 25 m
Für laminiertes Glas		
208500-250-21	20,76	L = 25 m
208500-250-22	21,52	L = 25 m
208500-250-24	24,76	L = 25 m
208500-250-26	25,52	L = 25 m
208500-250-32	31,52	L = 25 m

Internationaler Geschmacksmusterschutz

Zubehör

Easy Glass® Multitool



MOD 1001

Zubehör		
201001	Q-71	1

Q-INFO MOD 8500

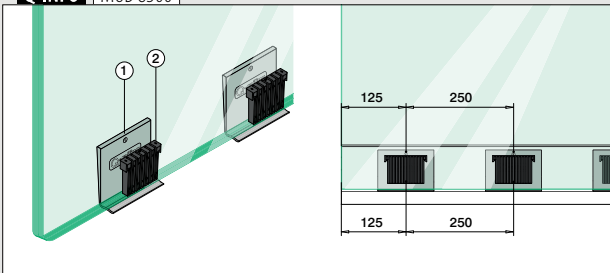

Q-INFO MOD 1001

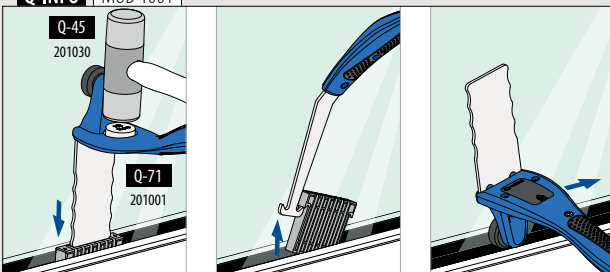

Zubehör

Einzelne Gummis



MOD 8506

Zubehör		
208506-250-00		L = 25 m

NEW



MOD 8506

Zubehör		
Für monolithisches Glas		
208506-250-19	19	L = 25 m
Für laminiertes Glas		
208506-250-22	20,76 - 21,52	L = 25 m
208506-250-26	24,76 - 25,52	L = 25 m
208506-250-32	31,52	L = 25 m

NEW

Geländerbasis

Trenngummi

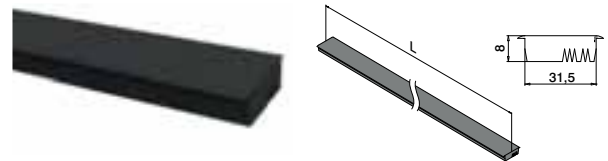

MOD 8505

Zubehör		
208505-025		L = 2,5 m



Q-INFO MOD 8505

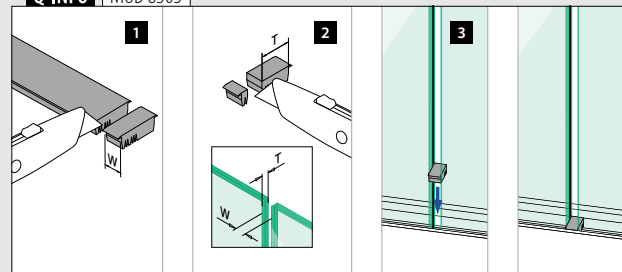

Bodenprofile zur Bodenmontage

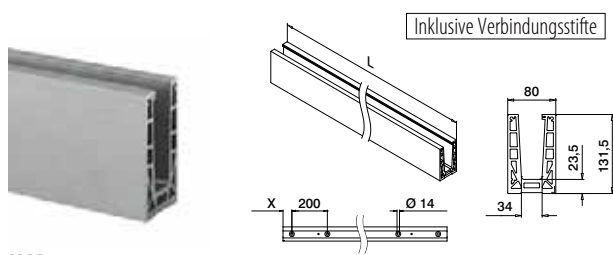
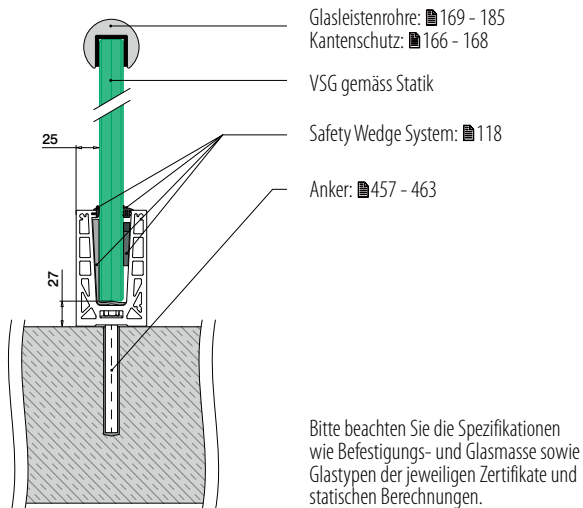

MOD 8510

Aluminium Roh		X		
NEW	168510-025-00-00	50	457 - 463	L = 2,5 m
NEW	168510-050-00-00	100	457 - 463	L = 5 m
Aluminium Gebürstet		OUTDOOR		
	168510-025-00-18	50	457 - 463	L = 2,5 m
NEW	168510-050-00-18	100	457 - 463	L = 5 m



Internationaler Geschmacksmusterschutz

Ecken zur Bodenmontage

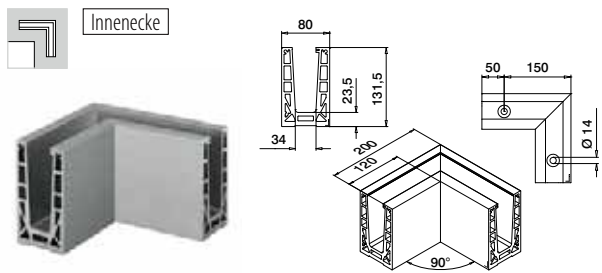

MOD 8511

Aluminium Gebürstet		OUTDOOR		
	168511-01-18	1	457 - 463	

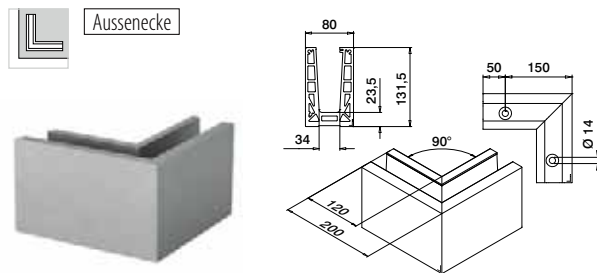

MOD 8511

Aluminium Gebürstet		OUTDOOR		
	168511-02-18	1	457 - 463	



Verbindungsstifte

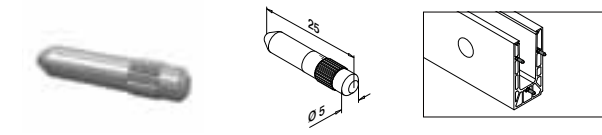

MOD 3005

V4A	316 Roh	
	143005	6



Q-INFO MOD 8510

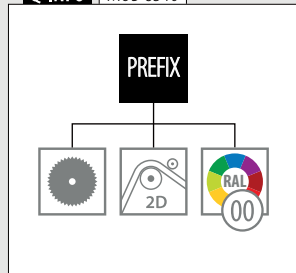

Q-INFO MOD 8510

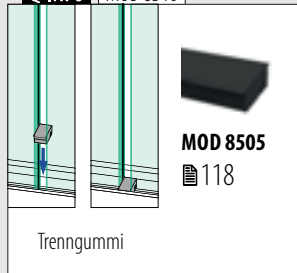

Q-INFO Aluminium



Geländerbasis

Endkappen zur Bodenmontage

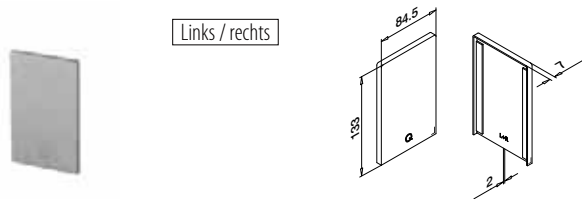

MOD 8512

Aluminium	Gebürstet		
OUTDOOR	Klebeband		
168512-00-18	Angebracht	1	

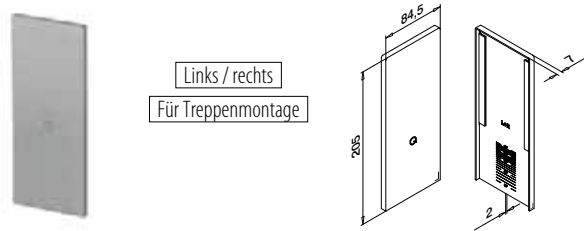

MOD 8513

Aluminium	Gebürstet		
OUTDOOR	Klebeband		
168513-00-18	Angebracht	1	



Geländerbasis

Unterlegscheiben zur Bodenmontage

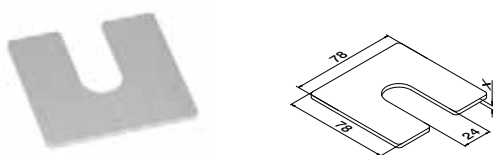

MOD 8516

Aluminium	Roh		
	X		
168516-001	1	100	
168516-002	2	100	
168516-003	3	100	

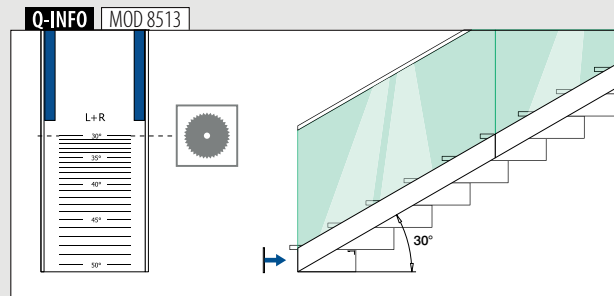
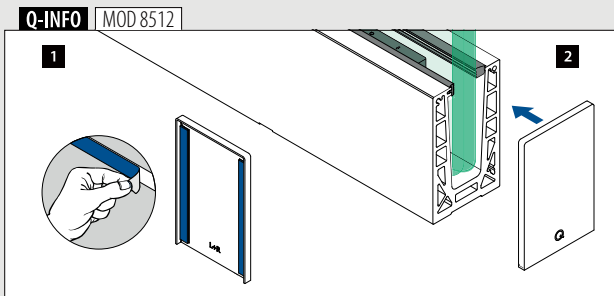
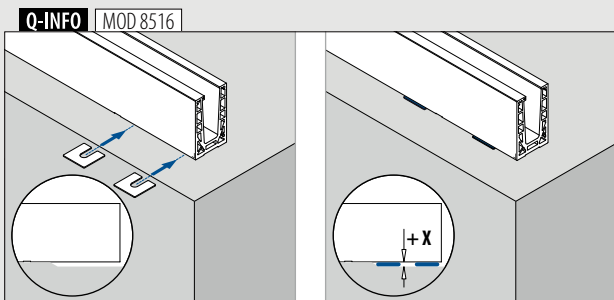

Bodenprofile zur Bodenmontage

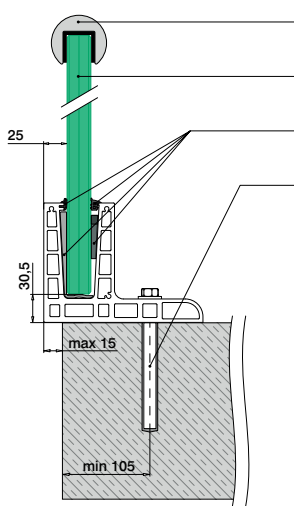

- Glasleistenrohre: ■ 169 - 185
- Kantenschutz: ■ 166 - 168
- VSG gemäss Statik
- Safety Wedge System: ■ 118
- Anker: ■ 457 - 463

Bitte beachten Sie die Spezifikationen wie Befestigungs- und Glasmasse sowie Glasstypen der jeweiligen Zertifikate und statischen Berechnungen.

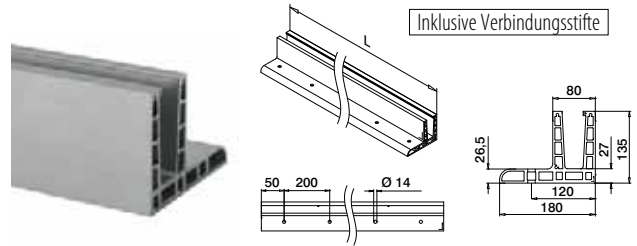

MOD 8520

Aluminium Gebürstet

OUTDOOR

168520-025-00-18 ■ 457 - 463 L = 2,5 m



Internationaler Geschmacksmusterschutz

Ecken zur Bodenmontage

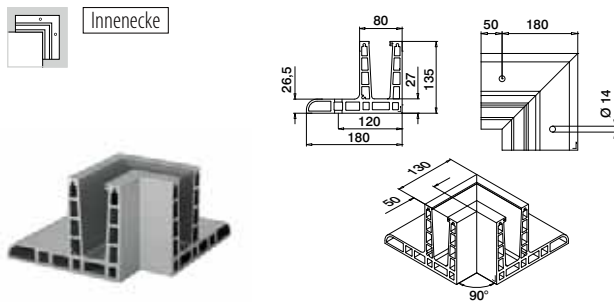

MOD 8521

Aluminium Gebürstet

OUTDOOR

168521-01-18 ■ 457 - 463 1

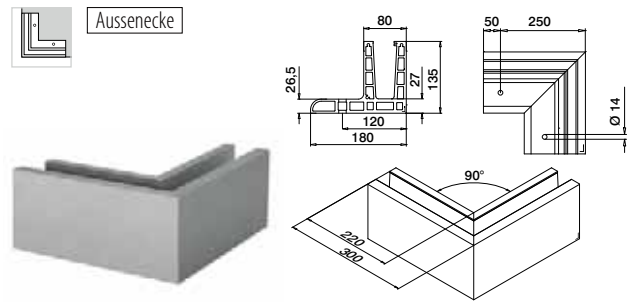

MOD 8521

Aluminium Gebürstet

OUTDOOR

168521-02-18 ■ 457 - 463 1



Endkappen zur Bodenmontage

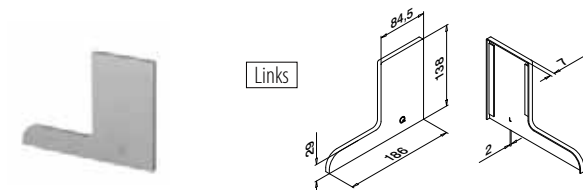

MOD 8522

Aluminium Gebürstet

OUTDOOR

Klebeband

168522-01-18 Angebracht 1

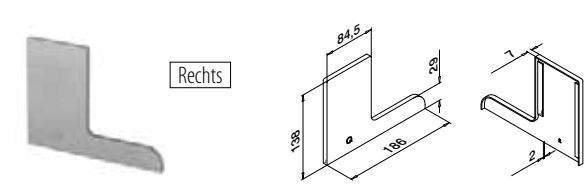

MOD 8522

Aluminium Gebürstet

OUTDOOR

Klebeband

168522-02-18 Angebracht 1

Q-INFO MOD 8520

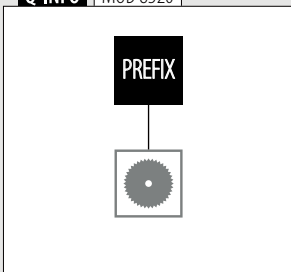

Q-INFO MOD 8520

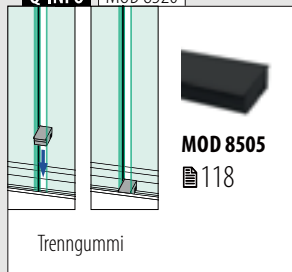

Q-INFO MOD 8522

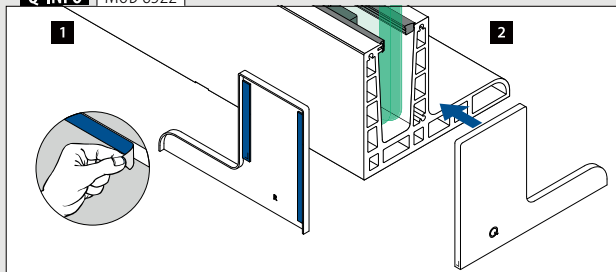

Geländerbasis

Bodenprofile zur Seitenmontage

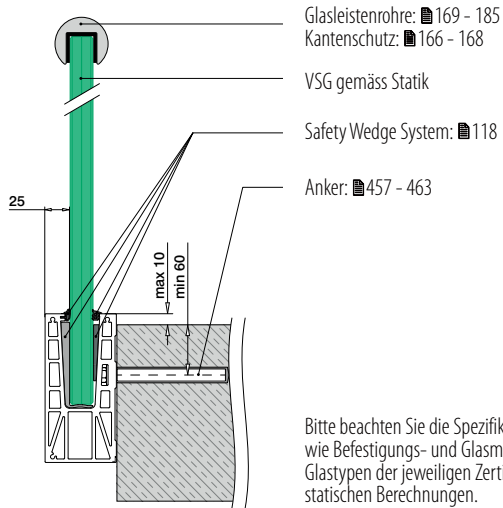

Bitte beachten Sie die Spezifikationen wie Befestigungs- und Glasmasse sowie Glastypen der jeweiligen Zertifikate und statischen Berechnungen.

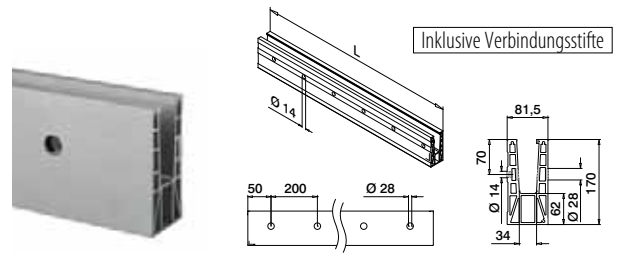

MOD 8530

Aluminium	Gebürstet		
OUTDOOR			
168530-025-00-18	■ 457 - 463		L = 2,5 m



Internationaler Geschmacksmusterschutz

Geländerbasis

Ecken zur Seitenmontage

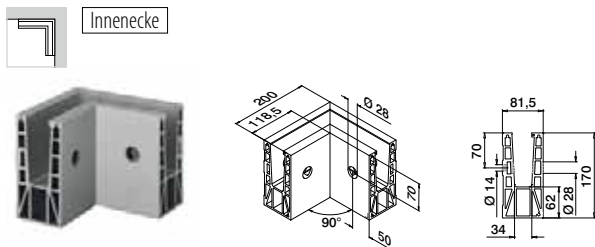

MOD 8531

Aluminium	Gebürstet		
OUTDOOR			
168531-01-18	■ 457 - 463		1

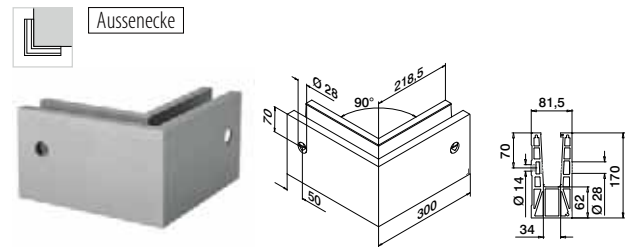

MOD 8531

Aluminium	Gebürstet		
OUTDOOR			
168531-02-18	■ 457 - 463		1



Q-INFO MOD 8530

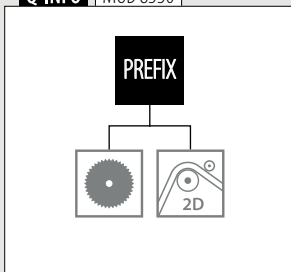

Q-INFO MOD 8530

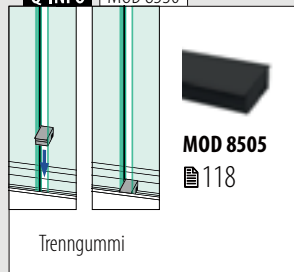

Endkappen zur Seitenmontage



Links

MOD 8532

Aluminium	Gebürstet	
OUTDOOR	Kleband	
168532-01-18	Angebracht	1



Rechts

MOD 8532

Aluminium	Gebürstet	
OUTDOOR	Kleband	
168532-02-18	Angebracht	1

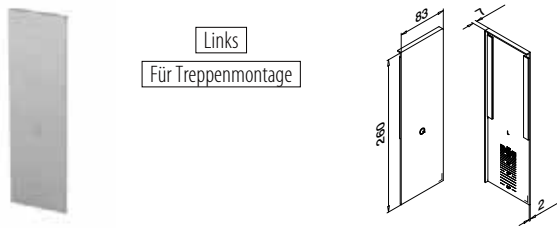

Links

Für Treppenmontage

MOD 8533

Aluminium	Gebürstet	
OUTDOOR	Kleband	
168533-01-18	Angebracht	1

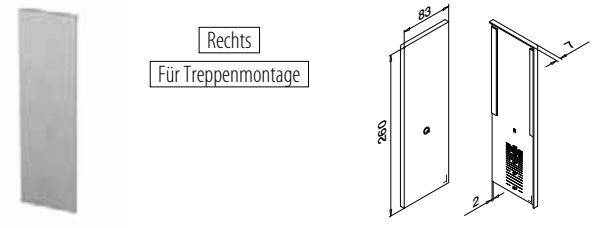

Rechts

Für Treppenmontage

MOD 8533

Aluminium	Gebürstet	
OUTDOOR	Kleband	
168533-02-18	Angebracht	1



Blendleisten zur Seitenmontage

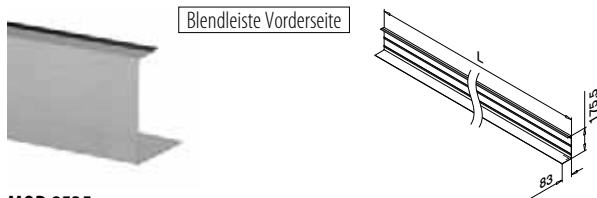

Blendleiste Vorderseite

MOD 8535

Aluminium	Gebürstet	
OUTDOOR	Kleband	
168535-050-18	Angebracht	L = 5 m



Blendstopfen zur Seitenmontage

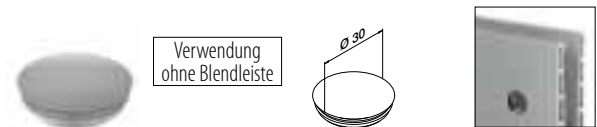

Verwendung ohne Blendleiste

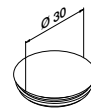

MOD 8538

Kunststoff	Aluminium RAL 9006	
INDOOR		
158538-36		10

Q-INFO MOD 8532 / 8533

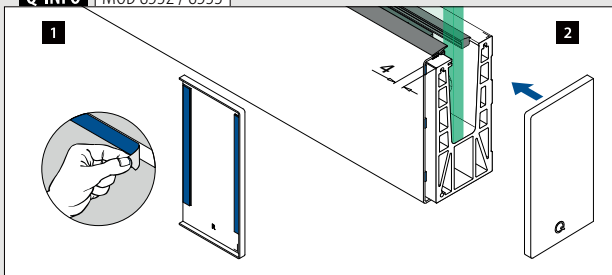

Q-INFO MOD 8533

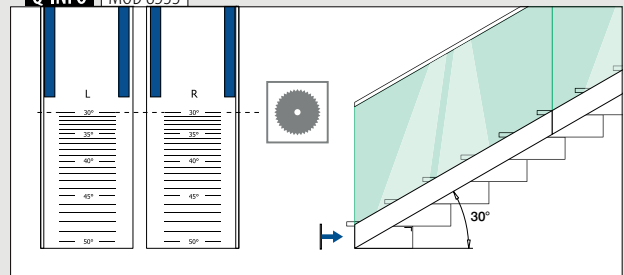

Q-INFO MOD 8535

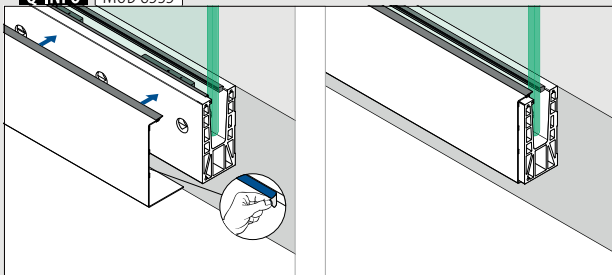

Q-INFO MOD 8538

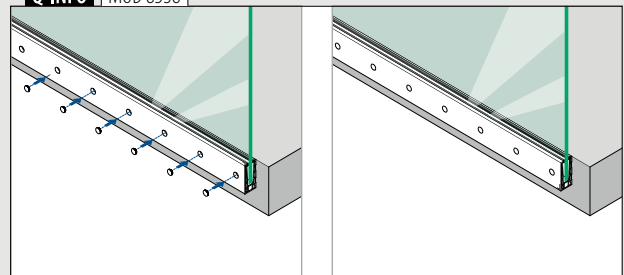

Geländerbasis

Bodenprofile zur Seitenmontage

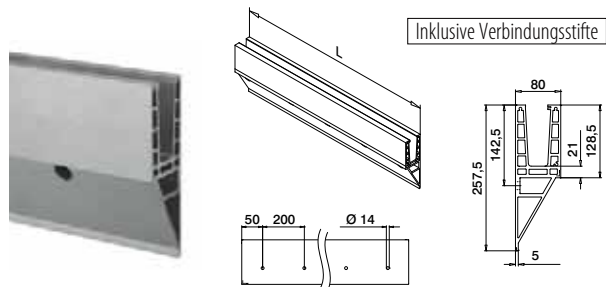
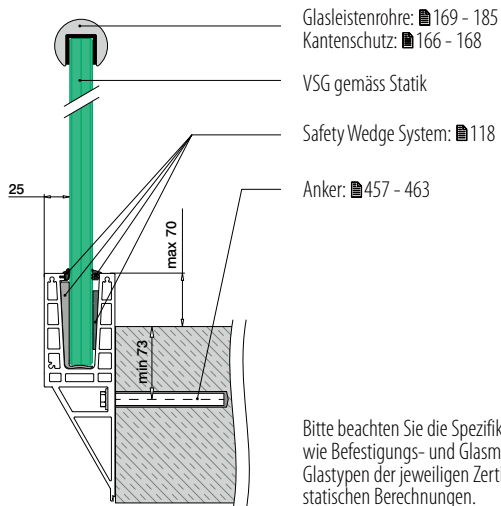

MOD 8540

Aluminium Gebürstet
OUTDOOR

168540-025-00-18 457 - 463 L = 2,5 m



Internationaler Geschmacksmusterschutz

Geländerbasis

Ecken zur Seitenmontage

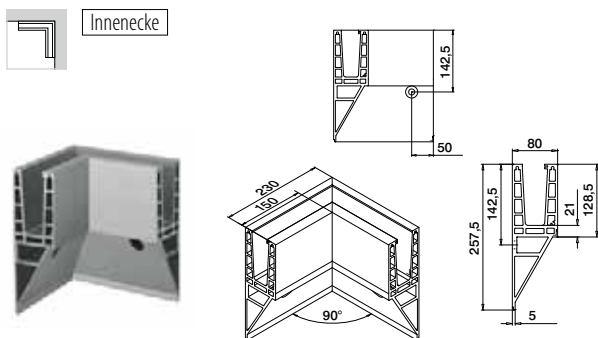

MOD 8541

Aluminium Gebürstet
OUTDOOR

168541-01-18 457 - 463 1

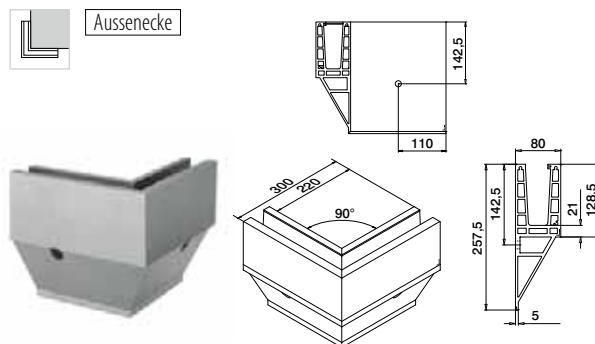

MOD 8541

Aluminium Gebürstet
OUTDOOR

168541-02-18 457 - 463 1



Q-INFO MOD 8540

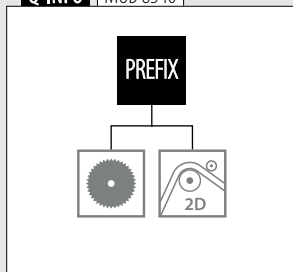

Q-INFO MOD 8540

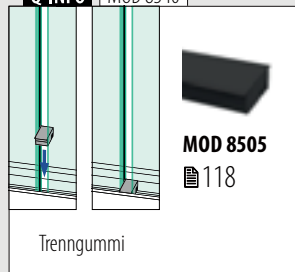

Endkappen zur Seitenmontage

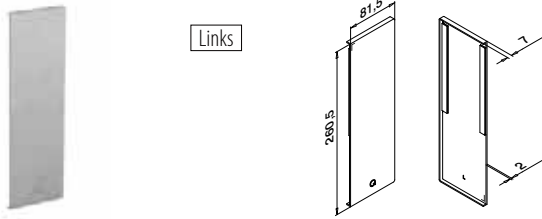

MOD 8542

Aluminium	Gebürstet		
OUTDOOR	Klebeband		
168542-01-18	Angebracht	1	

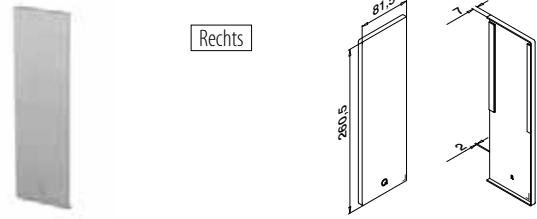

MOD 8542

Aluminium	Gebürstet		
OUTDOOR	Klebeband		
168542-02-18	Angebracht	1	

Blendleisten zur Seitenmontage

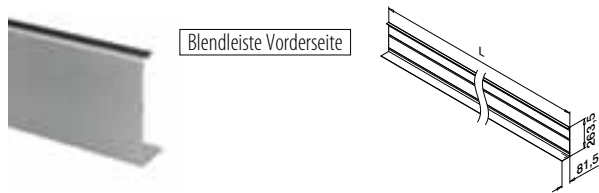

MOD 8545

Aluminium	Gebürstet		
OUTDOOR	Klebeband		
168545-050-18	Angebracht	L = 5 m	



Q-INFO MOD 8542

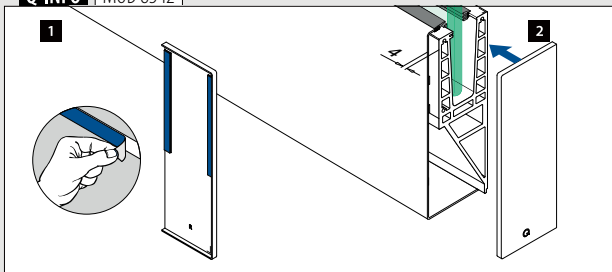

Q-INFO MOD 8545

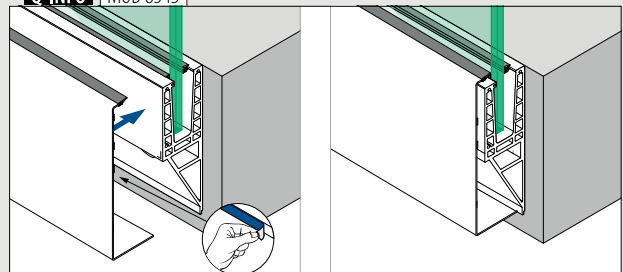



Beanspruchung: Leicht und mittel
Verwendung: Innen- und Aussenbereich
Varianten: Boden, In-Boden- und Seitenmontage
Anwendung: Balkone, Galerien und Dachterrassen
Material: Aluminium (roh oder gebürstet anodisiert)
Glasstärke: 12 bis 17,52 mm, max. 700 mm hoch

Finden Sie alle Informationen zu Easy Glass Up online:

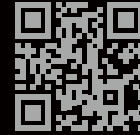

<https://q-ne.ws/Up23>

EASY GLASS[®] UP

Ungestörte Sicht - Die ideale Lösung für Aufkantungen

Easy Glass® Up ist die ultimative Lösung für Bereiche, die von Aufmauerungen umschlossen sind. Die ultraschlanken Bodenprofile – entweder für die Boden- oder Seitenmontage – sorgen für eine ungestörte Sicht. Mit Up können Sie Balkongeländer mit bis zu 700 mm hohen Glasfüllungen errichten. So bereichern Sie jede Dachterrasse.



Easy Glass® Up	CH
Max. Holmlast (kN/m)	1.6



Bitte beachten Sie die Spezifikationen wie Befestigungs- und Glasmasse sowie Glastypen der jeweiligen Zertifikate.

International getestet/berechnet/zertifiziert:



- 1 Mit einem nur 80 mm hohen bodenmontierten Profil ermöglicht Up eine perfekte Aussicht von jedem Balkon oder jeder Terrasse mit Aufmauerungen.
- 2 Sie können alles bequem von der Innenseite aus montieren.



EASY GLASS® UP MONTAGEOPTIONEN

Up Bodenmontage

- Für Aufmauerungen
- Auch für die In-Bodenmontage geeignet

130

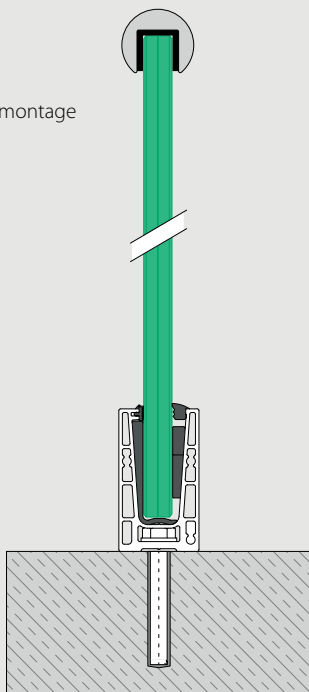

Up Seitenmontage

- Für Aufmauerungen (inverse Montage)
- Optionale Bodenprofil-Blendleiste

131

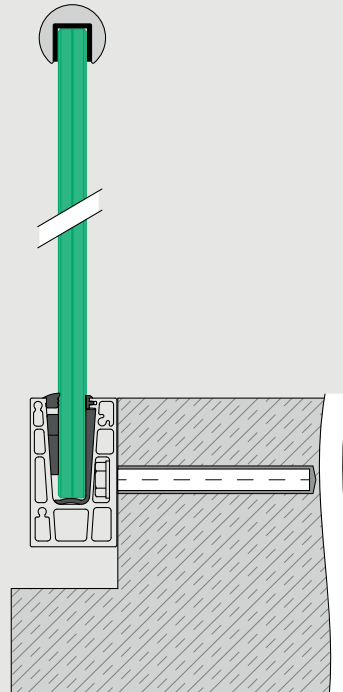

Geländerbasis

Safety Wedge System (Gummi- und Keilsets)

Glasklemmung (nicht justierbar)

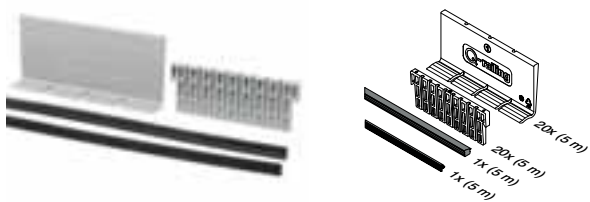

MOD 6600

Zubehör

Für monolithisches Glas	T	
206600-050-12	12	L = 5 m
206600-050-15	15	L = 5 m

Für laminiertes Glas

206600-050-13	12,76	L = 5 m
206600-050-14	13,52	L = 5 m
206600-050-17	16,76	L = 5 m
206600-050-18	17,52	L = 5 m

Zubehör

Easy Glass® Multitool



MOD 1001

Zubehör

	Q	
201001	Q-71	1

Geländerbasis

Verbindungsstifte

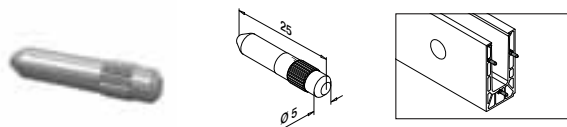

MOD 3005

V4A	316	Roh	
	OUTDOOR		
143005			6



Q-INFO MOD 6600

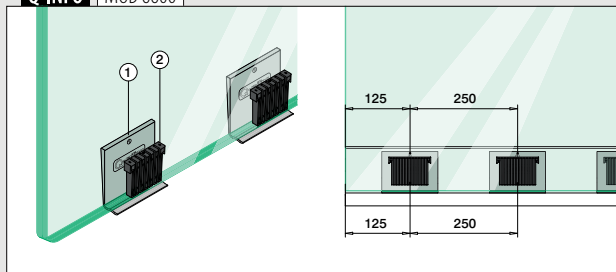

Q-INFO MOD 1001

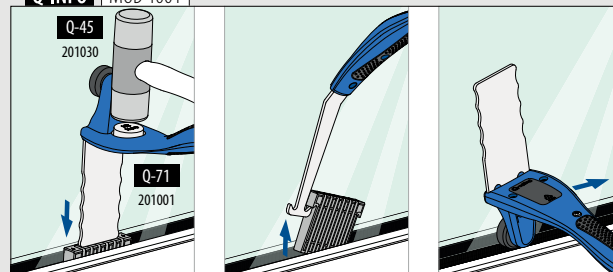



Geländerbasis

Bodenprofile zur Bodenmontage

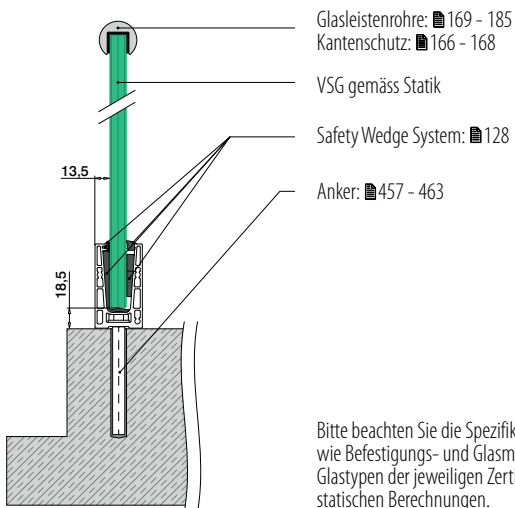

Bitte beachten Sie die Spezifikationen wie Befestigungs- und Glasmasse sowie Glastypen der jeweiligen Zertifikate und statischen Berechnungen.

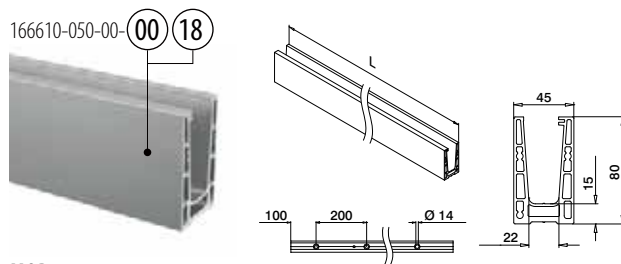

MOD 6610

Aluminium	Roh		
166610-050-00-00	457 - 463	L = 5 m	
Aluminium	Gebürstet		
OUTDOOR			
166610-050-00-18	457 - 463	L = 5 m	



Internationaler Geschmacksmusterschutz

Geländerbasis

Ecken zur Bodenmontage

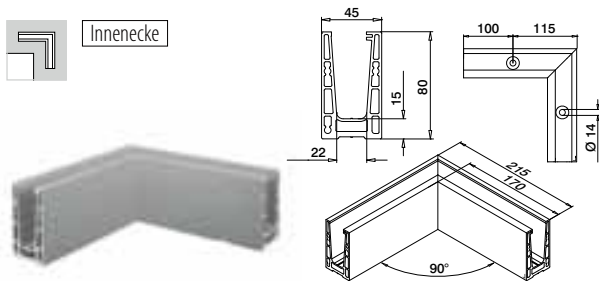

MOD 6611

Aluminium	Gebürstet		
OUTDOOR			
166611-01-18	457 - 463	1	

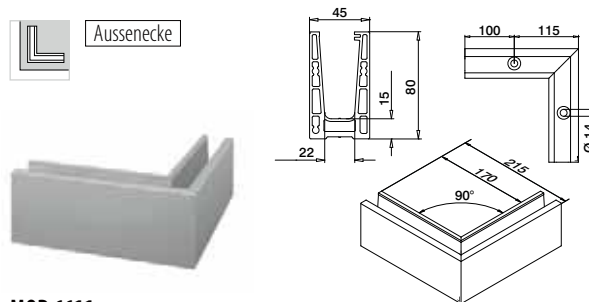

MOD 6611

Aluminium	Gebürstet		
OUTDOOR			
166611-02-18	457 - 463	1	



Geländerbasis

Endkappen zur Bodenmontage

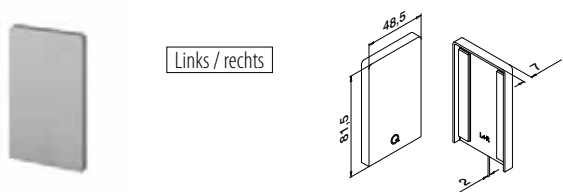

MOD 6612

Aluminium	Roh		
Klebeband			
166612-00-00	Beigelegt	1	
Aluminium	Gebürstet		
OUTDOOR			
166612-00-18	Angebracht	1	

Q-INFO MOD 6610

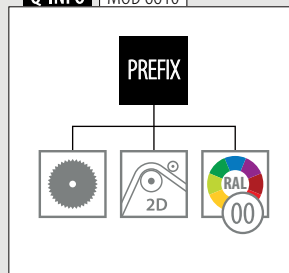

Q-INFO MOD 6610 / 6611



Q-INFO MOD 6612

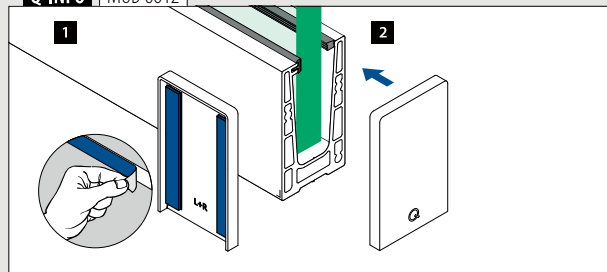

Bodenprofile zur Seitenmontage

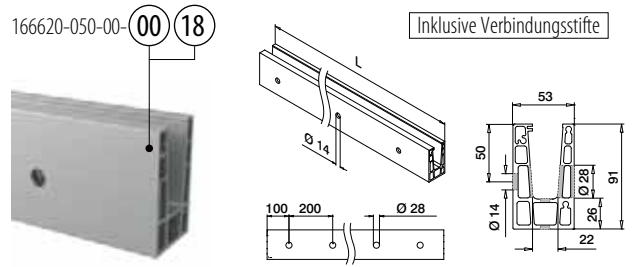
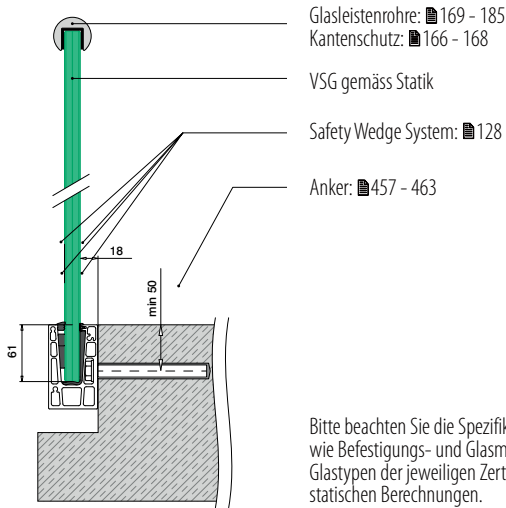

MOD 6620

Aluminium	Roh	X		
166620-050-00-00	100	457 - 463	L = 5 m	
Aluminium	Gebürstet			
166620-050-00-18	100	457 - 463	L = 5 m	



Internationaler Geschmacksmusterschutz

Ecken zur Seitenmontage

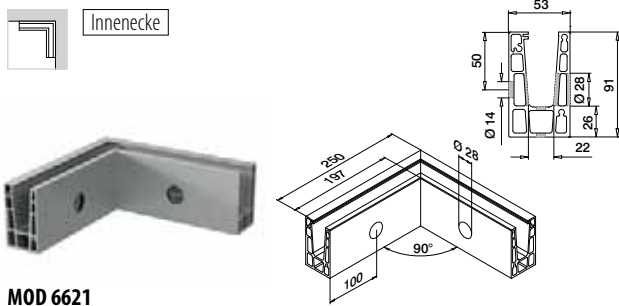

MOD 6621

Aluminium	Gebürstet			
OUTDOOR				
166621-01-18	457 - 463	1		

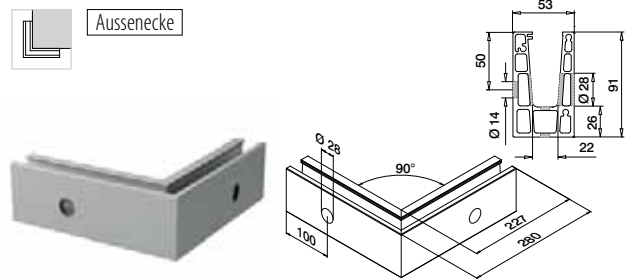

MOD 6621

Aluminium	Gebürstet			
OUTDOOR				
166621-02-18	457 - 463	1		



Q-INFO MOD 6620

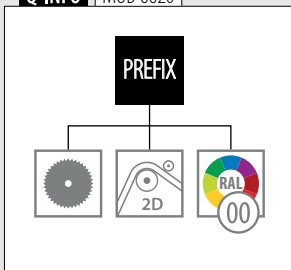

Q-INFO Aluminium

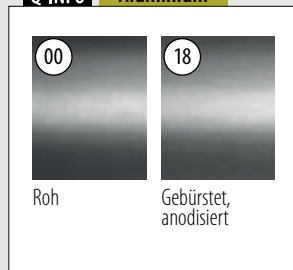

Q-INFO



Geländerbasis

Endkappen zur Seitenmontage

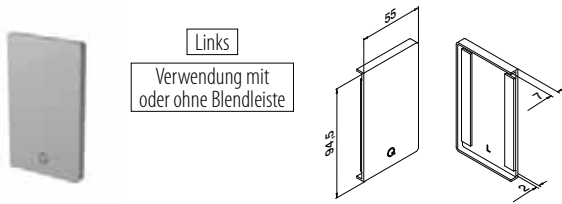

MOD 6622

Aluminium	Roh		
		Klebeband	
166622-01-00		Beigelegt	1
Aluminium	Gebürstet		
OUTDOOR			
166622-01-18		Angebracht	1

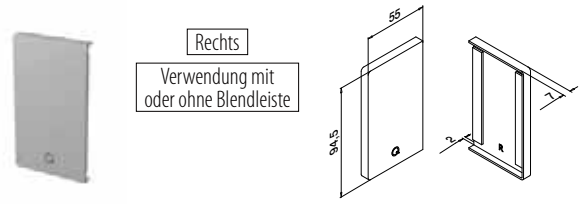

MOD 6622

Aluminium	Roh		
		Klebeband	
166622-02-00		Beigelegt	1
Aluminium	Gebürstet		
OUTDOOR			
166622-02-18		Angebracht	1

Geländerbasis

Blendleisten zur Seitenmontage

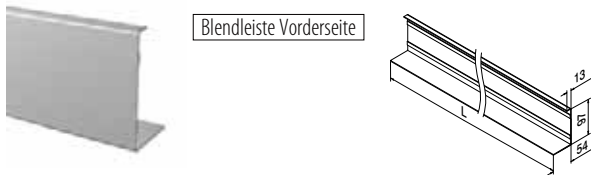

MOD 6625

Aluminium	Roh		
		Klebeband	
166625-050-00		Nicht inkl.*	L = 5 m
Aluminium	Gebürstet		
OUTDOOR			
166625-050-18		Angebracht	L = 5 m



*Bestellen Sie MOD 1360 (Klebeband)

Zubehör

Acrylat-Klebeband



MOD 1360

	Zubehör			
	Q	W	L	
201360	Q-53	9	33 m (für 11 m Blendleiste)	1

Q-INFO | MOD 6625

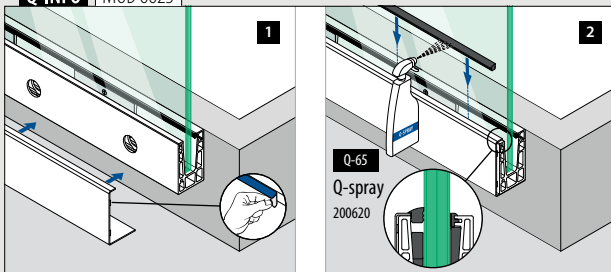

Q-INFO | MOD 6625-050-00 / 1360



Q-INFO | Aluminium

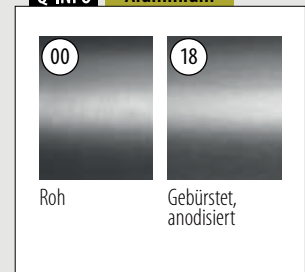

Drainageleisten zur Seitenmontage

8 Stück für 5-Meter-Bodenprofil

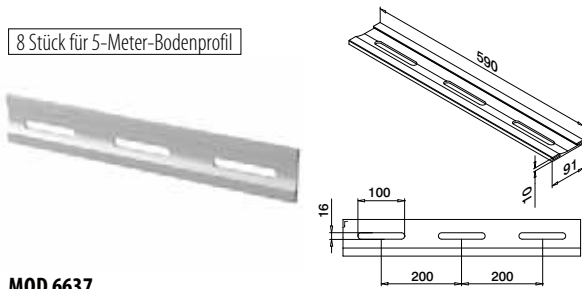

MOD 6637

Aluminium Gebürstet
OUTDOOR

166637-18



4

Unterlegscheiben zur Seitenmontage

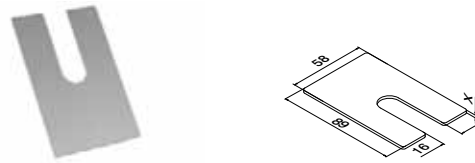

MOD 6636

Aluminium Roh

	X	
166636-001	1	100
166636-002	2	100
166636-003	3	100

Blendstopfen zur Seitenmontage

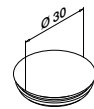
Verwendung
ohne Blendeiste

MOD 8538

Kunststoff Aluminium RAL 9006
INDOOR

158538-36



10

Q-INFO MOD 6637

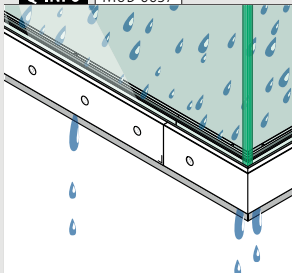

Montage-Informationen:

[https://q-ne.ws/
Up23](https://q-ne.ws/Up23)

Q-INFO MOD 8538

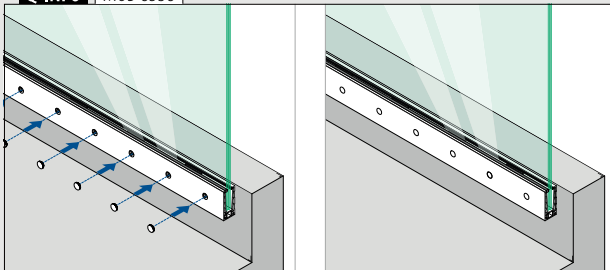

Q-INFO MOD 6636

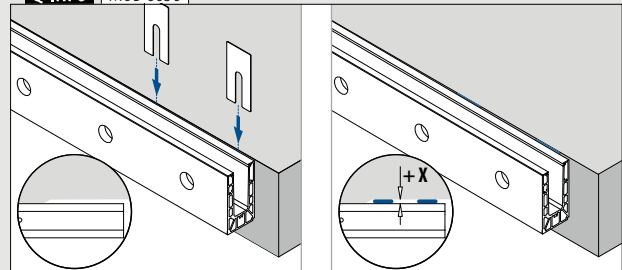



Beanspruchung: Leicht und mittel
Verwendung: Innen- und Aussenbereich
Varianten: Montage zwischen Wänden
Anwendung: Balkone und französische Balkone
Material: Aluminium (roh, matt Silbereffekt, gebürstet anodisiert oder pulverbeschichtet in RAL 9005 schwarz), Stahl (pulverbeschichtet RAL 7047 oder KTL-beschichtet), Edelstahl (gebürstet oder pulverbeschichtet RAL 9005 schwarz)
Glasstärke: 8 bis 13,52 mm

Finden Sie alle Informationen zu Easy Glass Hybrid online:

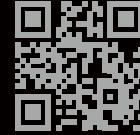

<https://q-ne.ws/Hybrid23>

EASY GLASS® HYBRID

Das minimalistische Balkongeländer

Wenn Sie ein Geländer zwischen zwei Wänden anbringen möchten, zum Beispiel auf einem nicht auskragenden Balkon, ist Easy Glass® Hybrid die ideale Lösung. Mit einem minimalistischen Bodenprofil und robusten Wandanschlüssen schafft dieses System eine transparente und dennoch starke Struktur für Spannweiten von bis zu 2,400 mm.



Easy Glass® Hybrid	CH
Max. Holmlast (kN/m)	0,8
Max. Breite (Meter)	2,4



Bitte beachten Sie die Spezifikationen wie Befestigungs- und Glasmasse sowie Glastypen der jeweiligen Zertifikate.

International getestet/berechnet/zertifiziert:



- 1 Die perfekte Lösung für nicht auskragende Balkone. Hybrid ist das minimalistischste Glasgeländer zur Montage zwischen zwei Wänden.
- 2 Schaffen Sie ununterbrochene Glasbreiten von bis zu 2,400 mm.
- 3 Hybrid bietet ein modernes Design für Bodenprofil und Handlauf.



EASY GLASS® HYBRID

Hybrid

Bodenmontage

- Montage zwischen zwei Wänden

136

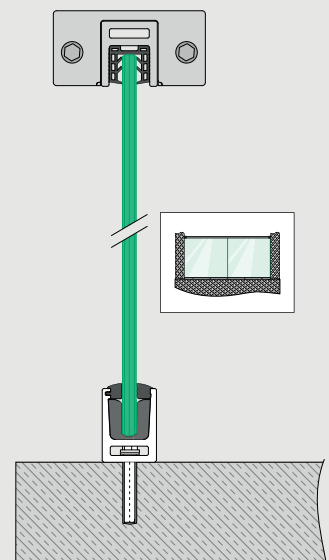

Geländerbasis

Bodenprofile zur Bodenmontage - zwischen zwei Wänden

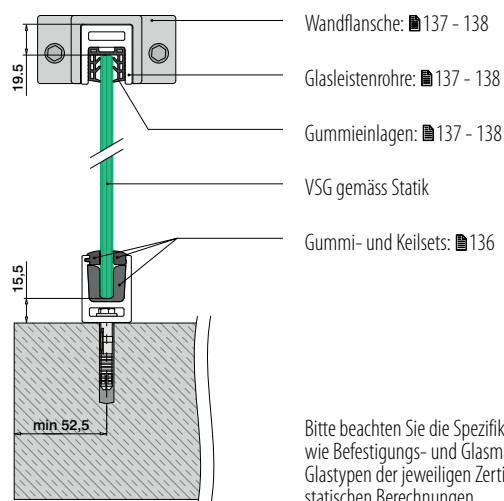

Bitte beachten Sie die Spezifikationen wie Befestigungs- und Glasmasse sowie Glastypen der jeweiligen Zertifikate und statischen Berechnungen.

Geländerbasis

Endkappen



MOD 6912

Aluminium	Roh		
Kleband			
166912-00-00	Beigelegt		2
Aluminium	Matt Silbereffekt		
OUTDOOR			
SELL OUT	166912-00-08	Angebracht	2
Aluminium	Gebürstet		
OUTDOOR			
NEW	166912-00-18	Angebracht	2
Aluminium	Black Line		
OUTDOOR			
NEW	166912-00-82	Beigelegt	2

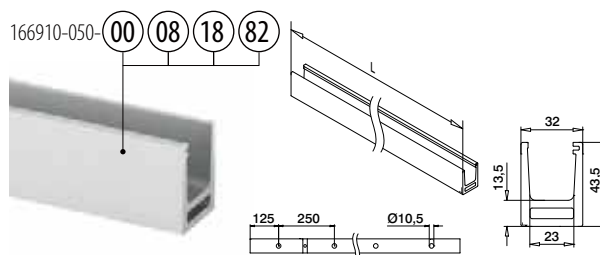

MOD 6910

Aluminium	Roh		
166910-050-00	QS-213	468	L = 5 m
Aluminium	Matt Silbereffekt		
OUTDOOR			
SELL OUT	166910-050-08	QS-213	468 L = 5 m
Aluminium	Gebürstet		
OUTDOOR			
NEW	166910-050-18	QS-213	468 L = 5 m
Aluminium	Black Line		
OUTDOOR			
NEW	166910-050-82	QS-213	468 L = 5 m



Internationaler Geschmacksmusterschutz

Geländerbasis

Gummi- und Keilsets

Glasklemmung (nicht justierbar)

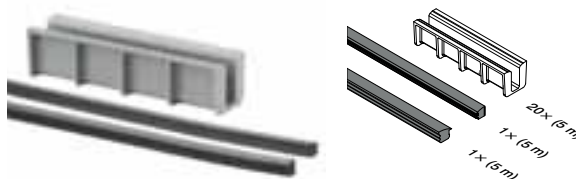

MOD 6910

Zubehör			
Für monolithisches Glas			
	T		
206910-08	8		L = 5 m
206910-10	10		L = 5 m
Für laminiertes Glas			
206910-08	8,76 - 9,52		L = 5 m
206910-10	10,76 - 11,52		L = 5 m
206910-13	12,76 - 13,52		L = 5 m

Internationaler Geschmacksmusterschutz

SELL OUT Nur solange der Vorrat reicht.

Q-INFO MOD 6910

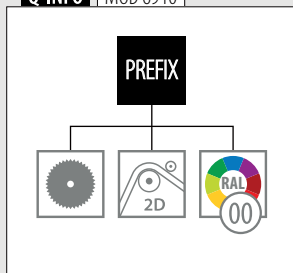

Q-INFO MOD 6912

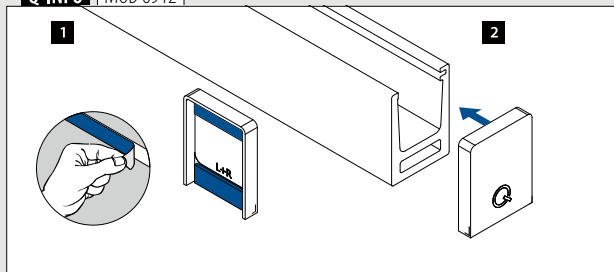

Q-INFO Aluminium

00	08	18	82 RAL 9005
Roh	Mattsilbereffekt	Gebürstet, anodisiert	Schwarz, matt, strukturiert

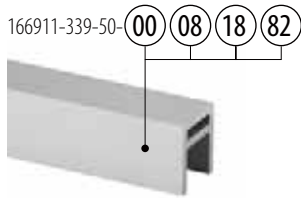

MOD 6911

Aluminium Roh	U	
166911-339-50-00	24	L = 5 m
Aluminium Matt Silbereffekt		
OUTDOOR		
SELL OUT 166911-339-50-08	24	L = 5 m
Aluminium Gebürstet		
OUTDOOR		
NEW 166911-339-50-18	24	L = 5 m
Aluminium Black Line		
OUTDOOR		
NEW 166911-339-50-82	24	L = 5 m



Internationaler Geschmacksmusterschutz

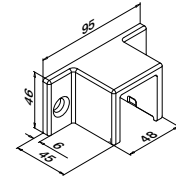

MOD 6515

V4A	316	Gebürstet		
	OUTDOOR			
146515-339-12	QS-214	468		2
V4A	316	Black Line		
	OUTDOOR			
146515-339-82	QS-214	468		2

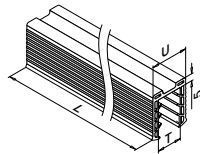

MOD 5124

Zubehör		
U = 24 mm		
Für monolithisches Glas	T	
205124-050-08	8 - 10	L = 5 m
Für laminiertes Glas		
205124-050-08	8,76 - 10,76	L = 5 m
205124-050-11	11,52 - 13,52	L = 5 m

Q-INFO MOD 6911

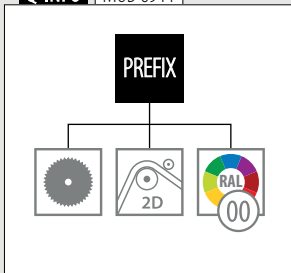

Q-INFO 316



Q-INFO

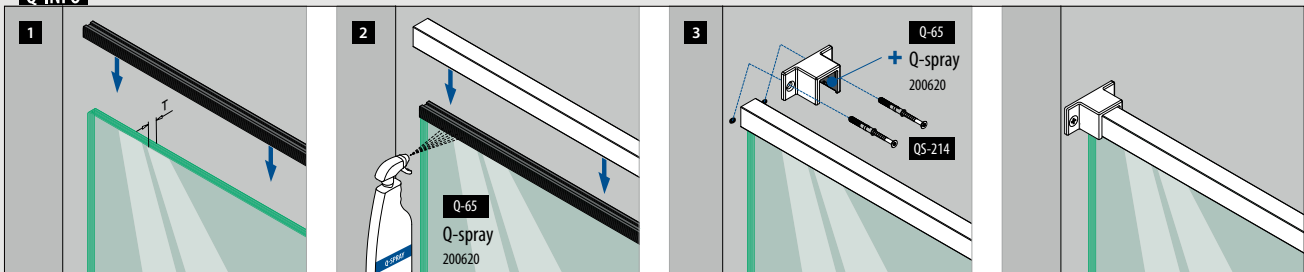

Glasleistenrohre

Glasleistenrohre

HYBRID 65x40

166924-654-50-00 00 08

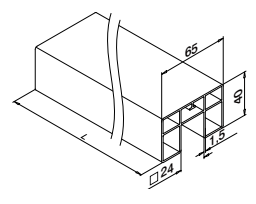
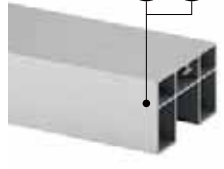

MOD 6924

Aluminium Roh

166924-654-50-00	65 x 40	L = 5 m
------------------	---------	---------

Aluminium Matt Silbereffekt

166924-654-50-08	65 x 40	L = 5 m
------------------	---------	---------

SELL OUT



Internationaler Geschmacksmusterschutz

Glasleistenrohre

Wandflansche

HYBRID 65x40

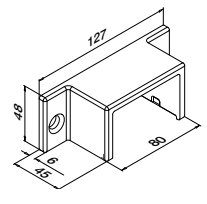

MOD 6515

Stahl Pulverbeschichtet RAL 7047

116515-654-34	QS-214	468	2
---------------	--------	-----	---

SELL OUT

Stahl KTL-beschichtet

116515-654-30	QS-214	468	2
---------------	--------	-----	---

SELL OUT



Glasleistenrohre

Gummieinlagen

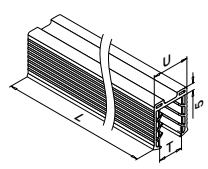

MOD 5124

Zubehör

U = 24 mm

Für monolithisches Glas	T	
205124-050-08	8 - 10	L = 5 m

Für laminiertes Glas

205124-050-08	8,76 - 10,76	L = 5 m
205124-050-11	11,52 - 13,52	L = 5 m

SELL OUT Nur solange der Vorrat reicht.

Q-INFO MOD 6924

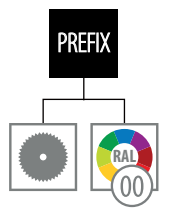

Q-INFO MOD 6924

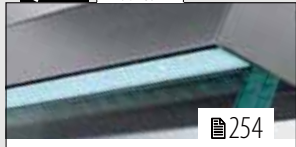

Fügen Sie mithilfe des MOD 6926 Glasleistenrohres eine LED-Beleuchtung (Linear Light) hinzu

Q-INFO Stahl MOD 6515

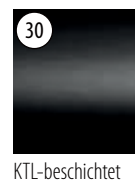

E-coat (KTL), auch elektrophoretische Beschichtung genannt, ist eine dünne Schicht (15 µ), die Stahlprodukten einen Schutzfilm (Grundierung) verleiht. Nach der E-Beschichtung ist das Produkt bereit für die finale Oberflächenbehandlung, beispielsweise eine Lackierung oder eine Pulverbeschichtung.

Q-INFO

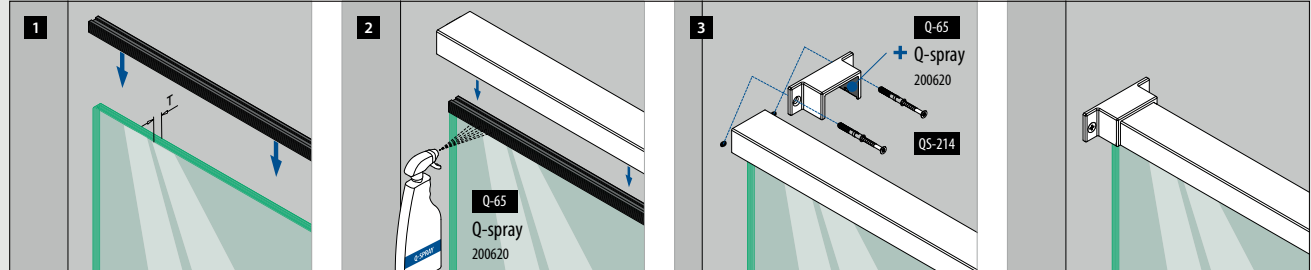





Verwendung: Innen- und Aussenbereich
Anwendung: Balkone, Galerien, Wege, Abtrennungen und Treppen
Material: Edelstahl (gebürstet, hochglanzpoliert oder pulverbeschichtet RAL 9005 schwarz)
Glasstärke: 12 bis 21,52 mm

Finden Sie alle Informationen zu Easy Glass Bodenglasklemmen online:



<https://q-ne.ws/BaseGlassClamps23>

EASY GLASS®

BODENGLAS- KLEMMEN

BEEINDRUCKENDE
OPTIONEN

MOD 6100

144

- Für leichte Beanspruchung
- Flansch mit Langlöchern
- Befestigung durch das Glas hindurch



MOD 6200

145

- Für leichte Beanspruchung
- Flansch mit Langlöchern
- Befestigung durch das Glas hindurch

Für Glasgeländer mit einem einzigartigen Look



MOD 6000

142

- Für leichte Beanspruchung
- Installation mittels eines einzigen Ankers
- Glas wird geklemmt
- Optionaler Sicherungstift
- Integrierte Wasserwaage
- Ohne sichtbare Schrauben



MOD 6400

143

- Für leichte bis mittlere Beanspruchung
- Installation mittels zwei Anker
- Glas wird geklemmt
- Sicherungstift wird nicht benötigt
- Ohne sichtbare Schrauben

MOD 6400

CH

Max. Holmlast (kN/m)

0.8

Bitte beachten Sie die Spezifikationen wie Befestigungs- und Glasmasse sowie Glastypen der jeweiligen Zertifikate. Für weitere Informationen besuchen Sie www.q-railing.com/zertifikate

International getestet/berechnet/zertifiziert:



Geländerbasis

Bodenglasklemmen - MOD 6000

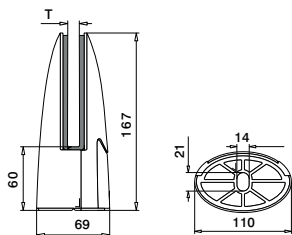

MOD 6000

V4A	316	Gebürstet	T	
OUTDOOR				
146000-12		Siehe T in MOD 5060	457 - 463	1
V4A	316	Hochglanzpoliert	T	
OUTDOOR				
146000-10		Siehe T in MOD 5060	457 - 463	1

Internationaler Geschmacksmusterschutz

Zubehör

Sicherungsstifte

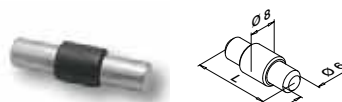

Optional verwendbar für MOD 6000

MOD 5015

Zubehör	L	
205015-24	30	4

Geländerbasis

Gummieinlagen für MOD 6000



2 Stück pro Glasklemme

MOD 5060

Zubehör		
Für monolithisches Glas		
205060-12	12	2
205060-15	15	2
Für laminiertes Glas		
205060-13	12,76	2
205060-14	13,52	2
205060-17	16,76	2
205060-18	17,52	2

SELL OUT Nur solange der Vorrat reicht.

Q-INFO MOD 5015

Optionaler Sicherungsstift. Bitte bestellen Sie Sicherungsstifte und Befestigungsmaterial separat.



MOD 6000

Bodenglasklemmen - MOD 6400

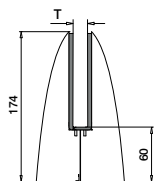
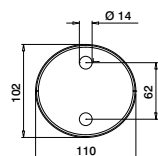
Stahlkern /
Edelstahlverkleidung

MOD 6400

V4A	316	Gebürstet			
	OUTDOOR		T		
	146400-12	Siehe T in MOD 5064		457 - 463	1
V4A	316	Hochglanzpoliert			
	OUTDOOR				
SELL OUT	146400-10	Siehe T in MOD 5064		457 - 463	1

Internationaler
Geschmacksmusterschutz

Gummieinlagen für MOD 6400

1 Set pro
Glasklemme

MOD 5064

Zubehör

Für monolithisches Glas	T	
205064-15	15	1
205064-19	19	1

Für laminiertes Glas

205064-17	16,76	1
205064-18	17,52	1
205064-21	20,76	1
205064-22	21,52	1

Q-INFO 316

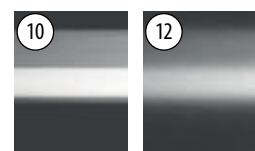
Hochglanz-
poliert

Gebürstet



MOD 6400

Geländerbasis

Bodenglasklemmen - MOD 6100

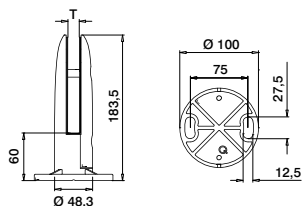

MOD 6100

V4A	316	Gebürstet		
	OUTDOOR		T	
	146100-12	Siehe T in MOD 5061	457 - 463	1
V4A	316	Hochglanzpoliert		
	OUTDOOR			
SELL OUT	146100-10	Siehe T in MOD 5061	457 - 463	1



Geländerbasis

Gummieinlagen für MOD 6100



2 Stück pro Glasklemme

MOD 5061

Zubehör

Für monolithisches Glas		T	
205061-12	12		2
Für laminiertes Glas			
205061-13	12,76		2
205061-17	16,76		2
205061-18	17,52		2

Nicht nach SIA-Norm geprüft, interne Prüfberichte stehen auf Anfrage zur Verfügung.

SELL OUT Nur solange der Vorrat reicht.

Geländerbasis

Abdeckkappen für MOD 6100

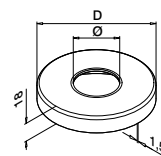

MOD 0512

V4A	316	Gebürstet		
	OUTDOOR		Ø	D
	140512-048-12		48,3	105
V4A	316	Hochglanzpoliert		
	OUTDOOR			
SELL OUT	140512-048-10		48,3	105



MOD 6100

Q-INFO

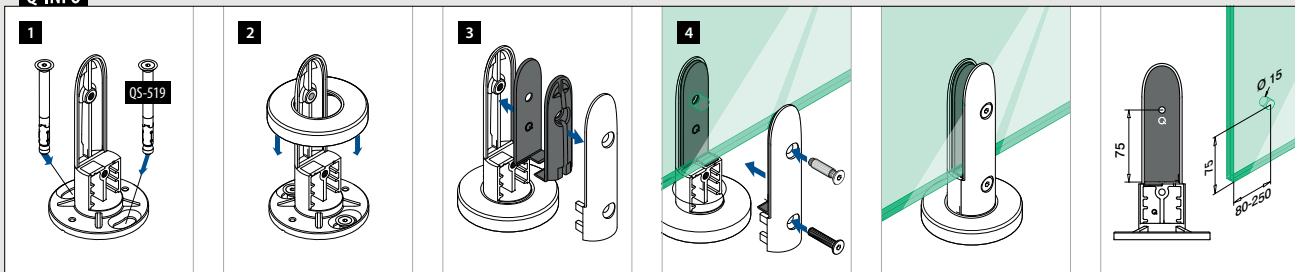

Bodenglasklemmen - MOD 6200

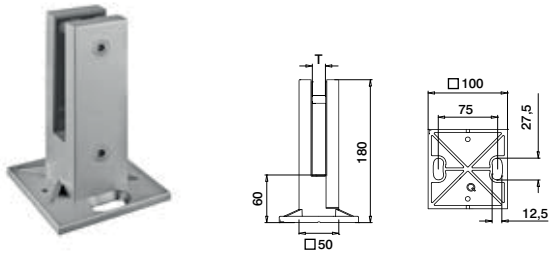

MOD 6200

V4A	316	Gebürstet	T		
	OUTDOOR				
	146200-12		Siehe T in MOD 5062	457 - 463	1
	OUTDOOR				
V4A	316	Hochglanzpoliert	T		
	OUTDOOR				
	146200-10		Siehe T in MOD 5062	457 - 463	1
	OUTDOOR				
V4A	316	Black Line	T		
	OUTDOOR				
NEW	146200-82		Siehe T in MOD 5062	457 - 463	1



Abdeckkappen für MOD 6200



MOD 4562

V4A	316	Gebürstet		
	OUTDOOR			
	144562-12			2
V4A	316	Hochglanzpoliert		
	OUTDOOR			
SELL OUT	144562-10			2
V4A	316	Black Line		
	OUTDOOR			
NEW	144562-82			2

Gummieinlagen für MOD 6200



2 Stück pro Glasklemme

MOD 5062

Zubehör

Für monolithisches Glas	T	
205062-12	12	2
205062-15	15	2
Für laminiertes Glas	T	
205062-13	12,76	2
205062-14	13,52	2
205062-17	16,76	2
205062-18	17,52	2

Nicht nach SIA-Norm geprüft, interne Prüfberichte stehen auf Anfrage zur Verfügung.



Q-INFO 316

10

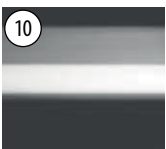

Hochglanzpoliert

12

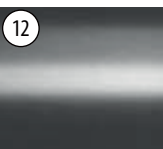

Gebürstet

82 RAL 9005



Schwarz, matt, strukturiert

Q-INFO

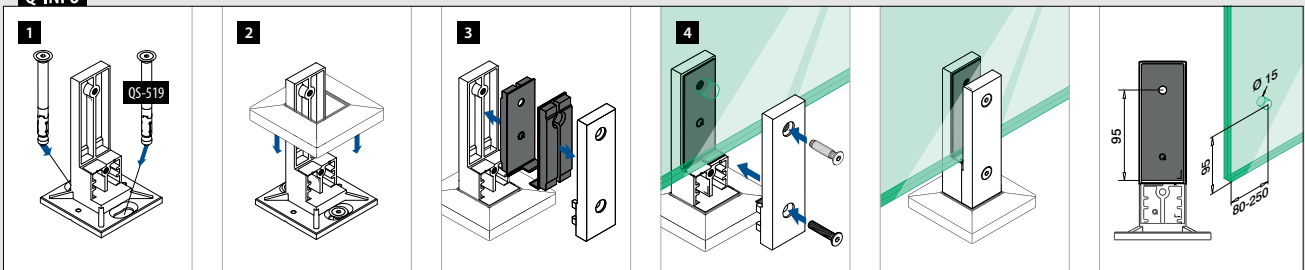



Beanspruchung: Leicht und mittel
Verwendung: Innen- und Aussenbereich
Montage: Bodenmontage
Anwendung: Balkone, Galerien, Wege und Abtrennungen
Material: Edelstahl V4A (glasperlengestrahlt und gebürstet)
Glasstärke: 15 bis 21,52 mm

Finden Sie alle Informationen zu Easy Glass Air online:



<https://q-ne.ws/Air23>

EASY GLASS[®] AIR

Machen Sie den Unterschied

Mit Easy Glass® Air verleihen Sie jedem Haus oder Gewerbeobjekt einen architektonischen Wow-Faktor! Das Glasgeländer verfügt über eine ultramoderne Bodenglasklemme mit einem markanten Aussehen. Das leichte und luftige Design der glasperlengestrahlichten Klemme und des Verbinders erweckt den Eindruck, dass die Glaselemente schweben. Das Ergebnis ist pure Eleganz und maximale Transparenz.



International getestet/berechnet/zertifiziert:



- 1 Air bietet ein harmonisch aufeinander abgestimmtes Design für Bodenglasklemme und Glasverbinder, was es zu einem einzigartigen System auf dem Markt macht.
- 2 Die Klemme lässt sich für Wandanschlüsse zweiteilen; passende Endkappen sind erhältlich.

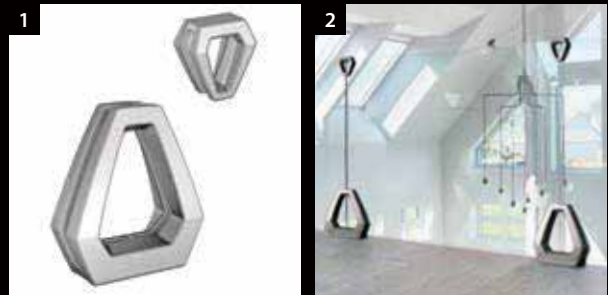

EASY GLASS® AIR DESIGNOPTIONEN

Air
Bodenglasklemme

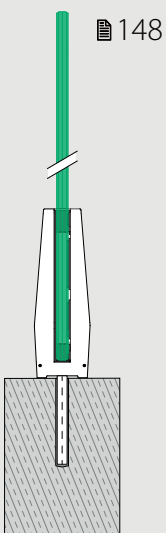

Air
Bodenglasklemme mit Glasverbinder

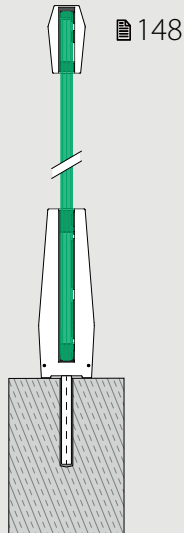

Air
Bodenglasklemme mit Glasverbinder, Handlaufadapter und Handlauf

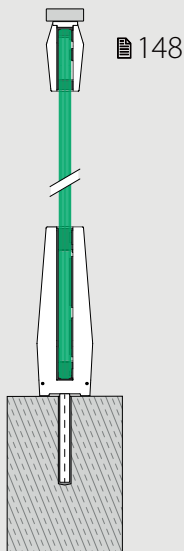

Air
Bodenglasklemme mit Glasleistenrohr, U-Profil oder Kantenschutz

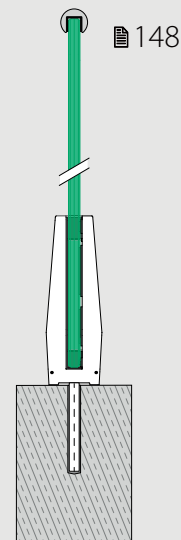

Geländerbasis

Bodenglasklemmen

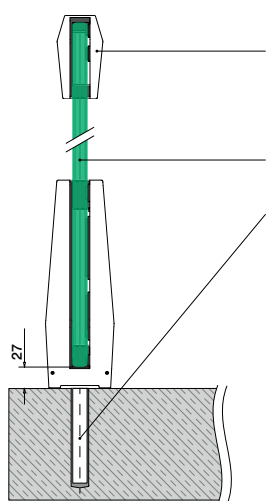

Glasleistenrohre: ■ 169 - 185
 Glasverbinder MOD 6510: ■ 148
 Kantenschutz: ■ 166 - 168
 Handlauf 60x20: ■ 149

VSG gemäss Statik

Anker: ■ 457 - 463

Bitte beachten Sie die Spezifikationen wie Befestigungs- und Glasmasse sowie Glastypen der jeweiligen Zertifikate und statischen Berechnungen.

Geländerbasis

Bodenglasklemmen

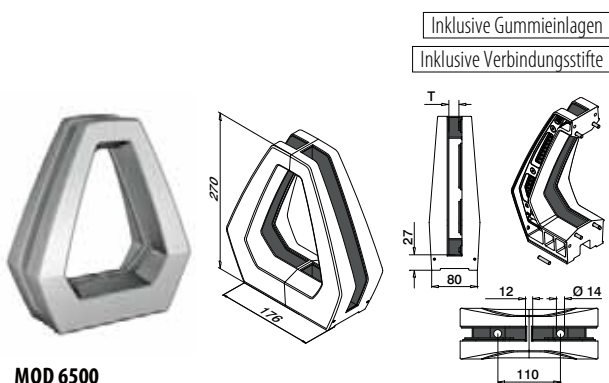

Inklusive Gummieinlagen

Inklusive Verbindungsstifte

MOD 6500

V4A	316	Gebürstet + glasperlengestrahlt	
OUTDOOR		T	
146500-12	15 - 21,52	■ 457 - 463	1



Internationaler Geschmacksmusterschutz

Handläufe

Glasverbinder

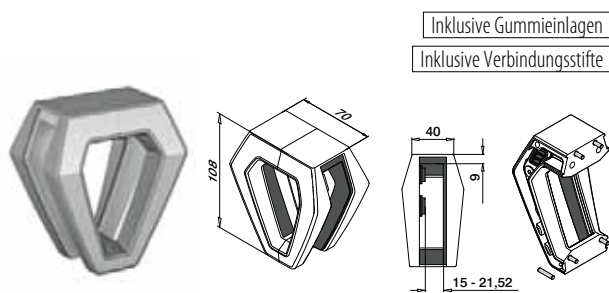

Inklusive Gummieinlagen

Inklusive Verbindungsstifte

MOD 6510

V4A	316	Gebürstet + glasperlengestrahlt	
OUTDOOR			
146510-12			1



Internationaler Geschmacksmusterschutz

Geländerbasis

Endkappen für Bodenglasklemmen

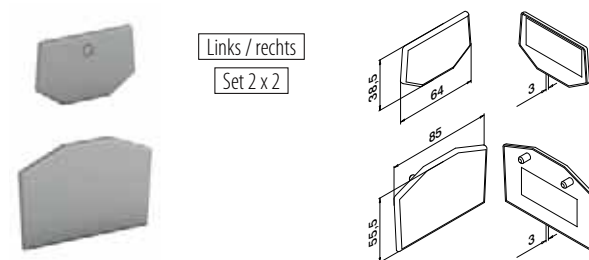

Links / rechts

Set 2 x 2

MOD 6502

V4A	316	Glasperlengestrahlt	
OUTDOOR			
146502-02			Set

Internationaler Geschmacksmusterschutz

Handläufe

Endkappen für Glasverbinder

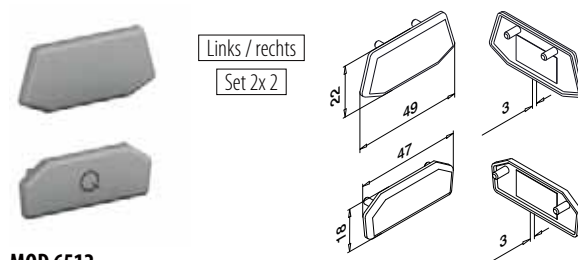

Links / rechts

Set 2x 2

MOD 6512

V4A	316	Glasperlengestrahlt	
OUTDOOR			
146512-01			Set

Internationaler Geschmacksmusterschutz

Handläufe
Handlaufadapter

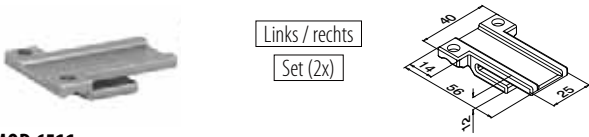

Links / rechts
Set (2x)

MOD 6511

V4A	316	Glasperlengestrahlt		
	OUTDOOR	T		
146511-02	15 - 21,52	QS-13	472	Set



Internationaler Geschmacksusterschutz

Handläufe
Endkappen



MOD 5728 - EASY HIT®

V4A	316	Gebürstet		
	OUTDOOR	Für		
145728-062-12	60 x 20 x 2,0			2



Internationaler Geschmacksusterschutz

Handläufe
Rohre

Q-TUBE

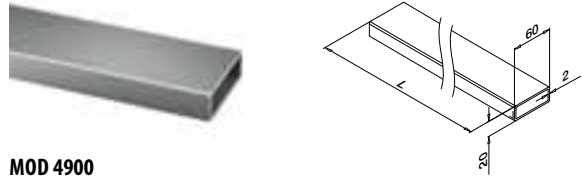

MOD 4900

V4A	316	Gebürstet		
	OUTDOOR			
144900-062-25-12	60 x 20 x 2,0			L = 2,5 m
144900-062-50-12	60 x 20 x 2,0			L = 5 m



Internationaler Geschmacksusterschutz

Handläufe
Wandflansche

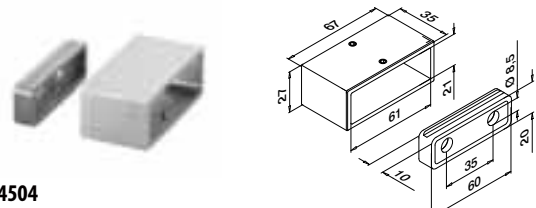

MOD 4504

V4A	316	Gebürstet		
	OUTDOOR	Für		
144504-062-12	60 x 20 x 2,0	QS-55	470 / QS-27	472
				2



Internationaler Geschmacksusterschutz

Q-INFO MOD 4900

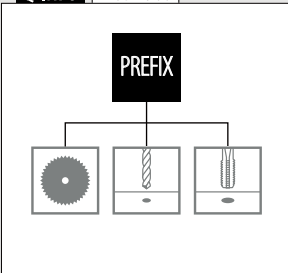

Q-INFO MOD 4504

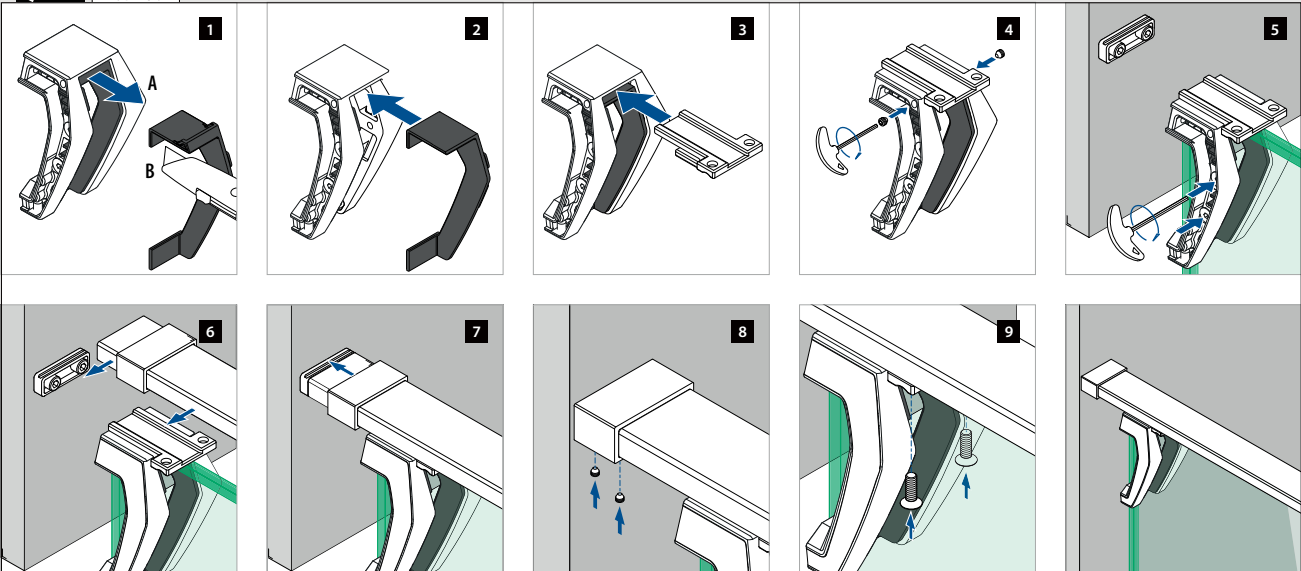



Beanspruchung: Leicht
Verwendung: Innen- und Aussenbereich
Montage: Boden-, In-Boden- und Seitenmontage
Anwendung: Balkone, Galerien, Wege, Abtrennungen, Treppen und französische Balkone
Material: Edelstahl (gebürstet, hochglanzpoliert oder pulverbeschichtet RAL 9005 schwarz), Zinkdruckguss (roh oder Edelstahleffekt)
Glasstärke: 12 bis 21,52 mm

Finden Sie alle Informationen zu Easy Glass Glasadapter online:



<https://q-ne.ws/GlassAdapters23>

EASY GLASS®

GLAS-ADAPTER

WENIGER IST MEHR

MOD
0745-0748

154 - 155

- Unterschiedliche Durchmesser und Wandabstände

MOD 4747

158

- Unterschiedliche Glasdicken

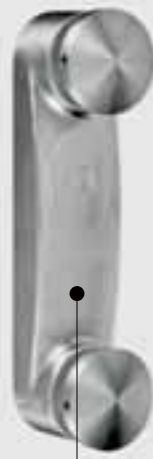
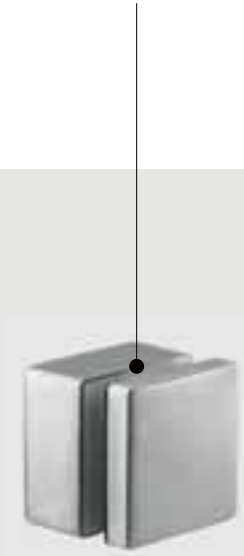

MOD 4762

158

- Installation mittels eines einzigen Ankers (optional: zusätzliche zweite Verankerung)
- Integrierte Wasserwaage



MOD 0760-0766

156

- Installation mittels eines einzigen Ankers
- Einstellbarer Winkel bei MOD 0766
- MOD 0760 und 0762 besitzen eine integrierte Wasserwaage

MOD 0749

152

- Glasjustierung während der gesamten Installation möglich



International getestet/berechnet/
zertifiziert:



MOD 0763

159

- Installation mittels eines einzigen Ankers (optional: zusätzliche zweite Verankerung)
- Glasklemme und Adapter in einem (dank verstellbarem Glasstift)

International getestet/berechnet/
zertifiziert:



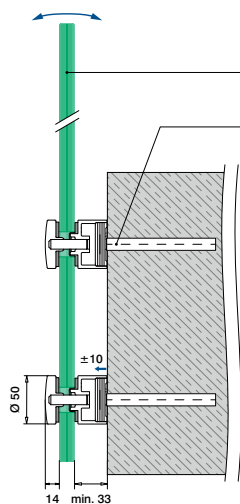

VSG gemäss Statik
Anker: 457 - 463

Bitte beachten Sie die Spezifikationen wie Befestigungs- und Glasmasse sowie Glasstypen der jeweiligen Zertifikate und statischen Berechnungen.

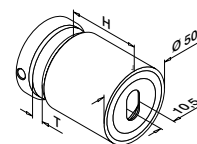

MOD 0749

V2A	304	Gebürstet		
INDOOR*		H	T	
	130749-030-12	30	12 - 25,52	457 - 463 2
	130749-040-12	40	8 - 25,52	457 - 463 2
	130749-050-12	50	8 - 25,52	457 - 463 2

V2A	304	Black Line		
INDOOR*		H	T	
NEW	130749-030-82	30	12 - 25,52	457 - 463 2
NEW	130749-040-82	40	8 - 25,52	457 - 463 2
NEW	130749-050-82	50	8 - 25,52	457 - 463 2

V4A	316	Gebürstet		
OUTDOOR		H	T	
	140749-030-12	30	12 - 25,52	457 - 463 2
	140749-040-12	40	8 - 25,52	457 - 463 2
	140749-050-12	50	8 - 25,52	457 - 463 2
	140749-100-12	100	8 - 25,52	457 - 463 2

V4A	316	Black Line		
OUTDOOR		H	T	
NEW	140749-030-82	30	12 - 25,52	457 - 463 2
NEW	140749-040-82	40	8 - 25,52	457 - 463 2
NEW	140749-050-82	50	8 - 25,52	457 - 463 2

V4A	316	Hochglanzpoliert		
OUTDOOR		H	T	
	140749-050-10	50	8 - 25,52	457 - 463 2



* Auch für Aussenanwendung geeignet bei entsprechenden Bedingungen.

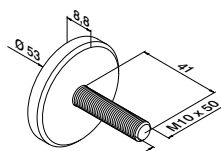

MOD 0741

V4A	316	Roh	
OUTDOOR		H	
	140741-150		2



Q-INFO 316 304

10 Hochglanzpoliert	12 Gebürstet	82 RAL 9005 Pulverbeschichtet
-------------------------------	------------------------	---

Q-INFO MOD 0749

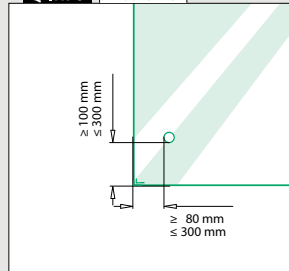

Q-INFO MOD 0741

MOD 5030 475

Zusätzliche Gummieinlagen für Glasadapter

Q-INFO MOD 0749

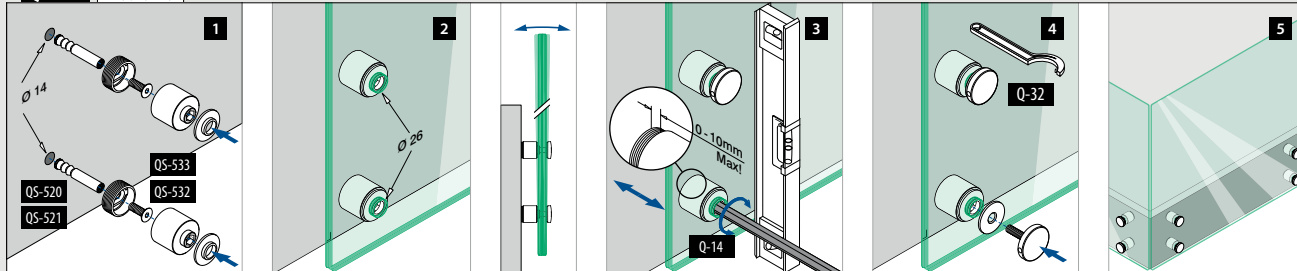

Q-INFO MOD 0741 / 0749

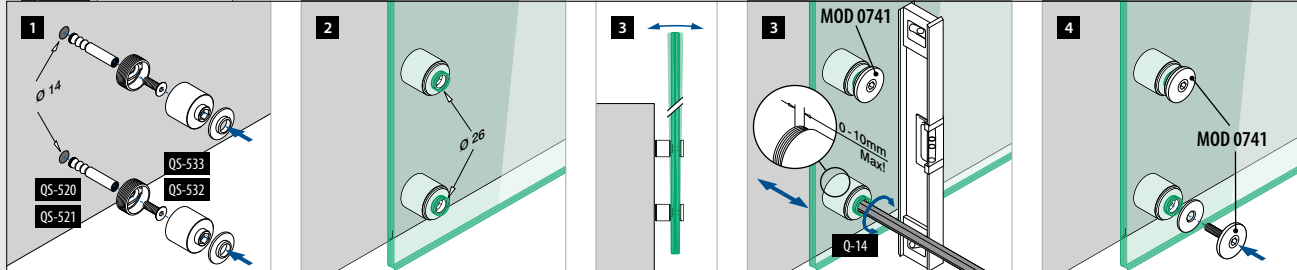



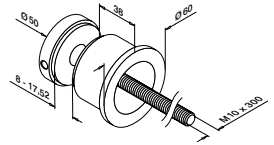
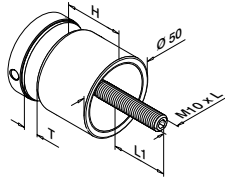

MOD 0747

V2A	304	Gebürstet				
INDOOR*			H	T	L	L1
	130747-010-12		10	8 - 17,52	50	11 - 20
	130747-020-12		20	8 - 25,52	70	13 - 31
	130747-030-12		30	8 - 25,52	80	13 - 31
	130747-040-12		40	8 - 17,52	80	11 - 22
	130747-050-12		50	8 - 17,52	90	11 - 22

V2A	304	Black Line				
INDOOR*						
NEW	130747-010-82		10	8 - 17,52	50	11 - 20
NEW	130747-030-82		30	8 - 25,52	80	13 - 31

V4A	316	Gebürstet				
OUTDOOR						
	140747-010-12		10	8 - 17,52	50	11 - 20
	140747-020-12		20	8 - 25,52	70	13 - 31
	140747-030-12		30	8 - 25,52	80	13 - 31
	140747-040-12		40	8 - 17,52	80	11 - 21
	140747-050-12		50	8 - 17,52	90	11 - 21

V4A	316	Black Line				
OUTDOOR						
NEW	140747-010-82		10	8 - 17,52	50	11 - 20
NEW	140747-030-82		30	8 - 25,52	80	13 - 31

V4A	316	Hochglanzpoliert				
OUTDOOR						
	140747-030-10		30	8 - 25,52	80	13 - 31

Zinkdruckguss		Roh				
INDOOR						
SELL OUT	100747-00		10	8 - 17,52	50	11 - 20

Zinkdruckguss		Edelstahleffekt				
OUTDOOR						
SELL OUT	100747-20		10	8 - 17,52	50	11 - 20



* Auch für Aussenanwendung geeignet bei entsprechenden Bedingungen.

SELL OUT Nur solange der Vorrat reicht.

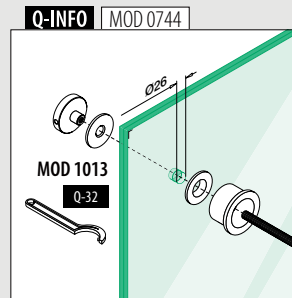
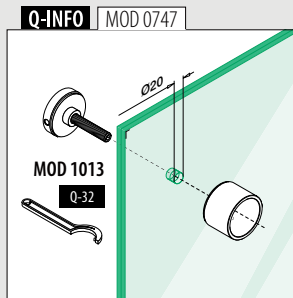
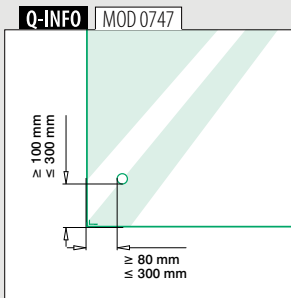

Q-INFO	304	316
10	12	82 RAL 9005
Hochglanzpoliert	Gebürstet	Pulverbeschichtet
		Schwarz, matt, strukturiert

Q-INFO	Zinkdruckguss
00	20
Roh	Edelstahleffekt

Q-INFO
MOD 1013 483
Hakenschlüssel

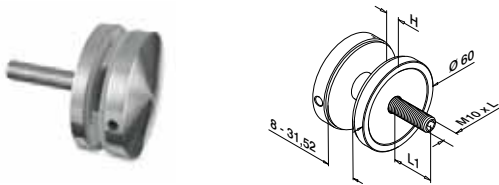

MOD 0745

V2A	304	Gebürstet	INDOOR*	H	L	L1	
			130745-010-12	10	70	17-41	2
V4A	316	Gebürstet	OUTDOOR				
			140745-010-12	10	70	17-41	2
V4A	316	Hochglanzpoliert	OUTDOOR				
SELL OUT			140745-010-10	10	70	17-41	2

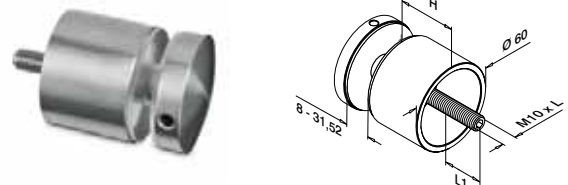

MOD 0745

V2A	304	Gebürstet	INDOOR*	H	L	L1	
			130745-030-12	30	90	17-41	2
			130745-050-12	50	110	17-41	2
V4A	316	Gebürstet	OUTDOOR				
			140745-030-12	30	90	17-41	2
			140745-050-12	50	110	17-41	2

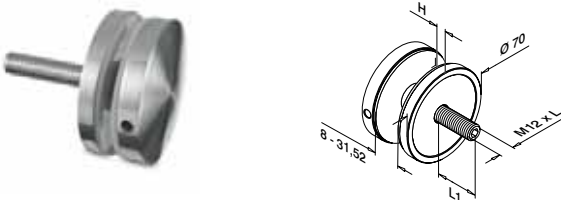

MOD 0748

V2A	304	Gebürstet	INDOOR*	H	L	L1	
			130748-010-12	10	70	17-41	2
V4A	316	Gebürstet	OUTDOOR				
			140748-010-12	10	70	17-41	2
V4A	316	Hochglanzpoliert	OUTDOOR				
SELL OUT			140748-010-10	10	70	17-41	2

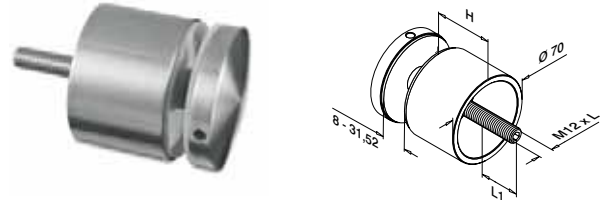

MOD 0748

V2A	304	Gebürstet	INDOOR*	H	L	L1	
			130748-030-12	30	90	17-41	2
			130748-040-12	40	100	17-41	2
V2A	304	Hochglanzpoliert	INDOOR*				
SELL OUT			130748-050-10	50	110	17-41	2
V4A	316	Gebürstet	OUTDOOR				
			140748-030-12	30	90	17-41	2
			140748-040-12	40	100	17-41	2



Q-INFO

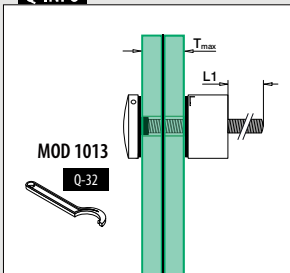

Q-INFO | MOD 0745-010

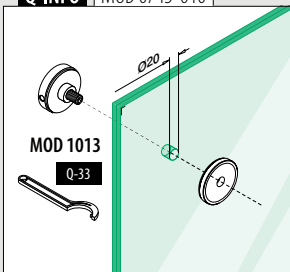

Q-INFO | MOD 0745-030 / 050

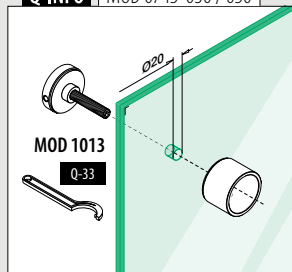

Q-INFO | MOD 0748-010

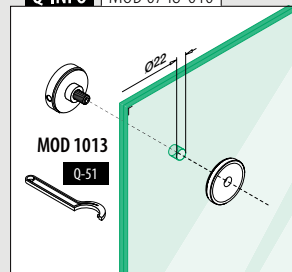

Q-INFO | MOD 0748-030 / 040 / 050

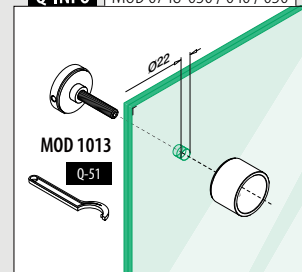

Geländerbasis

Blockförmige Glasadapter

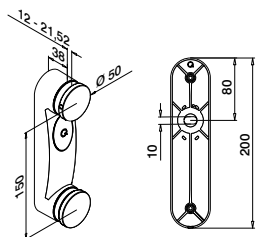

MOD 0762

V2A	304	Gebürstet		
INDOOR*				
130762-12		457 - 463		1

V4A	316	Gebürstet		
OUTDOOR				
140762-12		457 - 463		1



Internationaler Geschmacksmusterschutz

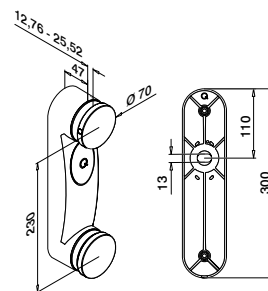

MOD 0760

V2A	304	Gebürstet		
INDOOR*				
130760		457 - 463		1

SELL OUT



Internationaler Geschmacksmusterschutz

Geländerbasis

Blockförmige Glasadapter

Neigung einstellbar

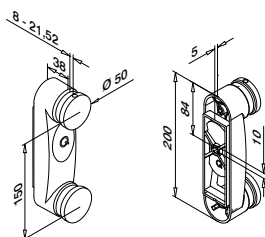

MOD 0766

V2A	304	Gebürstet		
INDOOR*				
130766		457 - 463		1



Internationaler Geschmacksmusterschutz

Q-INFO MOD 0766

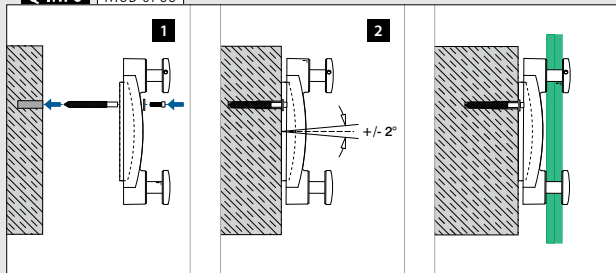

Q-INFO MOD 0762 / 0760

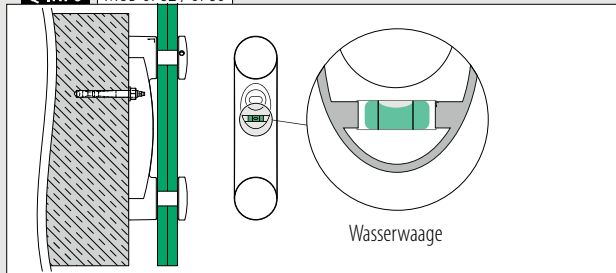

* Auch für Aussenanwendung geeignet bei entsprechenden Bedingungen.

SELL OUT Nur solange der Vorrat reicht.

Q-INFO MOD 0762 / 0766

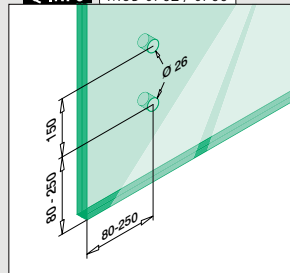

Q-INFO MOD 0760

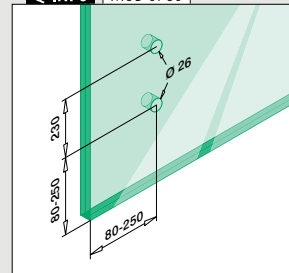



MOD 0760

Q-railing

Geländerbasis

Punktförmige Glasadapter

Quadratisch

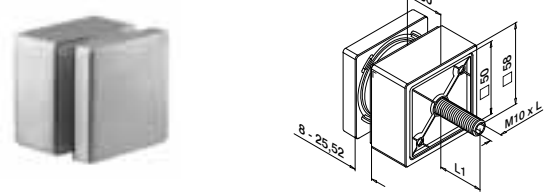
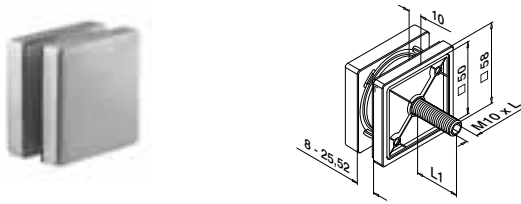

MOD 4747

MOD 4747

V4A	316	Gebürstet		
	OUTDOOR		L	L1
	144747-010-12		60	13 - 31

V4A	316	Gebürstet		
	OUTDOOR		L	L1
	144747-030-12		80	13 - 31



Internationaler Geschmacksmusterschutz

V4A	316	Hochglanzpoliert		
	OUTDOOR			
SELL OUT	144747-030-10		80	13 - 31



Internationaler Geschmacksmusterschutz

Geländerbasis

Blockförmige Glasadapter

Rechteckig

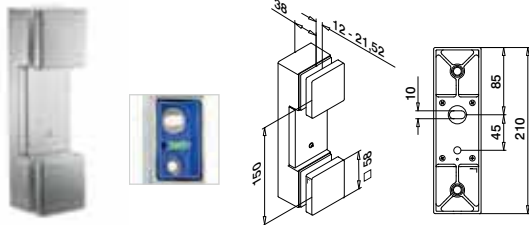

MOD 4762

V4A	316	Gebürstet		
	OUTDOOR			
	144762-12	457 - 463		1



Internationaler Geschmacksmusterschutz

Q-INFO 316

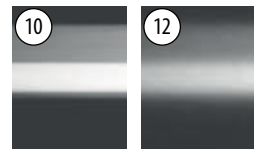

Hochglanzpoliert

Gebürstet

SELL OUT Nur solange der Vorrat reicht.

Q-INFO MOD 4762

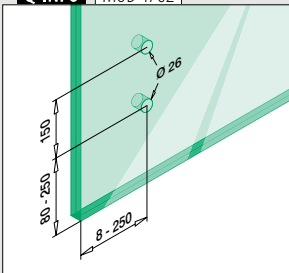

Q-INFO MOD 4747

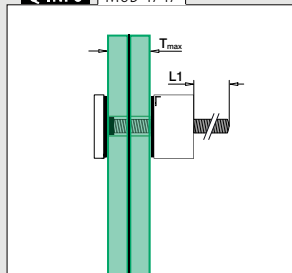

Q-INFO MOD 4747

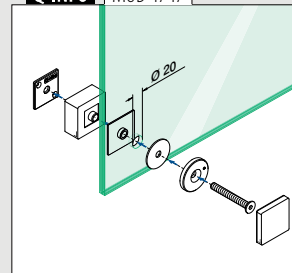

Q-INFO MOD 4747

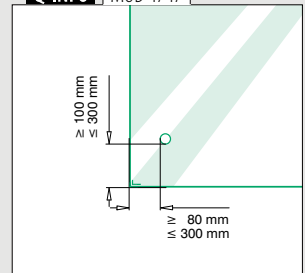

Q-INFO MOD 4762

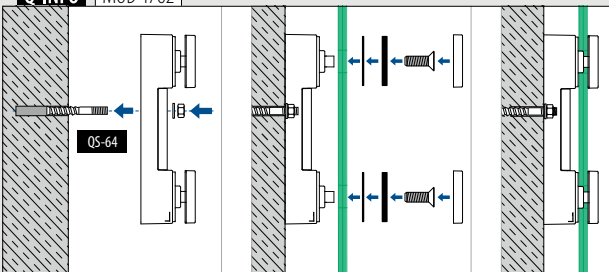

Q-INFO MOD 4762

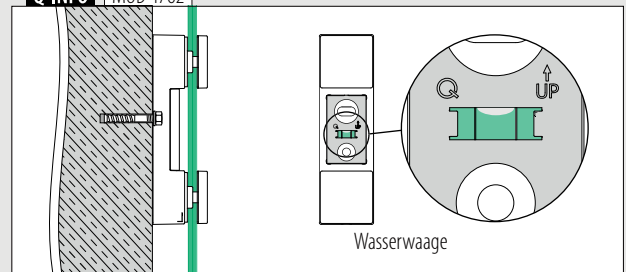

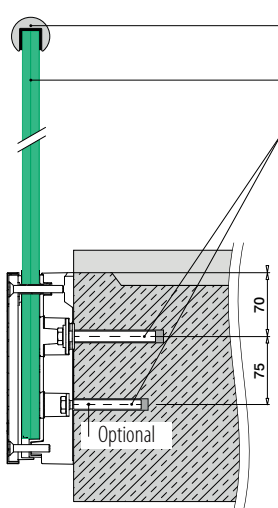

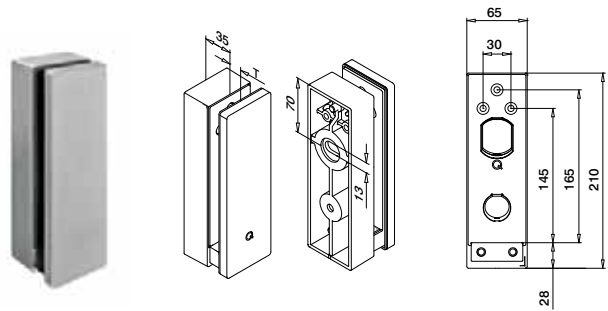

Glasleistenrohre: 169 - 185
Kantenschutz: 166 - 168
VSG gemäss Statik
Anker: 457 - 463

Bitte beachten Sie die Spezifikationen wie Befestigungs- und Glasmasse sowie Glastypen der jeweiligen Zertifikate und statischen Berechnungen.



MOD 0763

V2A	304	Gebürstet		
INDOOR*		T		
	130763-12	12 - 21,52	457 - 463	1
V4A	316	Gebürstet		
OUTDOOR				
	140763-12	12 - 21,52	457 - 463	1



International Design Model Protection

Nicht nach SIA-Norm geprüft, interne Prüfberichte stehen auf Anfrage zur Verfügung.

* Auch für Aussenanwendung geeignet bei entsprechenden Bedingungen.

Q-INFO

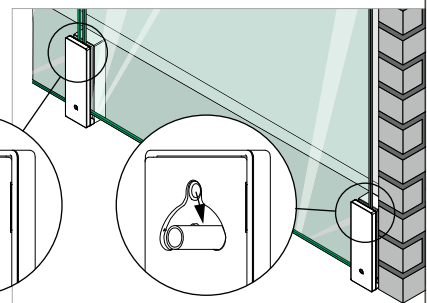
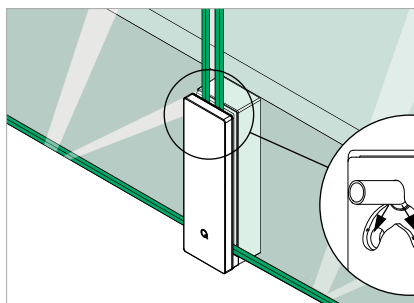
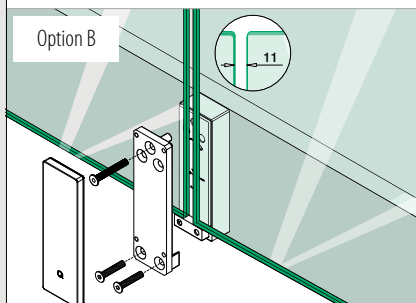
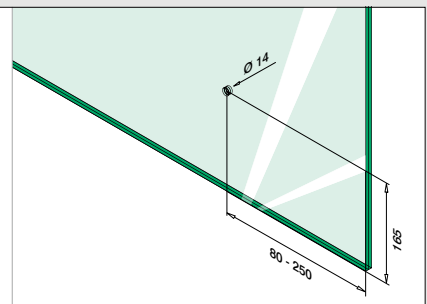
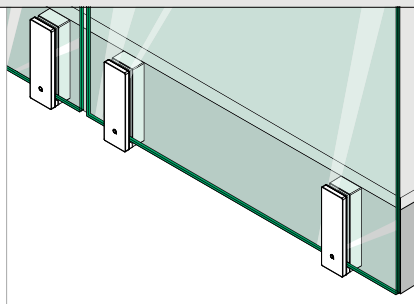
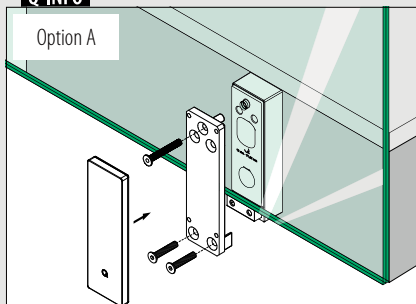



Q-GLASS

GLASSCHEIBEN FÜR GANZGLAS- GELÄNDERSYSTEME

Bestellen Sie die Glaselemente zeitgleich mit allen anderen Produkten für ihr Ganzglasgeländer

Massgefertigtes Glas

- Von monolithisches Glas bis hin zu 31,52 mm Verbundsicherheitsglas
- Optional mit matter, farbiger oder SentryGlas®-Folie
- Abgerundete Ecken und polierte Kanten auf Anfrage
- Optional mit vorgebohrten Löchern
- Gebogenes Glas

Glas in der Standardausführung

- Sofort ab Lager verfügbar
- Verbundsicherheitsglas
- 8,76 - 16,76 mm stark
(10 verschiedene Glasbreiten und 3 -höhen)
- Geschliffene, gesäumte und polierte Kanten
- Abgerundete Ecken

■ CE-Kennzeichnung ■ Hohe Qualität ■ Schnelle Lieferung ■ All-inclusive-Preise ■ Einfache Bestellung

Q-GLASS (Verbund-)Sicherheitsglas

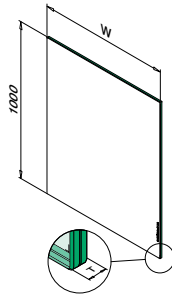

MOD 5017

(Verbund-)Sicherheitsglas ESG/VSG

SELL OUT	OUTDOOR	W	T
SELL OUT	195017-040-10	400	16,76
SELL OUT	195017-050-10	500	16,76
SELL OUT	195017-060-10	600	16,76
SELL OUT	195017-070-10	700	16,76
	195017-080-10	800	16,76
	195017-090-10	900	16,76
	195017-095-10	950	16,76
	195017-100-10	1000	16,76
	195017-100-11	1100	16,76
	195017-100-12	1200	16,76

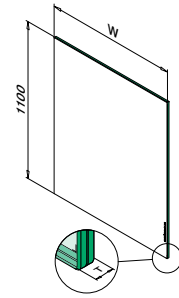

MOD 5017

(Verbund-)Sicherheitsglas ESG/VSG

SELL OUT	OUTDOOR	W	T
SELL OUT	195017-040-11	400	16,76
SELL OUT	195017-050-11	500	16,76
SELL OUT	195017-060-11	600	16,76
SELL OUT	195017-070-11	700	16,76
	195017-080-11	800	16,76
	195017-090-11	900	16,76
	195017-095-11	950	16,76
	195017-100-11	1000	16,76



Achtung: Q-glass entspricht nicht der für die Schweiz zugelassenen Glasqualität. Zur Auswahl des korrekten Glasaufbaus konsultieren Sie bitte das jeweilige Prüfzertifikat.

Für Glas auf Mass fragen Sie uns unverbindlich an:
sales@q-railing.ch

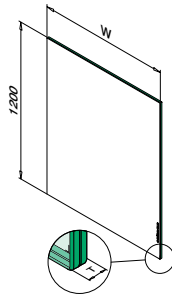

MOD 5017

(Verbund-)Sicherheitsglas ESG/VSG

SELL OUT	OUTDOOR	W	T
SELL OUT	195017-040-12	400	16,76
SELL OUT	195017-050-12	500	16,76
SELL OUT	195017-060-12	600	16,76
	195017-070-12	700	16,76
	195017-080-12	800	16,76
	195017-090-12	900	16,76
	195017-095-12	950	16,76
	195017-100-12	1000	16,76



Q-glass ist direkt ab Lager lieferbar.

SELL OUT Nur solange der Vorrat reicht.



Q-INFO

Berechnung

$$H \text{ (m)} \times W \text{ (m)} \times 2,5 \times T_g \text{ (mm)} = \text{kg}$$

Beispiel



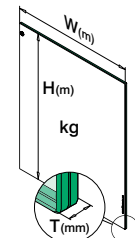

H	W	T
1,1 m	1,0 m	16 mm
1,1 x 1,0 x 2,5 x 16 = 44,00 kg		

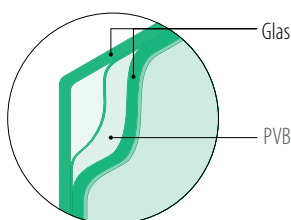
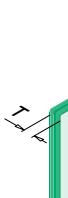

Q-INFO

(Verbund-)Sicherheitsglas



-  Geschliffene Kanten
-  Gesäumte Kanten
-  Polierte Kanten
-  Abgerundete Ecken

Füllungen

Glasverbinder

Ø 50

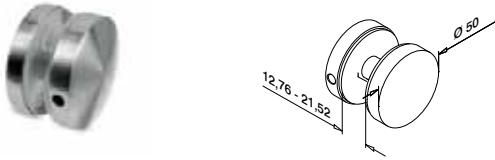

MOD 0742

V2A	304	Gebürstet	
INDOOR*			
130742-12			2
V4A	316	Gebürstet	
OUTDOOR			
140742-12			2
V4A	316	Hochglanzpoliert	
OUTDOOR			
140742-10			2



Füllungen

Gummieinlagen für MOD 2870 / 2890



4 Stück pro Glasverbinder

MOD 5028

Zubehör			
Für laminiertes Glas	T		
205028-17	16,76		8
205028-18	17,52		8
205028-21	20,76		8
205028-22	21,52		8



MOD 2870, 2880, 2890
Für T = 6 - 12,76 mm
446

Füllungen

Glasverbinder - für Glasstärken 16,76 - 21,52 mm

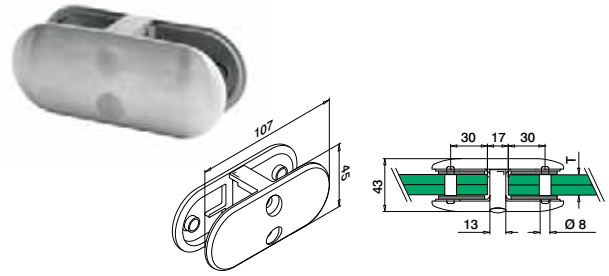

MOD 2870

V4A	316	Gebürstet	
OUTDOOR			
142870-22-12		Siehe T in MOD 5028	2



Internationaler Geschmacksmusterschutz



MOD 2890

V4A	316	Gebürstet	
OUTDOOR			
142890-22-12		Siehe T in MOD 5028	2



Internationaler Geschmacksmusterschutz

Zubehör

Sicherungsstifte

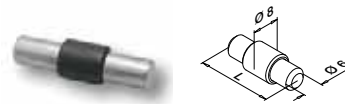

Optional verwendbar für MOD 2870 / 2890

MOD 5015

Zubehör			
	L		
205015-24	30		4

Q-INFO 316

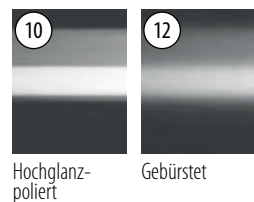

Hochglanzpoliert

Gebürstet

Q-INFO MOD 0742

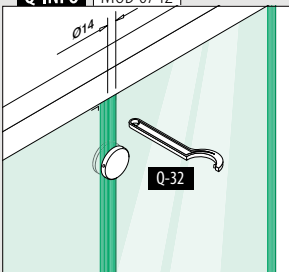

Q-INFO MOD 2870

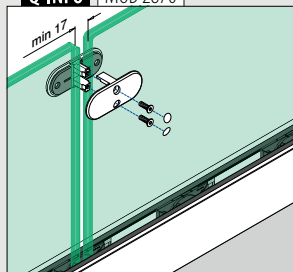

Q-INFO MOD 2890

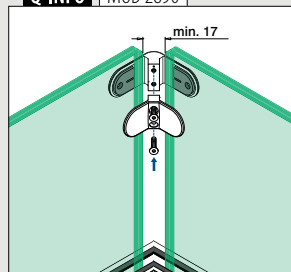

Q-INFO MOD 2870 / 2890

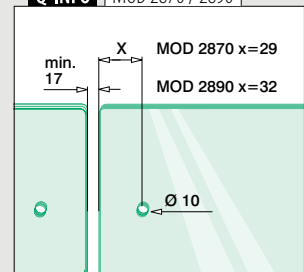

* Auch für Aussenanwendung geeignet bei entsprechenden Bedingungen.

Glasverbinder - für Glasstärken 16,76 - 21,52 mm

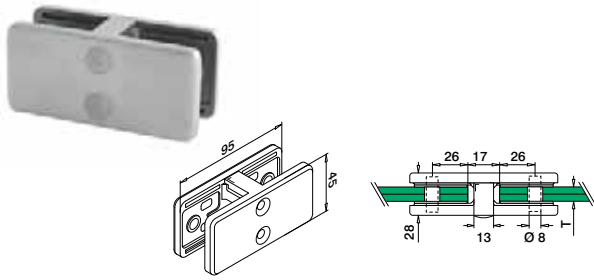

MOD 4270

V4A	316	Gebürstet		
	OUTDOOR		T	
144270-22-12	Siehe T in MOD 5042		2	



Internationaler Geschmacksmusterschutz

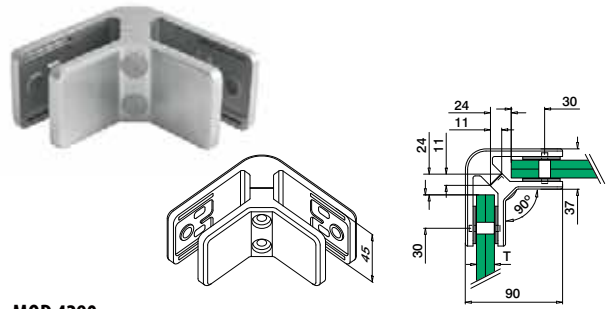

MOD 4290

V4A	316	Gebürstet		
	OUTDOOR		T	
144290-22-12	Siehe T in MOD 5042		2	



Internationaler Geschmacksmusterschutz

Gummieinlagen für MOD 4270 / 4290



4 Stück pro Glasverbinder

MOD 5042

	Zubehör			
Für laminiertes Glas	T			
205042-17	16,76	8		
205042-18	17,52	8		
205042-21	20,76	8		
205042-22	21,52	8		

Sicherungsstifte

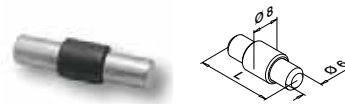

Optional verwendbar für MOD 4270 / 4290

MOD 5015

	Zubehör			
	L			
205015-24	30	4		



Q-INFO MOD 4270

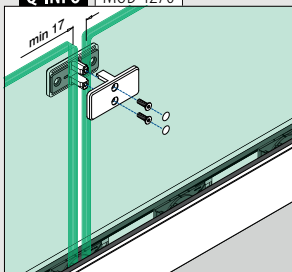

Q-INFO MOD 4290

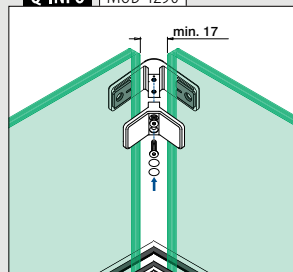

Q-INFO MOD 4270 / 4290

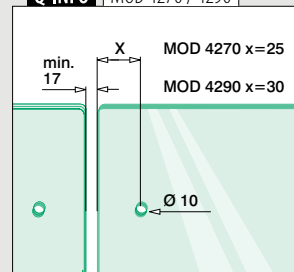

Zubehör

Glasverbinder

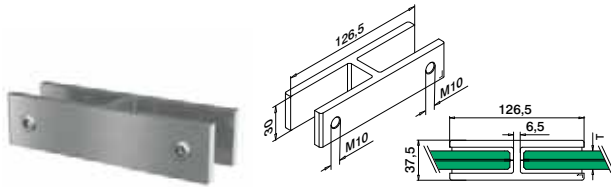

MOD 0291

Aluminium	Gebürstet		
OUTDOOR		T	
160291-22-18	Siehe T in MOD 5092		2

NEW

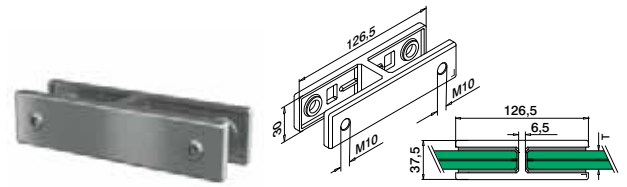

MOD 0291

V4A 316	Gebürstet		
OUTDOOR		T	
140291-22-12	Siehe T in MOD 5091		2

NEW

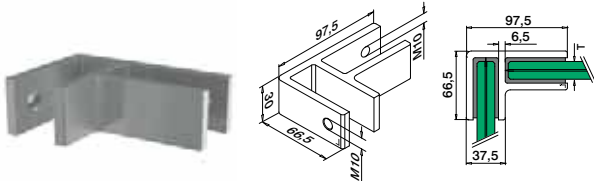

MOD 0292

Aluminium	Gebürstet		
OUTDOOR		T	
160292-22-18	Siehe T in MOD 5092		2

NEW

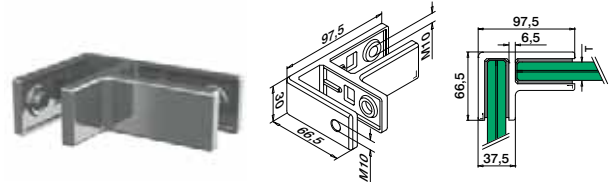

MOD 0292

V4A 316	Gebürstet		
OUTDOOR		T	
140292-22-12	Siehe T in MOD 5091		2

NEW

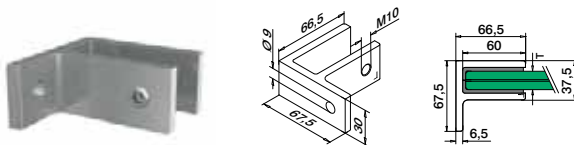

MOD 0293

Aluminium	Gebürstet		
OUTDOOR		T	
160293-22-18	Siehe T in MOD 5092		2

NEW

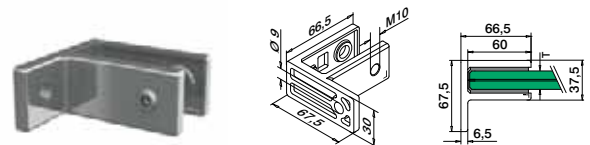

MOD 0293

V4A 316	Gebürstet		
OUTDOOR		T	
140293-22-12	Siehe T in MOD 5091		2

NEW

Füllungen

Gummieinlagen für MOD 0291 / 0292 / 0293 (Aluminium)



4 Stück für MOD 0291 und 0292
2 Stück MOD 0293
Inklusive Glasbefestigungsschrauben

MOD 5092

Zubehör			
Für laminiertes Glas	T		
205092-18	16,76 + 17,52		4
205092-22	20,76 + 21,52		4

NEW

Füllungen

Gummieinlagen für MOD 0291 / 0292 / 0293 (Edelstahl)



4 Stück für MOD 0291 und 0292
2 Stück MOD 0293
Inklusive Glasbefestigungsschrauben

MOD 5091

Zubehör			
Für laminiertes Glas	T		
205091-18	16,76 + 17,52		4
205091-22	20,76 + 21,52		4

NEW

Q-INFO MOD 0291

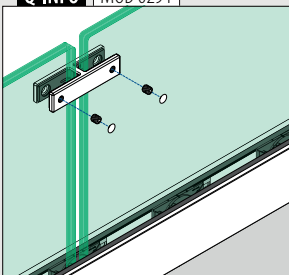

Q-INFO MOD 0292

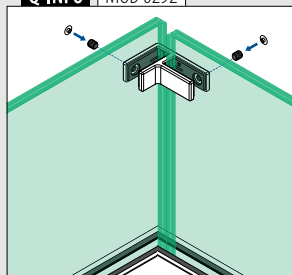

Q-INFO MOD 0293

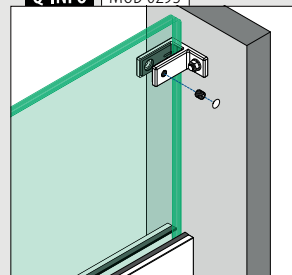



KANTEN-SCHUTZ

▣ 166



U-PROFILE

▣ 167, 168

GLASLEISTEN-ROHRE quadratisch / rechteckig

▣ 176



GLASLEISTEN-ROHRE rund

▣ 169



Q-railing

Kantenschutz

Kantenschutzprofile

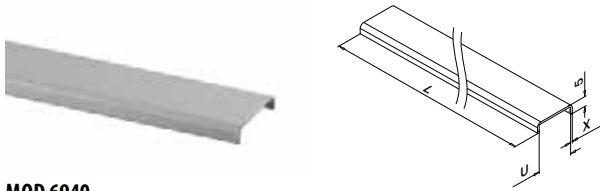

MOD 6940

Aluminium	Roh	U	Q	X	T	
166940-050-18-00		18,5	Q-98	1,5	16,76 - 17,52	L = 5 m
Aluminium	Gebürstet					
OUTDOOR						
166940-025-18-18		18,5	Q-98	1,5	16,76 - 17,52	L = 2,5 m
166940-025-22-18		22,5	Q-99	1,5	20,76 - 21,52	L = 2,5 m
166940-050-18-18		18,5	Q-98	1,5	16,76 - 17,52	L = 5 m
166940-050-22-18		22,5	Q-99	1,5	20,76 - 21,52	L = 5 m
Aluminium	Black Line					
OUTDOOR						
166940-025-18-82		18,5	Q-98	1,5	16,76 - 17,52	L = 2,5 m

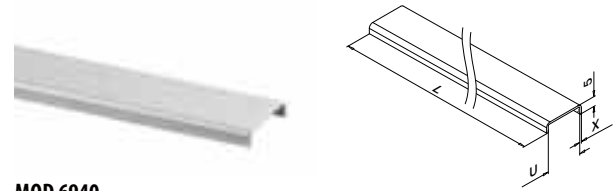

MOD 6940

V4A	316	Gebürstet				
OUTDOOR						
U	Q	X	T			
146940-025-18-12	18,5	Q-98	1	16,76 - 17,52	L = 2,5 m	
146940-025-22-12	22,5	Q-99	1	20,76 - 21,52	L = 2,5 m	
146940-050-14-12	14,5	Q-111	1	12,76 - 13,52	L = 5 m	
146940-050-18-12	18,5	Q-98	1	16,76 - 17,52	L = 5 m	
146940-050-22-12	22,5	Q-99	1	20,76 - 21,52	L = 5 m	
146940-050-26-12	26,5	Q-112	1	24,76 - 25,52	L = 5 m	

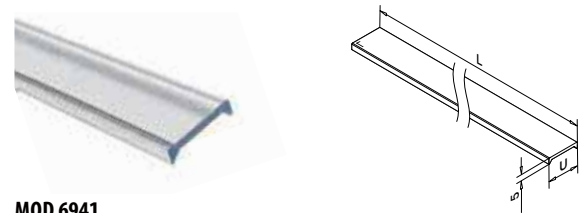

MOD 6941

Kunststoff	Transparent				
INDOOR					
U	Q	T			
156941-025-18-03	18,5	Q-122	16,76 - 17,52	L = 2,5 m	

NEW

Kantenschutz

Ecken

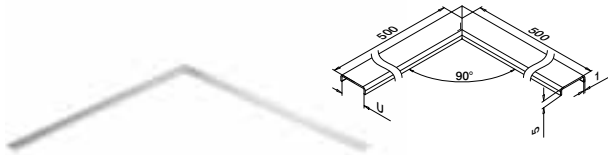

MOD 6340

V4A	316	Gebürstet			
OUTDOOR					
U	T				
146340-500-18	18,5	16,76 - 17,52	1		
146340-500-22	22,5	20,76 - 21,52	1		
146340-500-26	26,5	24,76 - 25,52	1		



Q-INFO Aluminium MOD 6940

00 Roh	18 Gebürstet, anodisiert	82 RAL 9005 Pulverbeschichtet Schwarz, matt, strukturiert
------------------	------------------------------------	--

Q-INFO

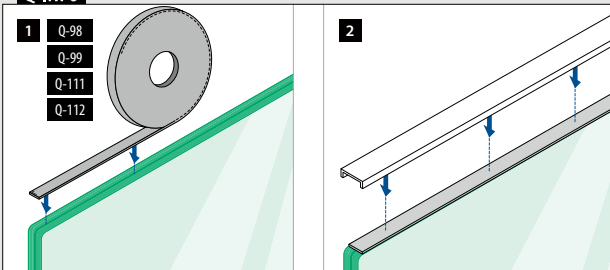

Q-INFO MOD 6940

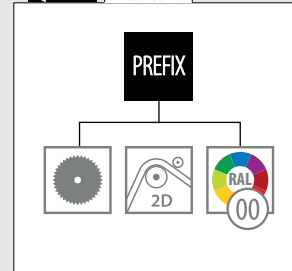

Q-INFO 316 MOD 6340 / 6940

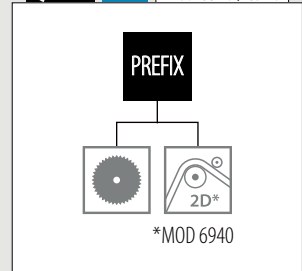

Q-INFO

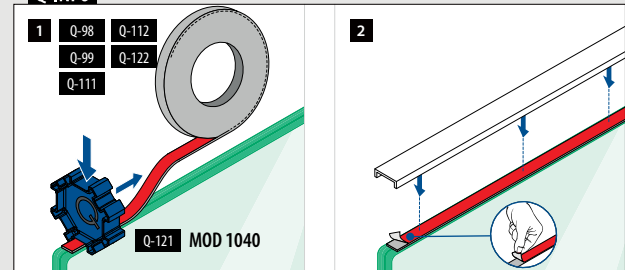

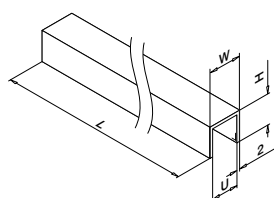

MOD 6944

Aluminium Gebürstet

OUTDOOR	U	Q	T	W	H	
166944-050-13-18	13,25	Q-111	12,76	17,25	15	L = 5 m
166944-050-18-18	18	Q-98	16,76 - 17,52	22	20	L = 5 m
166944-050-22-18	22	Q-99	21,52	26	20	L = 5 m

Aluminium Black Line

OUTDOOR	U	Q	T	W	H	
166944-050-13-82	13,25	Q-111	12,76	17,25	15	L = 5 m
166944-050-18-82	18	Q-98	16,76 - 17,52	22	20	L = 5 m
166944-050-22-82	22	Q-99	21,52	26	20	L = 5 m

NEW

NEW

NEW

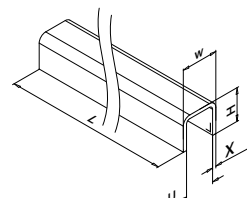

MOD 6960

V2A 304 Gebürstet

INDOOR*	U	X	T	W	H	
136960-050-24-12	24	3	8 - 21,52	30	27	L = 5 m

V4A 316 Gebürstet

OUTDOOR	U	X	T	W	H	
146960-050-24-12	24	3	8 - 21,52	30	27	L = 5 m
146960-050-34-12	34	3	8 - 31,52	40	37	L = 5 m

V4A 316 Black Line

OUTDOOR	U	X	T	W	H	
146960-050-24-82	24	3	8 - 21,52	30	27	L = 5 m

NEW

MOD 6961

V2A 304 Gebürstet

INDOOR*	U	X	T	W	H	
136961-050-24-12	24	2	8 - 21,52	28	26	L = 5 m

V4A 316 Gebürstet

OUTDOOR	U	X	T	W	H	
146961-050-24-12	24	2	8 - 21,52	28	26	L = 5 m
146961-050-34-12	34	2	8 - 31,52	38	36	L = 5 m



* Auch für Aussenanwendung geeignet bei entsprechenden Bedingungen.

Q-INFO MOD 6944

PREFIX



Q-INFO Aluminium

18

82 RAL 9005

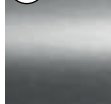
Gebürstet,
anodisiertSchwarz, matt,
strukturiert

Q-INFO MOD 6960 / 6961

PREFIX



*MOD 6961

Q-INFO 304 316

12

82 RAL 9005



Gebürstet

Schwarz, matt,
strukturiert

Q-INFO

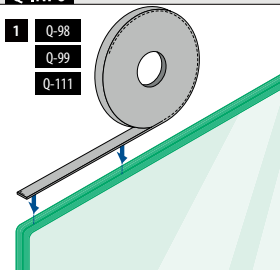
1 Q-98
Q-99
Q-111

2

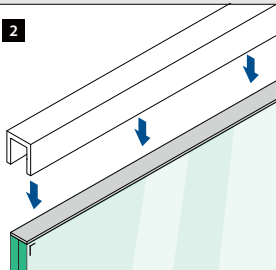

Q-INFO MOD 6960 / 6961

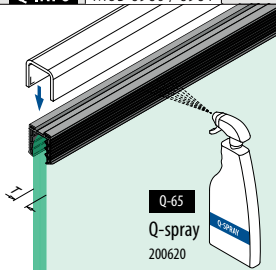
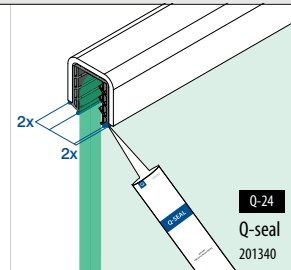
Q-65
Q-spray
200620Q-24
Q-seal
201340

U-Profile

Ecken

Quadratisch



MOD 6362

V4A	316	Gebürstet						
OUTDOOR			U	X	T	W	H	
146362-24-12	24	3	8 - 21,52	30	27	1		
146362-34-12	34	3	8 - 31,52	40	37	1		

V4A	316	Black Line						
OUTDOOR			U	X	T	W	H	
NEW 146362-24-82	24	3	8 - 21,52	30	27	1		

MOD 6361

V4A	316	Gebürstet						
OUTDOOR			U	X	T	W	H	
146361-24	24	2	8 - 21,52	28	26	1		
146361-34	34	2	8 - 31,52	38	36	1		

U-Profile

Endkappen

Quadratisch

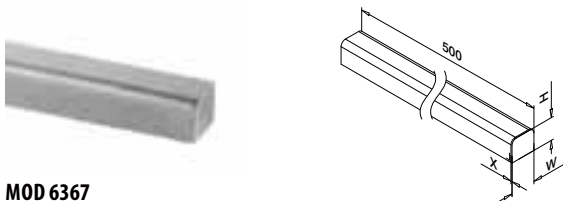

MOD 6367

V4A	316	Gebürstet						
OUTDOOR			U	X	T	W	H	
146367-24-12	24	3	8 - 21,52	30	27	1		
146367-34-12	34	3	8 - 31,52	40	37	1		

V4A	316	Black Line						
OUTDOOR			U	X	T	W	H	
NEW 146367-24-82	24	3	8 - 21,52	30	27	1		

MOD 6366

V4A	316	Gebürstet						
OUTDOOR			U	X	T	W	H	
146366-24	24	2	8 - 21,52	28	26	1		
146366-34	34	2	8 - 31,52	38	36	1		

U-Profile

Gummieinlagen



MOD 5124

Zubehör

U = 24 mm

Für monolithisches Glas	T	
205124-050-08	8 - 10	L = 5 m
205124-050-11	12	L = 5 m
205124-050-15	15	L = 5 m
205124-050-19	19	L = 5 m

Für laminiertes Glas

205124-050-08	8,76 - 10,76	L = 5 m
205124-050-11	11,52 - 13,52	L = 5 m
205124-050-17	16,76 - 17,52	L = 5 m
NEW 205124-050-92	20,76 - 21,52	L = 5 m

MOD 5134

Zubehör

U = 34 mm

Für monolithisches Glas	T	
205134-050-08	8 - 10	L = 5 m
205134-050-11	12	L = 5 m
205134-050-19	19	L = 5 m

Für laminiertes Glas

205134-050-08	8,76 - 10,76	L = 5 m
205134-050-11	11,52 - 13,52	L = 5 m
205134-050-17	16,76 - 17,52	L = 5 m
205134-050-22	20,76 - 21,52	L = 5 m
205134-050-24	24,76 - 25,52	L = 5 m
205134-050-32	31,52	L = 5 m

Q-INFO 304 316

12

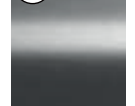

Gebürstet

82 RAL 9005



Schwarz, matt, strukturiert

Q-INFO MOD 6366 / 6367

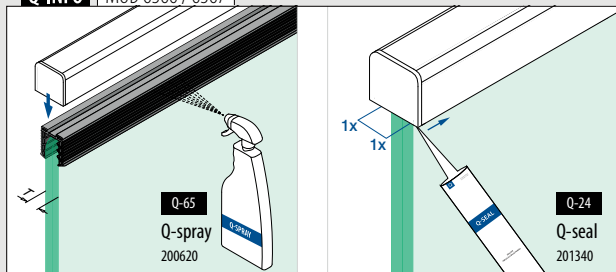

Q-INFO MOD 6361 / 6362

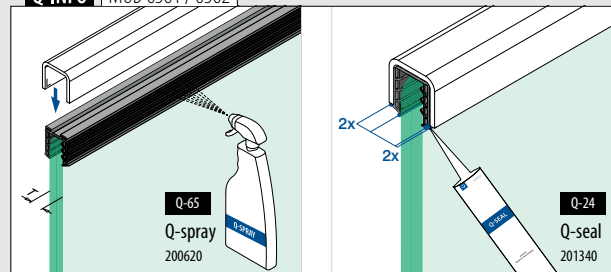

Glasleistenrohre

Glasleistenrohre

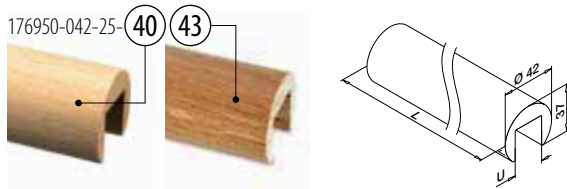

MOD 6950

Buche	Natur lackiert		
INDOOR	U		
176950-042-25-40	24		L = 2,5 m
Eiche	Natur lackiert		
INDOOR			
176950-042-25-43	24		L = 2,5 m

PREFIX

Glasleistenrohre

Verbinder



MOD 6791

V2A	304	Gebürstet		
INDOOR	Ø			
176791-042	42,0	QS-49 471		2



Glasleistenrohre

Endkappen



MOD 6729

V2A	304	Gebürstet		
INDOOR				
176729-042		QS-49 471		2



Holz ist ein Naturprodukt. Farbabweichungen sind möglich.

Glasleistenrohre

Gummieinlagen



MOD 5124

Zubehör		
U = 24 mm		
Für monolithisches Glas	T	
205124-050-08	8 - 10	L = 5 m
205124-050-11	12	L = 5 m
205124-050-15	15	L = 5 m
205124-050-19	19	L = 5 m

Für laminiertes Glas

205124-050-08	8,76 - 10,76	L = 5 m
205124-050-11	11,52 - 13,52	L = 5 m
205124-050-17	16,76 - 17,52	L = 5 m
NEW 205124-050-92	20,76 - 21,52	L = 5 m

Zubehör

Bohrschablone



MOD 1024

Zubehör	Q	
201024-042	Q-20	1

Q-INFO MOD 6950

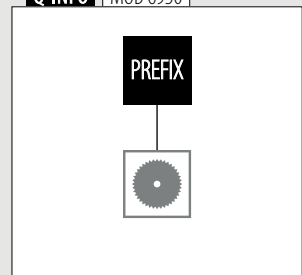

Q-INFO MOD 6950

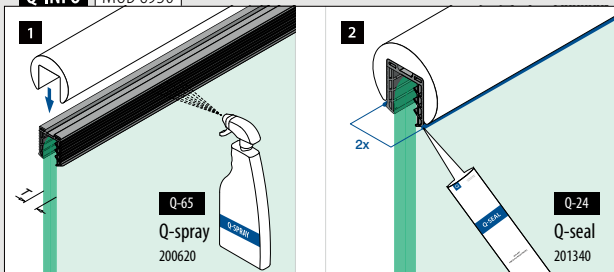

Q-INFO MOD 6729 / 1024

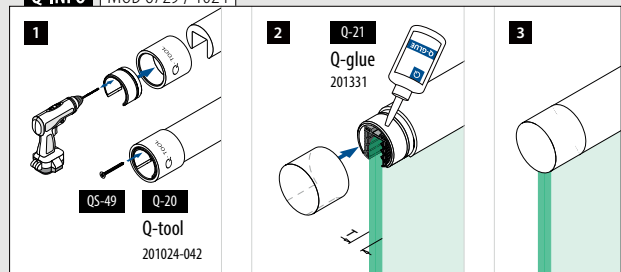

Glasleistenrohre

Glasleistenrohre

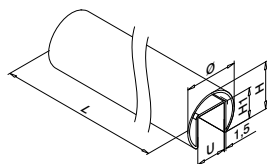

MOD 6920

Ø 42,4 mm

V2A	304	Gebürstet				
	INDOOR*	U	H	H1		
SELL OUT	136920-042-25-12	24	37	24		L = 2,5 m
	136920-042-50-12	24	37	24		L = 5 m

V4A	316	Gebürstet				
	OUTDOOR					
	146920-042-50-12	24	37	24		L = 5 m

V4A	316	Hochglanzpoliert				
	OUTDOOR					
	146920-042-50-10	24	37	24		L = 5 m

Ø 48,3 mm

V2A	304	Gebürstet				
	INDOOR*	U	H	H1		
	136920-048-50-12	27	42,6	30		L = 5 m

V4A	316	Gebürstet				
	OUTDOOR					
	146920-048-50-12	27	42,6	30		L = 5 m

Ø 60,3 mm

V2A	304	Gebürstet				
	INDOOR*	U	H	H1		
	136920-060-50-12	34	53	34		L = 5 m

V4A	316	Gebürstet				
	OUTDOOR					
	146920-060-50-12	34	53	34		L = 5 m



Glasleistenrohre

Gummieinlagen

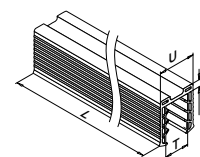

MOD 5124

Zubehör

U = 24 mm

Für monolithisches Glas	T	
205124-050-08	8 - 10	L = 5 m
205124-050-11	12	L = 5 m
205124-050-15	15	L = 5 m
205124-050-19	19	L = 5 m

205124-250-08	8 - 10	L = 25 m
205124-250-11	12	L = 25 m
205124-250-15	15	L = 25 m
205124-250-19	19	L = 25 m

Für laminiertes Glas

205124-050-08	8,76 - 10,76	L = 5 m
205124-050-11	11,52 - 13,52	L = 5 m
205124-050-17	16,76 - 17,52	L = 5 m
NEW 205124-050-92	20,76 - 21,52	L = 5 m

205124-250-08	8,76 - 10,76	L = 25 m
205124-250-11	11,52 - 13,52	L = 25 m
205124-250-17	16,76 - 17,52	L = 25 m
NEW 205124-250-92	20,76 - 21,52	L = 25 m

MOD 5127

Zubehör

U = 27 mm

Für monolithisches Glas	T	
205127-050-08	8 - 10	L = 5 m
205127-050-11	12	L = 5 m
205127-050-15	15	L = 5 m
205127-050-19	19	L = 5 m

Für laminiertes Glas

205127-050-08	8,76 - 10,76	L = 5 m
205127-050-11	11,52 - 13,52	L = 5 m
205127-050-15	16,76 - 17,52	L = 5 m
205127-050-22	20,76 - 21,52	L = 5 m
205127-050-24	24,76 - 25,52	L = 5 m

MOD 5134

Zubehör

U = 34 mm

Für monolithisches Glas	T	
205134-050-08	8 - 10	L = 5 m
205134-050-11	12	L = 5 m
205134-050-19	15	L = 5 m

Für laminiertes Glas

205134-050-08	8,76 - 10,76	L = 5 m
205134-050-11	11,52 - 13,52	L = 5 m
205134-050-17	16,76 - 17,52	L = 5 m
205134-050-22	20,76 - 21,52	L = 5 m
205134-050-24	24,76 - 25,52	L = 5 m
205134-050-32	31,52	L = 5 m

* Auch für Aussenanwendung geeignet bei entsprechenden Bedingungen.

SELL OUT Nur solange der Vorrat reicht.

Q-INFO MOD 6920

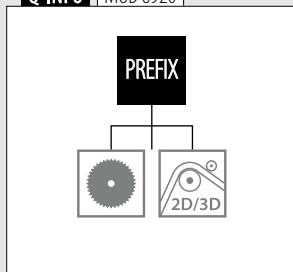

Q-INFO 316



Verbinder

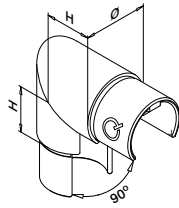

MOD 6303

V2A	304	Gebürstet			
INDOOR*		Ø	H	☐	
	136303-042-12	42,4 x 1,5	30	2	

V4A	316	Gebürstet			
OUTDOOR		Ø	H	☐	
	146303-042-12	42,4 x 1,5	30	2	

MOD 6792 - EASY HIT®

V2A	304	Roh		
INDOOR*		Für Rohr Ø	☐	
	136792-042	42,4 x 1,5	2	
	136792-048	48,3 x 1,5	2	

V4A	316	Roh		
OUTDOOR		Für Rohr Ø	☐	
	146792-042	42,4 x 1,5	2	
	146792-048	48,3 x 1,5	2	
	146792-060	60,3 x 1,5	2	

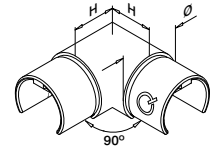

MOD 6313

V2A	304	Gebürstet			
INDOOR*		Ø	H	☐	
	136313-042-12	42,4 x 1,5	30	2	
	136313-048-12	48,3 x 1,5	35	2	
SELL OUT	136313-060-12	60,3 x 1,5	40	2	

V4A	316	Gebürstet			
OUTDOOR		Ø	H	☐	
	146313-042-12	42,4 x 1,5	30	2	
	146313-048-12	48,3 x 1,5	35	2	
	146313-060-12	60,3 x 1,5	40	2	

V4A	316	Hochglanzpoliert			
OUTDOOR		Ø	H	☐	
	146313-042-10	42,4 x 1,5	30	2	

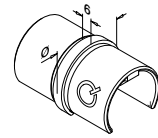

MOD 6790

V2A	304	Gebürstet		
INDOOR*		Für Rohr Ø	☐	
	136790-042-12	42,4 x 1,5	2	
	136790-048-12	48,3 x 1,5	2	
SELL OUT	136790-060-12	60,3 x 1,5	2	

V4A	316	Gebürstet		
OUTDOOR		Für Rohr Ø	☐	
	146790-042-12	42,4 x 1,5	2	
	146790-048-12	48,3 x 1,5	2	

V4A	316	Hochglanzpoliert		
OUTDOOR		Für Rohr Ø	☐	
	146790-042-10	42,4 x 1,5	2	



Q-INFO | MOD 6792

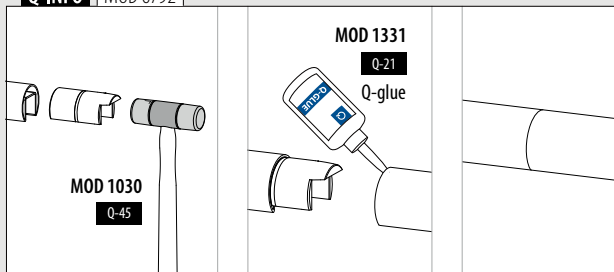



25–55°
Abwärts

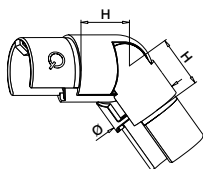

MOD 6302

V2A	304	Gebürstet			
INDOOR*		Ø	H		
	136302-042-02-12	42,4 x 1,5	30	2	
	136302-048-02-12	48,3 x 1,5	35	2	
SELL OUT	136302-060-02-12	60,3 x 1,5	40	2	
V4A	316	Gebürstet			
OUTDOOR					
	146302-042-02-12	42,4 x 1,5	30	2	
	146302-048-02-12	48,3 x 1,5	35	2	
	146302-060-02-12	60,3 x 1,5	40	2	
V4A	316	Hochglanzpoliert			
OUTDOOR					
	146302-042-02-10	42,4 x 1,5	30	2	



25–55°
Aufwärts

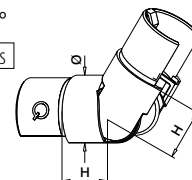

MOD 6302

V2A	304	Gebürstet			
INDOOR*		Ø	H		
	136302-042-01-12	42,4 x 1,5	30	2	
	136302-048-01-12	48,3 x 1,5	35	2	
SELL OUT	136302-060-01-12	60,3 x 1,5	40	2	
V4A	316	Gebürstet			
OUTDOOR					
	146302-042-01-12	42,4 x 1,5	30	2	
	146302-048-01-12	48,3 x 1,5	35	2	
	146302-060-01-12	60,3 x 1,5	40	2	
V4A	316	Hochglanzpoliert			
OUTDOOR					
	146302-042-01-10	42,4 x 1,5	30	2	



+40° / -95°
Horizontal

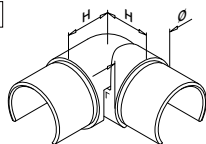

MOD 6312

V2A	304	Gebürstet			
INDOOR*		Ø	H		
	136312-042-12	42,4 x 1,5	27	2	
	136312-048-12	48,3 x 1,5	30	2	
V4A	316	Gebürstet			
OUTDOOR					
	146312-042-12	42,4 x 1,5	27	2	
	146312-048-12	48,3 x 1,5	30	2	

NEW



Q-INFO 316

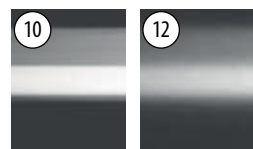

Hochglanzpoliert

Gebürstet

* Auch für Aussenanwendung geeignet bei entsprechenden Bedingungen.



Nur solange der Vorrat reicht.

Glasleistenrohre

Glasleistenrohr/Rohr-Verbinder

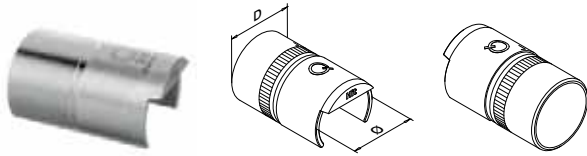

MOD 5793 - EASY HIT®

V4A	316	Roh			
OUTDOOR		Für Rohr D	Für Rohr Ø		
145793-042		42,4 x 2,0	42,4 x 1,5	2	
145793-048		48,3 x 2,0	48,3 x 1,5	2	



Internationaler Geschmacksmusterschutz

Glasleistenrohre

Endbögen



MOD 6738

V2A	304	Gebürstet			
INDOOR*		Für Rohr Ø	L		
136738-042-12		42,4 x 1,5	60	2	
136738-048-12		48,3 x 1,5	65	2	

V4A	316	Gebürstet			
OUTDOOR		Für Rohr Ø	L		
146738-042-12		42,4 x 1,5	60	2	



Internationaler Geschmacksmusterschutz

Glasleistenrohre

Endkappen



MOD 6732

V2A	304	Gebürstet			
INDOOR*		Für Rohr Ø			
136732-042-12		42,4 x 1,5	2		
136732-048-12		48,3 x 1,5	2		

SELL OUT	136732-060-12	60,3 x 1,5	2		
----------	---------------	------------	---	--	--

V4A	316	Gebürstet			
OUTDOOR		Für Rohr Ø			
146732-042-12		42,4 x 1,5	2		
146732-048-12		48,3 x 1,5	2		
146732-060-12		60,3 x 1,5	2		

V4A	316	Hochglanzpoliert			
OUTDOOR		Für Rohr Ø			
146732-042-10		42,4 x 1,5	2		



Glasleistenrohre

Wandflansche

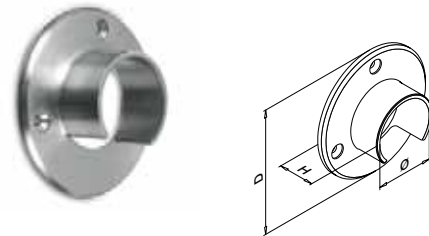

MOD 6505

V2A	304	Gebürstet					
INDOOR*		Für Ø	D	H			
136505-042-12		42,4	90	30	QS-5	471	2
136505-048-12		48,3	95	35	QS-5	471	2

SELL OUT	136505-060-12	60,3	107	35	QS-5	471	2
----------	---------------	------	-----	----	------	-----	---

V4A	316	Gebürstet					
OUTDOOR		Für Ø	D	H			
146505-042-12		42,4	90	30	QS-6	471	2
146505-048-12		48,3	95	35	QS-6	471	2
146505-060-12		60,3	107	35	QS-6	471	2

V4A	316	Hochglanzpoliert					
OUTDOOR		Für Ø	D	H			
146505-042-10		42,4	90	30	QS-6	471	2



Q-INFO MOD 6738

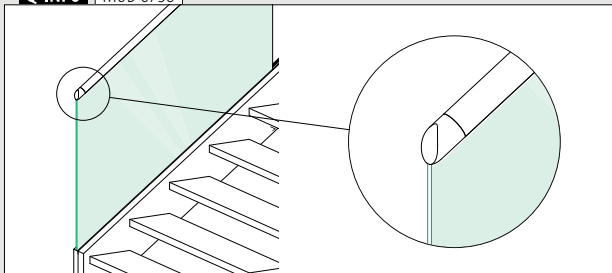

Q-INFO MOD 5793

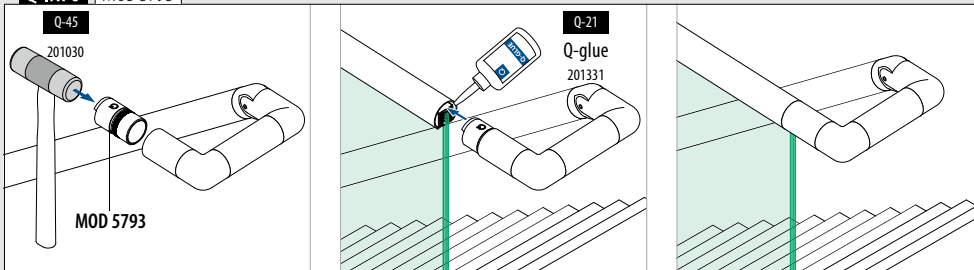

Glasleistenrohre

Glasleistenrohre

166920-042-50-00 18

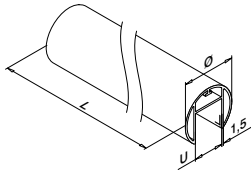

MOD 6920

Aluminium	Roh	U	Ø	
166920-042-50-00		24	42,4	L = 5 m
Aluminium	Gebürstet			
OUTDOOR				
166920-042-50-18		24	42,4	L = 5 m



Internationaler Geschmacksmusterschutz

Glasleistenrohre

Ecken

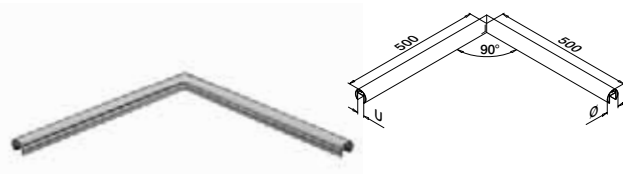

MOD 6320

Aluminium	Roh	U	Ø	
166320-042-00		24	42,4 x 1,5	1
Aluminium	Gebürstet			
OUTDOOR				
166320-042-18		24	42,4 x 1,5	1

Internationaler Geschmacksmusterschutz

Glasleistenrohre

Endkappen

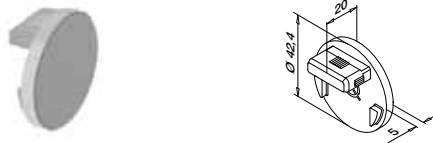

MOD 6732 - EASY HIT®

Aluminium	Roh	Für Ø	
166732-042-00		42,4 x 1,5	2
Aluminium	Gebürstet		
OUTDOOR			
166732-042-18		42,4 x 1,5	2



Internationaler Geschmacksmusterschutz

Glasleistenrohre

Gummieinlagen

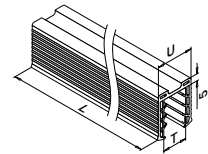

MOD 5124

Zubehör

U = 24 mm

Für monolithisches Glas	T	
205124-050-08	8 - 10	L = 5 m
205124-050-11	12	L = 5 m
205124-050-15	15	L = 5 m
205124-050-19	19	L = 5 m
205124-250-08	8 - 10	L = 25 m
205124-250-11	12	L = 25 m
205124-250-15	15	L = 25 m
205124-250-19	19	L = 25 m

Für laminiertes Glas

205124-050-08	8,76 - 10,76	L = 5 m
205124-050-11	11,52 - 13,52	L = 5 m
205124-050-17	16,76 - 17,52	L = 5 m
NEW 205124-050-92	20,76 - 21,52	L = 5 m
205124-250-08	8,76 - 10,76	L = 25 m
205124-250-11	11,52 - 13,52	L = 25 m
205124-250-17	16,76 - 17,52	L = 25 m
NEW 205124-250-92	20,76 - 21,52	L = 25 m

Q-INFO MOD 6920

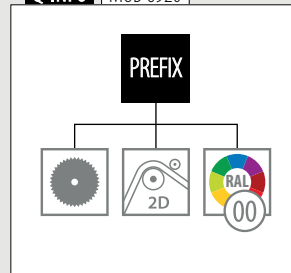

Q-INFO Aluminium



Q-INFO MOD 6920 / 5124 / 6732

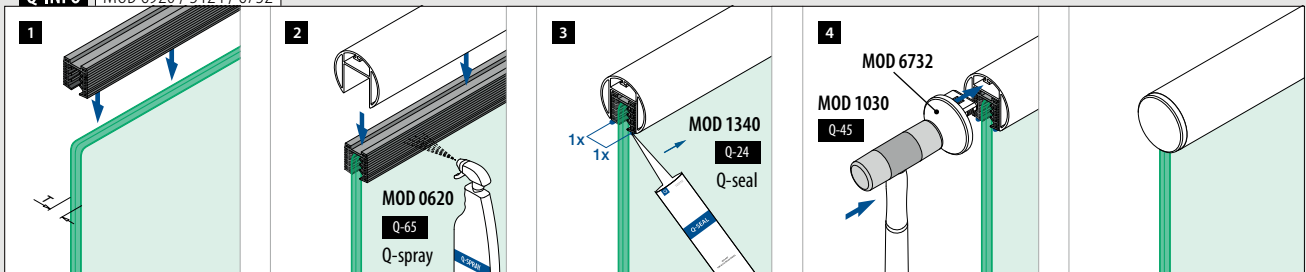

Verbinder

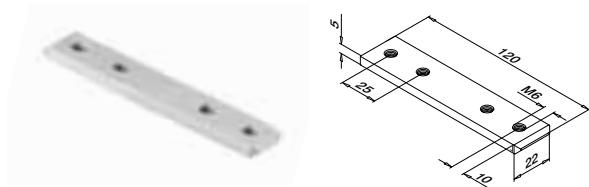

MOD 6795

Aluminium	Roh		
166795-339	QS-261	472	2

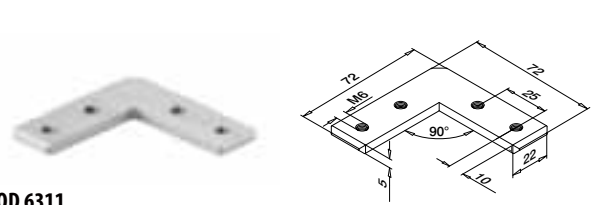

MOD 6311

Aluminium	Roh		
166311-339	QS-261	472	2

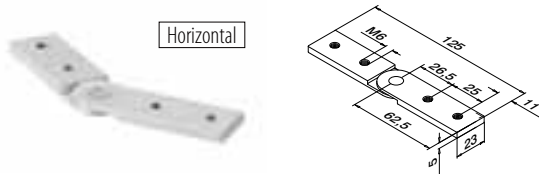

MOD 6797

Aluminium	Roh		
166797	QS-261	472	2

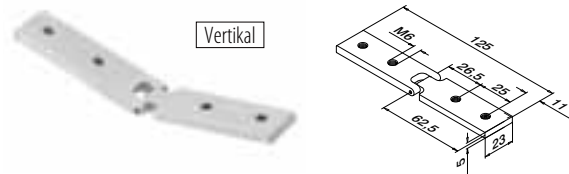

MOD 6798

Aluminium	Roh		
166798	QS-261	472	2

Q-INFO MOD 6311

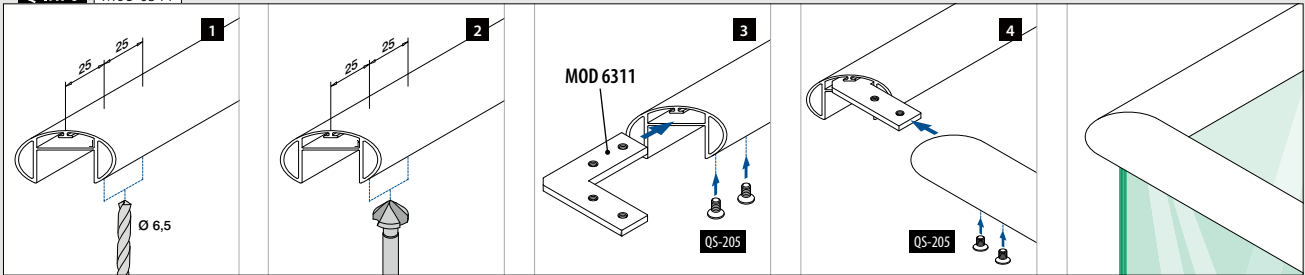

Q-INFO MOD 6797

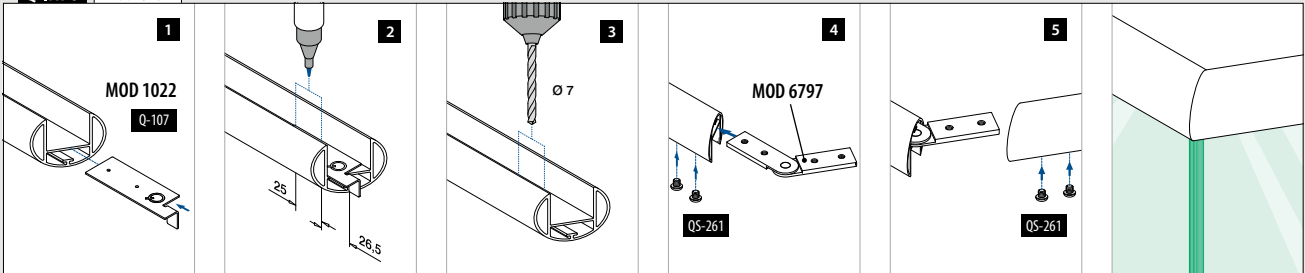

Q-INFO MOD 6798

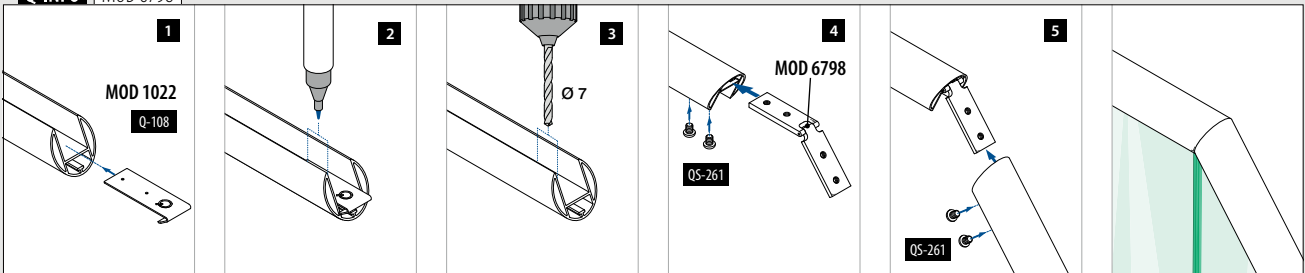

Q-INFO MOD 6798

Nach oben

Schneiden	45°	40°	35°	30°	25°	20°	15°	10°	5°	0°
Aussenwinkel	90°	100°	110°	120°	130°	140°	150°	160°	170°	180°
Abstand zum Rand (x)	30,5	30,0	29,5	29,0	28,5	28,0	27,5	27,0	27,0	26,5

Nach unten

Schneiden	0°	5°	10°	15°	20°	25°	30°	35°	40°	45°
Innenwinkel	180°	170°	160°	150°	140°	130°	120°	110°	100°	90°
Abstand zum Rand (x)	26,5	26,5	26,0	26,0	25,5	25,5	25,0	24,5	24,5	24,0

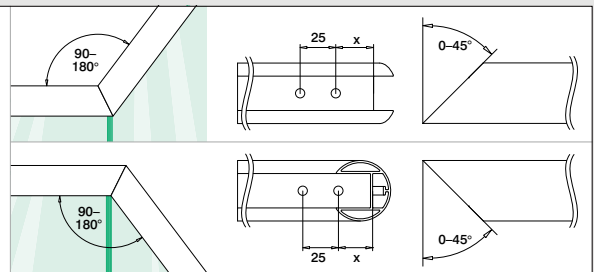

Glasleistenrohre

Glasleistenrohre

Quadratisch

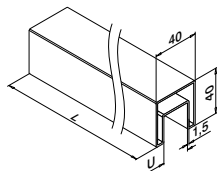

MOD 6924

V2A	304	Gebürstet			
INDOOR*			U	<input type="checkbox"/>	
SELL OUT	136924-040-25-12	24	40 x 40	L = 2,5 m	
	136924-040-50-12	24	40 x 40	L = 5 m	
V4A	316	Gebürstet			
OUTDOOR					
	146924-040-25-12	24	40 x 40	L = 2,5 m	
	146924-040-50-12	24	40 x 40	L = 5 m	



Glasleistenrohre

Gummieinlagen

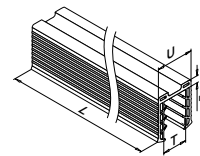

MOD 5124

Zubehör		
U = 24 mm		
Für monolithisches Glas		T
205124-050-08	8 - 10	L = 5 m
205124-050-11	12	L = 5 m
205124-050-15	15	L = 5 m
205124-050-19	19	L = 5 m
<hr/>		
205124-250-08	8 - 10	L = 25 m
205124-250-11	12	L = 25 m
205124-250-15	15	L = 25 m
205124-250-19	19	L = 25 m
<hr/>		
Für laminiertes Glas		
205124-050-08	8,76 - 10,76	L = 5 m
205124-050-11	11,52 - 13,52	L = 5 m
205124-050-17	16,76 - 17,52	L = 5 m
NEW 205124-050-92	20,76 - 21,52	L = 5 m
<hr/>		
205124-250-08	8,76 - 10,76	L = 25 m
205124-250-11	11,52 - 13,52	L = 25 m
205124-250-17	16,76 - 17,52	L = 25 m
NEW 205124-250-92	20,76 - 21,52	L = 25 m

Q-INFO MOD 6924

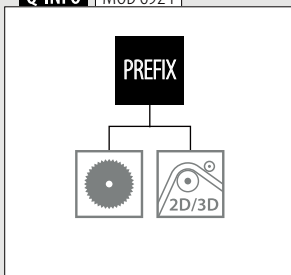

Q-INFO MOD 6924 / 5124 / 6734

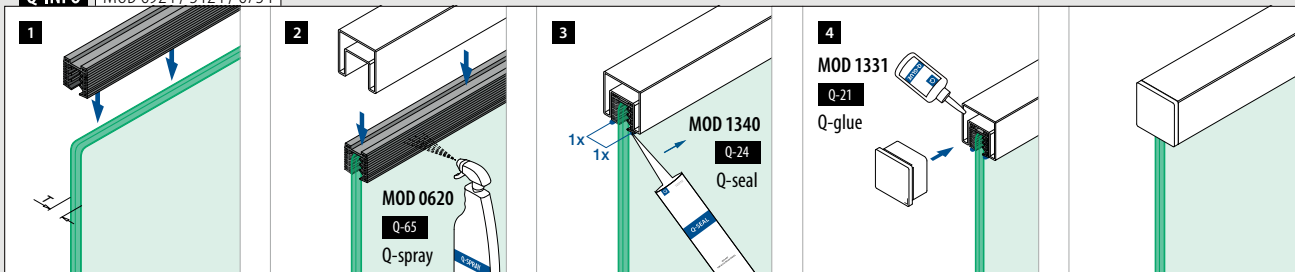

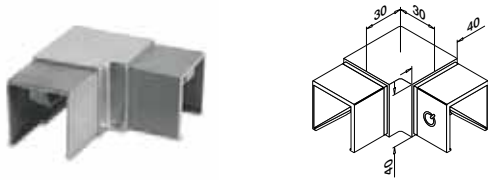

MOD 6343

V2A	304	Gebürstet		
	INDOOR*		<input type="checkbox"/>	
	136343-040-12	40 x 40		2
V4A	316	Gebürstet		
	OUTDOOR			
	146343-040-12	40 x 40		2



MOD 6794

V2A	304	Gebürstet		
	INDOOR*		<input type="checkbox"/>	
	136794-040-12	40 x 40		2
V4A	316	Gebürstet		
	OUTDOOR			
	146794-040-12	40 x 40		2

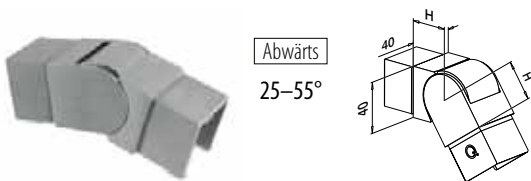

MOD 6342

V2A	304	Gebürstet			
	INDOOR*		<input type="checkbox"/>	H	
	136342-040-02-12	40 x 40		30	2
V4A	316	Gebürstet			
	OUTDOOR				
	146342-040-02-12	40 x 40		30	2



MOD 6342

V2A	304	Gebürstet			
	INDOOR*		<input type="checkbox"/>	H	
	136342-040-01-12	40 x 40		30	2
V4A	316	Gebürstet			
	OUTDOOR				
	146342-040-01-12	40 x 40		30	2

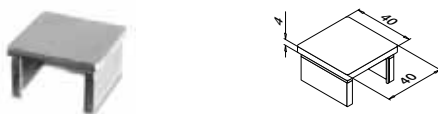

MOD 6734

V2A	304	Gebürstet		
	INDOOR*		<input type="checkbox"/>	
	136734-040-12	40 x 40		2
V4A	316	Gebürstet		
	OUTDOOR			
	146734-040-12	40 x 40		2

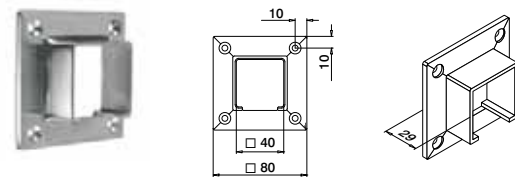

MOD 6545

V2A	304	Gebürstet			
	INDOOR*		<input type="checkbox"/>		
	136545-040-12	40 x 40		QS-7 471	2
V4A	316	Gebürstet			
	OUTDOOR				
	146545-040-12	40 x 40		QS-50 471	2



Glasleistenrohre

Glasleistenrohre

Quadratisch

166924-040-50-00 18 82

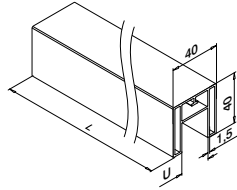
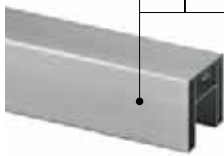

MOD 6924

Aluminium	Roh	U	□	⊞
166924-040-50-00		24	40 x 40	L = 5 m
Aluminium	Gebürstet			
OUTDOOR				
166924-040-50-18		24	40 x 40	L = 5 m
Aluminium	Black Line			
OUTDOOR				
NEW 166924-040-50-82		24	40 x 40	L = 5 m



Internationaler Geschmacksmusterschutz

Glasleistenrohre

Gummieinlagen

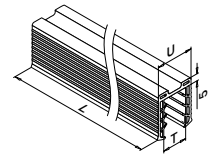

MOD 5124

Zubehör			
U = 24 mm			
Für monolithisches Glas	T	⊞	
205124-050-08	8 - 10		L = 5 m
205124-050-11	12		L = 5 m
205124-050-15	15		L = 5 m
205124-050-19	19		L = 5 m
Für laminiertes Glas			
205124-050-08	8,76 - 10,76		L = 5 m
205124-050-11	11,52 - 13,52		L = 5 m
205124-050-17	16,76 - 17,52		L = 5 m
NEW 205124-050-92	20,76 - 21,52		L = 5 m

Glasleistenrohre

Ecken

Quadratisch

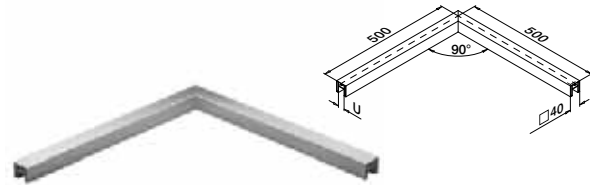

MOD 6324

Aluminium	Gebürstet	U	□	⊞
OUTDOOR				
166324-040-18		24	40 x 40 x 1,5	1
Aluminium	Black Line			
OUTDOOR				
NEW 166324-040-82		24	40 x 40 x 1,5	1

Glasleistenrohre

Endkappen

Quadratisch

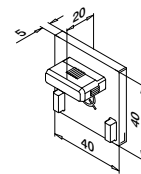

MOD 6734 - EASY HIT®

Aluminium	Roh	□	⊞
166734-040-00		40 x 40	2
Aluminium	Gebürstet		
OUTDOOR			
166734-040-18		40 x 40	2
Aluminium	Black Line		
OUTDOOR			
NEW 166734-040-82		40 x 40	2



Internationaler Geschmacksmusterschutz

Q-INFO Aluminium

00

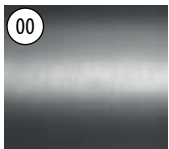

Roh

18

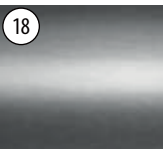

Gebürstet,
anodisiert

82



Schwarz, matt,
strukturiert

Q-INFO MOD 6924

PREFIX

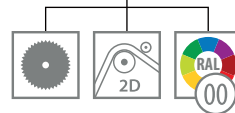

Q-INFO MOD 6924 / 5124 / 6734

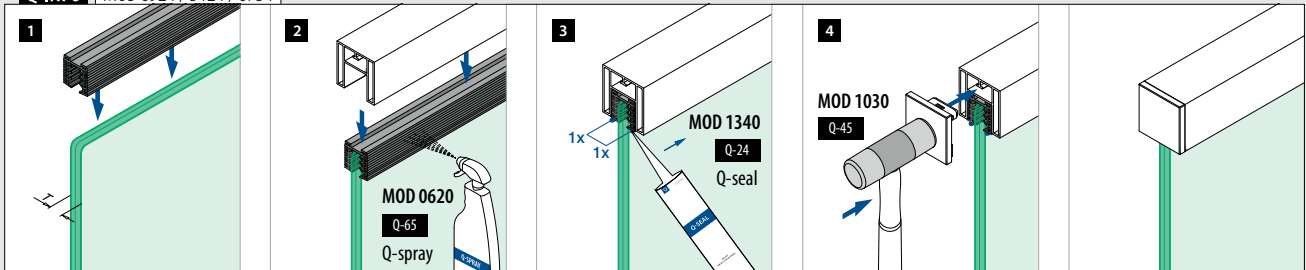

Verbinder

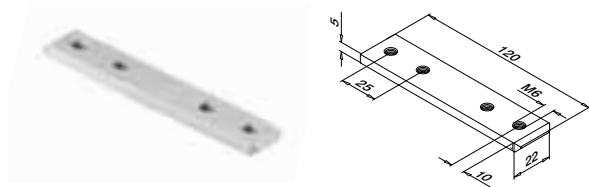

MOD 6795

Aluminium	Roh		
166795-339	QS-261	472	2

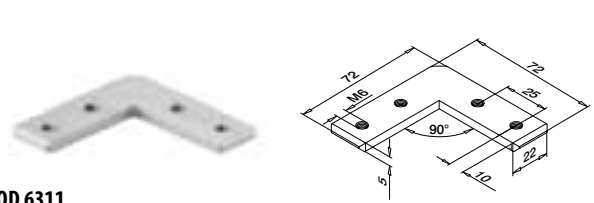

MOD 6311

Aluminium	Roh		
166311-339	QS-261	472	2

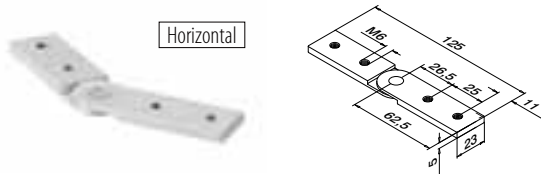

MOD 6797

Aluminium	Roh		
166797	QS-261	472	2

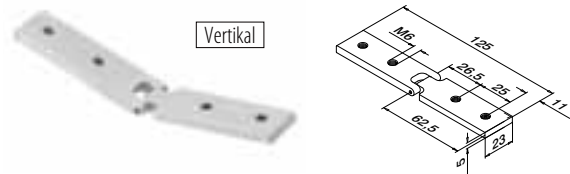

MOD 6798

Aluminium	Roh		
166798	QS-261	472	2

Q-INFO MOD 6311

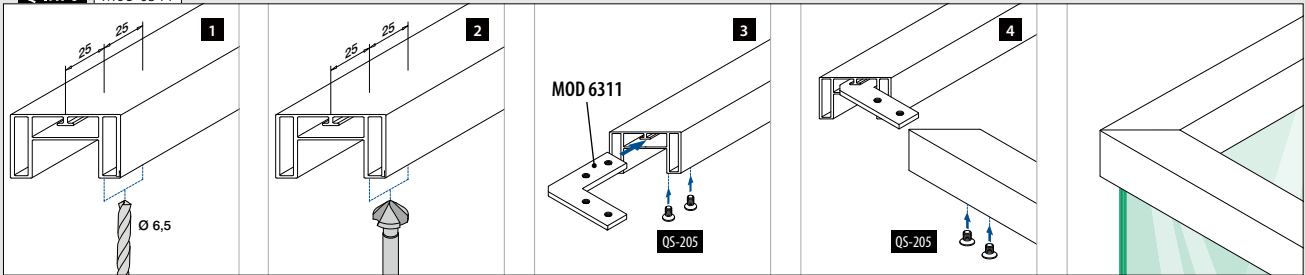

Q-INFO MOD 6797

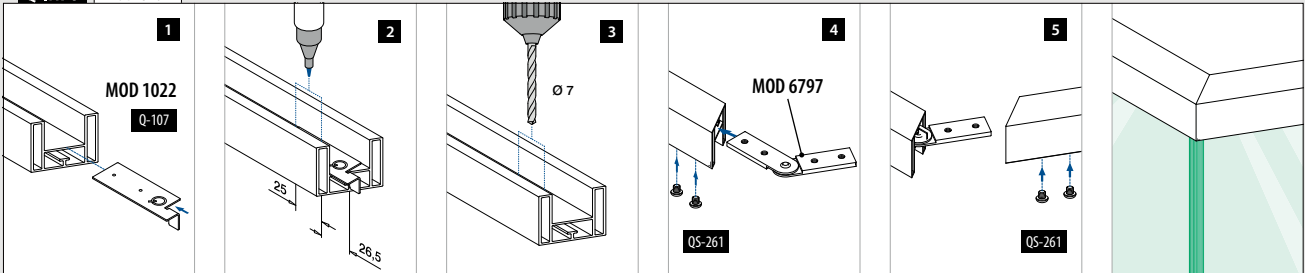

Q-INFO MOD 6798

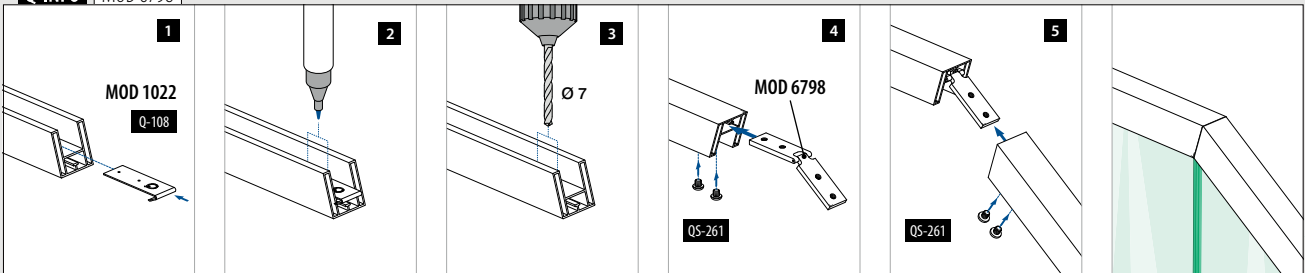

Q-INFO MOD 6798

Nach oben

Schneiden	45°	40°	35°	30°	25°	20°	15°	10°	5°	0°
Aussenwinkel	90°	100°	110°	120°	130°	140°	150°	160°	170°	180°
Abstand zum Rand (x)	30,5	30,0	29,5	29,0	28,5	28,0	27,5	27,0	27,0	26,5

Nach unten

Schneiden	0°	5°	10°	15°	20°	25°	30°	35°	40°	45°
Innenwinkel	180°	170°	160°	150°	140°	130°	120°	110°	100°	90°
Abstand zum Rand (x)	26,5	26,5	26,0	26,0	25,5	25,5	25,0	24,5	24,5	24,0

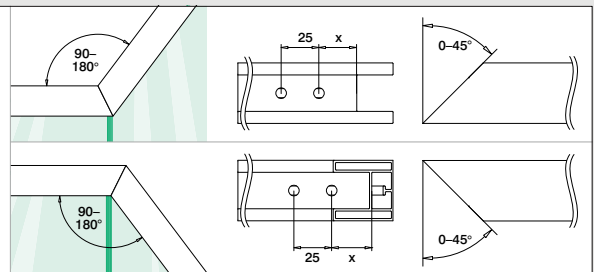



Glasleistenrohre

Glasleistenrohre

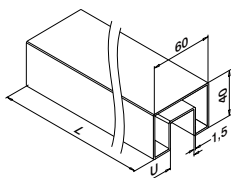
Rechteckig 



MOD 6924

V2A	304	Gebürstet		
INDOOR*		U		
SELL OUT	136924-640-50-12	24	60 x 40	L = 5 m
V4A	316	Gebürstet		
OUTDOOR				
	146924-640-50-12	24	60 x 40	L = 5 m



Glasleistenrohre

Gummieinlagen

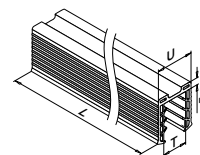

MOD 5124

Zubehör		
U = 24 mm		
Für monolithisches Glas		T 
205124-050-08	8 - 10	L = 5 m
205124-050-11	12	L = 5 m
205124-050-15	15	L = 5 m
205124-050-19	19	L = 5 m
<hr/>		
205124-250-08	8 - 10	L = 25 m
205124-250-11	12	L = 25 m
205124-250-15	15	L = 25 m
205124-250-19	19	L = 25 m
<hr/>		
Für laminiertes Glas		
205124-050-08	8,76 - 10,76	L = 5 m
205124-050-11	11,52 - 13,52	L = 5 m
205124-050-17	16,76 - 17,52	L = 5 m
NEW 205124-050-92	20,76 - 21,52	L = 5 m
<hr/>		
205124-250-08	8,76 - 10,76	L = 25 m
205124-250-11	11,52 - 13,52	L = 25 m
205124-250-17	16,76 - 17,52	L = 25 m
NEW 205124-250-92	20,76 - 21,52	L = 25 m

Q-INFO MOD 6924



Q-INFO MOD 6924 / 5124 / 6734

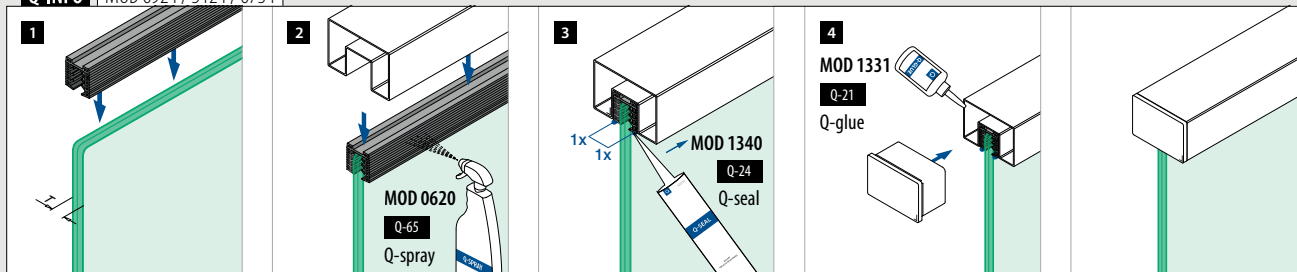

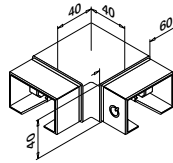

MOD 6343

V2A	304	Gebürstet		
	INDOOR*	Für <input type="checkbox"/>		
SELL OUT	136343-640-12	60 x 40	2	
V4A	316	Gebürstet		
	OUTDOOR			
	146343-640-12	60 x 40	2	

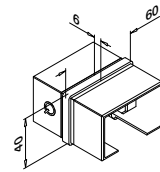

MOD 6794

V2A	304	Gebürstet		
	INDOOR*	Für <input type="checkbox"/>		
SELL OUT	136794-640-12	60 x 40	2	
V4A	316	Gebürstet		
	OUTDOOR			
	146794-640-12	60 x 40	2	



25–55°
Abwärts

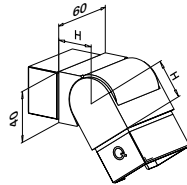

MOD 6342

V2A	304	Gebürstet		
	INDOOR*	Für <input type="checkbox"/>	H	
SELL OUT	136342-640-02-12	60 x 40	30	2
V4A	316	Gebürstet		
	OUTDOOR			
	146342-640-02-12	60 x 40	30	2



25–55°
Aufwärts

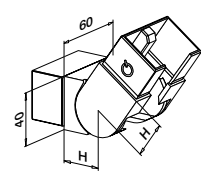

MOD 6342

V2A	304	Gebürstet		
	INDOOR*	Für <input type="checkbox"/>	H	
SELL OUT	136342-640-01-12	60 x 40	30	2
V4A	316	Gebürstet		
	OUTDOOR			
	146342-640-01-12	60 x 40	30	2

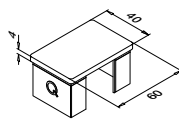

MOD 6734

V2A	304	Gebürstet		
	INDOOR*	Für <input type="checkbox"/>		
SELL OUT	136734-640-12	60 x 40	2	
V4A	316	Gebürstet		
	OUTDOOR			
	146734-640-12	60 x 40	2	

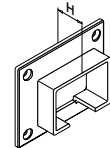
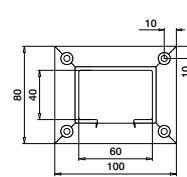

MOD 6545

V2A	304	Gebürstet		
	INDOOR*	Für <input type="checkbox"/>	H	
SELL OUT	136545-640-12	60 x 40	29	QS-7 471
V4A	316	Gebürstet		
	OUTDOOR			
	146545-640-12	60 x 40	29	QS-50 471



Glasleistenrohre

Glasleistenrohre

Rechteckig

166924-654-50-00 00 08

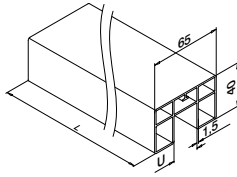
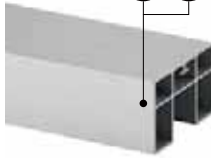

MOD 6924

Aluminium Roh

	U	<input type="checkbox"/>	<input type="checkbox"/>
166924-654-50-00	24	65 x 40	L = 5 m

Aluminium Matt Silbereffekt

OUTDOOR

166924-654-50-08	24	65 x 40	L = 5 m
------------------	----	---------	---------



Internationaler Geschmacksmusterschutz

Glasleistenrohre

Endkappen

Rechteckig

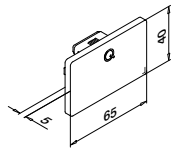

MOD 6734 - EASY HIT®

Aluminium Roh

	Für <input type="checkbox"/>	<input type="checkbox"/>
166734-654-00	65 x 40	2

Aluminium Matt Silbereffekt

OUTDOOR

166734-654-08	65 x 40	2
---------------	---------	---



Internationaler Geschmacksmusterschutz

Glasleistenrohre

Gummieinlagen

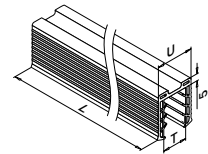

MOD 5124

Zubehör

U = 24 mm

Für monolithisches Glas	T	<input type="checkbox"/>
205124-050-08	8 - 10	L = 5 m
205124-050-11	12	L = 5 m
205124-050-15	15	L = 5 m
205124-050-19	19	L = 5 m

Für laminiertes Glas

205124-050-08	8,76 - 10,76	L = 5 m
205124-050-11	11,52 - 13,52	L = 5 m
205124-050-17	16,76 - 17,52	L = 5 m
205124-050-92	20,76 - 21,52	L = 5 m

NEW

Glasleistenrohre

Wandflansche

Rechteckig

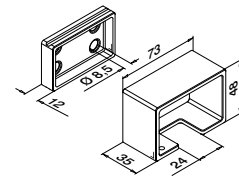

MOD 6545

Aluminium Roh

	Für <input type="checkbox"/>	<input type="checkbox"/>	<input type="checkbox"/>
166545-654-00	65 x 40	QS-55 <input type="checkbox"/> 470 / QS-20 <input type="checkbox"/> 472	2



Internationaler Geschmacksmusterschutz

SELL OUT Nur solange der Vorrat reicht.

Q-INFO MOD 6924



Q-INFO Aluminium

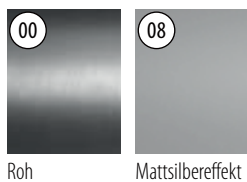

Q-INFO MOD 6924



Fügen Sie mithilfe des MOD 6926 Glasleistenrohres eine LED-Beleuchtung (Linear Light) hinzu

Q-INFO MOD 6924 / 5124 / 6734

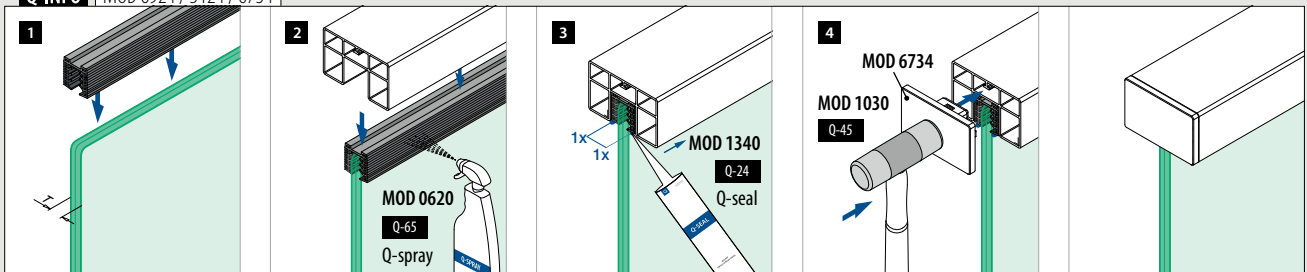

Verbinder

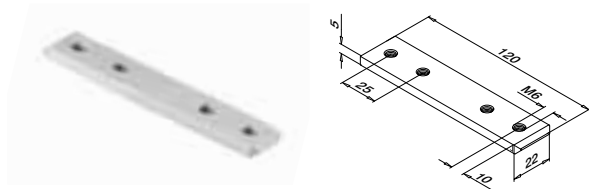

MOD 6795

Aluminium	Roh		
166795-339	QS-261	472	2

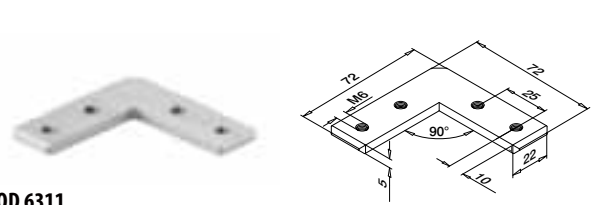

MOD 6311

Aluminium	Roh		
166311-339	QS-261	472	2

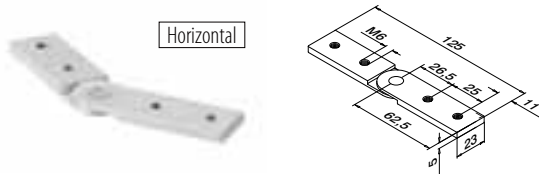

MOD 6797

Aluminium	Roh		
166797	QS-261	472	2

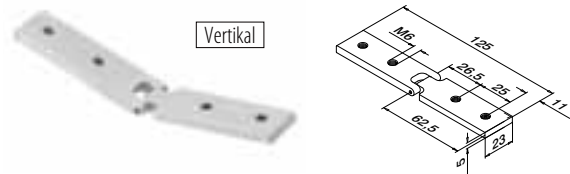

MOD 6798

Aluminium	Roh		
166798	QS-261	472	2

Q-INFO MOD 6311

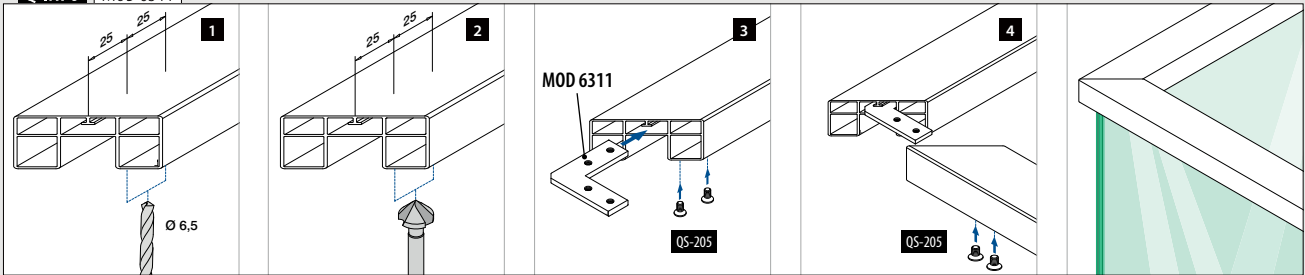

Q-INFO MOD 6797

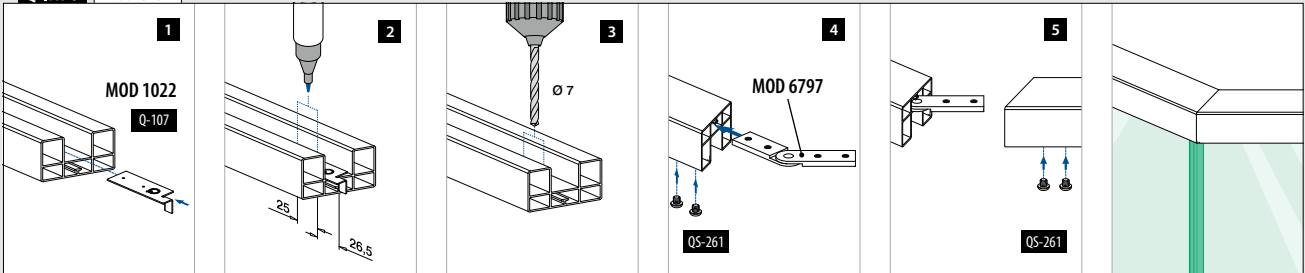

Q-INFO MOD 6798

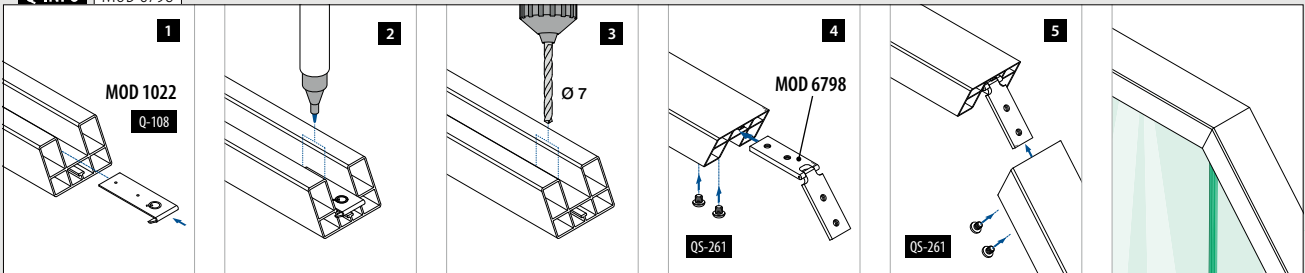

Q-INFO MOD 6798

Nach oben

Schneiden	45°	40°	35°	30°	25°	20°	15°	10°	5°	0°
Aussenwinkel	90°	100°	110°	120°	130°	140°	150°	160°	170°	180°
Abstand zum Rand (x)	30,5	30,0	29,5	29,0	28,5	28,0	27,5	27,0	27,0	26,5

Nach unten

Schneiden	0°	5°	10°	15°	20°	25°	30°	35°	40°	45°
Innenwinkel	180°	170°	160°	150°	140°	130°	120°	110°	100°	90°
Abstand zum Rand (x)	26,5	26,5	26,0	26,0	25,5	25,5	25,0	24,5	24,5	24,0

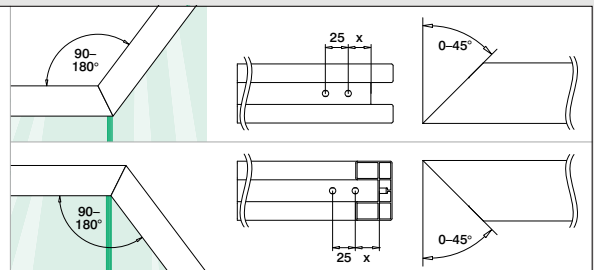

Glasleistenrohre

Glasleistenrohre

HYBRID 33x39

166911-339-50-00 08 18 82

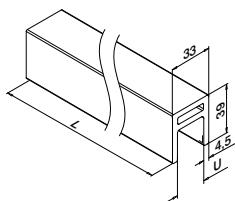
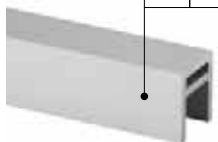

MOD 6911

Aluminium	Roh		
		U	
166911-339-50-00	24		L = 5 m
Aluminium	Matt Silbereffekt		
		OUTDOOR	
SELL OUT	166911-339-50-08	24	L = 5 m
	Aluminium	Gebürstet	
		OUTDOOR	
NEW	166911-339-50-18	24	L = 5 m
	Aluminium	Black Line	
		OUTDOOR	
NEW	166911-339-50-82	24	L = 5 m



Internationaler Geschmacksmusterschutz

Glasleistenrohre

Gummieinlagen

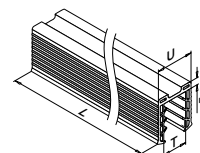

MOD 5124

Zubehör			
		U = 24 mm	
		Für monolithisches Glas	T
205124-050-08	8 - 10		L = 5 m
		Für laminiertes Glas	
205124-050-08	8,76 - 10,76		L = 5 m
205124-050-11	11,52 - 13,52		L = 5 m

Glasleistenrohre

Wandflansche

HYBRID 33x39

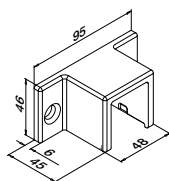

MOD 6515

V4A	316	Gebürstet	
		OUTDOOR	
	146515-339-12	QS-214 468	2
V4A	316	Black Line	
		OUTDOOR	
	146515-339-82	QS-214 468	2



Q-INFO Aluminium

00	08	18	82 RAL 9005
Roh	Mattsilbereffekt	Gebürstet, anodisiert	Pulverbeschichtet Schwarz, matt, strukturiert

Q-INFO 316

12	82 RAL 9005
Gebürstet	Pulverbeschichtet Schwarz, matt, strukturiert

Q-INFO MOD 6911

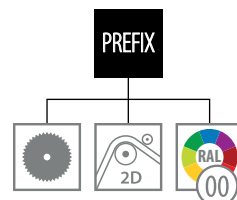

Q-INFO

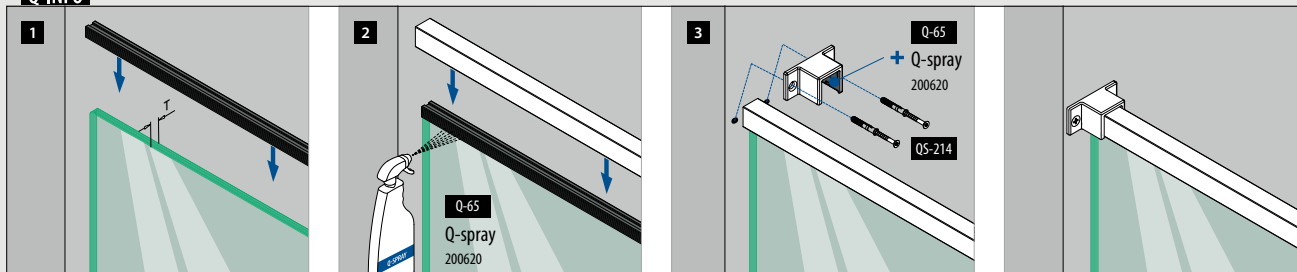



Links / rechts

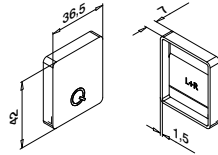

MOD 6913

Aluminium	Roh	
166913-339-00		2
Aluminium	Matt Silbereffekt	
OUTDOOR		
SELL OUT		
166913-339-08		2
Aluminium	Gebürstet	
OUTDOOR		
NEW		
166913-339-18		2
Aluminium	Black Line	
OUTDOOR		
NEW		
166913-339-82		2

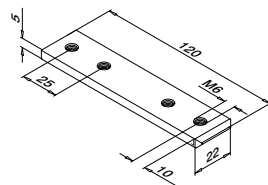

MOD 6795

Aluminium	Roh	
166795-339	QS-261	472
		2

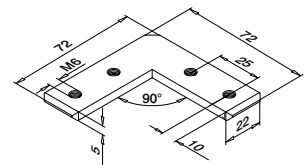

MOD 6311

Aluminium	Roh	
166311-339	QS-261	472
		2

SELL OUT Nur solange der Vorrat reicht.

Q-INFO MOD 6311

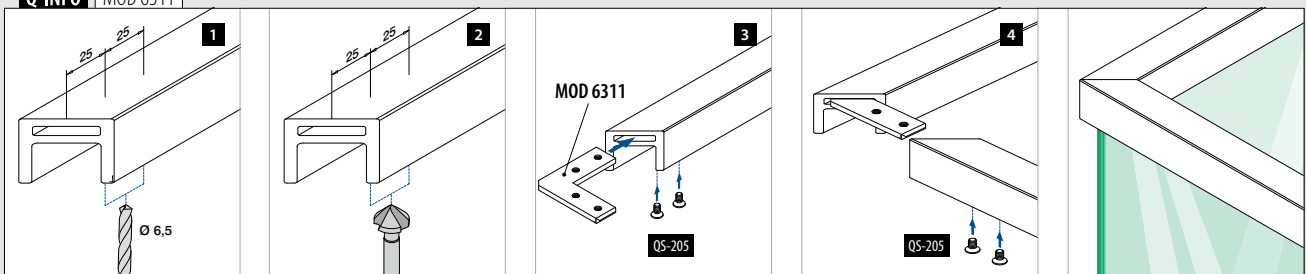



2

SYSTEME FÜR FRANZÖSISCHE BALKONE

Easy Glass® View	190 - 197
Easy Glass® MOD 6507-6508	198 - 209
Mit Glasklemmen	210 - 211
Mit Glasadaptern	212 - 217
Fensterabsturzstangen	218 - 231



EASY GLASS® MOD 6507 / 6508

198



Finden Sie alle Informationen zu Französischen Balkonen online:



<https://q-ne.ws/JulietBalcony23>

MIT GLAS-ADAPTERN

212

MIT GLAS-KLEMMEN

210

FENSTER-ABSTURZ-STANGEN

218

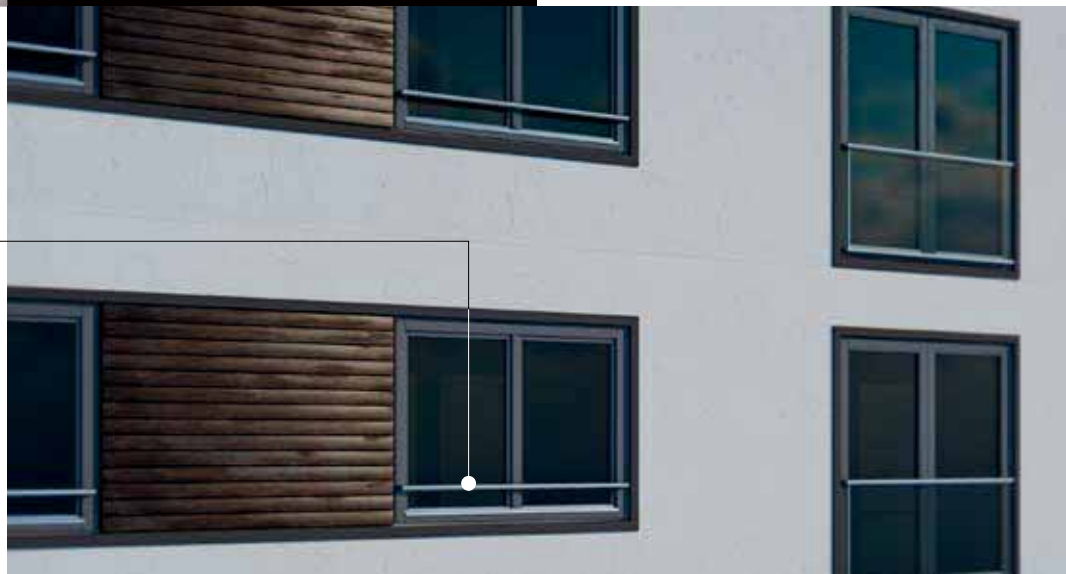

VIELSEITIG UND FAST UNSICHTBAR

Raumhohe Fenster sind sowohl in Wohn- als auch Bürogebäuden äusserst beliebt, da die Bewohner und Benutzer vom maximierten Tageslichteinfall profitieren. Für eine ausreichende Absturzsicherung ist jedoch ein französischer Balkon an den Fenstern notwendig.

In unserem Sortiment finden Sie zwei Systeme, die speziell für diesen Einsatz entwickelt wurden: Easy Glass® View, das sowohl an der Fassade, in der Laibung oder auf dem Fensterrahmen montiert werden kann, und Easy Glass® MOD 6507-6508 mit seinen runden oder eckigen Wandflanschen und Glasleistenrohren.

Daneben gibt es aber noch weitere Lösungen, um gläserne französische Balkone zu kreieren – zum Beispiel mit den Q-railing Glasklemmen und Glasadaptern. Für eine Absicherung an hohen Fenstern können Sie auch die neuen schlichten Absturzstangen verwenden. Wählen Sie dafür aus unterschiedlichen runden oder eckigen Elementen aus.



EASY GLASS®
VIEW

190



Q-railing



Beanspruchung: Leicht und mittel
Verwendung: Innen- und Aussenbereich
Montage: Wandmontage
(Fassade, Fenster oder Laibung)
Anwendung: Französische Balkone
Material: Aluminium (gebürstet anodisiert,
roh und pulverbeschichtet)
Glasstärke: 12 bis 21,52 mm

Finden Sie alle Informationen
zu Easy Glass View online:

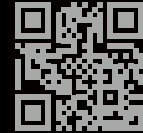

[https://q-ne.ws/
View23](https://q-ne.ws/View23)

EASY GLASS[®] VIEW



Minimalistische französische Balkone für maximalen Halt

Den fast unsichtbaren französischen Balkon Easy Glass® View können Sie entweder an der Fassade, in der Fensterlaibung oder direkt auf dem Fensterrahmen montieren. Die schlanken Aluminium-Profile können zudem nach Wunsch pulverbeschichtet werden – passend zur Fenster- oder Fassadenfarbe.

Easy Glass® View	CH
Max. Holmlast (kN/m)	0.8
Max. Breite (Meter)	2.8



Bitte beachten Sie die Spezifikationen wie Befestigungs- und Glasmasse sowie Glastypen der jeweiligen Zertifikate.

International getestet/berechnet/zertifiziert:



- 1 Schaffen Sie einen praktisch unsichtbaren französischen Balkon dank der extrem schlanken Profile und unsichtbaren Montagepunkte von Easy Glass View.
- 2 Wählen Sie aus drei Montagemöglichkeiten aus: Fassadenmontage, Montage in der Fensterlaibung oder Fensterrahmenmontage.



EASY GLASS® VIEW VARIANTEN

- Montage mit Ankern oder Schrauben (abhängig vom Untergrund)
- Die Montage in der Laibung kann von innen vorgenommen werden
- Profile und Endkappen können pulverbeschichtet werden

Fassadenmontage

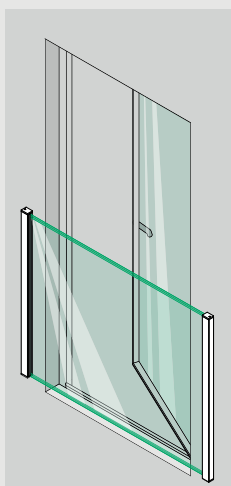

Fensterrahmenmontage

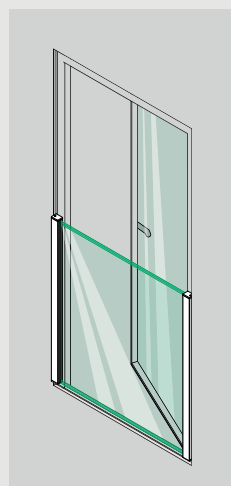

Montage in der Fensterlaibung

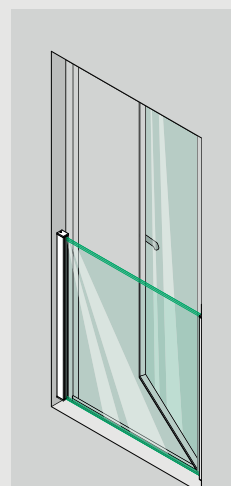

Montage mit Mittelprofil

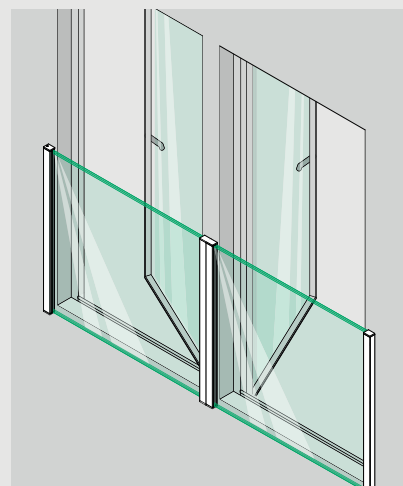

Wandprofil

Easy Glass® View

Fassadenmontage

Montage in der Fensterlaibung

Rahmenmontage

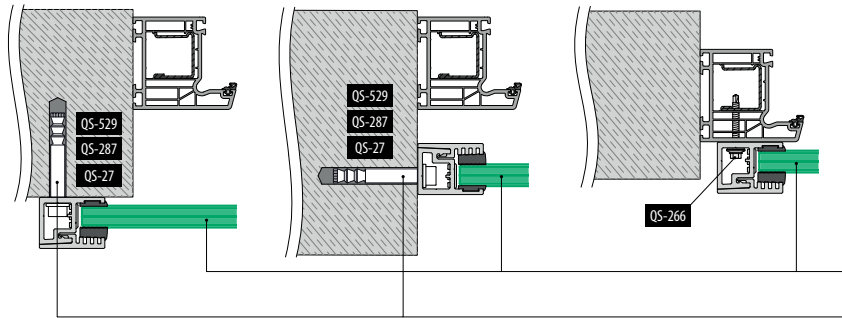

Bitte beachten Sie die Spezifikationen wie Befestigungs- und Glasmasse sowie Glasstypen der jeweiligen Zertifikate und statischen Berechnungen.

VSG gemäss Statik

Anker: 457 - 463

Montage mit Mittelprofil

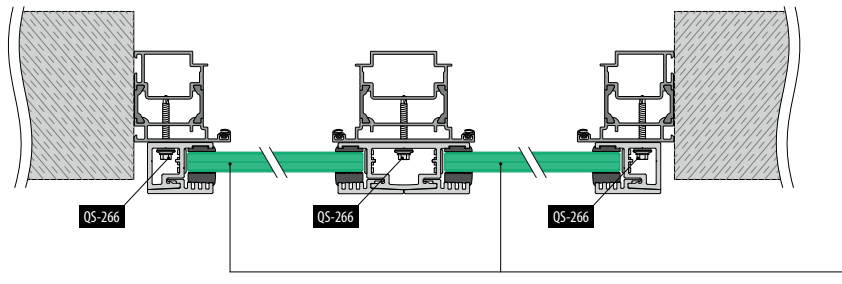

VSG gemäss Statik

Wandprofil

Profilsets zur Wandmontage

Vorgebohrt

Inklusive: 2 Profile für 1100 mm hohes Glas, 4 Endkappen und 4 Abdeckstopfen

Montage in der Fensterlaibung

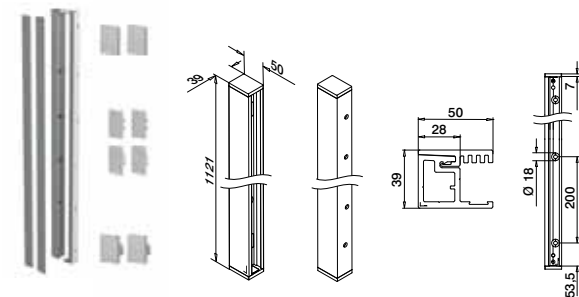

MOD 6839

Aluminium Roh

166839-011-02-00 457 - 463 L = 2x 1,1 m

Aluminium Gebürstet

OUTDOOR

166839-011-02-18 457 - 463 L = 2x 1,1 m



Inklusive: 2 Profile für 1100 mm hohes Glas, 4 Endkappen und 4 Abdeckstopfen

Fassaden- / Rahmenmontage

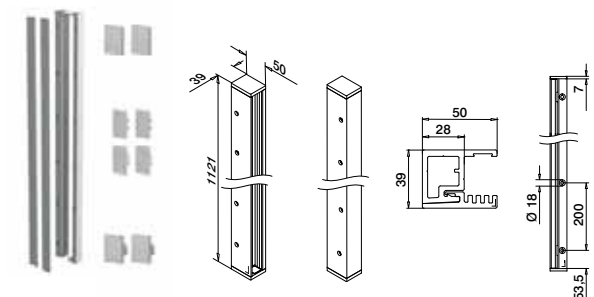

MOD 6839

Aluminium Roh

166839-011-01-00 457 - 463 L = 2x 1,1 m

Aluminium Gebürstet

OUTDOOR

166839-011-01-18 457 - 463 L = 2x 1,1 m



Q-INFO

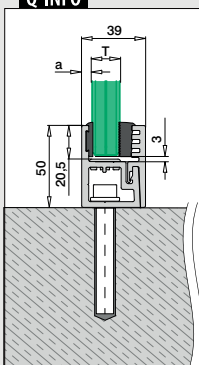

Für monolithisches Glas	T	a
20683x-xxx-12	12	10,5
20683x-xxx-15	15	10,5
20683x-xxx-19	19	6,5
Für laminiertes Glas	T	a
20683x-xxx-13	12,76	10,5
20683x-xxx-14	13,52	10,5
20683x-xxx-17	16,76	6,5
20683x-xxx-18	17,52	6,5
20683x-xxx-21	20,76	6,5
20683x-xxx-22	21,52	6,5

Q-INFO

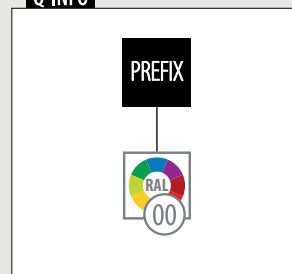

Profilssets zur Wandmontage

Inklusive: 2 Profile für 1100 mm hohes Glas, 4 Endkappen und 4 Abdeckstopfen

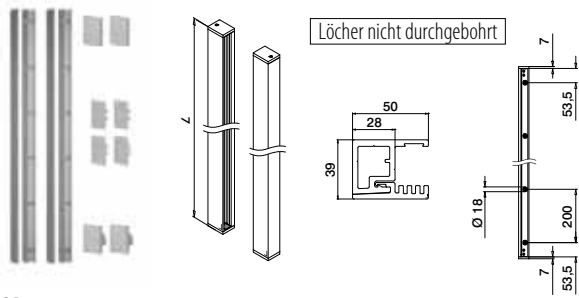

MOD 6839

Aluminium	Roh		
166839-011-00-00	457 - 463		L = 2x 1,1 m
Aluminium	Gebürstet		
OUTDOOR			
166839-011-00-18	457 - 463		L = 2x 1,1 m
Aluminium	Anthrazitgrau RAL 7016		
OUTDOOR			
NEW	166839-011-00-33	457 - 463	L = 2x 1,1 m
Aluminium	Black Line		
OUTDOOR			
NEW	166839-011-00-82	457 - 463	L = 2x 1,1 m



Internationaler Geschmacksmusterschutz

Inklusive: 1 Profil für 1100 mm hohes Glas, 2 Endkappen und 4 Abdeckstopfen

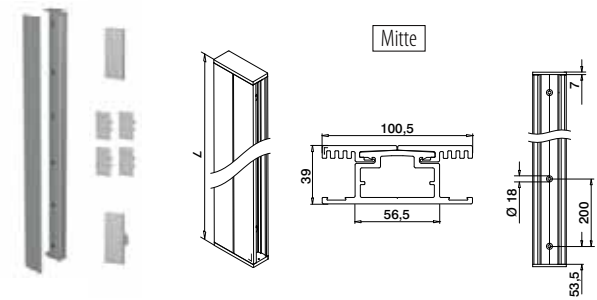

MOD 6849

Aluminium	Roh		
166849-011-00-00	457 - 463		L = 1,1 m
Aluminium	Gebürstet		
OUTDOOR			
166849-011-00-18	457 - 463		L = 1,1 m
Aluminium	Anthrazitgrau RAL 7016		
OUTDOOR			
166849-011-00-33	457 - 463		L = 1,1 m
Aluminium	Black Line		
OUTDOOR			
166849-011-00-82	457 - 463		L = 1,1 m



Q-INFO Aluminium

00	18	33 RAL 7016	82 RAL 9005
Roh	Gebürstet, anodisiert	Anthrazitgrau, matt, glatt	Schwarz, matt, strukturiert Pulverbeschichtet

Q-INFO

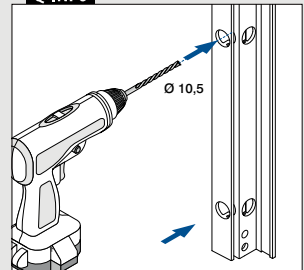

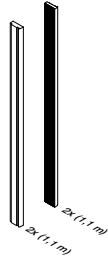

Kombinierbar mit
MOD 6839 und MOD 6849

**MOD 6831****Zubehör**

Für monolithisches Glas	T	
206831-211-12	12	L = 2x 1,1 m
206831-211-15	15	L = 2x 1,1 m
206831-211-19	19	L = 2x 1,1 m

Für laminiertes Glas

206831-211-13	12,76	L = 2x 1,1 m
206831-211-14	13,52	L = 2x 1,1 m
206831-211-17	16,76	L = 2x 1,1 m
206831-211-18	17,52	L = 2x 1,1 m
206831-211-21	20,76	L = 2x 1,1 m
206831-211-22	21,52	L = 2x 1,1 m

NEW

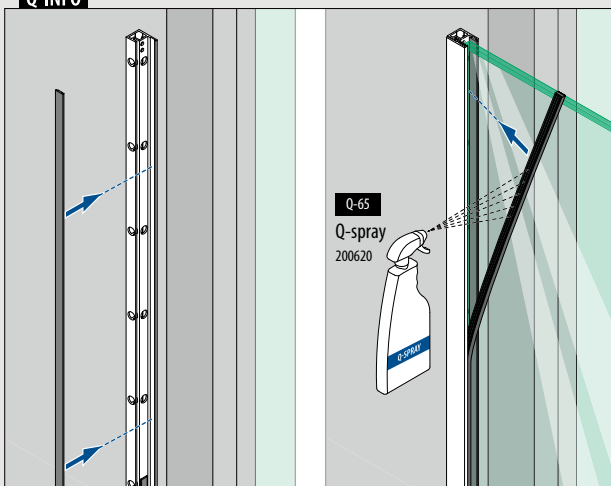
Q-INFO

Profile zur Wandmontage

Löcher nicht durchgebohrt

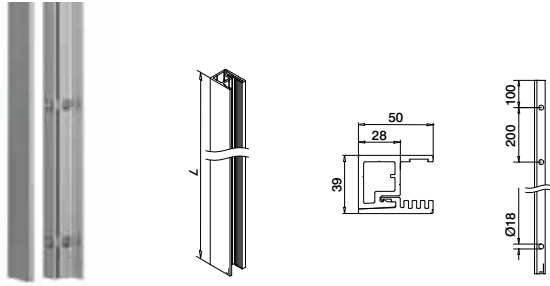

MOD 6830

Aluminium Roh		
166830-050-00-00	457 - 463	L = 5 m
Aluminium Gebürstet		
OUTDOOR		
166830-050-00-18	457 - 463	L = 5 m



Internationaler Geschmacksterschutz

Profile zur Wandmontage

Vorgebohrt

Montage in der Fensterlaibung

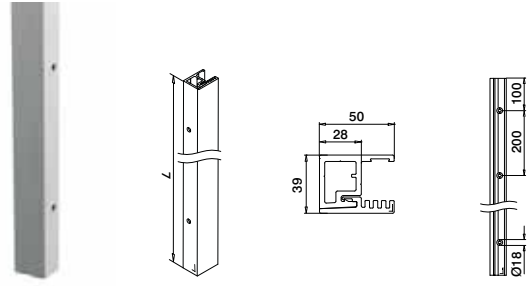

MOD 6830

Aluminium Roh		
166830-050-02-00	457 - 463	L = 5 m
Aluminium Gebürstet		
OUTDOOR		
166830-050-02-18	457 - 463	L = 5 m



Fassaden- / Rahmenmontage

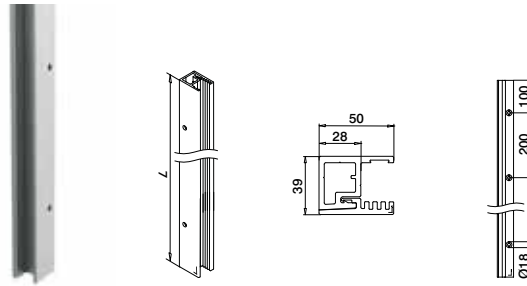

MOD 6830

Aluminium Roh		
166830-050-01-00	457 - 463	L = 5 m
Aluminium Gebürstet		
OUTDOOR		
166830-050-01-18	457 - 463	L = 5 m



Mitte

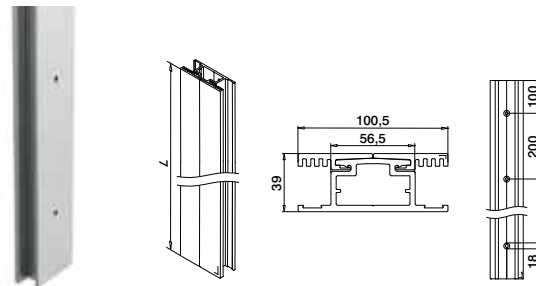

MOD 6840

Aluminium Roh		
166840-050-00-00	457 - 463	L = 5 m
Aluminium Gebürstet		
OUTDOOR		
166840-050-00-18	457 - 463	L = 5 m



Q-INFO

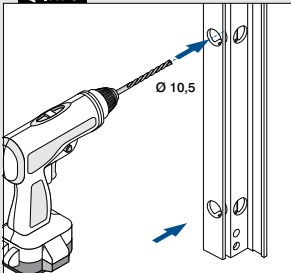

Q-INFO

Aluminium

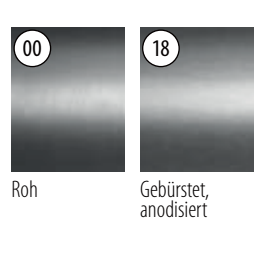

Q-INFO

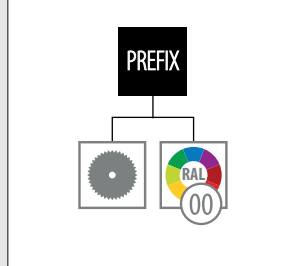

Q-INFO

MOD 6830-050-00

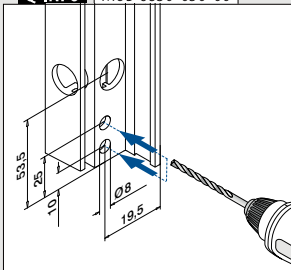

Q-INFO

MOD 6830-050-01

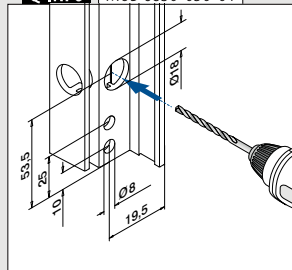

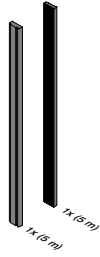

Kombinierbar mit
MOD 6839 und MOD 6849

**MOD 6831****Zubehör**

Für monolithisches Glas	T	
206831-050-12	12	L = 5 m
206831-050-15	15	L = 5 m
206831-050-19	19	L = 5 m

Für laminiertes Glas

206831-050-13	12,76	L = 5 m
206831-050-14	13,52	L = 5 m
206831-050-17	16,76	L = 5 m
206831-050-18	17,52	L = 5 m
206831-050-21	20,76	L = 5 m
206831-050-22	21,52	L = 5 m

NEW

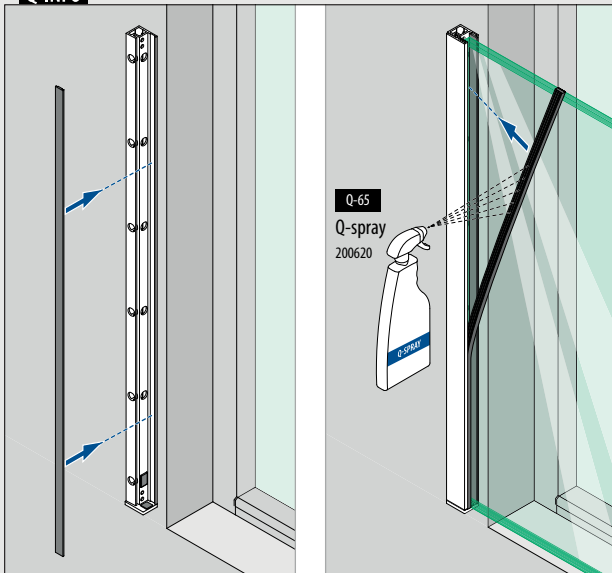
Q-INFO

Endkappen für MOD 6830 / 6839

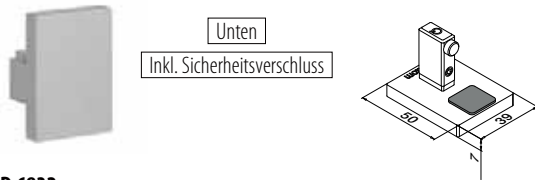

MOD 6832

Aluminium Roh	
166832-01-00	2
Aluminium Gebürstet	
OUTDOOR	
166832-01-18	2



Internationaler Geschmacksmusterschutz



MOD 6832 - EASY HIT®

Aluminium Roh	
166832-02-00	2
Aluminium Gebürstet	
OUTDOOR	
166832-02-18	2



Internationaler Geschmacksmusterschutz

Endkappen für MOD 6840 / 6849

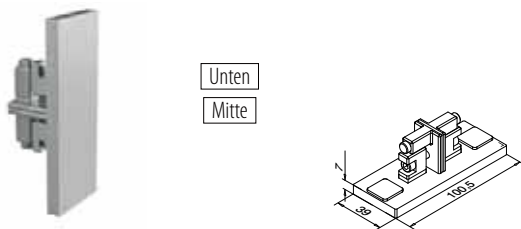

MOD 6842

Aluminium Roh	
166842-01-00	2
Aluminium Gebürstet	
OUTDOOR	
166842-01-18	2



Internationaler Geschmacksmusterschutz

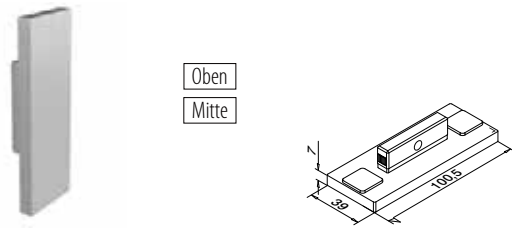

MOD 6842 - EASY HIT®

Aluminium Roh	
166842-02-00	2
Aluminium Gebürstet	
OUTDOOR	
166842-02-18	2



Internationaler Geschmacksmusterschutz

Abdeckstopfen

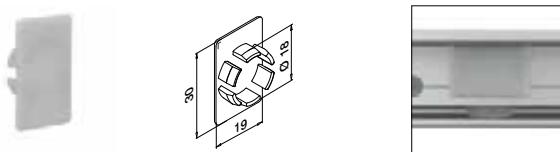

MOD 6838

Kunststoff Aluminium RAL 9006	
OUTDOOR	
156838-36	4

Q-INFO Aluminium

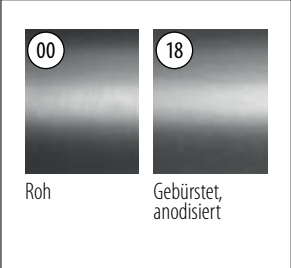

Q-INFO MOD 6832-01

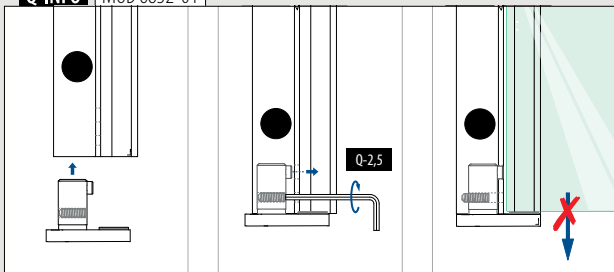

Q-INFO MOD 6842-01

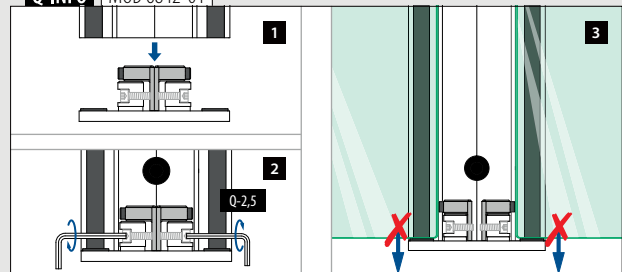



Beanspruchung: Leicht und mittel
Verwendung: Innen- und Aussenbereich
Montage: Wandmontage (Fassade)
Anwendung: Französische Balkone
Material: Aluminium (gebürstet anodisiert und roh) und gebürsteter Edelstahl V4A
Glasstärke: 8 bis 21,52 mm

Finden Sie alle Informationen zu Easy Glass MOD 6507-6508 online:



<https://q-ne.ws/6507-6508-23>

EASY GLASS® MOD 6507-6508



Elegante französische Balkone mit zahlreichen Möglichkeiten

Die französischen Balkone Easy Glass® MOD 6507-6508 schaffen einen minimalistischen, dennoch sicheren Fallschutz an bodentiefen Fenstern. Die Glasfüllung wird mithilfe der Wandflansche und Glasleistenrohre problemlos an der Fassade montiert. Dabei können Sie aus runden oder rechteckigen Geländer-Komponenten auswählen.

International getestet/berechnet/zertifiziert:



- 1 Bringen Sie die Glasleistenrohre entweder waagrecht oder senkrecht an der Fassade an.
- 2 Easy Glass MOD 6507-6508 ist eine stilvolle Erweiterung für nahezu jede Fassade.



EASY GLASS® MOD 6507-6508 VARIANTEN

- Wandmontage mit Verbundankern
- Horizontale sowie vertikale Befestigung möglich

Fassadenmontage
rund

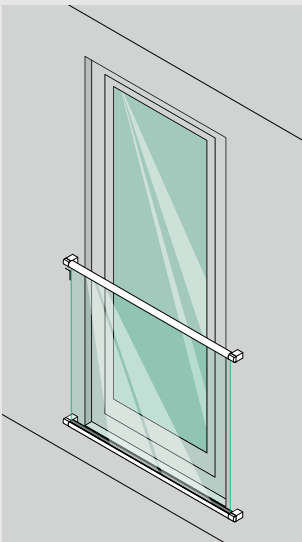

Fassadenmontage
quadratisch

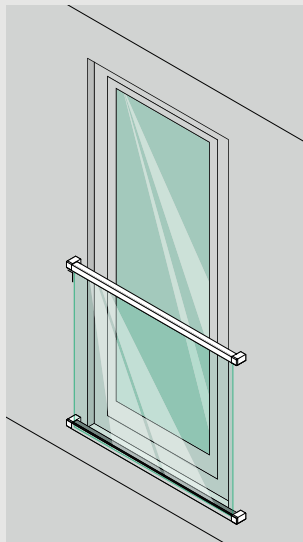

Glasleistenrohre

Easy Glass® MOD 6507

Fassadenmontage

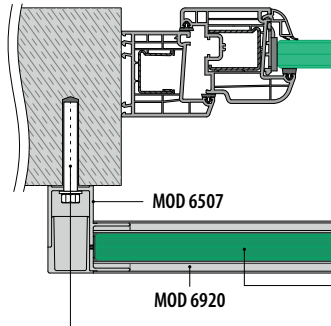

Rahmenmontage

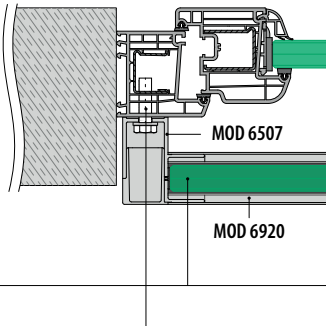

Bitte beachten Sie die Spezifikationen wie Befestigungs- und Glasmasse sowie Glastypen der jeweiligen Zertifikate und statischen Berechnungen.

VSG gemäss Statik

Anker: ■457 - 463

Glasleistenrohre

Wandflansche

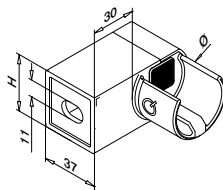

MOD 6507

V4A	316	Gebürstet				
SELL OUT	OUTDOOR	Für Ø	H			
146507-042-01		42,4	37	■457 - 463	2	



Internationaler Geschmacksmusterschutz

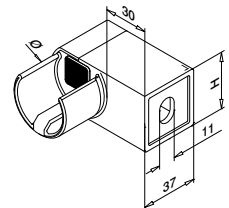

MOD 6507

V4A	316	Gebürstet				
SELL OUT	OUTDOOR	Für Ø	H			
146507-042-02		42,4	37	■457 - 463	2	



Internationaler Geschmacksmusterschutz

Glasleistenrohre

Glasleistenrohre

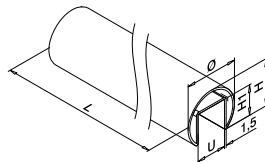

MOD 6920

V4A	316	Gebürstet				
SELL OUT	OUTDOOR	U	Ø	H	H1	
146920-042-50-12		24	42,4	37	24	L = 5 m



Glasleistenrohre

Gummieinlagen

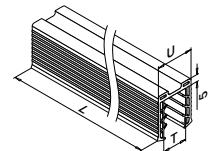

MOD 5124

Zubehör

U = 24 mm		
Für monolithisches Glas	T	
205124-050-08	8 - 10	L = 5 m
205124-050-11	12	L = 5 m
205124-050-15	15	L = 5 m
205124-050-19	19	L = 5 m

Für laminiertes Glas

205124-050-08	8,76 - 10,76	L = 5 m
205124-050-11	11,52 - 13,52	L = 5 m
205124-050-17	16,76 - 17,52	L = 5 m
NEW 205124-050-92	20,76 - 21,52	L = 5 m

Q-INFO

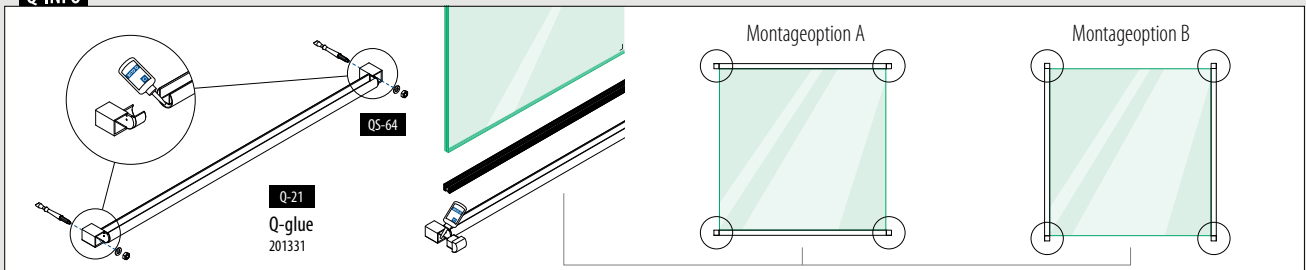

Wandflansche

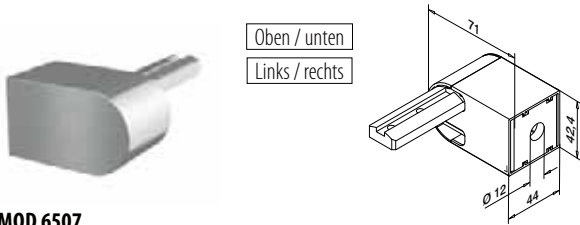

MOD 6507

Aluminium	Roh			
166507-042-00-00	42,4		457 - 463	2
Aluminium	Gebürstet			
OUTDOOR				
166507-042-00-18	42,4		457 - 463	2

NEW

Glasleistenrohre

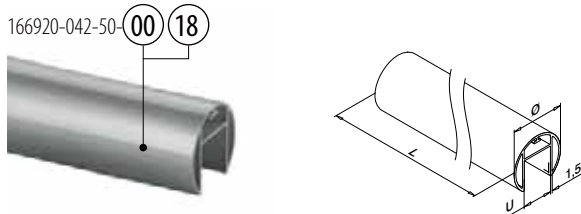

MOD 6920

Aluminium	Roh	U	Ø	
166920-042-50-00		24	42,4	L = 5 m
Aluminium	Gebürstet			
OUTDOOR				
166920-042-50-18		24	42,4	L = 5 m



Internationaler Geschmacksmusterschutz

Gummieinlagen



MOD 5124

Zubehör

U = 24 mm

Für monolithisches Glas	T	
205124-050-08	8 - 10	L = 5 m
205124-050-11	12	L = 5 m
205124-050-15	15	L = 5 m
205124-050-19	19	L = 5 m

Für laminiertes Glas

205124-050-08	8,76 - 10,76	L = 5 m
205124-050-11	11,52 - 13,52	L = 5 m
205124-050-17	16,76 - 17,52	L = 5 m
NEW 205124-050-92	20,76 - 21,52	L = 5 m

Q-INFO MOD 6920

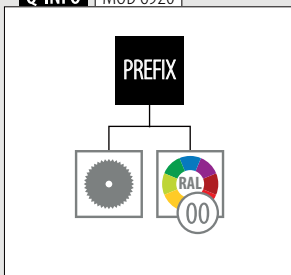

Q-INFO Aluminium



Q-INFO

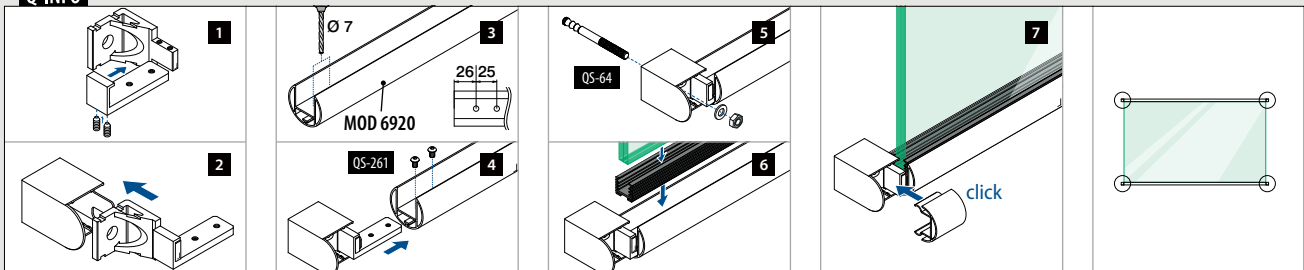

Glasleistenrohre

Easy Glass® MOD 6508

Fassadenmontage

Rahmenmontage

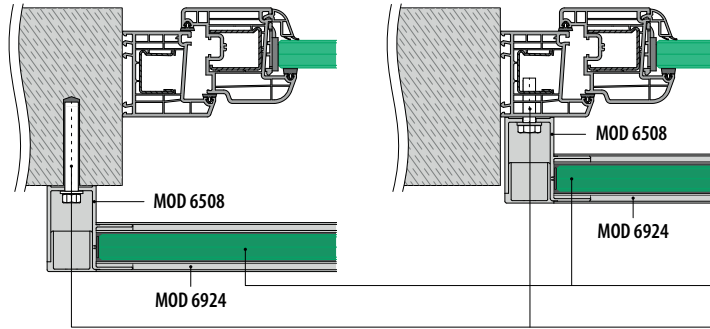

Bitte beachten Sie die Spezifikationen wie Befestigungs- und Glasmasse sowie Glastypen der jeweiligen Zertifikate und statischen Berechnungen.

VSG gemäss Statik

Anker: ■457 - 463

Glasleistenrohre

Wandflansche

Quadratisch □

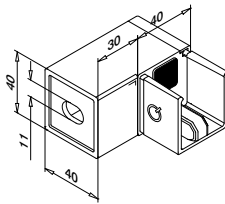

MOD 6508

V4A	316	Gebürstet		
OUTDOOR		□		
146508-040-01	40 x 40	■ 457 - 463	2	



Internationaler Geschmacksmusterschutz

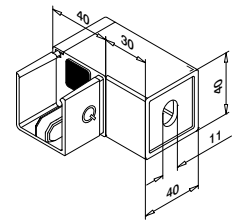

MOD 6508

V4A	316	Gebürstet		
OUTDOOR		□		
146508-040-02	40 x 40	■ 457 - 463	2	



Internationaler Geschmacksmusterschutz

Glasleistenrohre

Glasleistenrohre

Quadratisch □

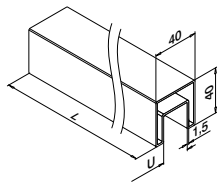

MOD 6924

V4A	316	Gebürstet		
OUTDOOR		U	□	
146924-040-50-12	24	40 x 40	L = 5 m	



Glasleistenrohre

Gummieinlagen

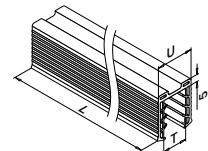

MOD 5124

Zubehör

U = 24 mm		
Für monolithisches Glas		
	T	
205124-050-08	8 - 10	L = 5 m
205124-050-11	12	L = 5 m
205124-050-15	15	L = 5 m
205124-050-19	19	L = 5 m

Für laminiertes Glas

205124-050-08	8,76 - 10,76	L = 5 m
205124-050-11	11,52 - 13,52	L = 5 m
205124-050-17	16,76 - 17,52	L = 5 m
NEW 205124-050-92	20,76 - 21,52	L = 5 m

Q-INFO

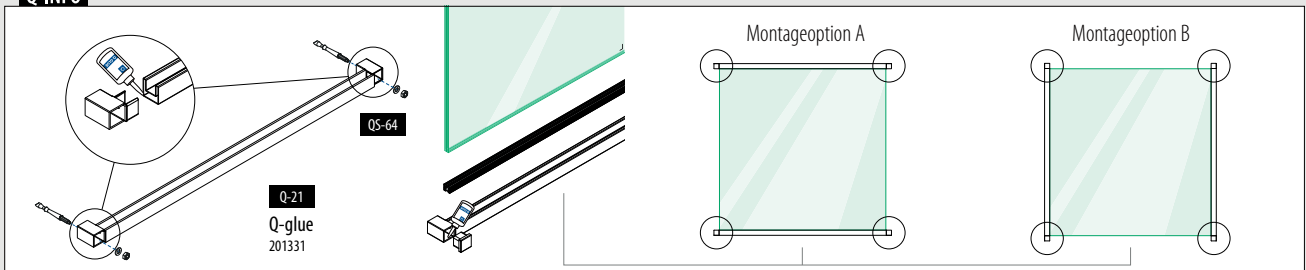

Wandflansche

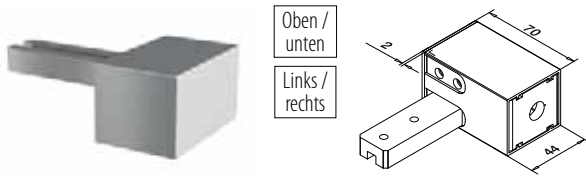

MOD 6508

Aluminium	Gebürstet		
OUTDOOR			
166508-040-18	40 x 40	457 - 463	2

NEW

Glasleistenrohre

Quadratisch

166924-040-50-00 18

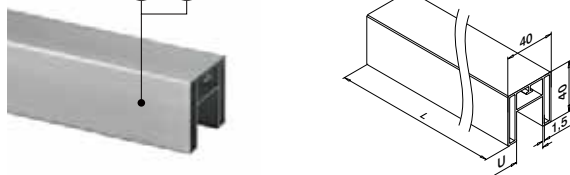

MOD 6924

Aluminium	Roh		
	U	<input type="checkbox"/>	
166924-040-50-00	24	40 x 40	L = 5 m
Aluminium	Gebürstet		
OUTDOOR			
166924-040-50-18	24	40 x 40	L = 5 m



Internationaler Geschmacksmusterschutz

Gummieinlagen



MOD 5124

Zubehör		
U = 24 mm		
Für monolithisches Glas	T	
205124-050-08	8 - 10	L = 5 m
205124-050-11	12	L = 5 m
205124-050-15	15	L = 5 m
205124-050-19	19	L = 5 m

Für laminiertes Glas		
205124-050-08	8,76 - 10,76	L = 5 m
205124-050-11	11,52 - 13,52	L = 5 m
205124-050-17	16,76 - 17,52	L = 5 m
NEW 205124-050-92	20,76 - 21,52	L = 5 m

Q-INFO MOD 6924

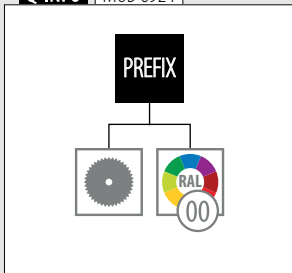

Q-INFO Aluminium

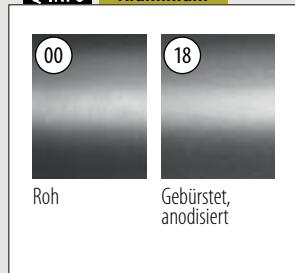

Q-INFO

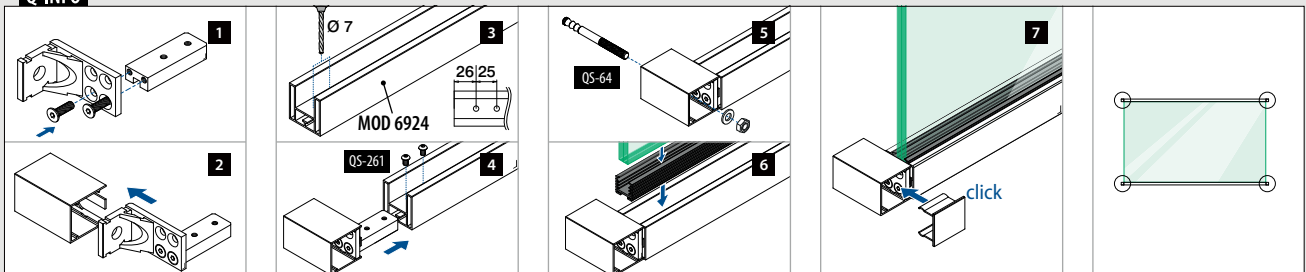

Glasleistenrohre

Easy Glass® MOD 6508

Fassadenmontage

Rahmenmontage

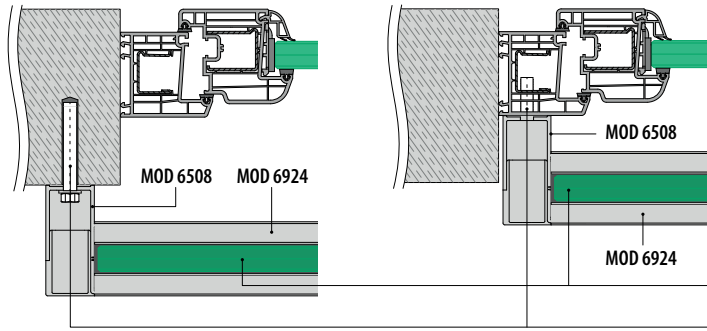

Bitte beachten Sie die Spezifikationen wie Befestigungs- und Glasmasse sowie Glasstypen der jeweiligen Zertifikate und statischen Berechnungen.

VSG gemäss Statik

Anker: ■457 - 463

Glasleistenrohre

Wandflansche

Rechteckig □

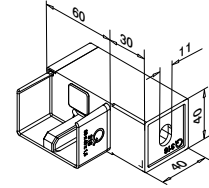
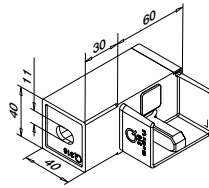

MOD 6508

V4A	316	Gebürstet		
	OUTDOOR			
146508-640-01	60 x 40	■ 457 - 463	2	

NEW

MOD 6508

V4A	316	Gebürstet		
	OUTDOOR			
146508-640-02	60 x 40	■ 457 - 463	2	

NEW

Glasleistenrohre

Glasleistenrohre

Rechteckig □

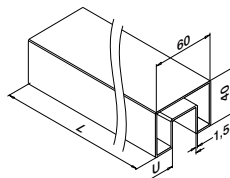

MOD 6924

V4A	316	Gebürstet		
	OUTDOOR			
146924-640-50-12	24	60 x 40	L = 5 m	

PREFIX



Glasleistenrohre

Gummieinlagen

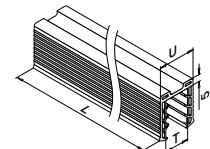

MOD 5124

Zubehör

U = 24 mm		
Für monolithisches Glas	T	
205124-050-08	8 - 10	L = 5 m
205124-050-11	12	L = 5 m
205124-050-15	15	L = 5 m
205124-050-19	19	L = 5 m

Für laminiertes Glas

205124-050-08	8,76 - 10,76	L = 5 m
205124-050-11	11,52 - 13,52	L = 5 m
205124-050-17	16,76 - 17,52	L = 5 m
NEW 205124-050-92	20,76 - 21,52	L = 5 m

Q-INFO

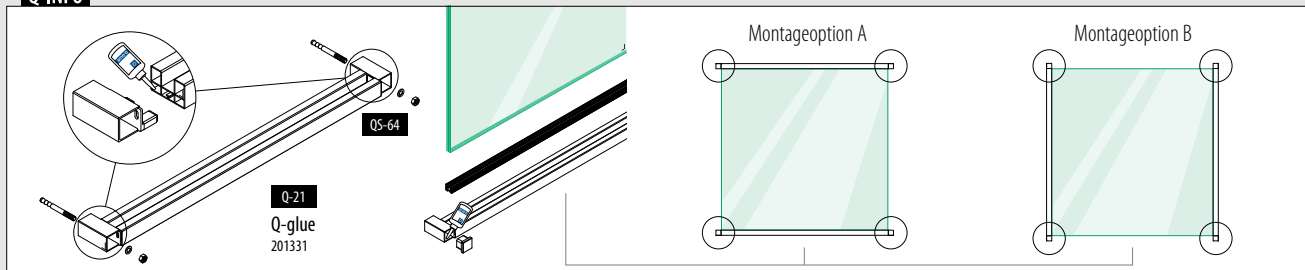

Easy Glass® MOD 6505

Montage in der Fensterlaibung

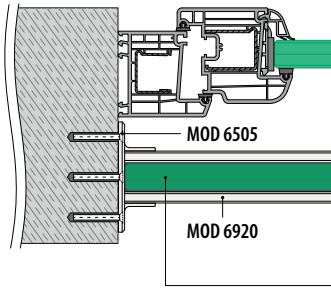

Bitte beachten Sie die Spezifikationen wie Befestigungs- und Glasmasse sowie Glas-typen der jeweiligen Zertifikate und statischen Berechnungen.

VSG gemäss Statik

Wandflansche

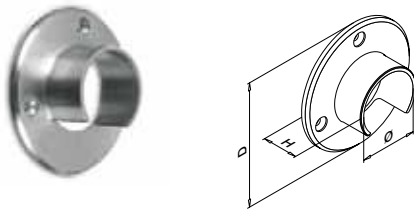

MOD 6505

V4A	316	Gebürstet				
OUTDOOR			Ø	D	H	
146505-042-12	42,4	90	30	QS-6	471	2



Glasleistenrohre

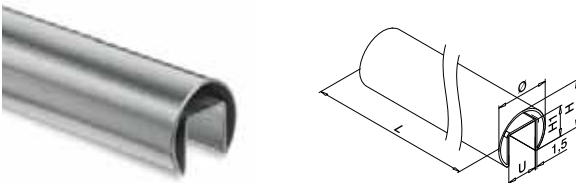

MOD 6920

V4A	316	Gebürstet				
OUTDOOR			U	Ø	H	H1
146920-042-50-12	24	42,4	37	24	L = 5 m	



Gummieinlagen



MOD 5124

Zubehör

U = 24 mm

Für monolithisches Glas	T	
205124-050-08	8 - 10	L = 5 m
205124-050-11	12	L = 5 m
205124-050-15	15	L = 5 m
205124-050-19	19	L = 5 m
205124-250-08	8 - 10	L = 25 m
205124-250-11	12	L = 25 m
SELL OUT 205124-250-15	15	L = 25 m
SELL OUT 205124-250-19	19	L = 25 m

Für laminiertes Glas

205124-050-08	8,76 - 10,76	L = 5 m
205124-050-11	11,52 - 13,52	L = 5 m
205124-050-17	16,76 - 17,52	L = 5 m
NEW 205124-050-92	20,76 - 21,52	L = 5 m
205124-250-08	8,76 - 10,76	L = 25 m
205124-250-11	11,52 - 13,52	L = 25 m
205124-250-17	16,76 - 17,52	L = 25 m
NEW 205124-250-92	20,76 - 21,52	L = 25 m

SELL OUT Nur solange der Vorrat reicht.

Q-INFO MOD 6920

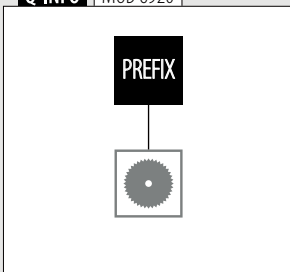

Montage in der Fensterlaibung

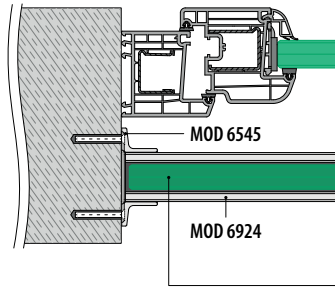

Bitte beachten Sie die Spezifikationen wie Befestigungs- und Glasmasse sowie Glas-typen der jeweiligen Zertifikate und statischen Berechnungen.

VSG gemäss Statik

Wandflansche

Quadratisch

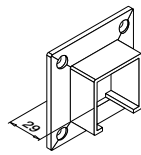
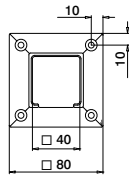

MOD 6545

V4A	316	Gebürstet		
OUTDOOR		<input type="checkbox"/>		
146545-040-12	40 x 40	QS-50	471	2



Glasleistenrohre

Quadratisch

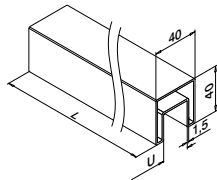

MOD 6924

V4A	316	Gebürstet		
OUTDOOR		<input type="checkbox"/>		
146924-040-50-12	24	40 x 40		L = 5 m

PREFIX



Gummieinlagen

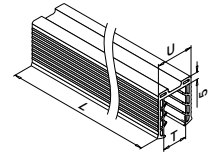

MOD 5124

Zubehör		
U = 24 mm		
Für monolithisches Glas	T	
205124-050-08	8 - 10	L = 5 m
205124-050-11	12	L = 5 m
205124-050-15	15	L = 5 m
205124-050-19	19	L = 5 m

Für laminiertes Glas		
205124-050-08	8,76 - 10,76	L = 5 m
205124-050-11	11,52 - 13,52	L = 5 m
205124-050-17	16,76 - 17,52	L = 5 m
NEW 205124-050-92	20,76 - 21,52	L = 5 m

Q-INFO MOD 6924

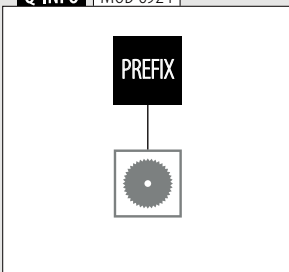

Easy Glass® MOD 6545

Montage in der Fensterlaibung

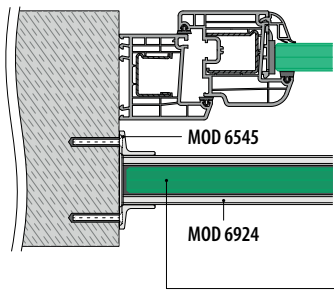

Bitte beachten Sie die Spezifikationen wie Befestigungs- und Glasmasse sowie Glas-typen der jeweiligen Zertifikate und statischen Berechnungen.

VSG gemäss Statik

Wandflansche

Rechteckig

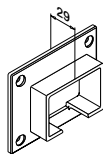
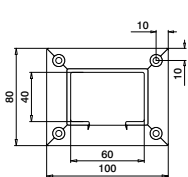

MOD 6545

V4A	316	Gebürstet	<input type="checkbox"/>		
OUTDOOR					
146545-640-12	60 x 40	QS-50	471	2	



Glasleistenrohre

Rechteckig

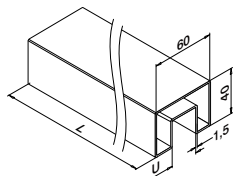

MOD 6924

V4A	316	Gebürstet	<input type="checkbox"/>		
OUTDOOR					
146924-640-50-12	24	60 x 40	L = 5 m		



Q-INFO MOD 6924

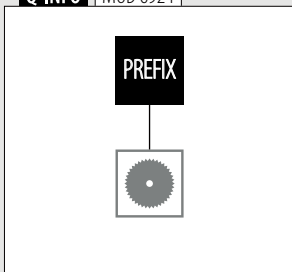

Easy Glass® MOD 6504

Montage in der Fensterlaibung

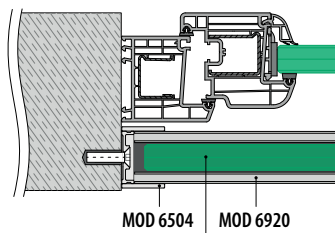

Bitte beachten Sie die Spezifikationen wie Befestigungs- und Glasmasse sowie Glas-typen der jeweiligen Zertifikate und statischen Berechnungen.

VSG gemäss Statik

Wandflansche

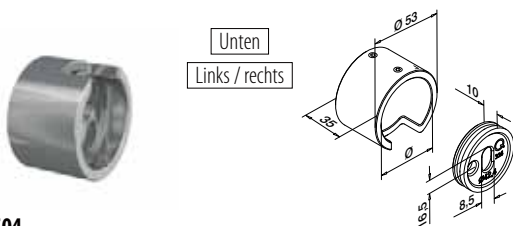

MOD 6504

Aluminium	Roh	Ø	
166504-042-00-00		42,4	2
Aluminium	Gebürstet		
OUTDOOR			
166504-042-00-18		42,4	2

NEW

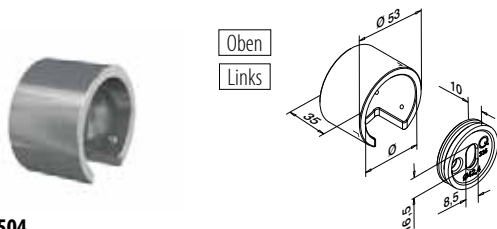

MOD 6504

Aluminium	Roh	Ø	
166504-042-01-00		42,4	2
Aluminium	Gebürstet		
OUTDOOR			
166504-042-01-18		42,4	2

NEW

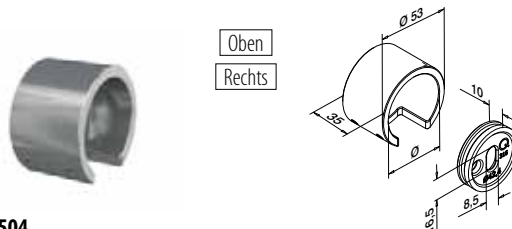

MOD 6504

Aluminium	Roh	Ø	
166504-042-02-00		42,4	2
Aluminium	Gebürstet		
OUTDOOR			
166504-042-02-18		42,4	2

NEW

Q-INFO Aluminium

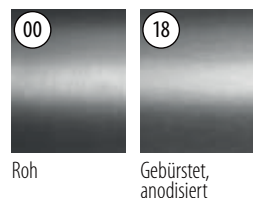

Roh

Gebürstet,
anodisiert

Glasleistenrohre

166920-042-50-00 18

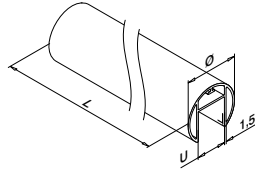

MOD 6920

Aluminium Roh	U	Ø	L = 5 m
166920-042-50-00	24	42,4	L = 5 m
Aluminium Gebürstet			
OUTDOOR			
166920-042-50-18	24	42,4	L = 5 m



Internationaler Geschmacksmusterschutz

Gummieinlagen

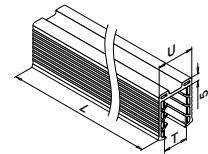

MOD 5124

Zubehör

U = 24 mm

Für monolithisches Glas	T	L = 5 m
205124-050-08	8 - 10	L = 5 m
205124-050-11	12	L = 5 m
205124-050-15	15	L = 5 m
205124-050-19	19	L = 5 m
205124-250-08	8 - 10	L = 25 m
205124-250-11	12	L = 25 m
205124-250-15	15	L = 25 m
205124-250-19	19	L = 25 m

SELL
OUT
SELL
OUT

Für laminiertes Glas

205124-050-08	8,76 - 10,76	L = 5 m
205124-050-11	11,52 - 13,52	L = 5 m
205124-050-17	16,76 - 17,52	L = 5 m
NEW 205124-050-92	20,76 - 21,52	L = 5 m
205124-250-08	8,76 - 10,76	L = 25 m
205124-250-11	11,52 - 13,52	L = 25 m
205124-250-17	16,76 - 17,52	L = 25 m
NEW 205124-250-92	20,76 - 21,52	L = 25 m

Q-INFO MOD 6920

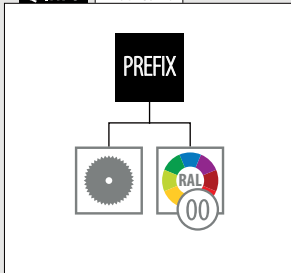

Q-INFO

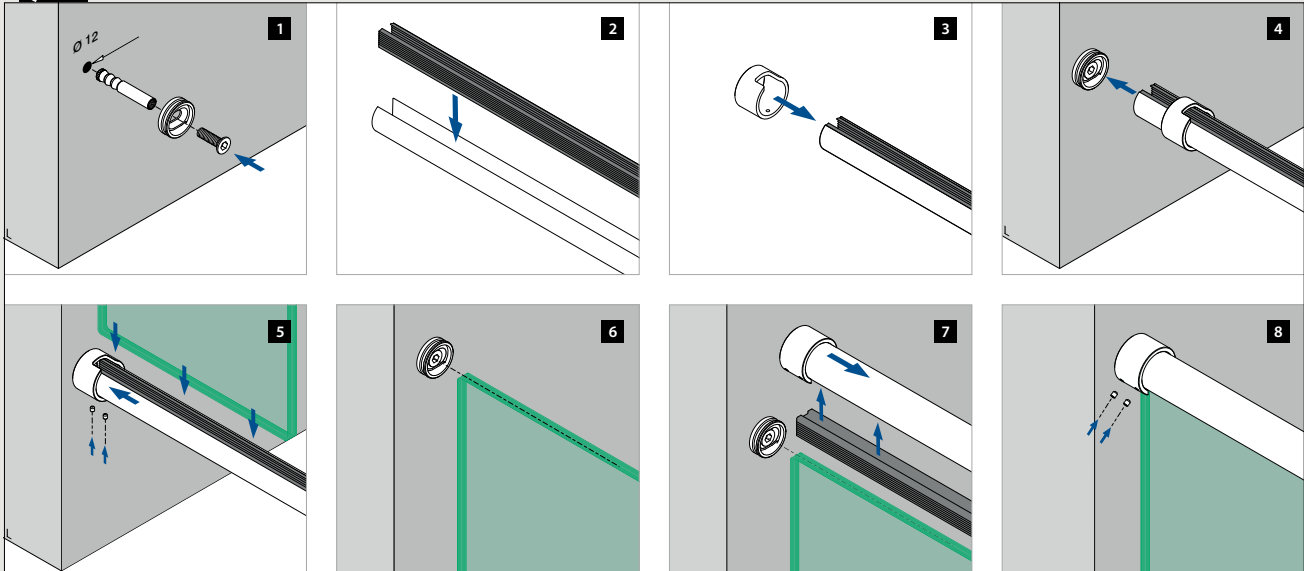



FRANZÖSISCHE BALKONE MIT GLASKLEMMEN



Glasklemmen - MOD 2300

Montage in der Fensterlaibung

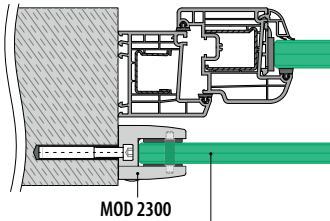

Bitte beachten Sie die Spezifikationen wie Befestigungs- und Glasmasse sowie Glas-typen der jeweiligen Zertifikate und statischen Berechnungen.

VSG gemäss Statik

Glasklemmen - MOD 2300

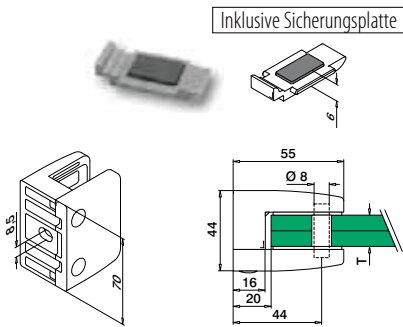

Inklusive Sicherungsplatte

MOD 2300

V4A 316 Gebürstet

OUTDOOR T Siehe T in MOD 5023 QS-27 472 4



Gummieinlagen für MOD 2300



2 Stück pro Glasklemme

MOD 5023

Zubehör

Für monolithisches Glas		
	T	
NEW 205023-12	12	8
NEW 205023-15	15	8
205023-19	19	8

Für laminiertes Glas

NEW 205023-44	9,52	8
NEW 205023-54	11,52	8
NEW 205023-13	12,76	8
NEW 205023-64	13,52	8
NEW 205023-17	16,76	8
NEW 205023-18	17,52	8
205023-21	20,76	8
205023-22	21,52	8

Sicherungsstifte

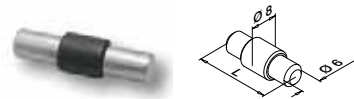

Optional verwendbar für MOD 2300

MOD 5015

Zubehör

	L	
205015-23	34	4

Q-INFO MOD 2300

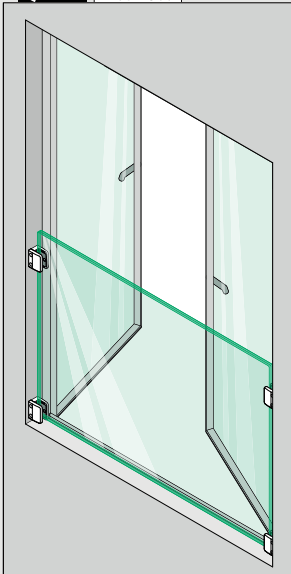

Q-INFO MOD 2300

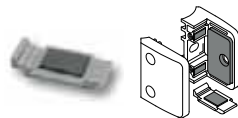

Verwenden Sie die Sicherungsplatte anstelle des Sicherungsstiftes. Das spart Ihnen Zeit und Kosten, weil Löcher im Glas nicht notwendig sind.

Q-INFO MOD 5015

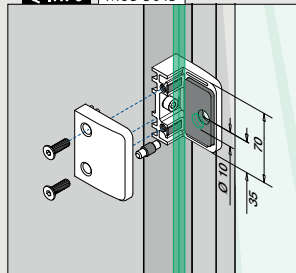

Bitte bestellen Sie Befestigungsmaterial separat.



FRANZÖSISCHE BALKONE MIT GLASADAPTERN

Fassadenmontage

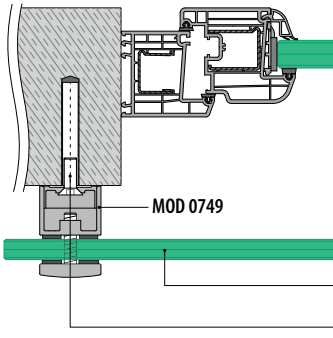

Bitte beachten Sie die Spezifikationen wie Befestigungs- und Glasmasse sowie Glas-typen der jeweiligen Zertifikate und statischen Berechnungen.

VSG gemäss Statik

Anker: ■ 457 - 463

Punktförmige Glasadapter

Justierbar

Ø 50

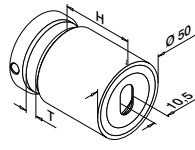

MOD 0749

V4A	316	Gebürstet			
OUTDOOR			H	T	
	140749-030-12		30	12 - 25,52	■ 457 - 463 2
	140749-040-12		40	8 - 25,52	■ 457 - 463 2
	140749-050-12		50	8 - 25,52	■ 457 - 463 2
	140749-100-12		100	8 - 25,52	■ 457 - 463 2

V4A	316	Black Line			
OUTDOOR					
NEW	140749-030-82		30	12 - 25,52	■ 457 - 463 2
NEW	140749-040-82		40	8 - 25,52	■ 457 - 463 2
NEW	140749-050-82		50	8 - 25,52	■ 457 - 463 2



Einlagen für Glasadapter

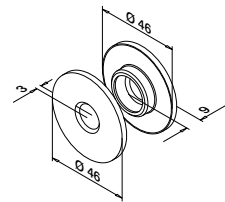

MOD 5030

Zubehör	Für MOD	
205030-150-99-80	0749	4

NEW

Q-INFO

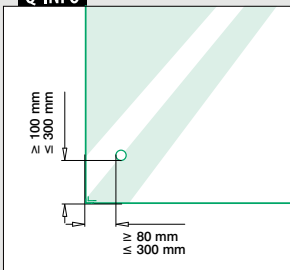

Q-INFO



Q-INFO

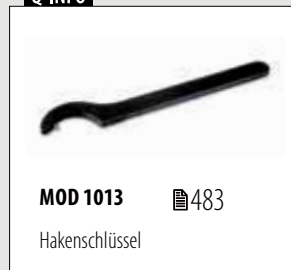

Fassadenmontage

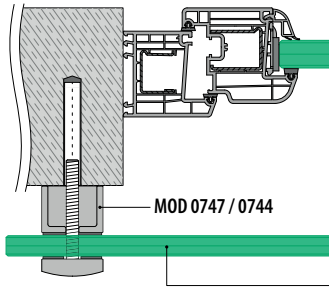

Bitte beachten Sie die Spezifikationen wie Befestigungs- und Glasmasse sowie Glas-typen der jeweiligen Zertifikate und statischen Berechnungen.

VSG gemäss Statik

Geländerbasis

Punktförmige Glasadapter

Ø 50

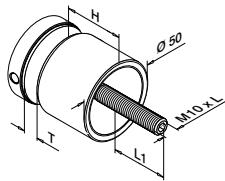

MOD 0747

V4A	316	Gebürstet					
OUTDOOR			H	T	L	L1	
140747-010-12	10	8 - 17,52	50	11 - 20	2		
140747-020-12	20	8 - 25,52	70	13 - 31	2		
140747-030-12	30	8 - 25,52	80	13 - 31	2		
140747-040-12	40	8 - 17,52	80	11 - 21	2		
140747-050-12	50	8 - 17,52	90	11 - 21	2		

V4A	316	Black Line					
OUTDOOR							
NEW	140747-010-82	10	8 - 17,52	50	11 - 20	2	
NEW	140747-030-82	30	8 - 25,52	80	13 - 31	2	

Zinkdruckguss Edelstahl-effekt

SELL OUT	OUTDOOR					
100747-20	10	8 - 17,52	50	11 - 20	2	

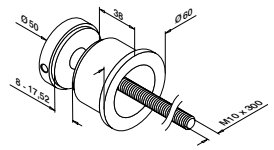

MOD 0744

V4A	316	Gebürstet			
OUTDOOR					
140744-12					2



* Auch für Aussenanwendung geeignet bei entsprechenden Bedingungen.

Q-INFO MOD 0747

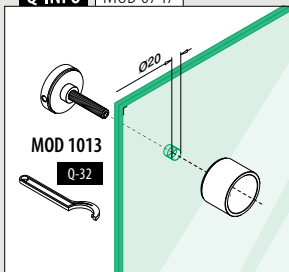

Q-INFO MOD 0747

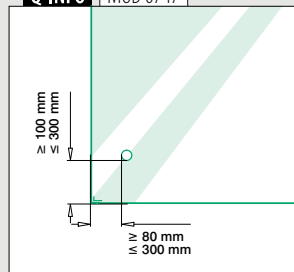

Q-INFO MOD 0744

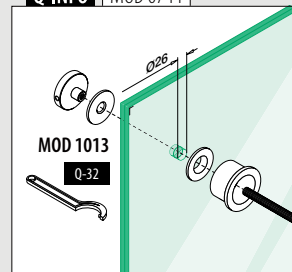

Q-INFO 316



Punktförmige Glasadapter

Ø 60

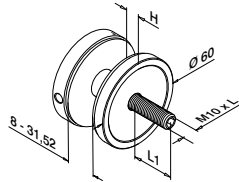

MOD 0745

V4A	316	Gebürstet			
	OUTDOOR	H	L	L1	
	140745-010-12	10	70	17 - 41	2

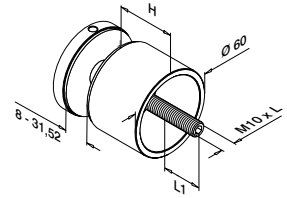

MOD 0745

V4A	316	Gebürstet			
	OUTDOOR	H	L	L1	
	140745-030-12	30	90	17 - 41	2
	140745-050-12	50	110	17 - 41	2



Punktförmige Glasadapter

Ø 70

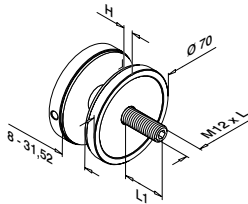

MOD 0748

V4A	316	Gebürstet			
	OUTDOOR	H	L	L1	
	140748-010-12	10	70	17 - 41	2

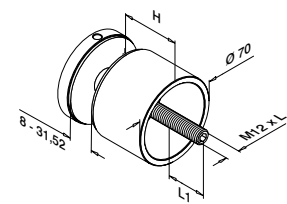

MOD 0748

V4A	316	Gebürstet			
	OUTDOOR	H	L	L1	
	140748-030-12	30	90	17 - 41	2
	140748-040-12	40	100	17 - 41	2



Q-INFO MOD 0745 / 0748

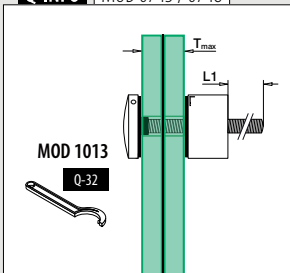

Q-INFO MOD 0745-010

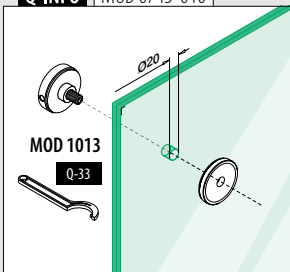

Q-INFO MOD 0745-030 / 050

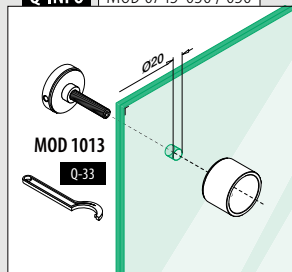

Q-INFO MOD 0748-010

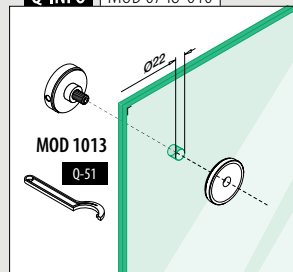

Q-INFO MOD 0748-030 / 040

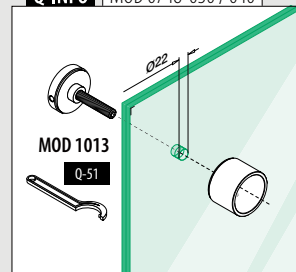

Fassadenmontage

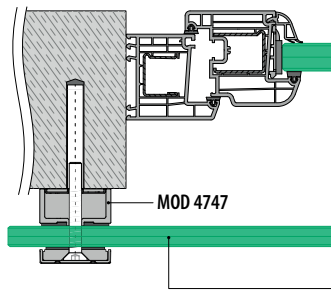

Bitte beachten Sie die Spezifikationen wie Befestigungs- und Glasmasse sowie Glas-typen der jeweiligen Zertifikate und statischen Berechnungen.

VSG gemäss Statik

Punktförmige Glasadapter

Quadratisch □

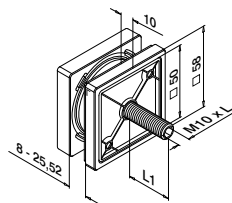

MOD 4747

V4A	316	Gebürstet		
	OUTDOOR	L	L1	
144747-010-12	60	13 - 31	2	



Internationaler Geschmacksmusterschutz

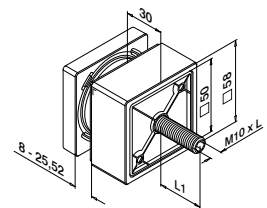

MOD 4747

V4A	316	Gebürstet		
	OUTDOOR	L	L1	
144747-030-12	80	13 - 31	2	



Internationaler Geschmacksmusterschutz

Nicht nach SIA-Norm geprüft, interne Prüfberichte stehen auf Anfrage zur Verfügung.

Q-INFO

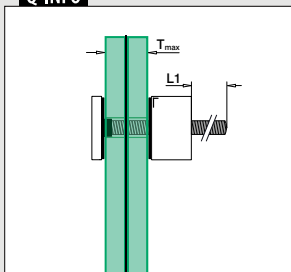

Q-INFO

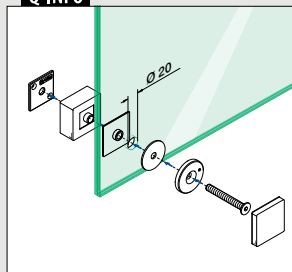

Q-INFO

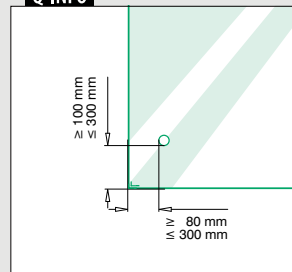

Easy Glass® MOD 0763

Fassadenmontage

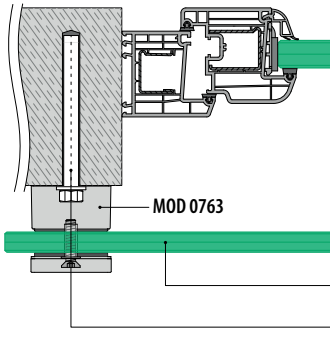

Bitte beachten Sie die Spezifikationen wie Befestigungs- und Glasmasse sowie Glas-typen der jeweiligen Zertifikate und statischen Berechnungen.

VSG gemäss Statik

Anker: 457 - 463

Blockförmige Glasadapter

Rechteckig □

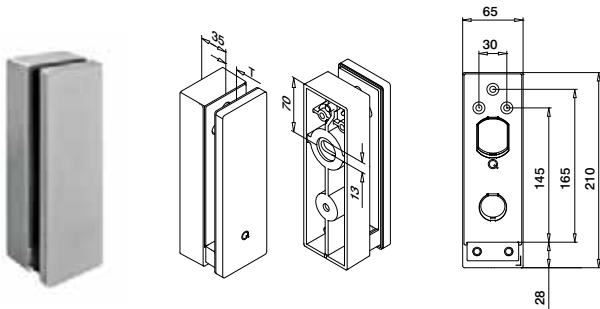

MOD 0763

V4A	316	Gebürstet		
	OUTDOOR	T		
140763-12		12 - 21,52	457 - 463	1



Internationaler Geschmacksmusterschutz

Q-INFO

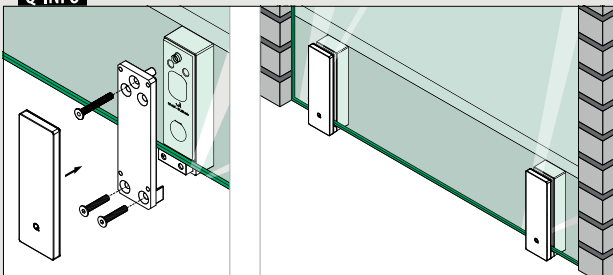

Q-INFO

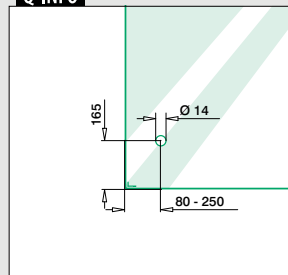



FENSTERABSTURZ- STANGEN

Absturztangen 20x10 - MOD 4828

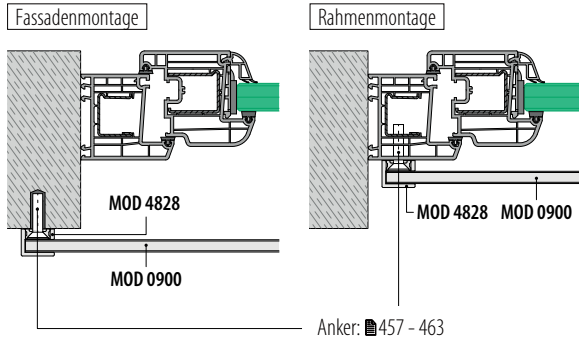

Absturztangen 20x10 - MOD 4827

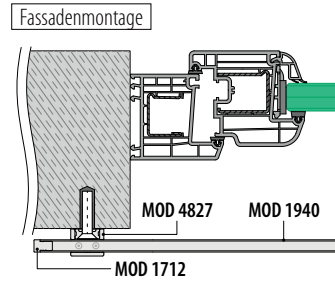

Bitte beachten Sie die Spezifikationen wie zum Beispiel Befestigungsmasse der jeweiligen Zertifikate und statischen Berechnungen.

Querstabhalter

Rechteckig

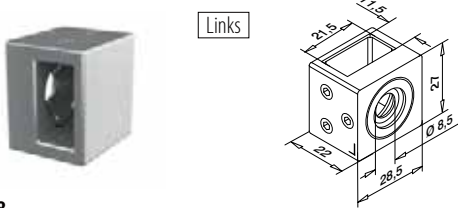

MOD 4828

V4A	316	Gebürstet			
OUTDOOR	Für Rohr	<input type="checkbox"/>			
144828-01-12	20 x 10 x 1,0	QS-20	472	4	

NEW

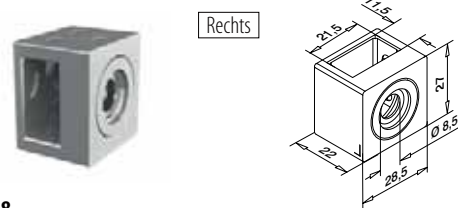

MOD 4828

V4A	316	Gebürstet			
OUTDOOR	Für Rohr	<input type="checkbox"/>			
144828-02-12	20 x 10 x 1,0	QS-20	472	4	

NEW

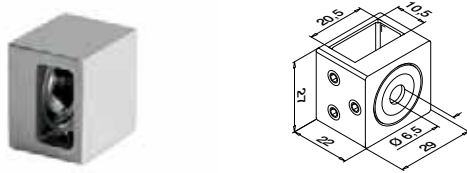

MOD 4827

V4A	316	Gebürstet			
OUTDOOR	Für Rohr	<input type="checkbox"/>			
144827-12	20 x 10 x 1,0	QS-16	472	4	



Internationaler Geschmacksmusterschutz

Endkappen

Rechteckig



In Kombination mit MOD 4827 und MOD 1940

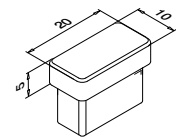

MOD 1712

V4A	316	Gebürstet			
OUTDOOR	Für Rohr	<input type="checkbox"/>			
141712-021-12	20 x 10 x 1,0			4	



Internationaler Geschmacksmusterschutz

Rohre

Q-TUBE

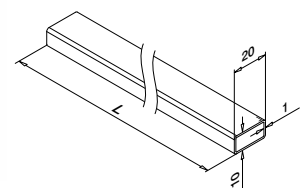

MOD 1940

V4A	316	Gebürstet			
OUTDOOR	Für Rohr	<input type="checkbox"/>			
141940-021-50-12	20 x 10 x 1,0			L = 5 m	

PREFIX



Q-INFO MOD 4828

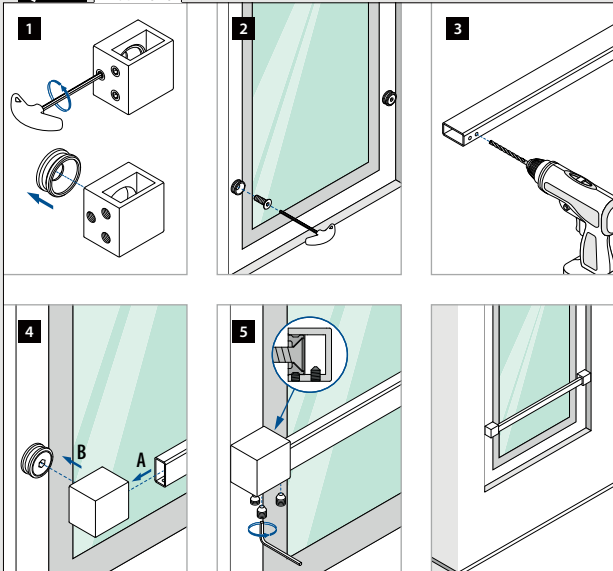

Absturzstangen 40x40 - MOD 6518

Fassadenmontage

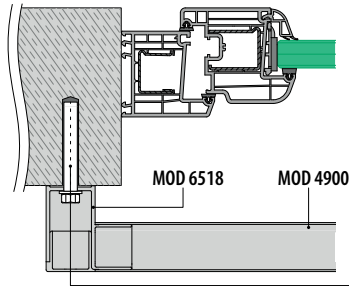

Rahmenmontage

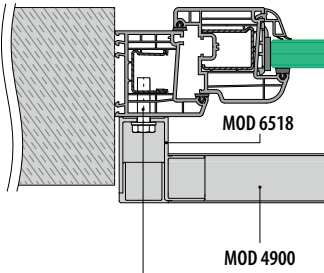

Bitte beachten Sie die Spezifikationen wie zum Beispiel Befestigungsmasse der jeweiligen Zertifikate und statischen Berechnungen.

Anker: ■457 - 463

Wandflansche

Quadratisch □

Links / rechts

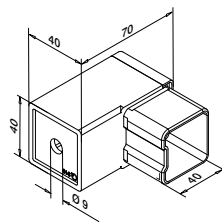

MOD 6518

V4A	316	Gebürstet		
	OUTDOOR	Für Rohr □		
146518-040-12	40 x 40 x 2,0	■457 - 463	2	

NEW

Rohre

Q-TUBE

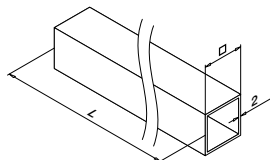

MOD 4900

V4A	316	Gebürstet		
	OUTDOOR	□		
144900-040-50-12	40 x 40 x 2,0	L = 5 m		

PREFIX



Q-INFO

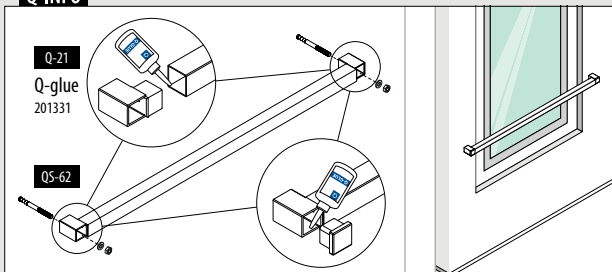

Q-INFO MOD 4900

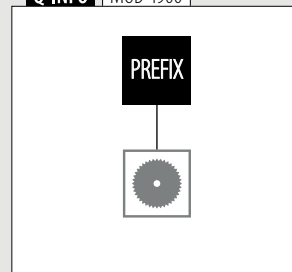

Glasleistenrohre

Absturzstangen 40x40 - MOD 4507

Fassadenmontage

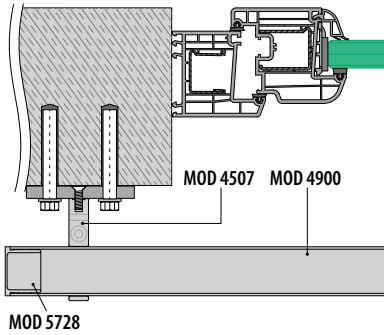

Bitte beachten Sie die Spezifikationen wie zum Beispiel Befestigungsmasse der jeweiligen Zertifikate und statischen Berechnungen.

Glasleistenrohre

Absturzstangen 40x40 - MOD 4505

Montage in der Fensterlaibung

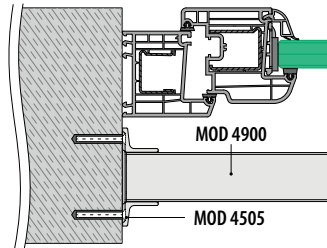

Bitte beachten Sie die Spezifikationen wie zum Beispiel Befestigungsmasse der jeweiligen Zertifikate und statischen Berechnungen.

Glasleistenrohre

Rohrhalter

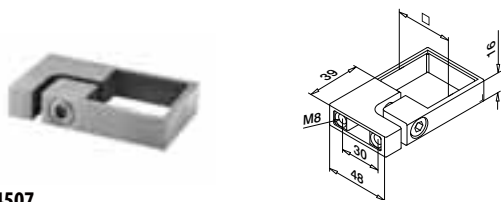

MOD 4507

V4A	316	Gebürstet		
OUTDOOR		<input type="checkbox"/>		
144507-040-12	40 x 40	QS-20	472	2
NEW				

Handläufe

Wandflansche

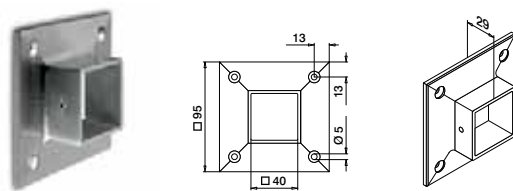

MOD 4505

V4A	316	Gebürstet		
OUTDOOR		<input type="checkbox"/>		
144505-040-12	40 x 40	QS-6	471	2

Handläufe

Rohre

Q-TUBE

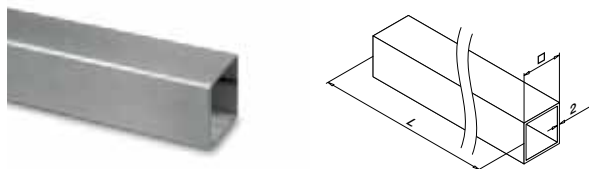

MOD 4900

V4A	316	Gebürstet		
OUTDOOR		<input type="checkbox"/>		
144900-040-50-12	40 x 40 x 2,0			L = 5 m
PREFIX				

Handläufe

Endkappen



In Kombination mit MOD 4507 und MOD 4900

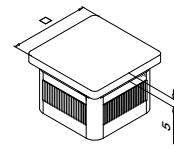

MOD 5728 - EASY HIT®

V4A	316	Gebürstet		
OUTDOOR		<input type="checkbox"/>	<input type="checkbox"/>	
145728-040-12	Für Rohr 40 x 40 x 2,0			2

Q-INFO MOD 4900

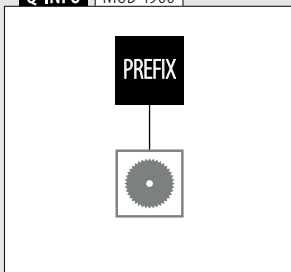

Fassadenmontage

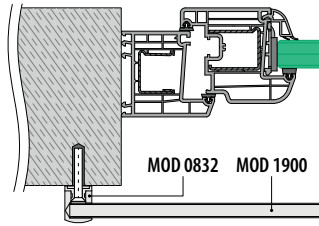

Rahmenmontage

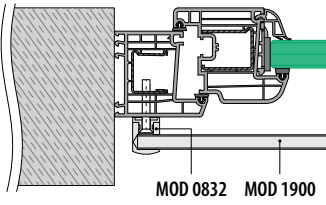

Bitte beachten Sie die Spezifikationen wie zum Beispiel Befestigungsmasse der jeweiligen Zertifikate und statischen Berechnungen.

Füllungen

Stabhalter



Links

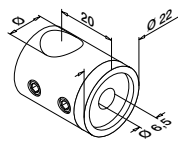

Rechts

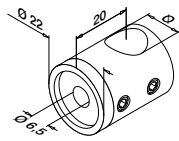

MOD 0832

V4A	316	Gebürstet		
	OUTDOOR	Ø		
140832-000-12	12	QS-16	4	



MOD 0833

V4A	316	Gebürstet		
	OUTDOOR	Ø		
140833-000-12	12	QS-16	4	

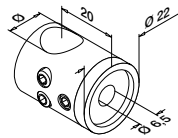

MOD 0831

V4A	316	Gebürstet		
	OUTDOOR	Ø		
140831-000-12	12	QS-16	4	



Füllungen

Endkappen



In Kombination mit MOD 0831 und MOD 1900

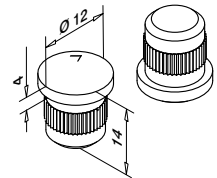

MOD 1759 - EASY HIT®

V4A	316	Gebürstet		
	OUTDOOR			
141759-112-12			4	

NEW

Q-INFO MOD 1759

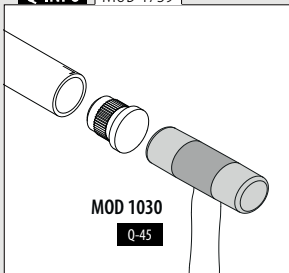

Q-INFO

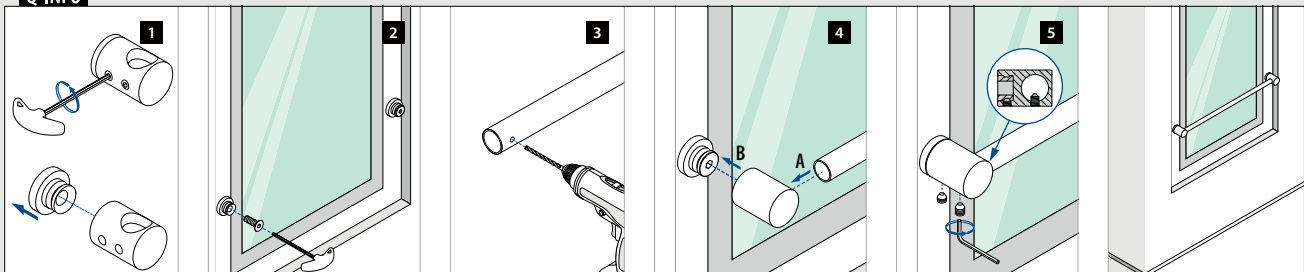

Absturzstangen Ø12 - MOD 0504

Montage in der Fensterlaibung

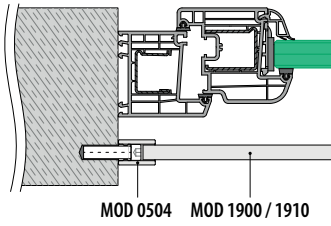

Bitte beachten Sie die Spezifikationen wie zum Beispiel Befestigungsmasse der jeweiligen Zertifikate und statischen Berechnungen.

Handläufe

Wandflansche

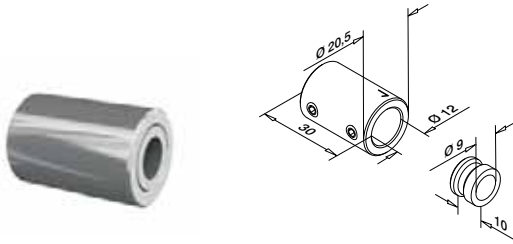

MOD 0504

V4A	316	Gebürstet		
OUTDOOR				
140504-012-12	QS-27	472		2

NEW

Füllungen

Stäbe

Q-TUBE

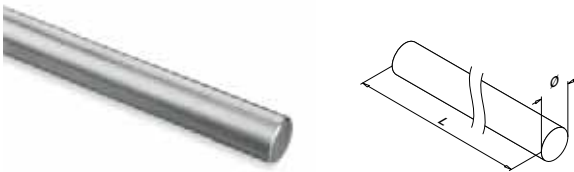

MOD 1910

V4A	316	Gebürstet		
OUTDOOR				
141910-012-25-12	12		L = 2,5 m	
141910-012-50-12	12		L = 5 m	

PREFIX



Füllungen

Rohre

Q-TUBE

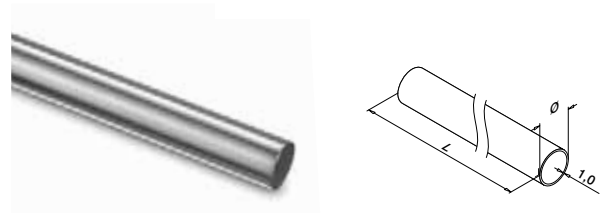

MOD 1900

V4A	316	Gebürstet		
OUTDOOR				
141900-012-50-12	12		L = 5 m	

NEW

PREFIX



Q-INFO MOD 0504

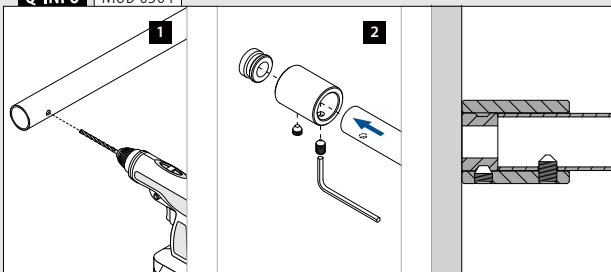

Q-INFO MOD 1900 / 1910

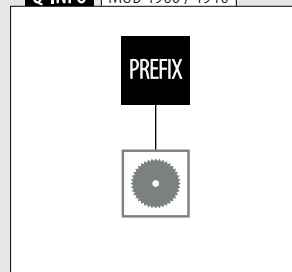

Absturzstangen Ø16 - MOD 0504

Montage in der Fensterlaibung

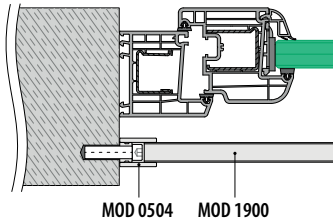

Bitte beachten Sie die Spezifikationen wie zum Beispiel Befestigungsmasse der jeweiligen Zertifikate und statischen Berechnungen.

MOD 0504 MOD 1900

Handläufe

Wandflansche

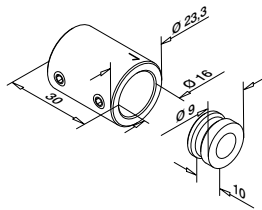

MOD 0504

V4A	316	Gebürstet		
OUTDOOR				
140504-016-12	QS-27	472		2

NEW

Füllungen

Rohre

Q-TUBE

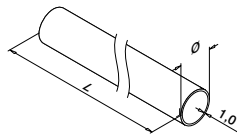

MOD 1900

V4A	316	Gebürstet	Ø	
OUTDOOR				
141900-016-50-12	16			L = 5 m



Q-INFO

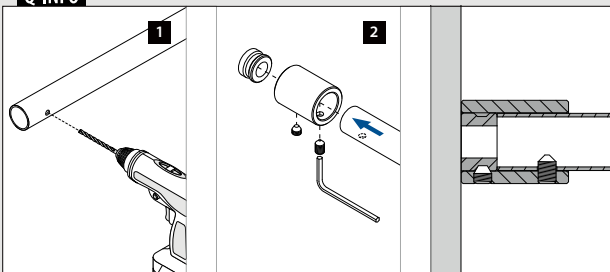

Q-INFO MOD 1900

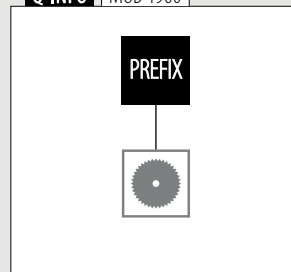

Absturzstangen Ø16 - MOD 0842 / 0843

Fassadenmontage

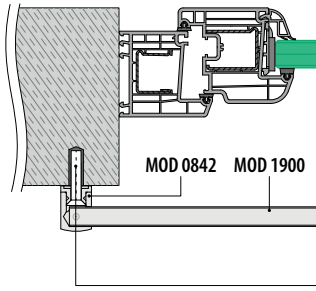

Rahmenmontage

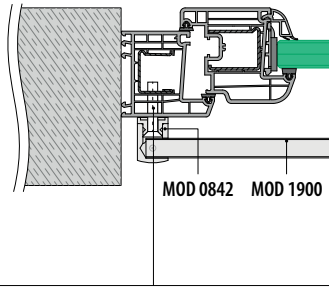

Bitte beachten Sie die Spezifikationen wie zum Beispiel Befestigungsmasse der jeweiligen Zertifikate und statischen Berechnungen.

Anker: ■457 - 463

Handläufe

Wandflansche



Links

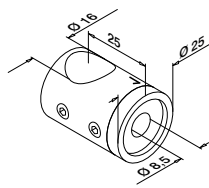

MOD 0842

V4A	316	Gebürstet		
OUTDOOR				
140842-000-12	QS-22	■472		4

NEW



Rechts

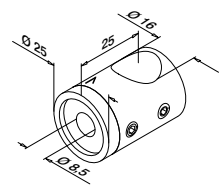

MOD 0843

V4A	316	Gebürstet		
OUTDOOR				
140843-000-12	QS-22	■472		4

NEW

Füllungen

Rohre

Q-TUBE

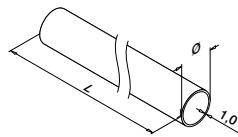

MOD 1900

V4A	316	Gebürstet		
OUTDOOR		Ø		
141900-016-50-12	16			L = 5 m

PREFIX



Füllungen

Endkappen

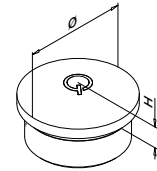

MOD 1729

V4A	316	Gebürstet		
OUTDOOR		Für Rohr Ø	H	
141729-016-12	16,0 x 1,0	4		2



Q-INFO | MOD 0842 / 0843

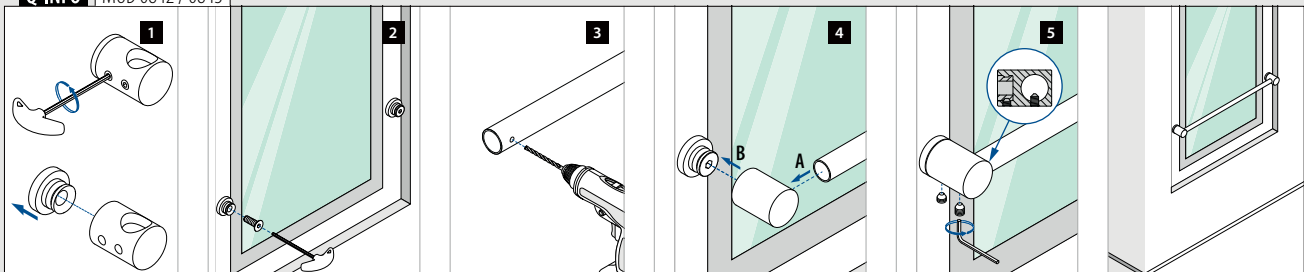

Glasleistenrohre

Absturzstangen Ø33,7 - MOD 0504

Montage in der Fensterlaibung

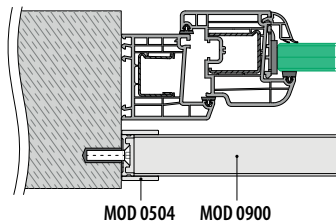

Bitte beachten Sie die Spezifikationen wie zum Beispiel Befestigungsmasse der jeweiligen Zertifikate und statischen Berechnungen.

Glasleistenrohre

Absturzstangen Ø33,7 - MOD 0505 / 0506

Montage in der Fensterlaibung

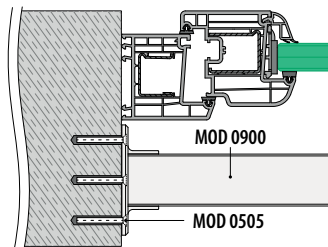

Bitte beachten Sie die Spezifikationen wie zum Beispiel Befestigungsmasse der jeweiligen Zertifikate und statischen Berechnungen.

Handläufe

Wandflansche

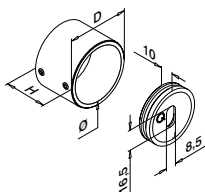

MOD 0504

V4A	316	Gebürstet						
	OUTDOOR	Ø	D	H				
140504-033-12		33,7	41	30	QS-55	470 / QS-22	472	2

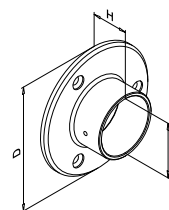

MOD 0505

V4A	316	Gebürstet						
	OUTDOOR	Für Rohr Ø	D	H				
140505-033-12		33,7	85	30	QS-50	471		2



Handläufe

Wandflansche

Justierbar



0 - 50°

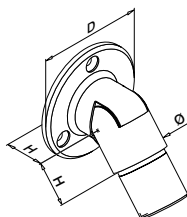

MOD 0506

V4A	316	Gebürstet						
	OUTDOOR	Für Rohr Ø	D	H				
140506-033-12		33,7 x 2,0	70	26	QS-50	471		2



Internationaler Geschmacksmusterschutz

Handläufe

Rohre

Q-TUBE

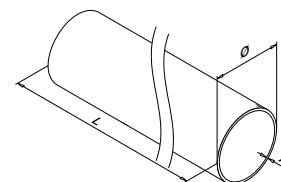

MOD 0900

V4A	316	Gebürstet						
	OUTDOOR	Ø	X					
140900-233-50-12		33,7	2,0				L = 5 m	



Q-INFO MOD 0504

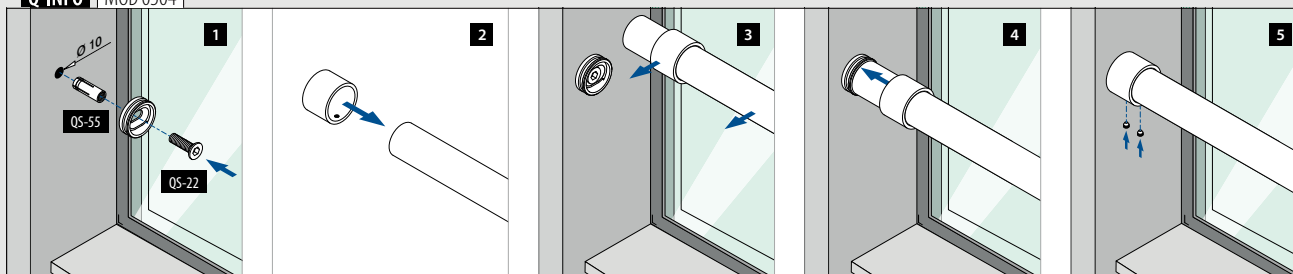

Absturzstangen Ø33,7 - MOD 6517

Fassadenmontage

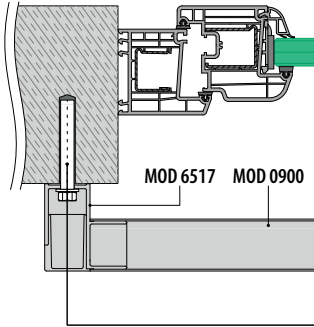

Rahmenmontage

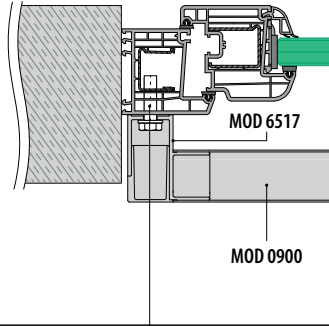

Bitte beachten Sie die Spezifikationen wie zum Beispiel Befestigungsmasse der jeweiligen Zertifikate und statischen Berechnungen.

Anker: ■457 - 463

Handläufe

Wandflansche

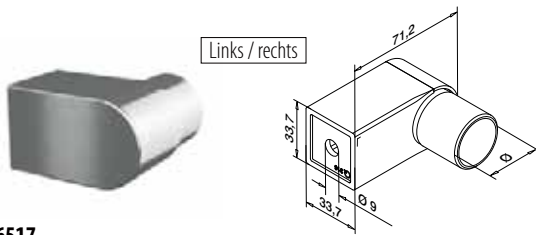

MOD 6517

V4A	316	Gebürstet		
	OUTDOOR	Für Rohr Ø		
146517-233-12		33,7 x 2,0	QS-27 ■472	2

NEW

Handläufe

Rohre

Q-TUBE

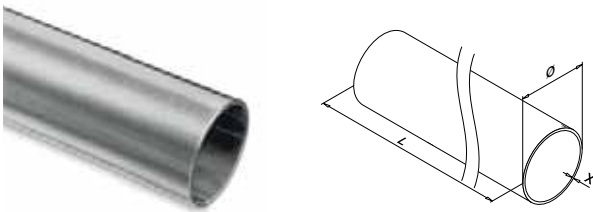

MOD 0900

V4A	316	Gebürstet		
	OUTDOOR	Ø	X	
140900-233-50-12		33,7	2,0	L = 5 m



Q-INFO

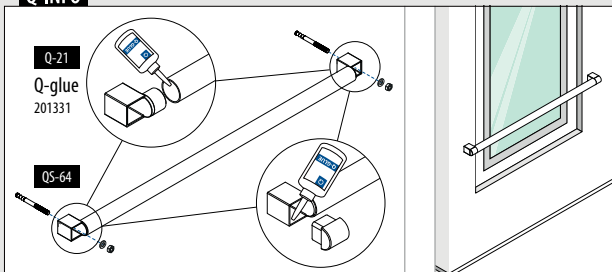

Q-INFO MOD 0900

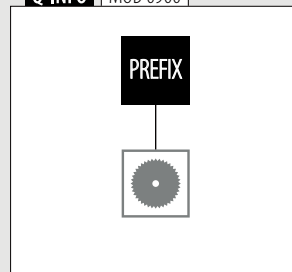

Absturzstangen Ø33,7 - MOD 0523

Fassadenmontage

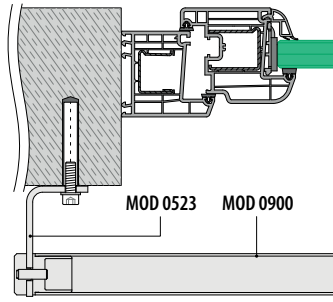

Bitte beachten Sie die Spezifikationen wie zum Beispiel Befestigungsmasse der jeweiligen Zertifikate und statischen Berechnungen.

Handläufe

Wandflansche

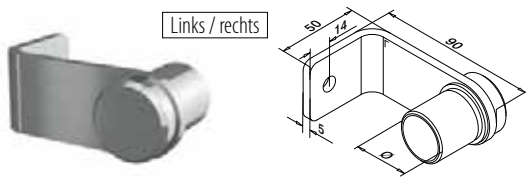

MOD 0523

V4A	316	Gebürstet		
	OUTDOOR	Für Rohr Ø		
140523-033-12		33,7 x 2,0	QS-30 472	2

NEW

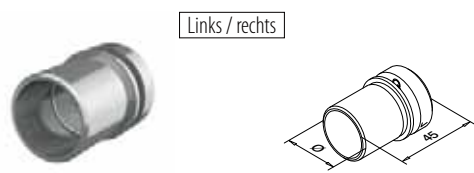

MOD 3523

V4A	316	Gebürstet		
	OUTDOOR	Für Rohr Ø		
143523-033-12		33,7 x 2,0		2

NEW

Handläufe

Rohre

Q-TUBE

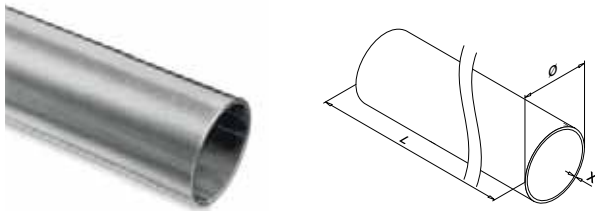

MOD 0900

V4A	316	Gebürstet		
	OUTDOOR	Ø	X	
140900-233-50-12		33,7	2,0	L = 5 m



Q-INFO MOD 0523

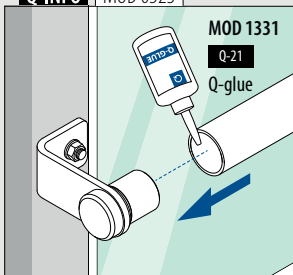

Q-INFO MOD 0900

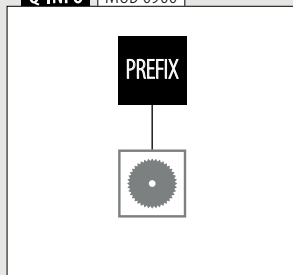

Absturztangen Ø42,4 - MOD 0504

Montage in der Fensterlaibung

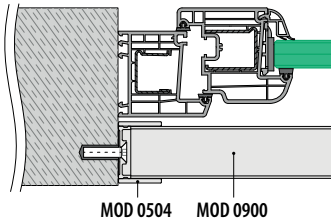

Bitte beachten Sie die Spezifikationen wie zum Beispiel Befestigungsmasse der jeweiligen Zertifikate und statischen Berechnungen.

Absturztangen Ø42,4 - MOD 0505

Montage in der Fensterlaibung

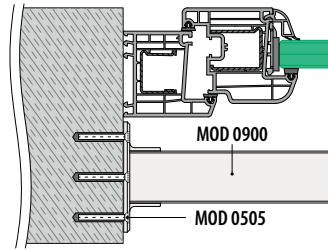

Bitte beachten Sie die Spezifikationen wie zum Beispiel Befestigungsmasse der jeweiligen Zertifikate und statischen Berechnungen.

Wandflansche

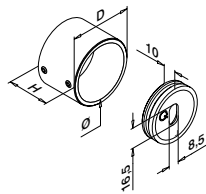

MOD 0504

V4A	316	Gebürstet					
	OUTDOOR	Ø	D	H			
140504-042-12		42,4	50	35	QS-55	470 / QS-22	472 2

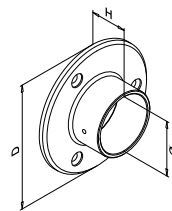

MOD 0505

V4A	316	Gebürstet					
	OUTDOOR	Für Rohr Ø	D	H			
140505-042-12		42,4	95	30	QS-50	471	2



Wandflansche

Justierbar



0 - 50°

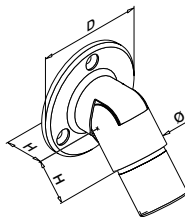

MOD 0506

V4A	316	Gebürstet					
	OUTDOOR	Für Rohr Ø	D	H			
140506-042-12		42,4 x 2,0	75	30	QS-50	471	2

NEW



Internationaler Geschmacksmusterschutz

Rohre

Q-TUBE

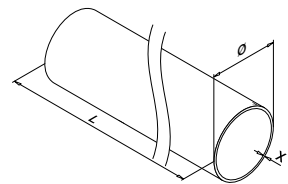

MOD 0900

V4A	316	Gebürstet					
	OUTDOOR	Ø	X				
140900-242-50-12		42,4	2,0			L = 5 m	

PREFIX



Q-INFO MOD 0504

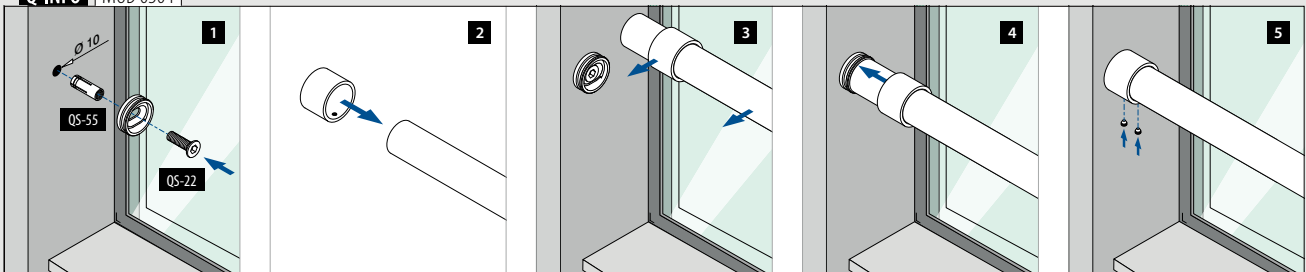

Absturzstangen Ø42,4 - MOD 6517

Fassadenmontage

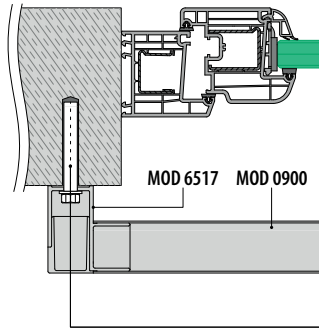

Rahmenmontage

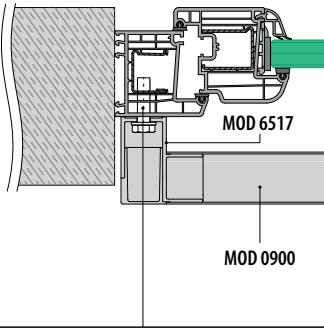

Bitte beachten Sie die Spezifikationen wie zum Beispiel Befestigungsmasse der jeweiligen Zertifikate und statischen Berechnungen.

Anker: ■457 - 463

Handläufe

Wandflansche

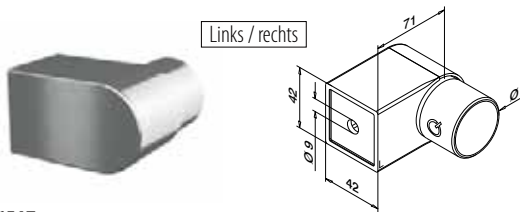

MOD 6517

V4A	316	Gebürstet		
	OUTDOOR	Für Rohr Ø		
146517-242-12		42,4 x 2,0	QS-27 ■472	2

NEW

Handläufe

Rohre

Q-TUBE

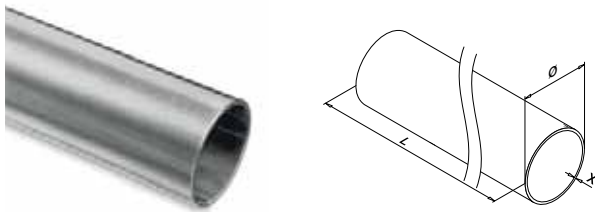

MOD 0900

V4A	316	Gebürstet		
	OUTDOOR	Ø	X	
140900-242-50-12		42,4	2,0	L = 5 m



Q-INFO

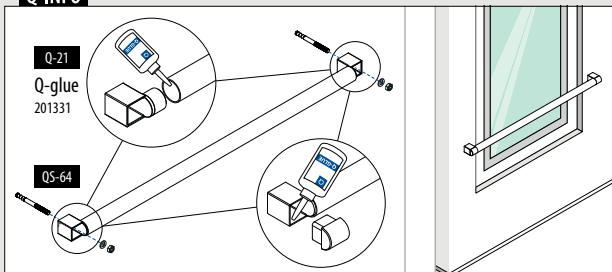

Q-INFO MOD 0900

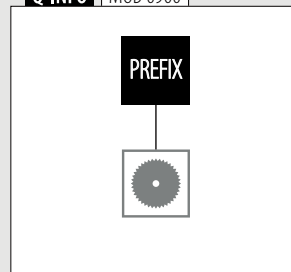



STAB AUSFACHUNG FÜR EASY ALU

Die Stabausfachung (vertikale Stabfüllung) für Easy Alu ist sowohl für Neubauten als auch Renovierungsobjekte ideal. Die Füllungen können Sie zudem in jeder gewünschten RAL-Farbe pulverbeschichten lassen, damit es zum Farbschema des Gebäudes passt. Diese Option für französische Balkone ist auf Anfrage erhältlich.

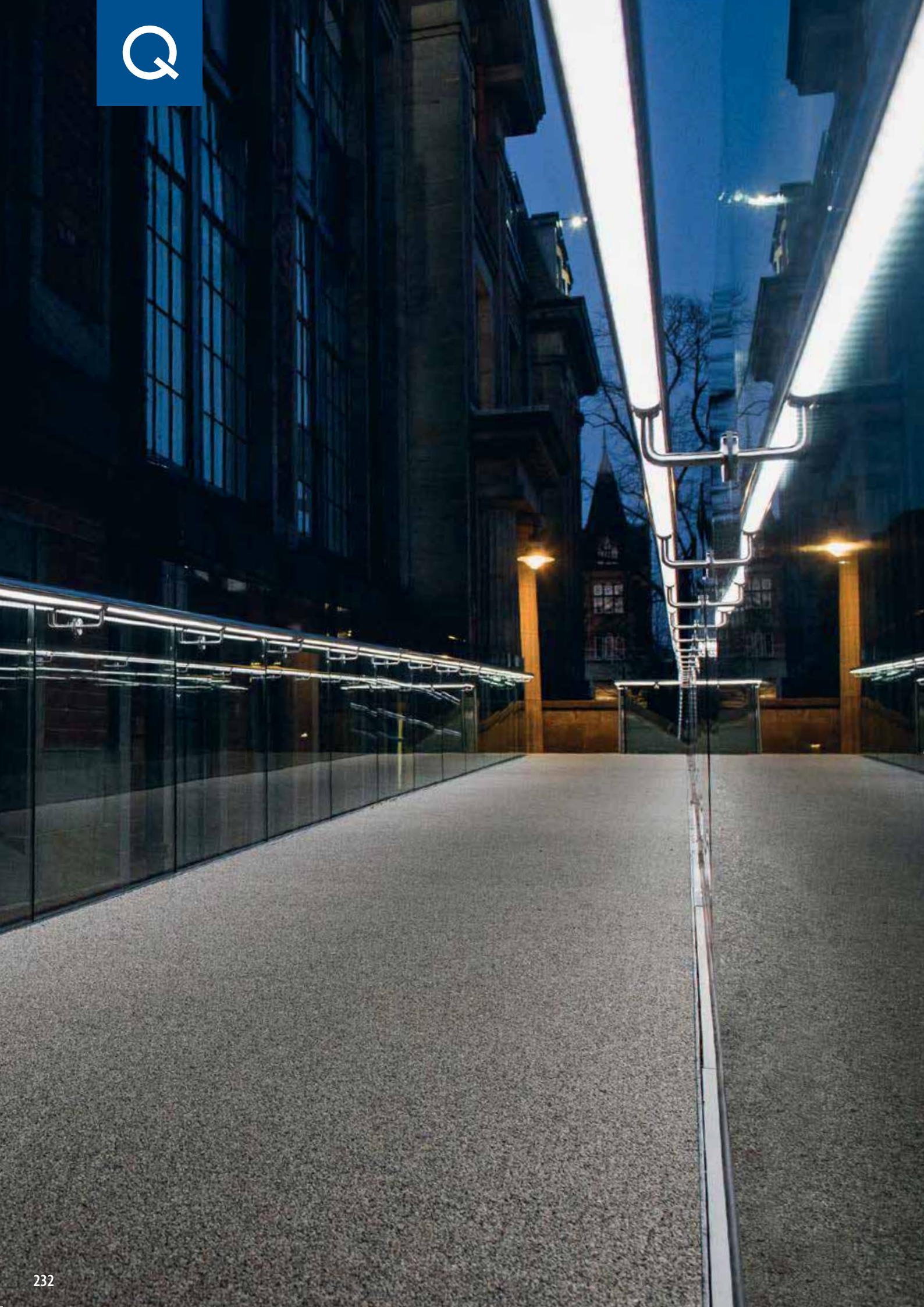

3

Q-LIGHTS SYSTEME

Q-lights Spotlight ————— 236 - 237, 260 - 262, 265
Q-lights Linear Light ————— 238 - 265



Beanspruchung: Leicht bis hoch (IK10 vandalismussicher)

Verwendung: Innen- und Aussenbereich (IP00 - IP66)

Varianten: 24 V und 48 V warm-, neutral- und kaltweisses Licht, RGB-Licht auf Anfrage (Linear Light) und 3000 / 5000K, 12 V (Spotlight)

Anwendung: Ganzglasgeländer, Pfostengeländer, wandmontierte Handläufe

Material: Aluminium, Edelstahl V2A oder V4A

Finden Sie alle Informationen zu Spotlight online:



<https://q-ne.ws/Spotlight23>

Finden Sie alle Informationen zu Linear Light online:



<https://q-ne.ws/LinearLight23>

Q-LIGHTS SYSTEME



Q-lights Spotlight



Q-lights Linear Light

Ambiente und Sicherheit steigern

Wenn Sie ein Geländer mit einer gut designten Beleuchtung versehen, verändern Sie nicht nur das Ambiente, sondern machen es auch sicherer für die Benutzer. Q-lights Spotlight und Q-lights Linear Light stellen Ihnen eine beeindruckende Auswahl von Lichteffekten zur Verfügung. Beide LED-Systeme lassen sich ganz einfach in das von Ihnen gewählte Q-railing Geländer integrieren.

International getestet/berechnet/zertifiziert:

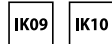

- 1 LED-Bänder: für extrem klare, kraftvolle Lichteffekte.
- 2 LED-Bänder mit bis zu 30 Metern Länge.
- 3 Steigern Sie die Sicherheit, indem Sie Licht zu Ihren Geländern hinzufügen. Mit Q-lights stehen Geländer und Gehwege sowohl im Innen- als auch im Aussenbereich im Fokus.



Q-LIGHTS VARIANTEN

Spotlight für Handläufe

- Für runde Edelstahlrohre (Ø 42,4 oder 48,3 mm)
- Handlaufstützen, Handlaufadapter und Wandflansche mit Kabelkanal
- Kaltweisses Licht (5000K, 12V), warmweisses Licht (3000K, 12V)

236 - 237, 260 - 262, 265

Linear Light für Glasleistenrohre

- LED-Bänder in 5 und 30 Metern Länge
- Bringen Sie die LED-Bänder vor oder hinter dem Glas an
- Transparente oder matte Kunststoffabdeckungen erhältlich
- Warmweisses oder kaltweisses Licht (24V und 48V), RGB-Licht auf Anfrage

238 - 255

Linear Light für Handläufe

- LED-Bänder in 5 und 30 Metern Länge
- Handlaufstützen mit Kabelkanal
- Spezielle Adapter für die Montage auf Handlaufstützen
- Transparente oder matte Kunststoffabdeckungen erhältlich
- Warmweisses oder kaltweisses Licht (24V und 48V), RGB-Licht auf Anfrage

238 - 253, 256 - 265

Für Rohr Ø 42,4 x 2,0 mm

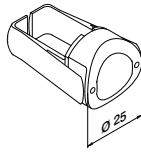
Asymmetrischer Lichtstrahl
Farbtemperatur 3000K + 5000K
50.000 Stunden Licht

MOD 0051

INDOOR	Farbe (K)	Elektr. Spezifikationen	☐
190051-242-20-30	Warmweiss	0,5W, 12V, 40mA, 22lm	1
190051-242-20-50	Kaltweiss	0,5W, 12V, 40mA, 22lm	1

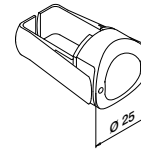

Für Rohr Ø 48,3 x 2,0 mm

Asymmetrischer Lichtstrahl
Farbtemperatur 3000K + 5000K
50.000 Stunden Licht

MOD 0051

INDOOR	Farbe (K)	Elektr. Spezifikationen	☐
190051-248-20-30	Warmweiss	0,5W, 12V, 40mA, 22lm	1
190051-248-20-50	Kaltweiss	0,5W, 12V, 40mA, 22lm	1

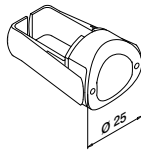

Für Rohr Ø 42,4 x 2,0 mm

Asymmetrischer Lichtstrahl
Farbtemperatur 3000K + 5000K
50.000 Stunden Licht

MOD 0051

OUTDOOR	Farbe (K)	Elektr. Spezifikationen	☐
190051-242-66-30	Warmweiss	0,55W, 12V, 45mA, 25lm	1
190051-242-66-50	Kaltweiss	0,55W, 12V, 45mA, 25lm	1

Internationaler
Geschmacksmusterschutz

Für Rohr Ø 48,3 x 2,0 mm

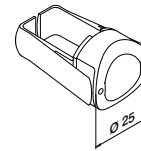
Asymmetrischer Lichtstrahl
Farbtemperatur 3000K + 5000K
50.000 Stunden Licht

MOD 0051

OUTDOOR	Farbe (K)	Elektr. Spezifikationen	☐
190051-248-66-30	Warmweiss	0,55W, 12V, 45mA, 25lm	1
190051-248-66-50	Kaltweiss	0,55W, 12V, 45mA, 25lm	1

Internationaler
Geschmacksmusterschutz

Q-INFO

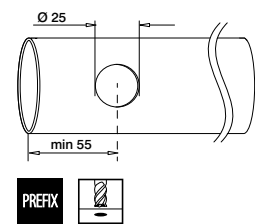

Wir empfehlen, das Loch zu fräsen. Wenn dies nicht möglich ist, sollte ein Stufenbohrer benutzt werden. Entgraten Sie jede Bohrung und entfernen Sie alle Rückstände (Innen- und Aussenseite), um eine Beschädigung der Kabel zu verhindern. Erst danach mit der Installation des LED-Systems beginnen.

MOD 0900
☐351MOD 0900
☐367

Q-INFO

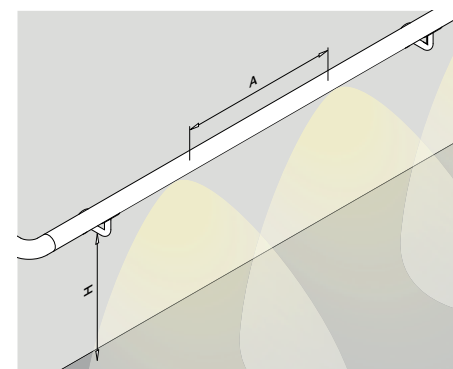

Lichtausbeute am Boden/auf den Treppenstufen bei einem 900 mm hohen Geländer

Höhe (mm) des Fertigfußboden: 900mm

Distanz von der Wand (mm)	0	Abstand (A) zwischen den einzelnen LED-Spotlights (mm)					
		400		600		1000	
		IP20	IP66	IP20	IP66	IP20	IP66
0	52 lx	56 lx	35 lx	37 lx	20 lx	22 lx	
600	32 lx	35 lx	22 lx	24 lx	13 lx	14 lx	

Für die bestmögliche Lichtausbeute empfehlen wir 600 mm Abstand zwischen den einzelnen LED Spotlights.

Alle Angaben zur Lichtkalkulation sind ein Richtwert, da stets die vor Ort gegebenen räumlichen Anforderungen und gesetzlichen Rahmenbedingungen berücksichtigt werden müssen. Wir empfehlen, dass Sie einen Lichtarchitekten oder Elektroingenieur konsultieren, um die genauen Anforderungen für Ihr Projekt zu bestimmen.

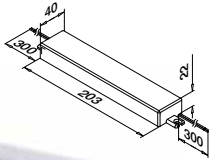

Transformator 12V
220...240V~, CE, ohne Stecker

**MOD 0013**

IN/OUTDOOR	P	
200013-030-66	30W	1

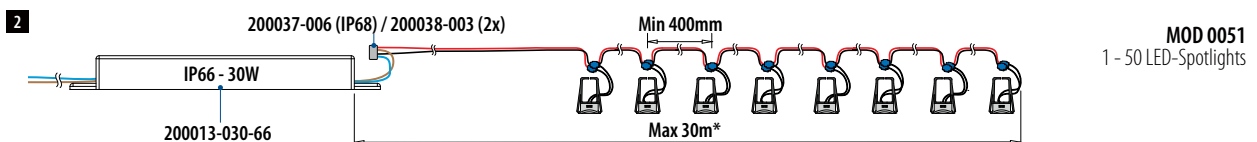
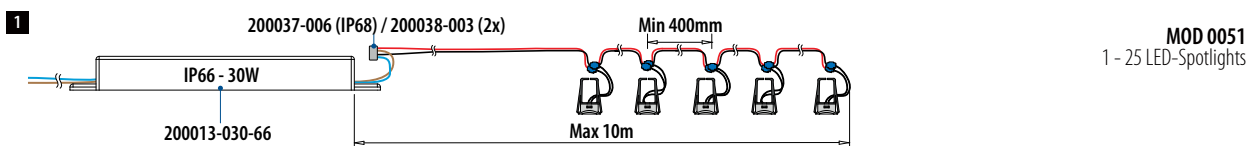
**Q-INFO****Indoor / outdoor**

* EMI/EMC-Konformität beachten

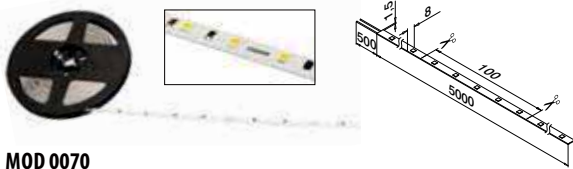
**MOD 0070**

INDOOR	Farbe (K)	LED/m	W	Φ (lm/m)	☐
190070-050-27	Warmweiss	70	14	350	L = 5 m
190070-050-65	Kaltweiss	70	14	370	L = 5 m

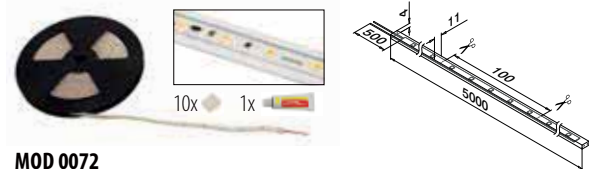
**MOD 0072**

OUTDOOR	Farbe (K)	LED/m	W	Φ (lm/m)	☐
190072-050-30	Warmweiss	70	14	350	L = 5 m
190072-050-65	Kaltweiss	70	14	360	L = 5 m

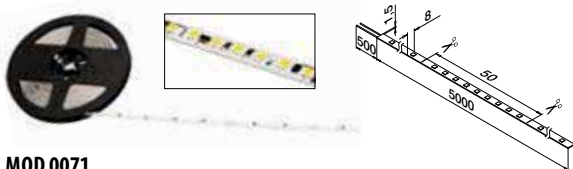
**MOD 0071**

INDOOR	Farbe (K)	LED/m	W	Φ (lm/m)	☐
190071-050-27	Warmweiss	140	27,5	660	L = 5 m
190071-050-65	Kaltweiss	140	27,5	680	L = 5 m

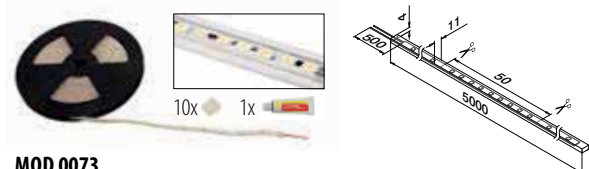
**MOD 0073**

OUTDOOR	Farbe (K)	LED/m	W	Φ (lm/m)	☐
190073-050-30	Warmweiss	140	27,5	640	L = 5 m
190073-050-65	Kaltweiss	140	27,5	650	L = 5 m

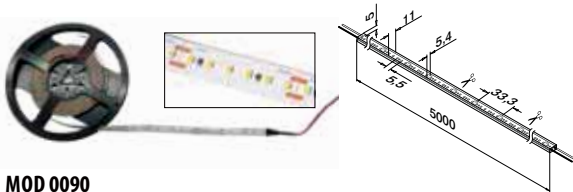
**MOD 0090**

INDOOR	Farbe (K)	LED/m	W	Φ (lm/m)	☐
190090-050-40	Neutralweiss	180	30	650	L = 5 m

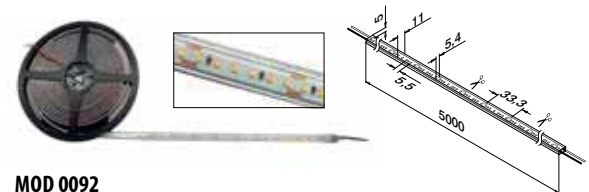
**MOD 0092**

OUTDOOR	Farbe (K)	LED/m	W	Φ (lm/m)	☐
190092-050-40	Neutralweiss	180	30	650	L = 5 m

**Q-INFO**

MOD 0070 / 0072: 70 LED/m
MOD 0071 / 0073: 140 LED/m
MOD 0090 / 0092: 180 LED/m

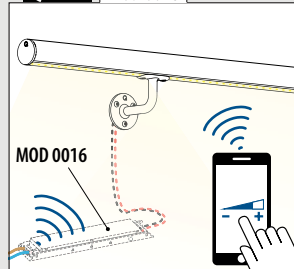
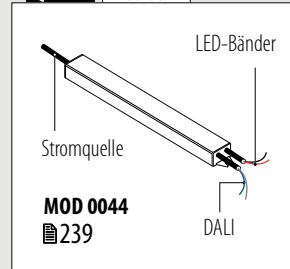
Q-INFO MOD 0016**Q-INFO** MOD 0044**Q-INFO**

INFORMATIONEN ZU DEN LED-BÄNDERN

- Alle LED-Bänder sind vorverkabelt an einem Ende. Für weitere Verbindungen, verwenden Sie ein Anschlusskabel (■ 240-242).
- Alle LED-Bänder können mit einer Schere (zwischen den Kupferpunkten) auf die gewünschte Länge zugeschnitten werden
- LED-Bänder können zugeschnitten und mittels Steckern verbunden werden (■ 240-242).
- Alle Modelle sind für Verbinder bei Linear Light Glasleistenrohre (■ 254-255) und Linear Light Handläufen geeignet (■ 256-265).

Transformator 24V
für Q-lights Linear Light IP20
220...240V~



MOD 0015

INDOOR	P	
200015-100-20	100W	1



Transformator 24V
für Q-lights Linear Light IP67
220...240V~

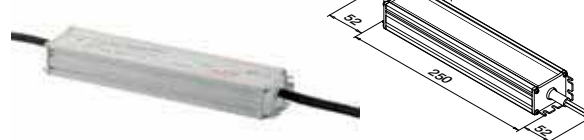

MOD 0015

OUTDOOR	P	
200015-100-67	100W	1



Transformator mit Bluetooth-Steuerung 24V
für Q-lights Linear Light IP20
220...240V~



MOD 0016

INDOOR	P	
200016-080	80W	1



Transformator 24V mit DALI
für Q-lights Linear Light IP67
220...240V~ CE

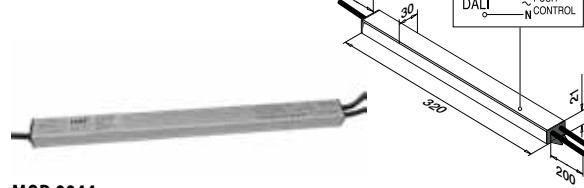

MOD 0044

OUTDOOR	P	
200044-100-67	100W	1



Q-INFO | MOD 007x / 009x

Übersicht Q-lights Linear Light LED-Bänder

LED-Bänder	IP	V	W	W/m	K	Colour	lm	lm/m		LED/m	L (mm)	L _{mm} (mm)			50.000 h	CRI	
190070-050-27	00	24	14	2,8	2700	warmweiss	1750	350	120	70	5000	100	✓		50.000 h	>80	20
190070-050-65	00	24	14	2,8	6500	kaltweiss	1850	370	120	70	5000	100	✓		50.000 h	>80	20
190072-050-30	66	24	14	2,8	3000	warmweiss	1750	350	120	70	5000	100	✓		50.000 h	>80	20
190072-050-65	66	24	14	2,8	6500	kaltweiss	1800	360	120	70	5000	100	✓		50.000 h	>80	20
190071-050-27	00	24	27,5	5,5	2700	warmweiss	3100	620	120	140	5000	50	✓		50.000 h	>80	50
190071-050-65	00	24	27,5	5,5	6500	kaltweiss	3400	680	120	140	5000	50	✓		50.000 h	>80	50
190073-050-30	66	24	27,5	5,5	3000	warmweiss	3200	640	120	140	5000	50	✓		50.000 h	>80	50
190073-050-65	66	24	27,5	5,5	6500	kaltweiss	3250	650	120	140	5000	50	✓		50.000 h	>80	50
190090-050-40	20	24	30	6	4000	neutralweiss	3250	650	120	180	5000	33,33	✓		50.000 h	94	50
190092-050-40	54	24	30	6	4000	neutralweiss	3250	650	120	180	5000	33,33	✓		50.000 h	94	50

IP...	IP Schutzart	W/m	Nennleistung pro Meter	lm	Lichtstrom	LED/m	Anzahl LEDs pro Meter
V	Nennspannung	K	Farbtemperatur	lm/m	Lichtstrom pro Meter		Dimmbar
W	Nennleistung	Colour	Lichtfarbe		Ausstrahlungswinkel		Lebensdauer

Q-INFO | MOD 007x

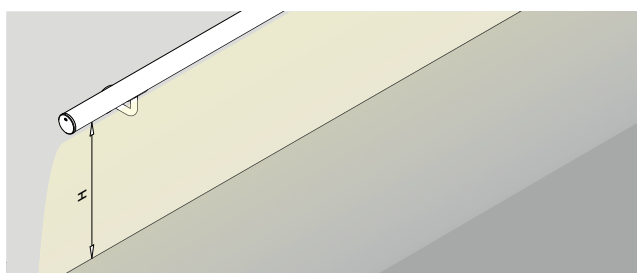

Lux (lx) Erläuterung

Direktes Sonnenlicht	= 100.000 lx	Flurbeleuchtung	= 100 lx
Tageslicht bei Bewölkung,	= 1.000 lx	Strassenbeleuchtung	= 10 lx
typisches Studioliicht		Kerzenlicht aus 1 m Entfernung	= 1 lx

Lichtausbeute am Boden/auf den Treppenstufen

	Höhe (mm) des Fertigfußboden			
	900	1000	1100	1200
190070-050-27	125 lx	106 lx	90 lx	78 lx
190070-050-65	144 lx	113 lx	94 lx	82 lx
190072-050-30	106 lx	90 lx	75 lx	66 lx
190072-050-65	111 lx	94 lx	78 lx	69 lx
190071-050-27	203 lx	172 lx	144 lx	121 lx
190071-050-65	223 lx	198 lx	151 lx	131 lx
190073-050-30	203 lx	172 lx	120 lx	92 lx
190073-050-65	217 lx	184 lx	130 lx	100 lx
190090-050-40	163 lx	139 lx	120 lx	104 lx
190092-050-40	163 lx	139 lx	120 lx	104 lx

Alle Angaben zur Lichtkalkulation sind ein Richtwert, da stets die vor Ort gegebenen räumlichen Anforderungen und gesetzlichen Rahmenbedingungen berücksichtigt werden müssen. Wir empfehlen, dass Sie einen Lichtarchitekten oder Elektroingenieur konsultieren, um die genauen Anforderungen für Ihr Projekt zu bestimmen.

Universalverbinder, Streifen zu Streifen



MOD 0046

INDOOR	Für MOD	V	
200046-008	0070, 0071	24 / 48	1
200046-010	0080, 0090	24 / 48	1

NEW IP20

Universal-Eckverbinder

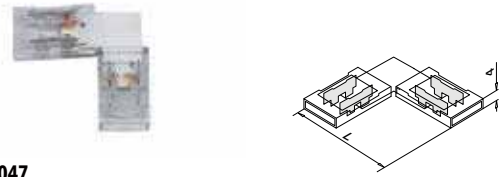

MOD 0047

INDOOR	Für MOD	V	L	
200047-008	0070, 0071	24 / 48	25	1
200047-010	0080, 0090	24 / 48	30	1

NEW IP20

Universal-Flex-Verbinder

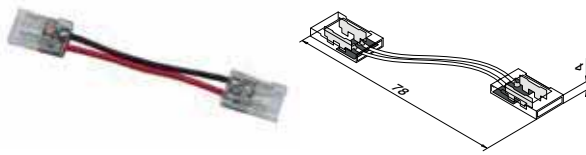

MOD 0048

INDOOR	Für MOD	V	
200048-008	0070, 0071	24 / 48	1
200048-010	0080, 0090	24 / 48	1

NEW IP20

Universal-Anschlusskabel

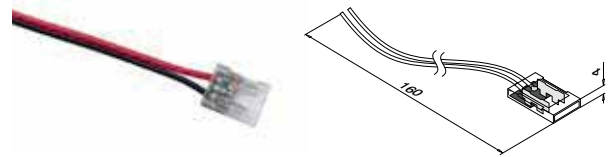

MOD 0049

INDOOR	Für MOD	V	
200049-008	0070, 0071	24 / 48	1
200049-010	0080, 0090	24 / 48	1

NEW IP20

Q-INFO MOD 0046

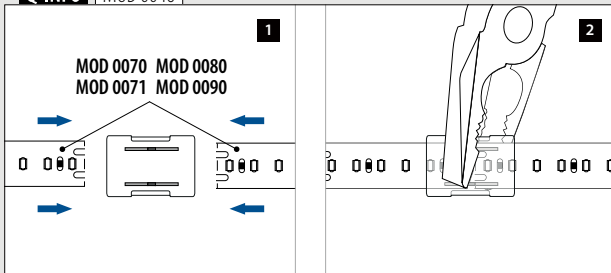

Q-INFO MOD 0047

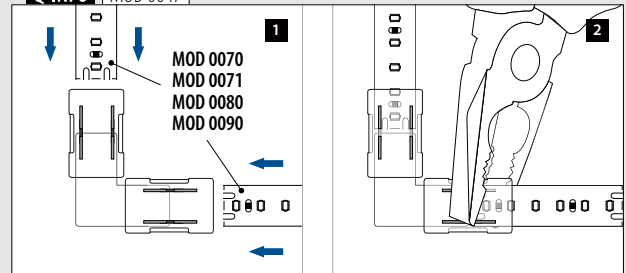

Q-INFO MOD 0048

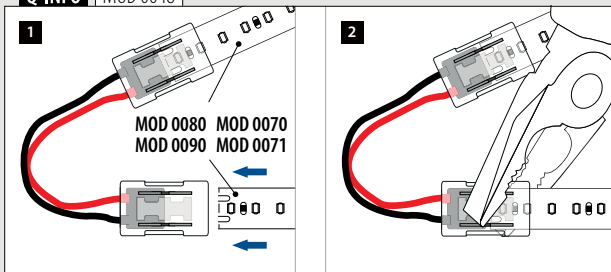

Q-INFO MOD 0049

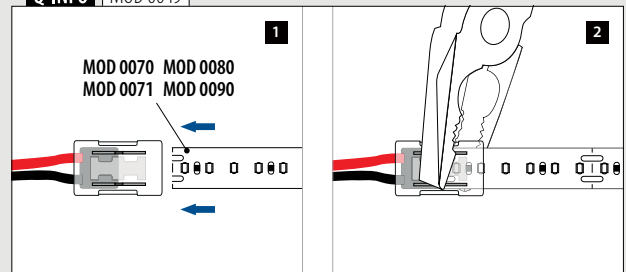

Universalverbinder, Streifen zu Streifen

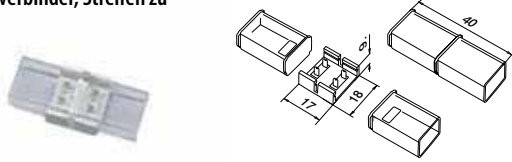

MOD 0053

OUTDOOR	Für MOD	V	
200053	0072, 0073, 0082, 0092	24 / 48	1



Universal-Flex-Verbinder

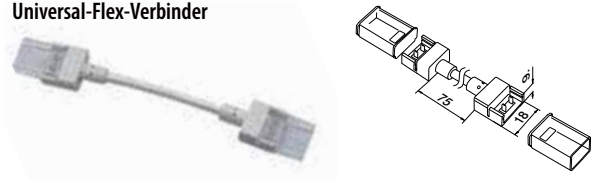

MOD 0054

OUTDOOR	Für MOD	V	
200054	0072, 0073, 0082, 0092	24 / 48	1



Universal-Anschlusskabel

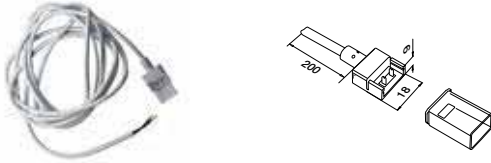

MOD 0055

OUTDOOR	Für MOD	V	
200055	0072, 0073, 0082, 0092	24 / 48	1



Silikon + Endkappen

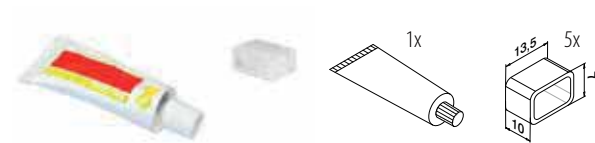

MOD 0039

OUTDOOR		
200039	1	

Q-LIGHTS SYSTEME

Q-LIGHTS - VERBINDUNGSTECHNIK

Q-INFO | MOD 0053 / 0054 / 0055

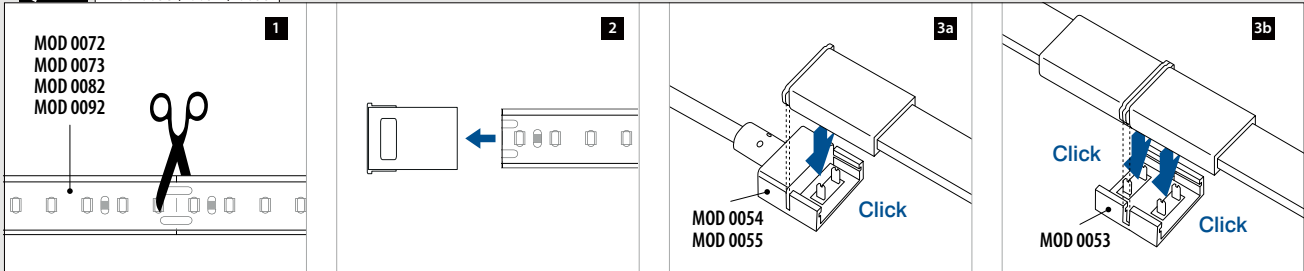

Q-INFO | MOD 0039

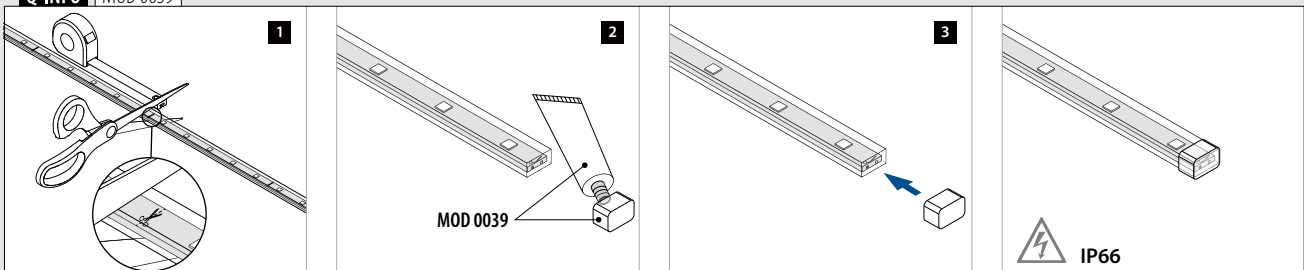

Anschlusskabel für LED-Bänder
für MOD 0070 / 0071

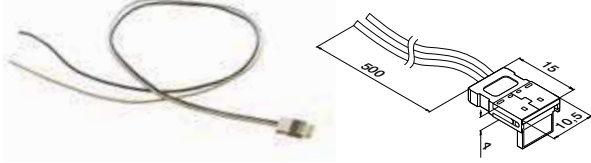

MOD 0020	INDOOR	V	L	
200020-20		24	500	1
IP20				

Anschlusskabel für LED-Bänder
für MOD 0072 / 0073

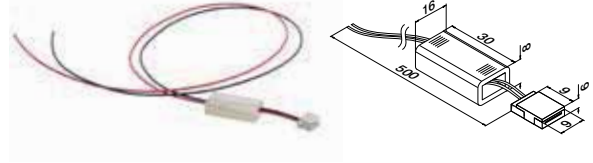

MOD 0020	OUTDOOR	V	L	
200020-54		24V	500	1
IP54				

Verbinder für LED-Bänder



MOD 0018	INDOOR		
200018			1
IP20			

Verbindungskabel für LED-Bänder



MOD 0019	INDOOR		
200019			1
IP20			

Hülse für LED-Band Verbinder
für LED-Bänder MOD 0072 / 0073



MOD 0023	OUTDOOR		
200023			1
IP54			

SELL OUT Nur solange der Vorrat reicht.

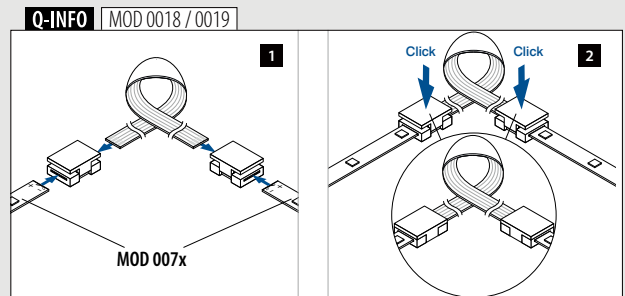
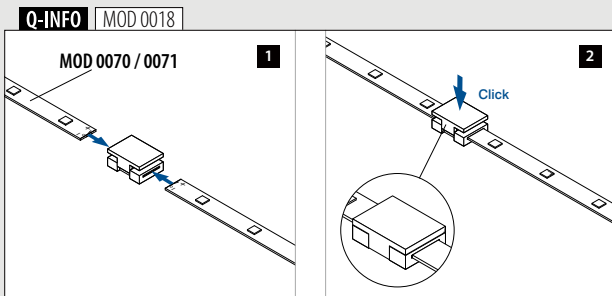
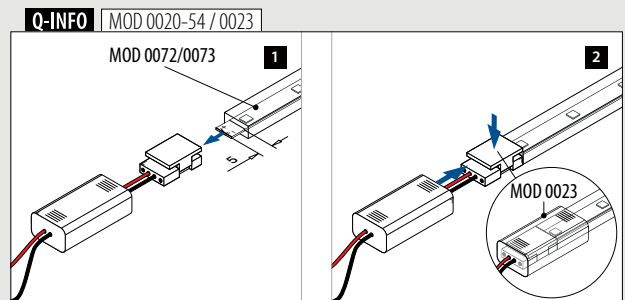
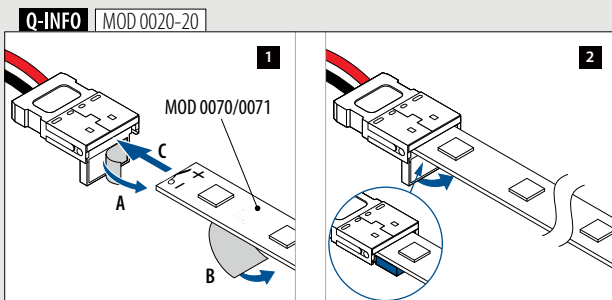

Q-INFO | MOD 0070/0071

Indoor

1

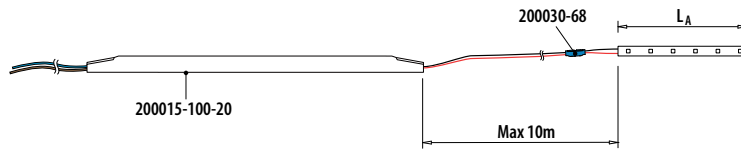

MOD 0070/0071
 $L_A \leq 5,00 \text{ m}$

2

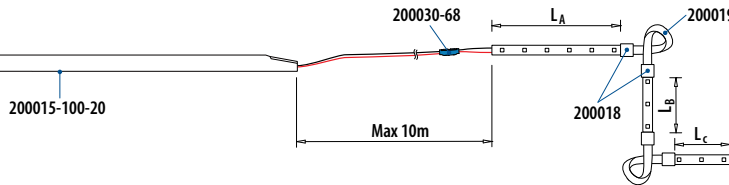

MOD 0070/0071
 $L_A + L_B + L_C \leq 5,00 \text{ m}$

3A

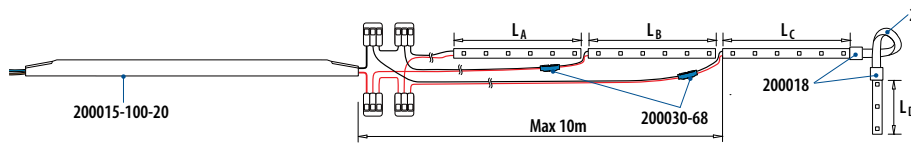

MOD 0070/0071
 $L_A \leq 5,00 \text{ m}$
 $L_B \leq 5,00 \text{ m}$
 $L_C + L_D \leq 5,00 \text{ m}$
 MOD 0070: $L_A + L_B + L_C + L_D \leq 20,00 \text{ m}$
 MOD 0071: $L_A + L_B + L_C + L_D \leq 15,00 \text{ m}$

3B

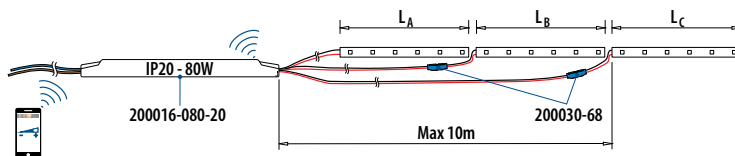

MOD 0070/0071
 $L_A + L_B \leq 5,00 \text{ m}$
 $L_C \leq 5,00 \text{ m}$
 $L_D \leq 5,00 \text{ m}$
 MOD 0070: $L_A + L_B + L_C + L_D \leq 15,00 \text{ m}$
 MOD 0071: $L_A + L_B + L_C + L_D \leq 13,50 \text{ m}$

Q-INFO | MOD 0072/0073

Outdoor

4

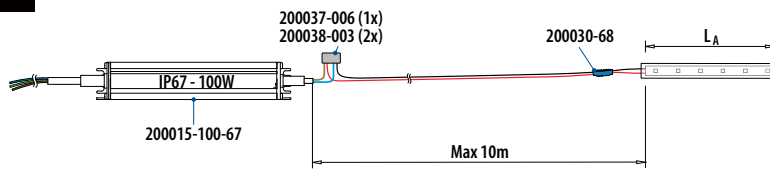

MOD 0072/0073
 $L_A + L_B + L_C \leq 5,00 \text{ m}$

5

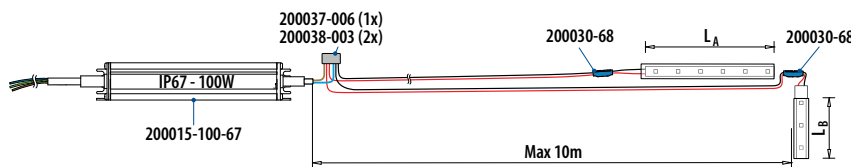

MOD 0072/0073
 $L_A \leq 5,00 \text{ m}$
 $L_B \leq 5,00 \text{ m}$
 $L_C + L_D \leq 5,00 \text{ m}$
 $L_A + L_B + L_C + L_D \leq 15,00 \text{ m}$

6

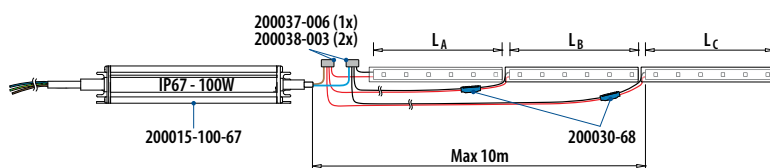

MOD 0072/0073
 $L_A \leq 5,00 \text{ m}$
 $L_B \leq 5,00 \text{ m}$
 $L_C + L_D \leq 5,00 \text{ m}$
 $L_A + L_B + L_C + L_D \leq 15,00 \text{ m}$

Q-INFO | MOD 0090

Indoor

1

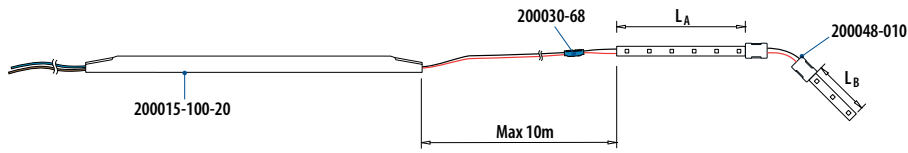

MOD 0090
 $L_A \leq 5,00 \text{ m}$
 $L_B \leq 5,00 \text{ m}$
 $L_A + L_B \leq 10,00 \text{ m}$

2

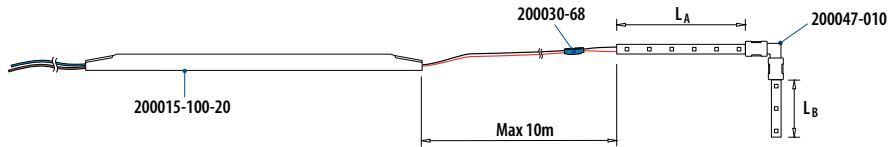

MOD 0090
 $L_A \leq 5,00 \text{ m}$
 $L_B \leq 5,00 \text{ m}$
 $L_A + L_B \leq 10,00 \text{ m}$

3

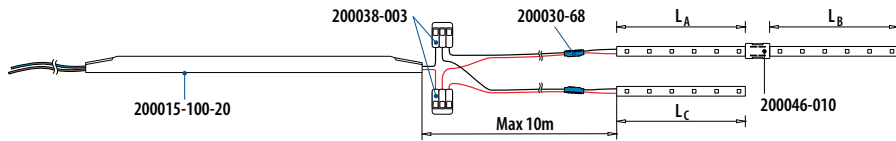

MOD 0090
 $L_A \leq 5,00 \text{ m}$
 $L_B \leq 5,00 \text{ m}$
 $L_A + L_B \leq 10,00 \text{ m}$
 $L_A + L_B + L_C \leq 15,00 \text{ m}$

Q-INFO | MOD 0092

Outdoor

4

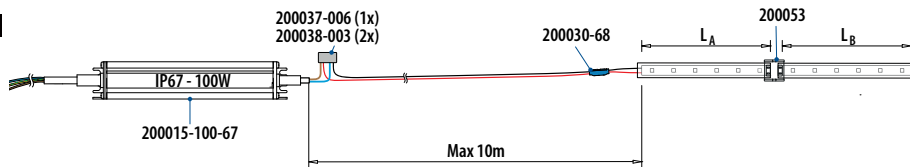

MOD 0092
 $L_A + L_B \leq 10,00 \text{ m}$

5

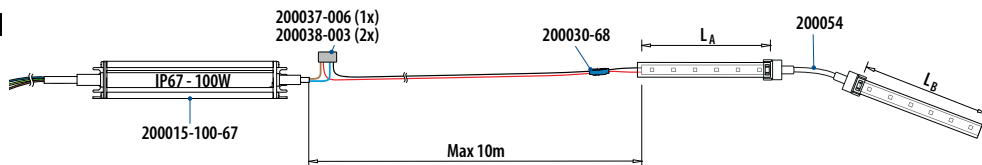

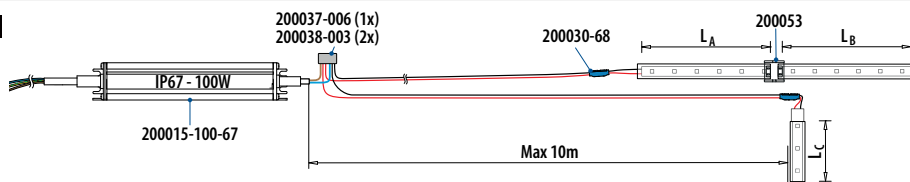

MOD 0092
 $L_A + L_B \leq 10,00 \text{ m}$

6

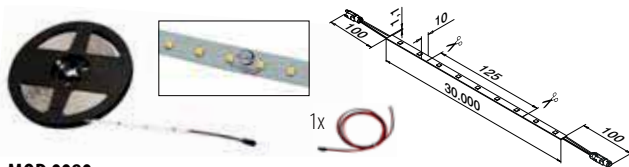

MOD 0092
 $L_A \leq 5,00 \text{ m}$
 $L_B \leq 5,00 \text{ m}$
 $L_A + L_B \leq 10,00 \text{ m}$
 $L_A + L_B + L_C \leq 15,00 \text{ m}$

**MOD 0080**

INDOOR	Farbe (K)	LED/m	W	Φ (lm/m)	
190080-300-30	Warmweiss	84	117	424	L = 30 m
190080-300-65	Kaltweiss	84	117	437	L = 30 m

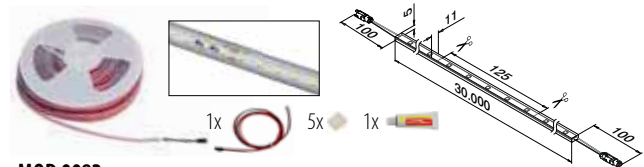
**MOD 0082**

OUTDOOR	Farbe (K)	LED/m	W	Φ (lm/m)	
190082-300-30	Warmweiss	84	117	390	L = 30 m
190082-300-65	Kaltweiss	84	117	402	L = 30 m

**Q-INFO**

INFORMATIONEN ZU DEN LED-BÄNDERN

- Alle LED-Bänder sind vorverkabelt an einem Ende. Für weitere Verbindungen, verwenden Sie ein Anschlusskabel (■ 247-250).
- Alle LED-Bänder können mit einer Schere (zwischen den Kupferpunkten) auf die gewünschte Länge zugeschnitten werden.
- LED-Bänder können zugeschnitten und mittels Steckern verbunden werden (■ 247-250).
- Alle Modelle sind für Verbinder bei Linear Light Glasleistenrohre (■ 254-255) und Linear Light Handläufen geeignet (■ 256-265).

Transformator 48V
für Q-lights Linear Light IP67
220...240V~, CE

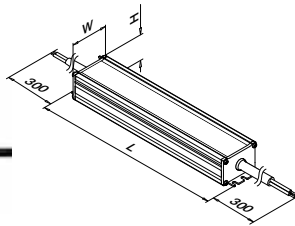

MOD 0017

OUTDOOR	P	L	W	H	
200017-060-67	60 W	116	67,5	36,5	1
200017-150-67	150 W	166	67,5	40	1
200017-350-67	350 W	227	80	42	1



Transformator 48V
für Q-lights Linear Light IP67
220...240V~, CE

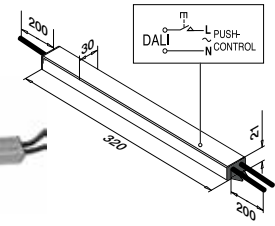

MOD 0045

OUTDOOR	W	
200045-240-67	240	1



Transformator 48V
für Q-lights Linear Light IP67
220...240V~, CE

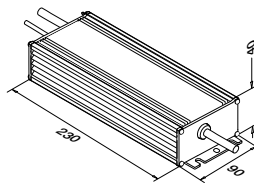

MOD 0045

OUTDOOR	W	
200045-400-67	400	1



Q-INFO | MOD 0045

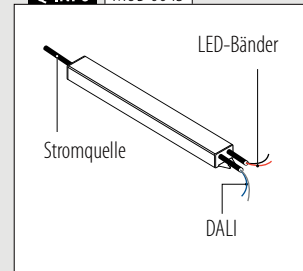

Q-INFO | MOD 008x

Übersicht Q-lights Linear Light LED-Bänder

LED-Bänder	IP	V	W	W/m	K	Colour	lm	lm/m		LED/m	L (mm)	L _{min} (mm)			CRI ...	
190080-300-30	20	48	117	3,9	3000	warmweiss	12.720	424	120	84	30.000	125	✓		50.000 h >80	30
190080-300-65	20	48	117	3,9	6500	kaltweiss	13.110	437	120	84	30.000	125	✓		50.000 h >80	30
190082-300-30	66	48	117	3,9	3000	warmweiss	11.700	390	120	84	30.000	125	✓		50.000 h >80	30
190082-300-65	66	48	117	3,9	6500	kaltweiss	12.060	402	120	84	30.000	125	✓		50.000 h >80	30

IP... IP Schutzart	W/m Nennleistung pro Meter	lm Lichtstrom	LED/m Anzahl LEDs pro Meter
V Nennspannung	K Farbtemperatur	lm/m Lichtstrom pro Meter	Dimmbar
W Nennleistung	Colour Lichtfarbe	Ausstrahlungswinkel	Lebensdauer

Q-INFO | MOD 008x

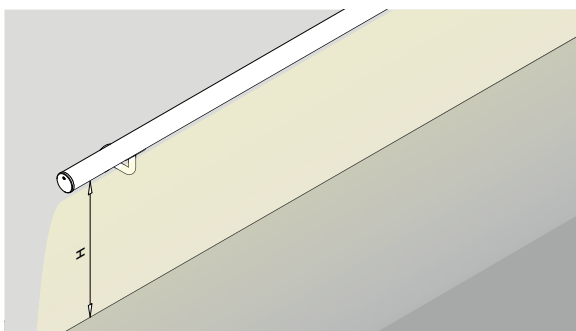

Lichtausbeute am Boden/auf den Treppenstufen

	Höhe (mm) des Fertigfußboden			
	900	1000	1100	1200
190080-300-30	165 lx	156 lx	146 lx	135 lx
190080-300-65	173 lx	163 lx	152 lx	141 lx
190082-300-30	154 lx	145 lx	136 lx	124 lx
190082-300-65	160 lx	150 lx	140 lx	128 lx

Lux (lx) Erläuterung

Direktes Sonnenlicht	= 100.000 lx	Flurbeleuchtung	= 100 lx
Tageslicht bei Bewölkung,	= 1.000 lx	Strassenbeleuchtung	= 10 lx
typisches Studiolicht		Kerzenlicht aus 1 m Entfernung	= 1 lx

Alle Angaben zur Lichtkalkulation sind ein Richtwert, da stets die vor Ort gegebenen räumlichen Anforderungen und gesetzlichen Rahmenbedingungen berücksichtigt werden müssen. Wir empfehlen, dass Sie einen Lichtarchitekten oder Elektroingenieur konsultieren, um die genauen Anforderungen für Ihr Projekt zu bestimmen.

Anschlusskabel für LED-Bänder, weiblich

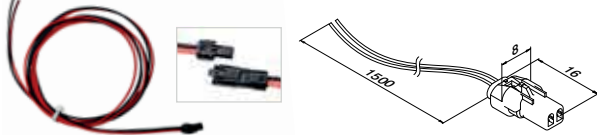

MOD 0032				
OUTDOOR	V	L		
200032-015-68	48	1500		1

IP68

Silikon + Endkappen

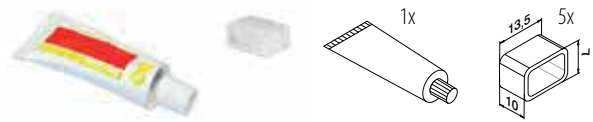

MOD 0039				
OUTDOOR				
200039				1

Verbinder für LED-Bänder

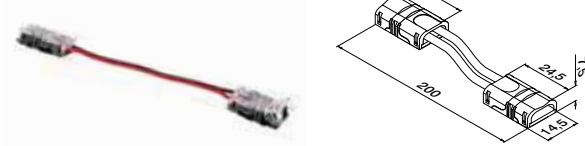

MOD 0028				
INDOOR				
200028				1

IP20

Verbinder für LED-Bänder

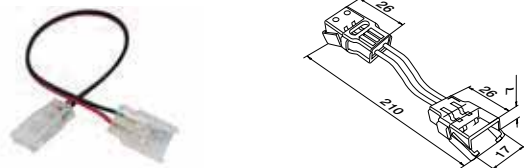

MOD 0031				
OUTDOOR				
200031				1

IP66

Q-INFO MOD 0032

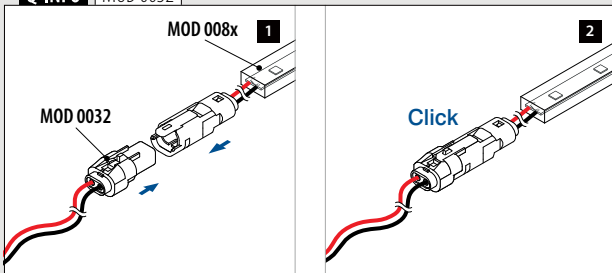

Q-INFO

INFORMATIONEN ZU DEN LED-BÄNDERN

- Alle LED-Bänder werden als Set geliefert, inklusive 1x MOD 0032 und 1x MOD 0039.
- Verwenden Sie für weitere Verbindungen den Kabelverbinder (MOD 0035, ■ 248) und die Verbindungskabel.

Q-INFO MOD 0028

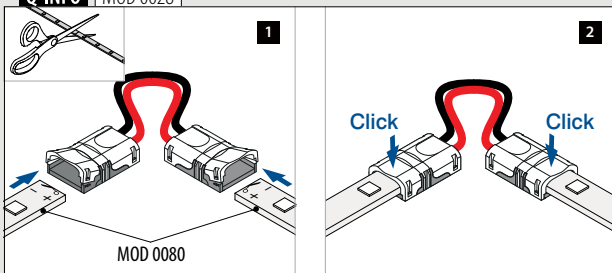

Q-INFO MOD 0031

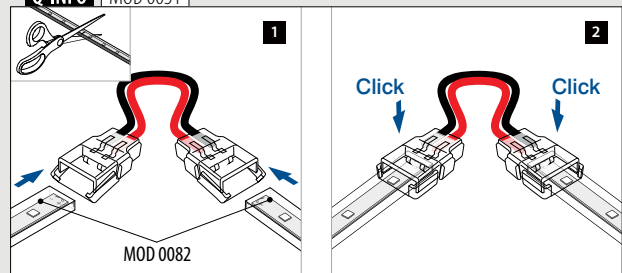

Q-INFO MOD 0039

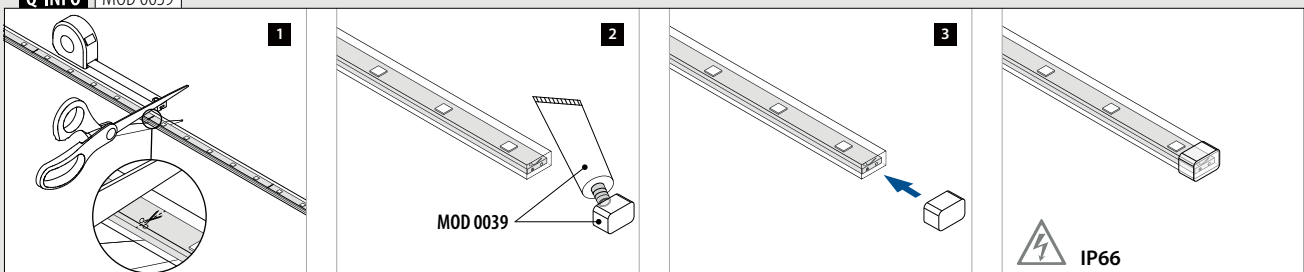

Kabelverbinder, männlich-männlich

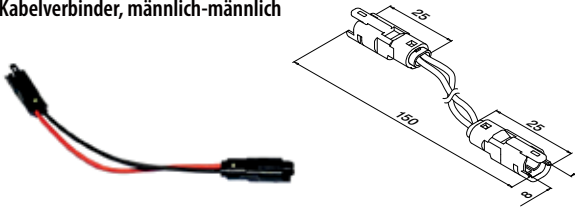

MOD 0035

OUTDOOR



200035

1

IP68

Q-INFO | MOD 0035 / 0032 / 008x

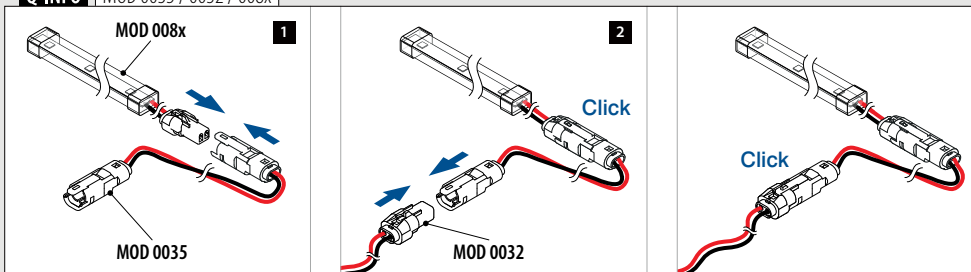

Universalverbinder, Streifen zu Streifen



MOD 0046

INDOOR	Für MOD	V	
200046-008	0070, 0071	24 / 48	1
200046-010	0080, 0090	24 / 48	1

NEW IP20

Universal-Flex-Verbinder

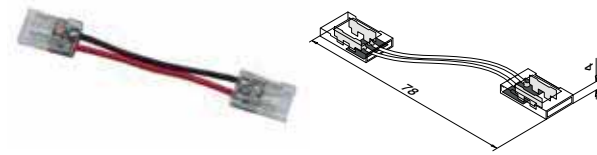

MOD 0048

INDOOR	Für MOD	V	
200048-008	0070, 0071	24 / 48	1
200048-010	0080, 0090	24 / 48	1

NEW IP20

Universal-Eckverbinder

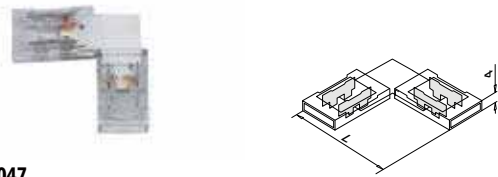

MOD 0047

INDOOR	Für MOD	V	L	
200047-008	0070, 0071	24 / 48	25	1
200047-010	0080, 0090	24 / 48	30	1

NEW IP20

Universal-Anschlusskabel

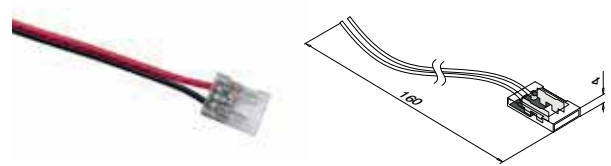

MOD 0049

INDOOR	Für MOD	V	
200049-008	0070, 0071	24 / 48	1
200049-010	0080, 0090	24 / 48	1

NEW IP20

Q-INFO MOD 0046

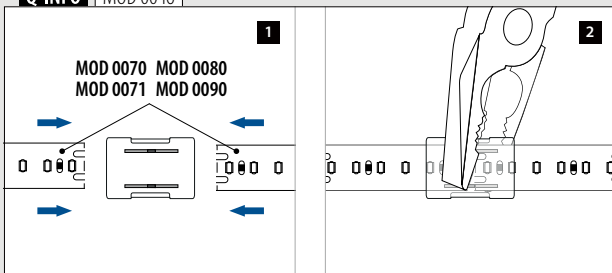

Q-INFO MOD 0047

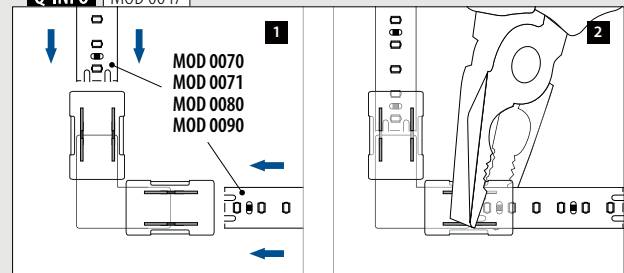

Q-INFO MOD 0048

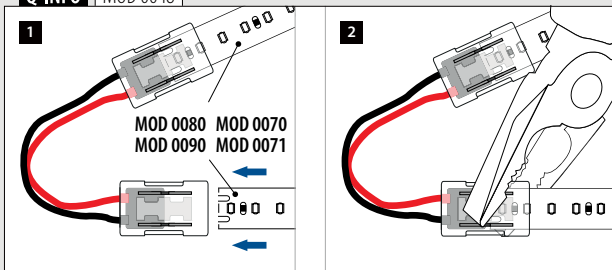

Q-INFO MOD 0049

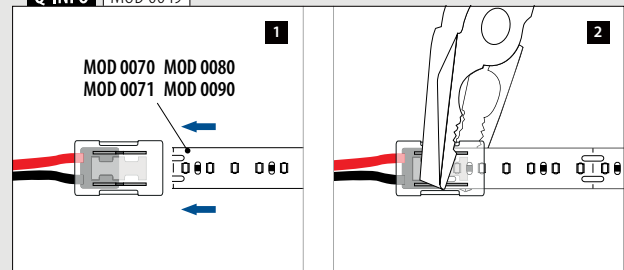

Universalverbinder, Streifen zu Streifen

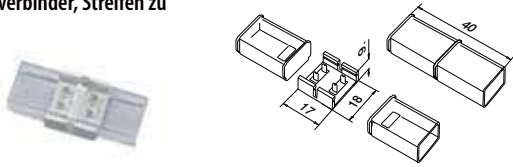

MOD 0053

OUTDOOR	Für MOD	V	
200053	0072, 0073, 0082, 0092	24 / 48	1

NEW IP68

Universal-Flex-Verbinder

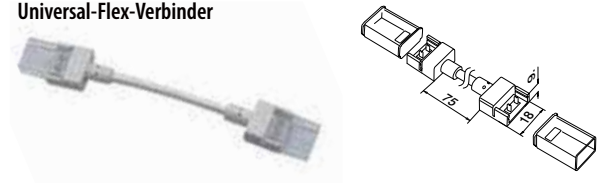

MOD 0054

OUTDOOR	Für MOD	V	
200054	0072, 0073, 0082, 0092	24 / 48	1

NEW IP68

Universal-Anschlusskabel

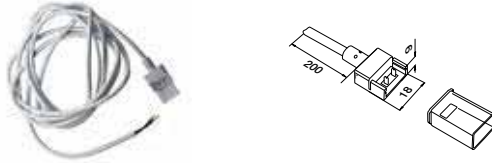

MOD 0055

OUTDOOR	Für MOD	V	
200055	0072, 0073, 0082, 0092	24 / 48	1

NEW IP68

MOD 0053 / 0054 / 0055

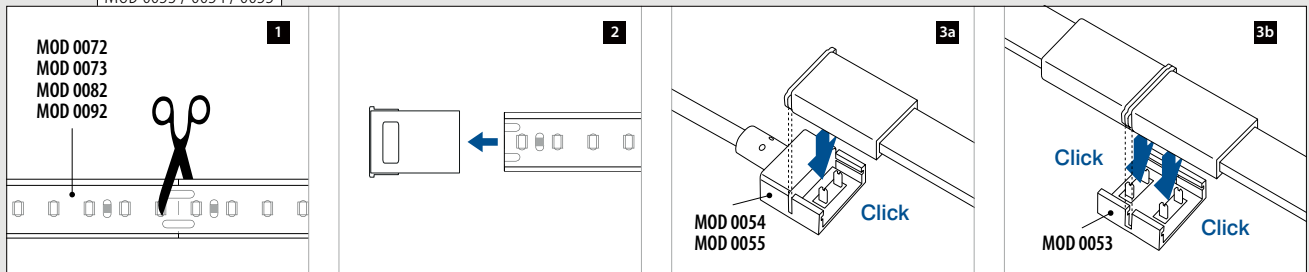

Q-INFO | MOD 008x

Indoor / outdoor

1

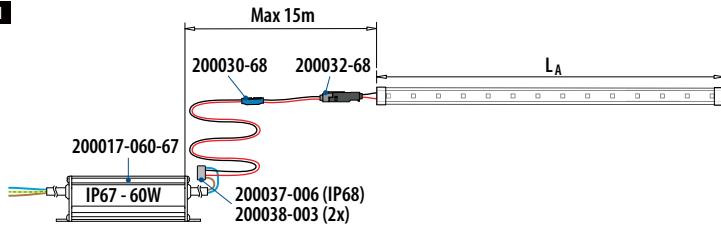

MOD 0080/0082
L_A ≤ 15,00 m

2

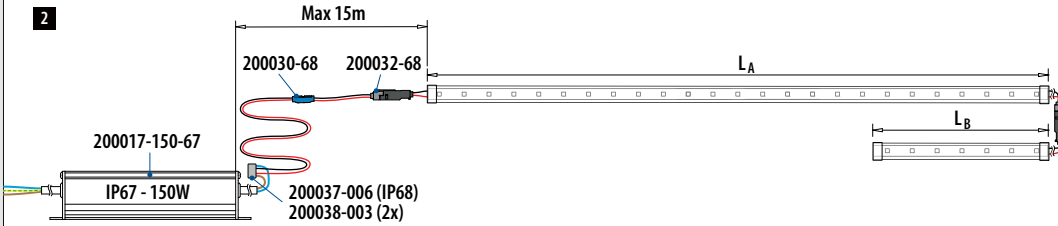

MOD 0080/0082
L_A + L_B ≤ 38,00 m

3

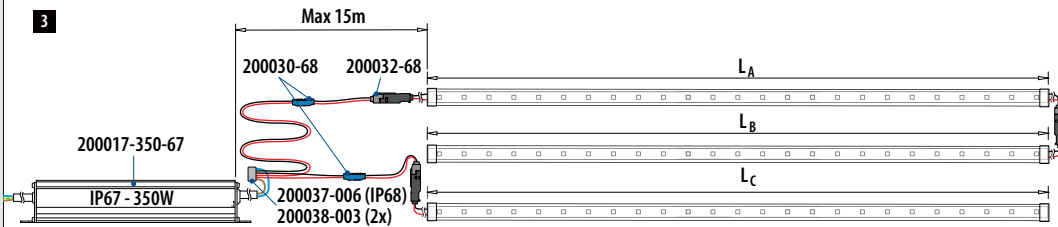

MOD 0080/0082
L_A + L_B ≤ 60,00 m
L_C ≤ 30,00 m
L_A + L_B + L_C ≤ 90,00 m

4

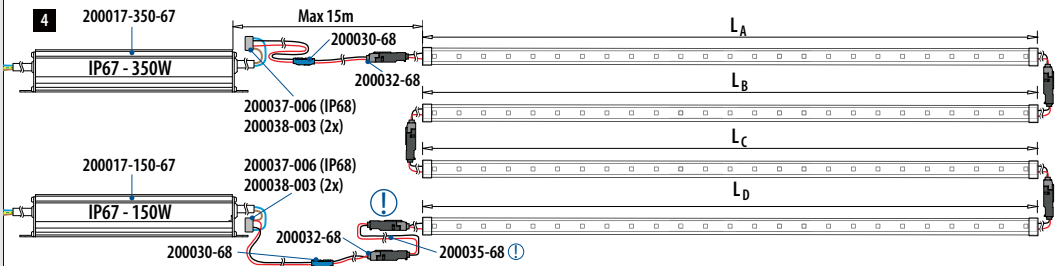

MOD 0080/0082
L_A + L_B + L_C + L_D ≤ 120,00 m

Q-INFO | MOD 008x

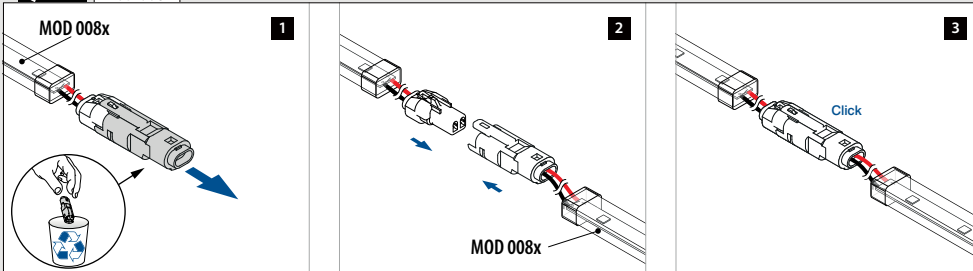

Q-INFO | MOD 0035 / 0032 / 008x

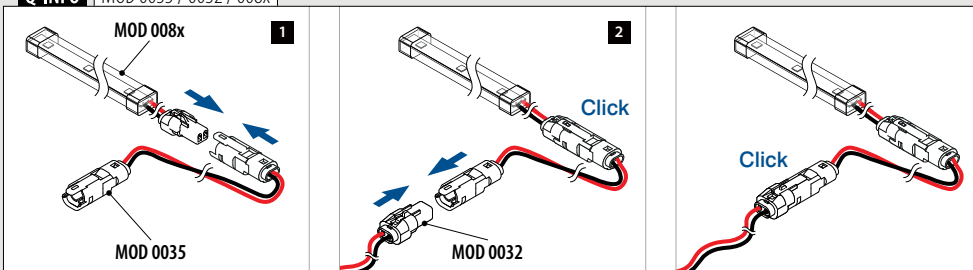

Steuerungsgerät für 12V und 24V

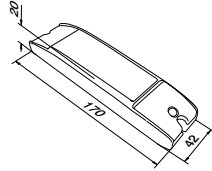

MOD 0040		
INDOOR		
200040		1

NEW

Steuerungsgerät für 24V und 48V

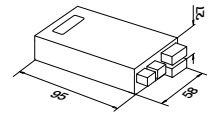

MOD 0041		
INDOOR		
200041		1

NEW

Stromversorgung



Kabel, schwarz

Halogenfrei, 145°C, für 12V, 24V und 48V, für den Aussenbereich geeignet

MOD 0012		
OUTDOOR	\emptyset	
200012-001-01	1 mm ²	L = 100 m
200012-003-01	2,5 mm ²	L = 100 m

NEW



Kabel, rot

Halogenfrei, 145°C, für 12V, 24V und 48V, für den Aussenbereich geeignet

MOD 0012		
OUTDOOR	\emptyset	
200012-001-02	1 mm ²	L = 100 m
200012-003-02	2,5 mm ²	L = 100 m

NEW

Q-INFO | MOD 0040

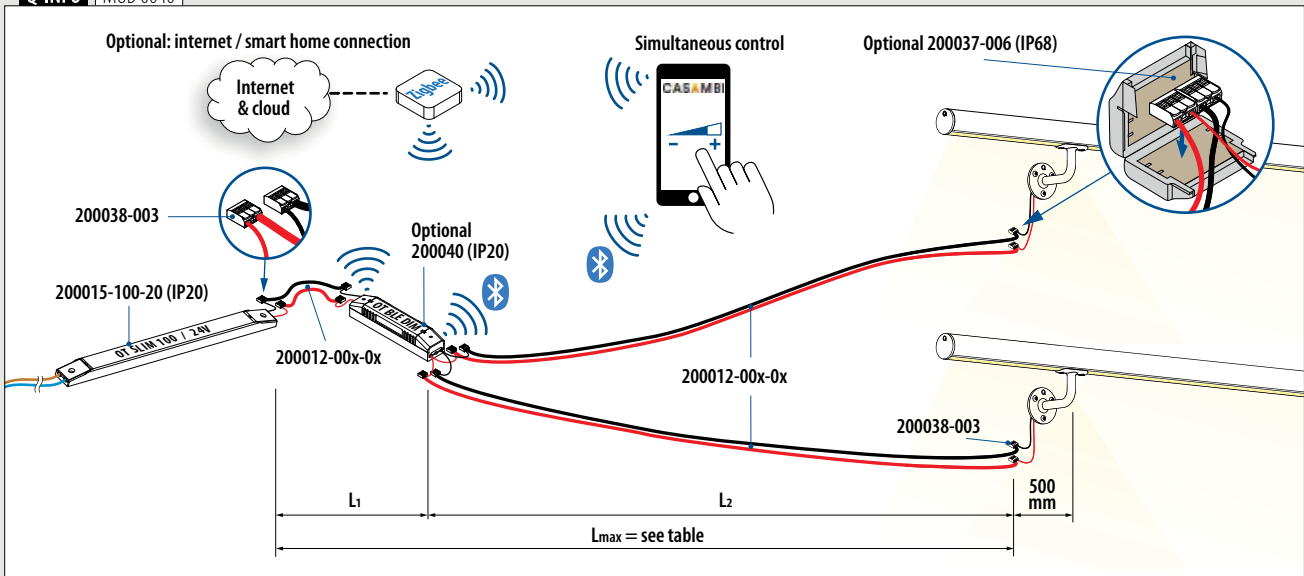

Q-INFO | MOD 0041

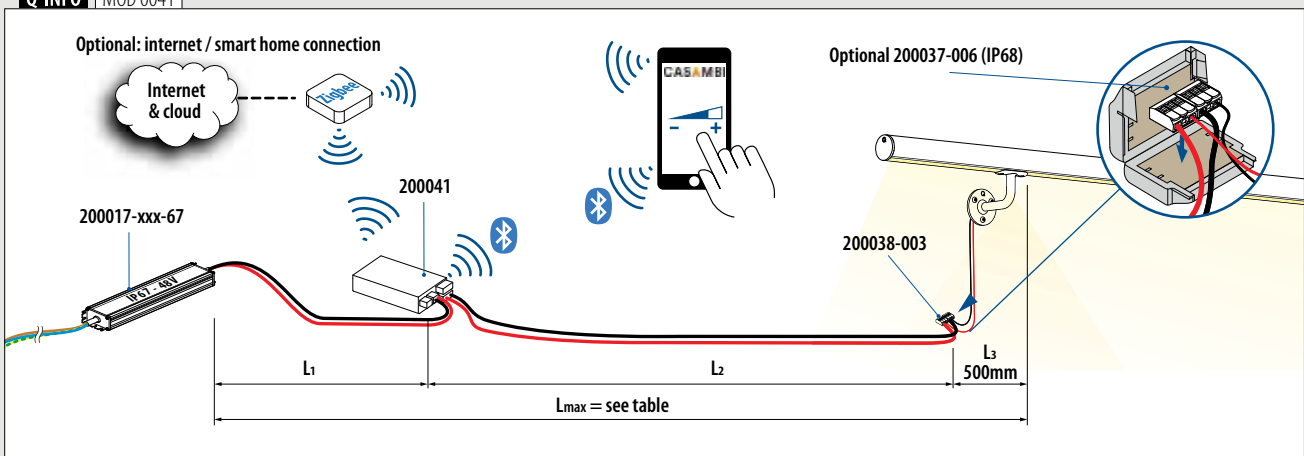

Stromversorgung

Kabelverbinder

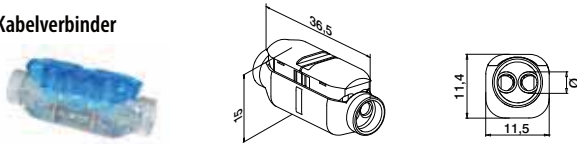

MOD 0030

OUTDOOR	Ø	AWG	Box
200030-68	0,5 - 1 mm ²	17 - 20	15

IP68

Gelbox



MOD 0037

OUTDOOR	Box
200037-006	1

IP68

Kabelsplitter



MOD 0038

INDOOR	Ø	Box
200038-003	0,14 - 4 mm ²	12

IP20

Q-INFO MOD 0030

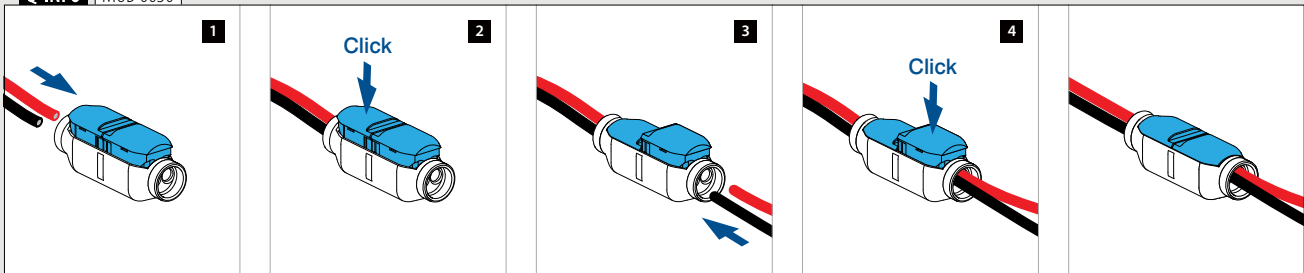

Q-INFO MOD 0038

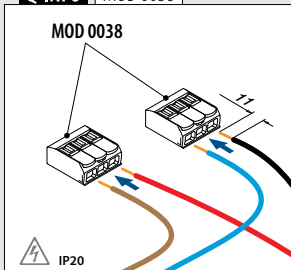

Q-INFO MOD 0038

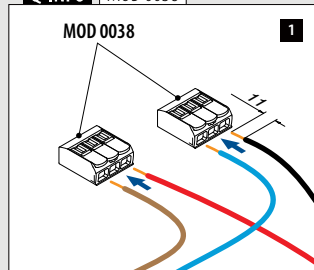

Q-INFO MOD 0038

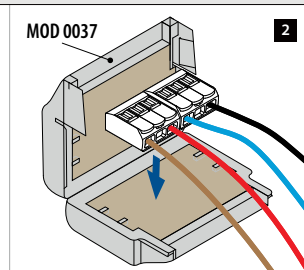

Q-INFO MOD 0038

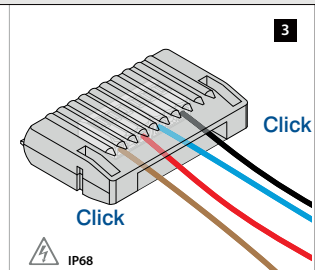

Q-INFO MOD 0038

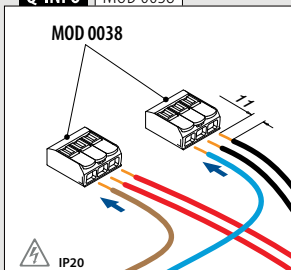

Q-INFO MOD 0038

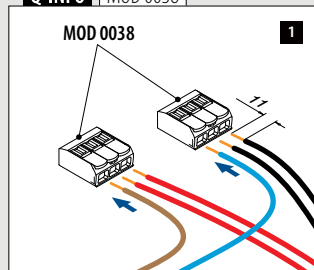

Q-INFO MOD 0038

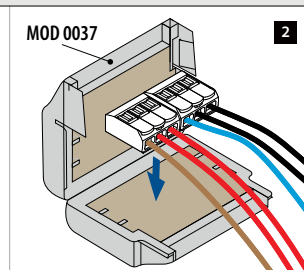

Q-INFO MOD 0038

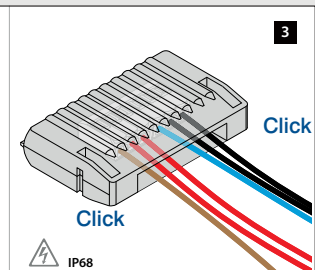

Q-INFO

SICHERHEITSHINWEISE

- Die Elektroinstallation von Netzmodulen darf nur unter Beachtung der gültigen lokalen Vorschriften und Normen durch eine zugelassene Elektrofachkraft erfolgen.
- Achten Sie bei der Inbetriebnahme auf die richtige Polung. Durch falsche Polung kann das Produkt beschädigt werden.
- Zum Betrieb sollten Netzgeräte verwendet werden, bei denen folgende Schutzmaßnahmen gewährleistet sein müssen:
 - Kurzschlusschutz
 - Überlastschutz
 - Übertemperaturschutz
 - Sicherheitskleinspannung SELV (Safety Extra Low Voltage)
- Beachten Sie die maximale Leistung der Ihnen zur Verfügung gestellten Stromversorgung.
- Nur die elektrische Parallelschaltung ermöglicht einen sicheren Betriebszustand.

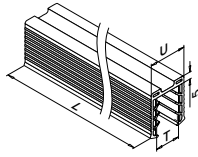
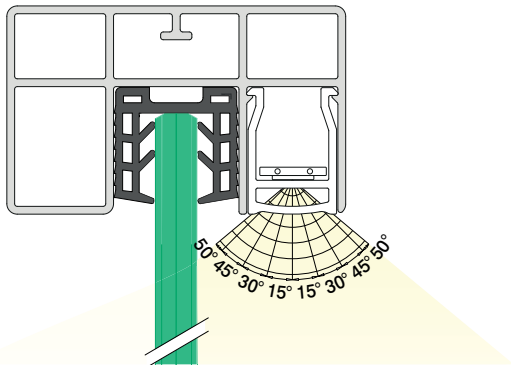

MOD 5124

Zubehör

U = 24 mm

Für monolithisches Glas	T	
205124-050-08	8 - 10	L = 5 m
205124-050-11	12	L = 5 m
205124-050-15	15	L = 5 m
205124-050-19	19	L = 5 m

Für laminiertes Glas

205124-050-08	8,76 - 10,76	L = 5 m
205124-050-11	11,52 - 13,52	L = 5 m
205124-050-17	16,76 - 17,52	L = 5 m
NEW 205124-050-92	20,76 - 21,52	L = 5 m

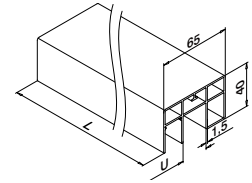
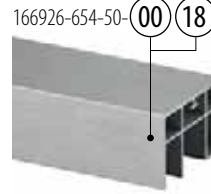

MOD 6926

Aluminium	Roh	U	<input type="checkbox"/>	
166926-654-50-00		24	65 x 40	L = 5 m
Aluminium	Gebürstet			
OUTDOOR				
166926-654-50-18		24	65 x 40	L = 5 m



Internationaler Geschmacksmusterschutz

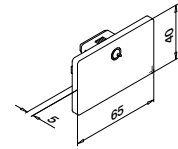

MOD 6734 - EASY HIT®

Aluminium	Roh	Für <input type="checkbox"/>	
166734-654-00		65 x 40	2
Aluminium	Gebürstet		
OUTDOOR			
166734-654-18		65 x 40	2

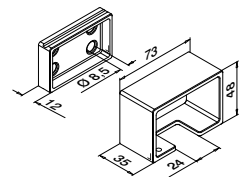

MOD 6545

Aluminium	Roh	Für <input type="checkbox"/>		
166545-654-00		65 x 40	QS-55 470 / QS-20 472	2
Aluminium	Gebürstet			
OUTDOOR				
166545-654-18		65 x 40	QS-55 470 / QS-20 472	2



Internationaler Geschmacksmusterschutz

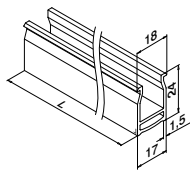

MOD 5091

INDOOR	Transparenz	
155091-025-03	Klar	L = 2,5 m
155091-025-06	Diffus	L = 2,5 m



Internationaler Geschmacksmusterschutz

Q-INFO | MOD 6545 / 5124 / 6926

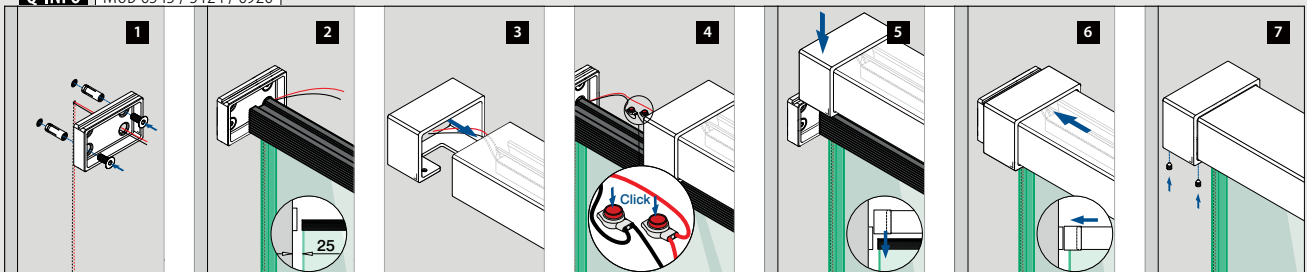

Verbinder

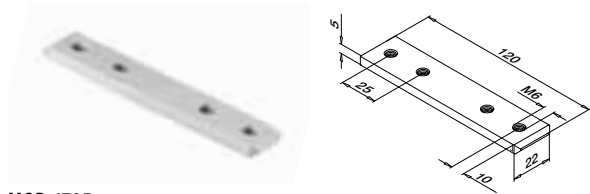

MOD 6795

Aluminium	Roh		
166795-339	QS-261	472	2

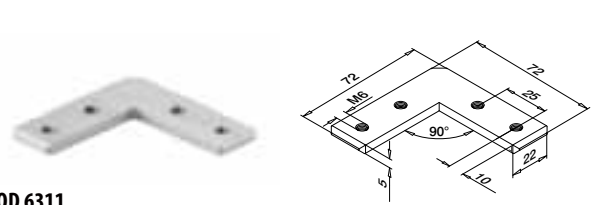

MOD 6311

Aluminium	Roh		
166311-339	QS-261	472	2

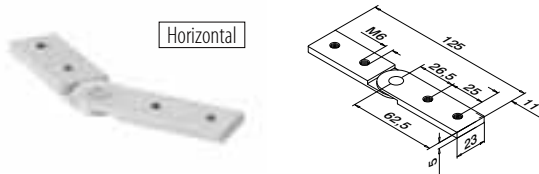

MOD 6797

Aluminium	Roh		
166797	QS-261	472	2

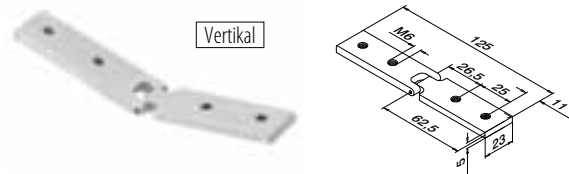

MOD 6798

Aluminium	Roh		
166798	QS-261	472	2

Q-INFO MOD 6311

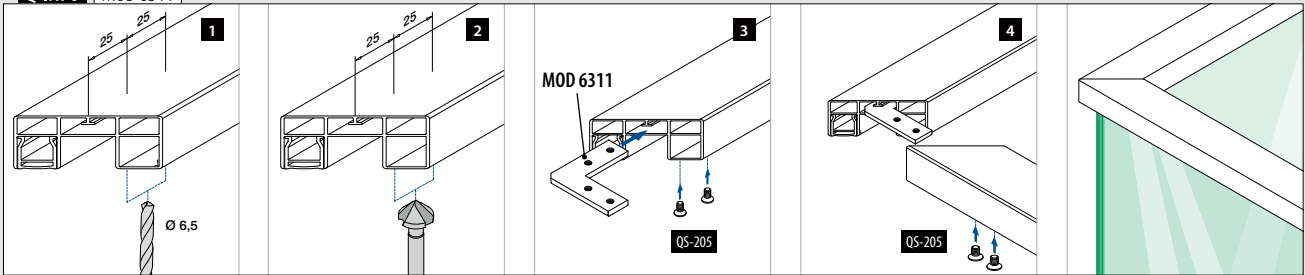

Q-INFO MOD 6797

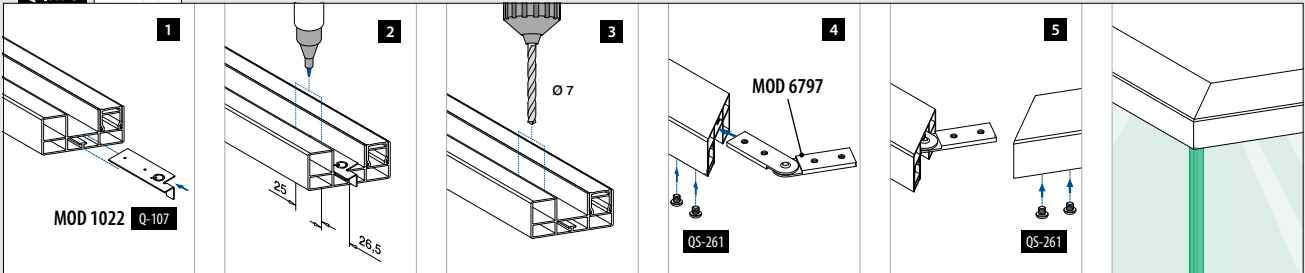

Q-INFO MOD 6798

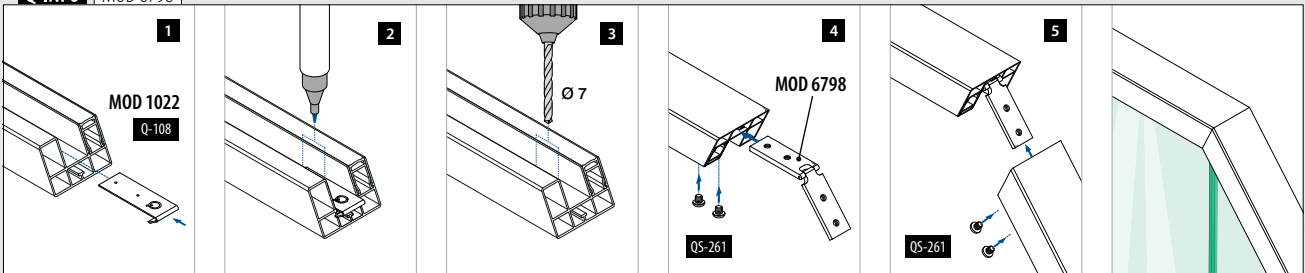

Q-INFO MOD 6798

Nach oben

Schneiden	45°	40°	35°	30°	25°	20°	15°	10°	5°	0°
Aussenwinkel	90°	100°	110°	120°	130°	140°	150°	160°	170°	180°
Abstand zum Rand (x)	30,5	30,0	29,5	29,0	28,5	28,0	27,5	27,0	27,0	26,5

Nach unten

Schneiden	0°	5°	10°	15°	20°	25°	30°	35°	40°	45°
Innenwinkel	180°	170°	160°	150°	140°	130°	120°	110°	100°	90°
Abstand zum Rand (x)	26,5	26,5	26,0	26,0	25,5	25,5	25,0	24,5	24,5	24,0

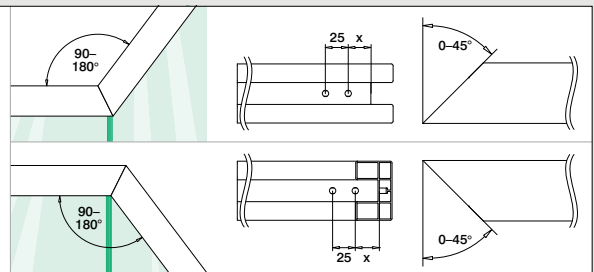

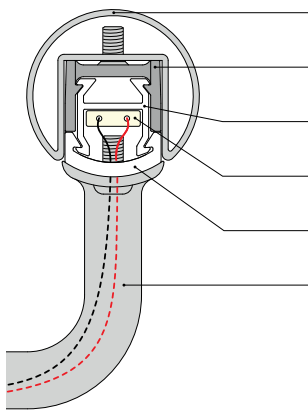

- Glasleistenrohre (U = 24): ■ 257
- Adapter MOD 078x-24: ■ 256
- Trägerprofil: ■ 257
- LED-Bänder: ■ 238, 245
- Abdeckprofil für LED-Bänder: ■ 257
- Handlaufstützen: ■ 260 - 261
- Handlaufadapter MOD 0770 / 0772: ■ 262

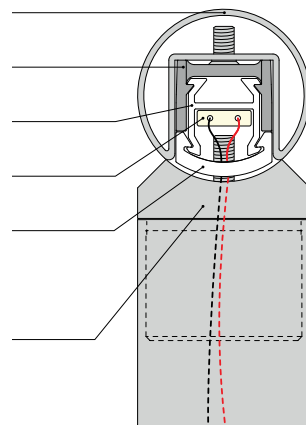

Für Handlaufstützen, fix

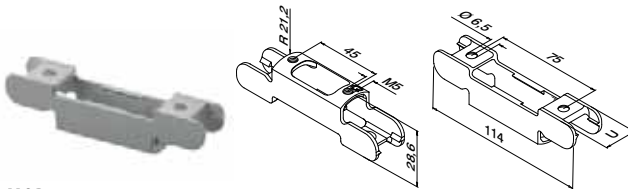

MOD 0781

V4A	316	Gebürstet		
	OUTDOOR	U		
140781-24	24	QS-205 ■ 472	2	

Internationaler Geschmacksmusterschutz

Für Handlaufstützen, justierbar

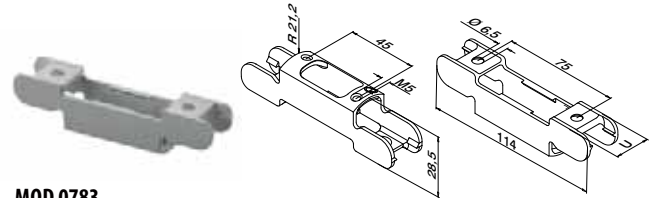

MOD 0783

V4A	316	Gebürstet		
	OUTDOOR	U		
140783-24	24	QS-205 ■ 472	2	

Internationaler Geschmacksmusterschutz

Für Handlaufadapter, fix

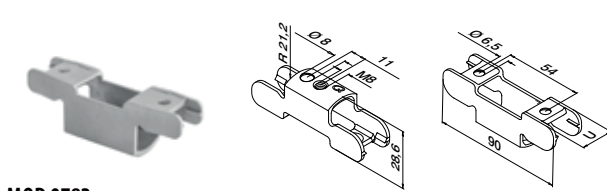

MOD 0782

V4A	316	Gebürstet		
	OUTDOOR	U		
140782-24	24	QS-205 ■ 472	2	

Internationaler Geschmacksmusterschutz



MOD 0780

V4A	316	Gebürstet		
	OUTDOOR	U		
140780-24	24	QS-205 ■ 472	2	

Internationaler Geschmacksmusterschutz

Q-INFO | MOD 0780 / 0781

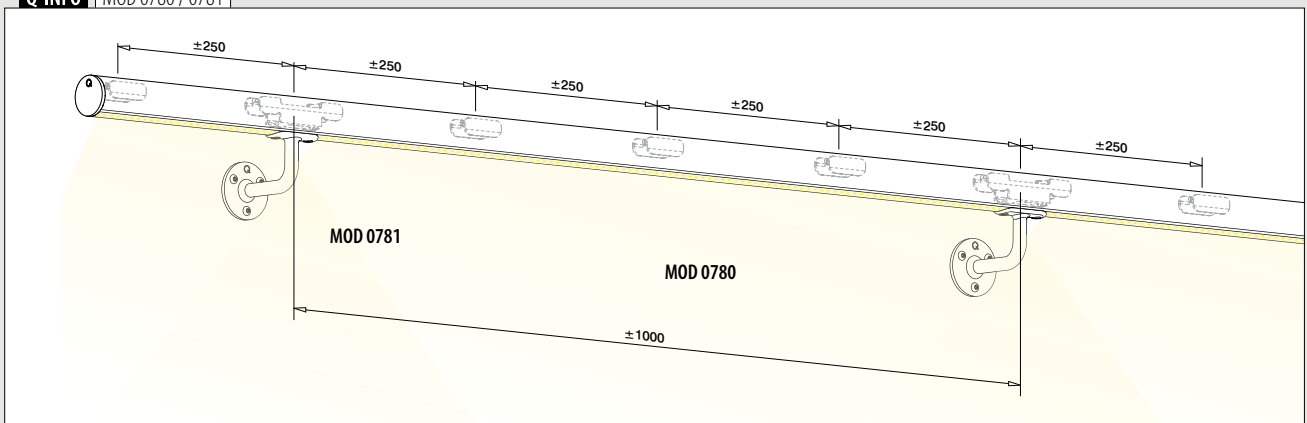

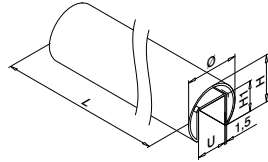

MOD 6920

Ø 42,4 mm

V2A	304	Gebürstet				
INDOOR*			U	Ø	H	H1
136920-042-50-12			24	42,4	37	24
						L = 5 m

V4A	316	Gebürstet				
OUTDOOR			U	Ø	H	H1
146920-042-50-12			24	42,4	37	24
						L = 5 m

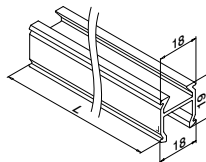

MOD 5092

INDOOR

155092-025

L = 2,5 m

Internationaler Geschmacksmusterschutz

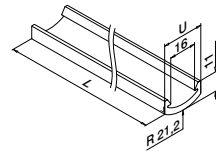

MOD 5090

INDOOR

Transparenz

L = 2,5 m

155090-025-24-03

Klar

L = 2,5 m

155090-025-24-06

Diffus

L = 2,5 m

IK10

Internationaler Geschmacksmusterschutz

Q-INFO MOD 6920

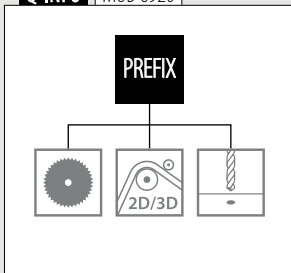

* Auch für Aussenanwendung geeignet bei entsprechenden Bedingungen.

	MOD 6950 (U = 24 mm) 169		MOD 6924 (U = 24 mm) 176 - 182
--	---------------------------------------	--	---

Q-INFO MOD 078x

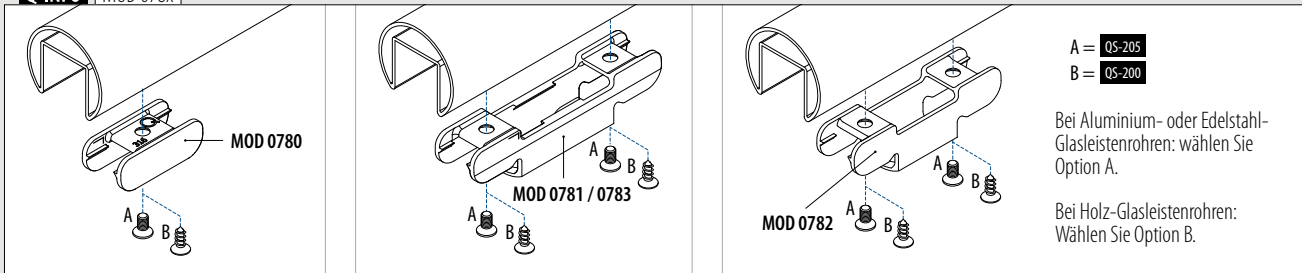

Q-INFO MOD 0783

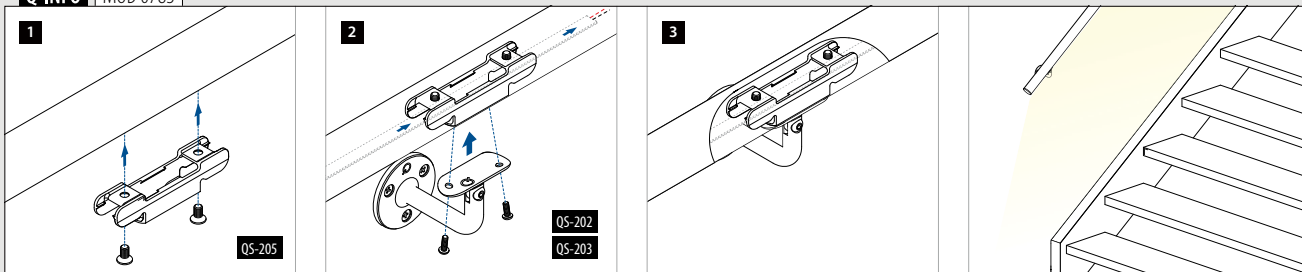

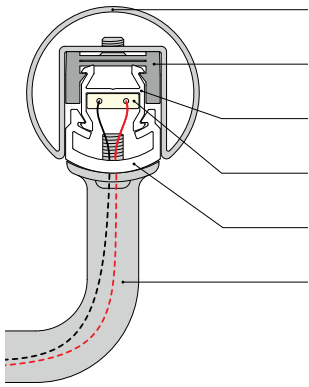

Glasleitenrohre (U = 27): ■ 259

Adapter MOD 078x-27: ■ 258

Trägerprofil: ■ 259

LED-Bänder: ■ 238, 245

Abdeckprofil für LED-Bänder: ■ 259

Handlaufstützen: ■ 260 - 261

Handlaufadapter MOD 0771 / 0773: ■ 262

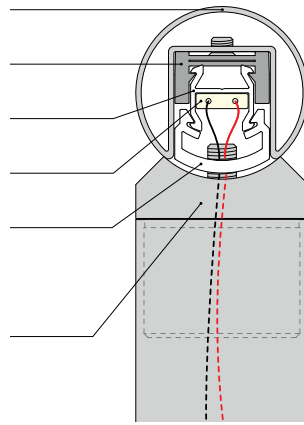

Für Handlaufstützen, fix

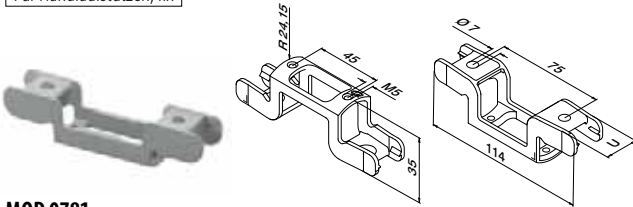

MOD 0781

V4A	316	Gebürstet		
	OUTDOOR	U		
140781-27	27	QS-205 ■ 472	2	

Internationaler Geschmacksmusterschutz

Für Handlaufstützen, justierbar

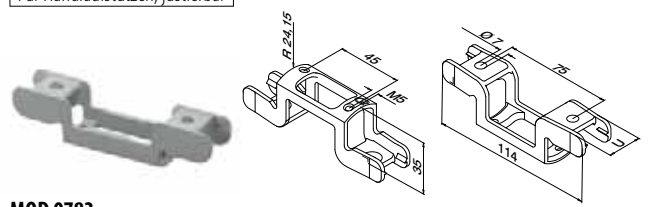

MOD 0783

V4A	316	Gebürstet		
	OUTDOOR	U		
140783-27	27	QS-205 ■ 472	2	

Internationaler Geschmacksmusterschutz

Für Handlaufadapter, fix

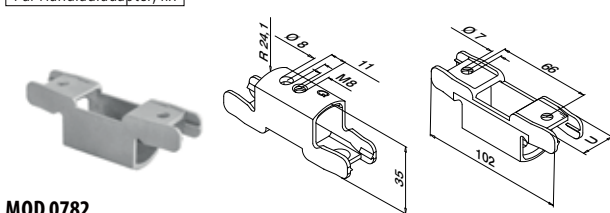

MOD 0782

V4A	316	Gebürstet		
	OUTDOOR	U		
140782-27	27	QS-205 ■ 472	2	

Internationaler Geschmacksmusterschutz



MOD 0780

V4A	316	Gebürstet		
	OUTDOOR	U		
140780-27	27	QS-205 ■ 472	2	

Internationaler Geschmacksmusterschutz

Q-INFO | MOD 0780 / 0781

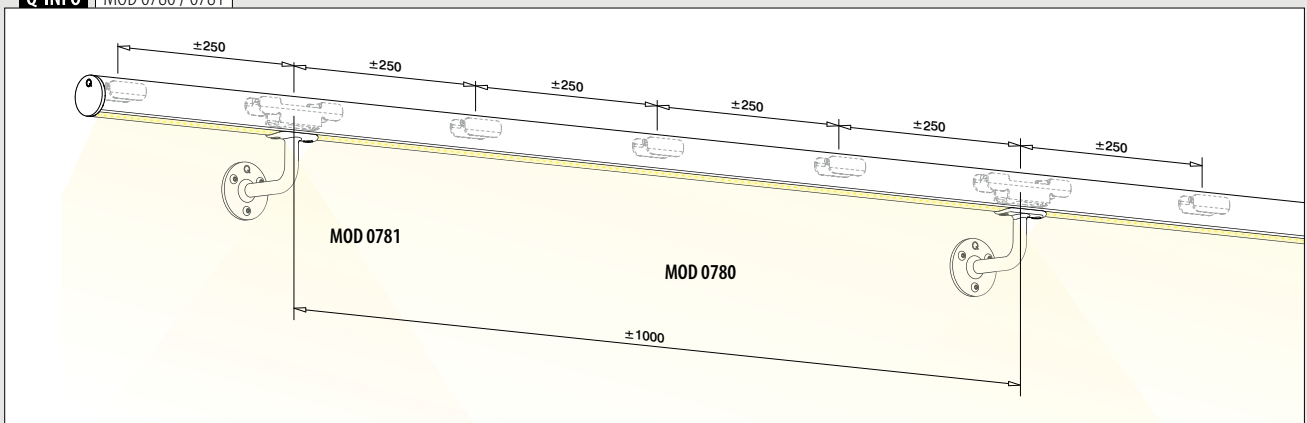

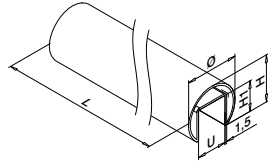

MOD 6920

Ø 48,3 mm

V2A	304	Gebürstet				
INDOOR*			U	H	H1	
136920-048-50-12	27	48,3	42,6	30	L = 5 m	

V4A	316	Gebürstet				
OUTDOOR			U	H	H1	
146920-048-50-12	27	48,3	42,6	30	L = 5 m	

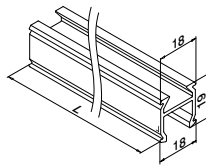

MOD 5092

INDOOR

155092-025

L = 2,5 m

Internationaler Geschmacksmusterschutz

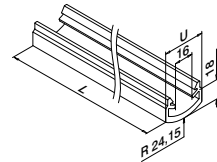

MOD 5090

INDOOR

Transparenz

155090-025-27-03

Klar

L = 2,5 m

155090-025-27-06

Diffus

L = 2,5 m

IK10

Internationaler Geschmacksmusterschutz

* Auch für Aussenanwendung geeignet bei entsprechenden Bedingungen.

Q-INFO MOD 078x

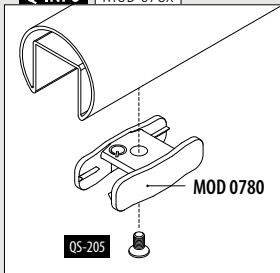

MOD 0781 / 0783

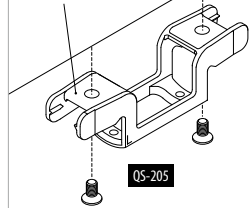

MOD 0782

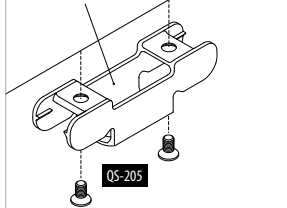

Q-INFO MOD 6920

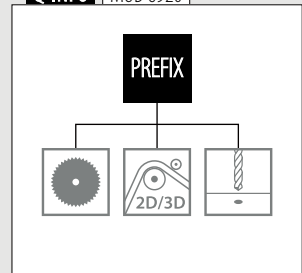

Q-INFO MOD 0783

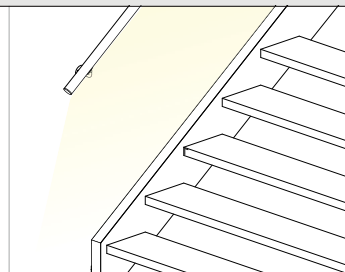
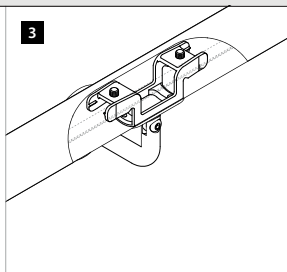
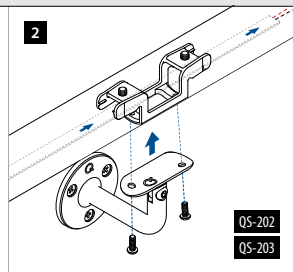
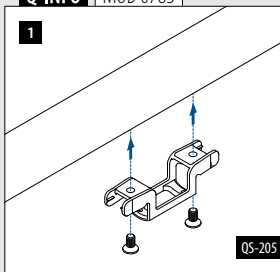

Mit Kabelkanal

Für rundes Rohr

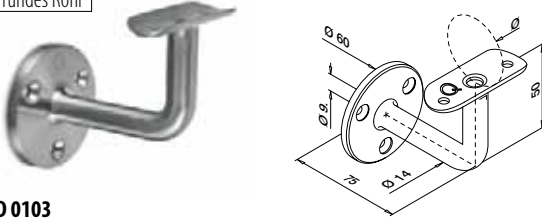

MOD 0103

V2A	304	Gebürstet				
INDOOR*						
130103-042-12	42,4	MOD 0781-24	QS-7	▣471 / QS-202	▣472	2
130103-048-12	48,3	MOD 0781-27	QS-7	▣471 / QS-202	▣472	2

V4A	316	Gebürstet				
OUTDOOR						
140103-042-12	42,4	MOD 0781-24	QS-50	▣471 / QS-203	▣472	2
140103-048-12	48,3	MOD 0781-27	QS-50	▣471 / QS-203	▣472	2



Für rundes Rohr

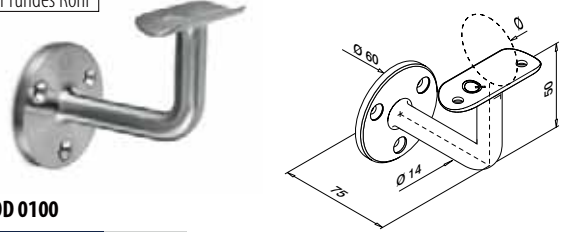

MOD 0100

V2A	304	Gebürstet				
INDOOR*						
130100-042-12	42,4	MOD 0781-24	QS-7	▣471 / QS-202	▣472	2
130100-048-12	48,3	MOD 0781-27	QS-7	▣471 / QS-202	▣472	2

V4A	316	Gebürstet				
OUTDOOR						
140100-042-12	42,4	MOD 0781-24	QS-50	▣471 / QS-203	▣472	2
140100-048-12	48,3	MOD 0781-27	QS-50	▣471 / QS-203	▣472	2



Für rundes Rohr

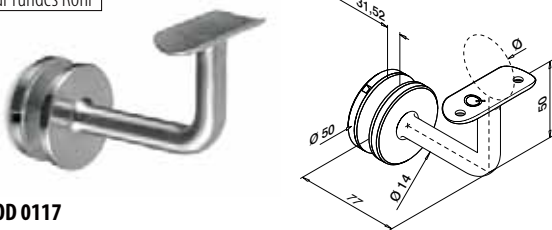

MOD 0117

V2A	304	Gebürstet				
INDOOR*						
130117-042-12	42,4	MOD 0781-24	QS-202	▣472		2
130117-048-12	48,3	MOD 0781-27	QS-202	▣472		2

V4A	316	Gebürstet				
OUTDOOR						
140117-042-12	42,4	MOD 0781-24	QS-203	▣472		2
140117-048-12	48,3	MOD 0781-27	QS-203	▣472		2



SPOTLIGHT

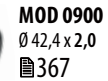

LINEAR LIGHT

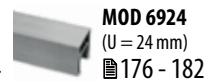
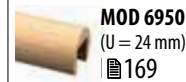

Q-INFO MOD 0117

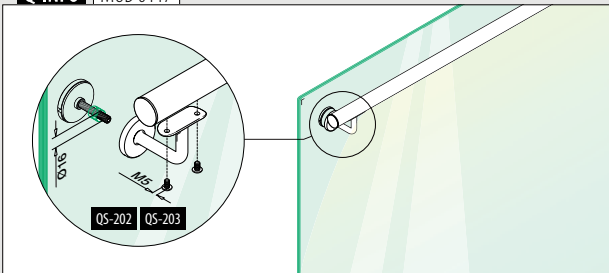

Q-INFO MOD 0103

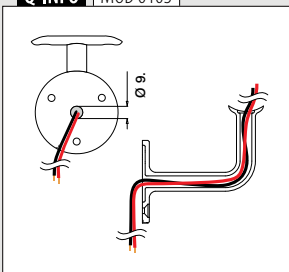

Q-INFO MOD 0103 / 0117

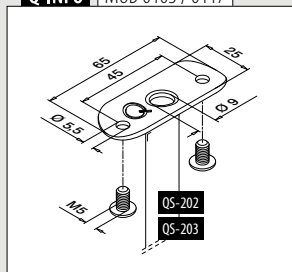

Q-INFO MOD 0103

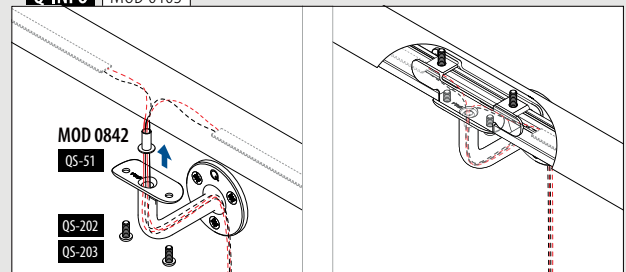

* Auch für Aussenanwendung geeignet bei entsprechenden Bedingungen.

Für rundes Rohr
Mit Kabelkanal

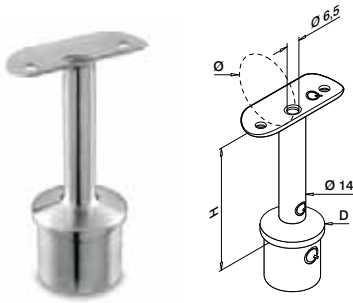

MOD 0710

V4A	316	Gebürstet					
OUTDOOR			D	Ø	H		
140710-042-01-12	42,4 x 2,0	42,4	MOD 0781-24	79	QS-203 472	2	

MOD 0711

V4A	316	Gebürstet					
OUTDOOR			D	Ø	H		
140711-048-01-12	48,3 x 2,0	48,3	MOD 0781-27	80	QS-203 472	2	



Für rundes Rohr

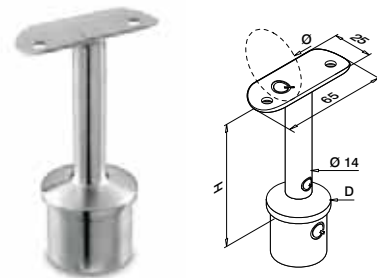

MOD 0710

V2A	304	Gebürstet					
INDOOR*			D	Ø	H		
130710-042-00-12	42,4 x 2,0	42,4	MOD 0781-24	79	QS-202 472	2	

V4A 316 Gebürstet
OUTDOOR

140710-042-00-12	42,4 x 2,0	42,4	MOD 0781-24	79	QS-203 472	2	
------------------	------------	------	-------------	----	---------------	---	--

MOD 0711

V2A	304	Gebürstet					
INDOOR*			D	Ø	H		
130711-048-00-12	48,3 x 2,0	48,3	MOD 0781-27	80	QS-202 472	2	

V4A 316 Gebürstet
OUTDOOR

140711-048-00-12	48,3 x 2,0	48,3	MOD 0781-27	80	QS-203 472	2	
------------------	------------	------	-------------	----	---------------	---	--



Für rundes Rohr

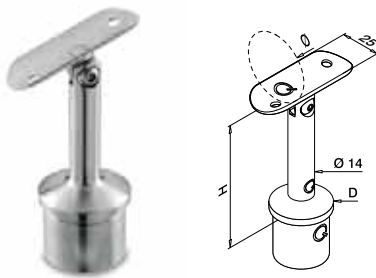

MOD 0718

V2A	304	Gebürstet					
INDOOR*			D	Ø	H		
130718-042-12	42,4 x 2,0	42,4	MOD 0783-24	79	QS-202 472	2	

V4A 316 Gebürstet
OUTDOOR

140718-042-12	42,4 x 2,0	42,4	MOD 0783-24	79	QS-203 472	2	
---------------	------------	------	-------------	----	---------------	---	--

MOD 0719

V2A	304	Gebürstet					
INDOOR*			D	Ø	H		
130719-048-12	48,3 x 2,0	48,3	MOD 0783-27	80	QS-202 472	2	

V4A 316 Gebürstet
OUTDOOR

140719-048-12	48,3 x 2,0	48,3	MOD 0783-27	80	QS-203 472	2	
---------------	------------	------	-------------	----	---------------	---	--

Q-INFO MOD 0710 / 0711-04x-01

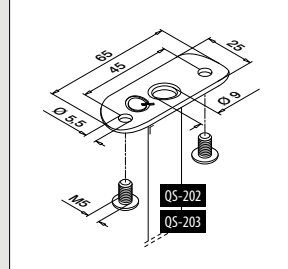

Q-INFO MOD 0710 / 0711-04x-00

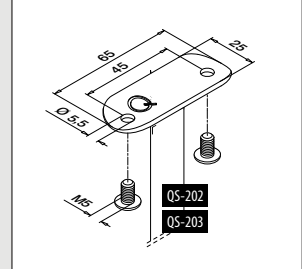

Q-INFO MOD 0710 / 0711-04x-01

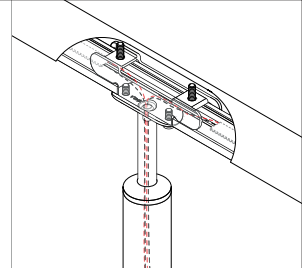
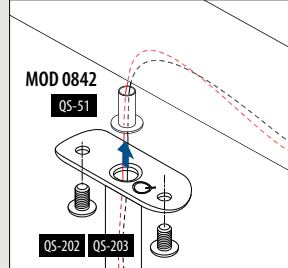

Q-INFO MOD 0710 / 0711-04x-01

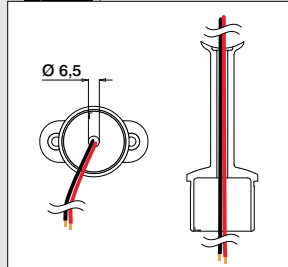

Q-INFO MOD 0718 / 0719

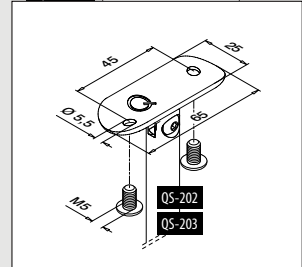

Mit Kabelkanal

Für rundes Rohr

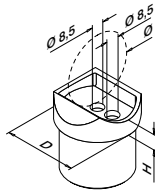

MOD 0770

V2A	304	Gebürstet						
INDOOR*			D	Ø	H			
130770-042-12	42,4 x 2,0	42,4	MOD 0782-24	9	QS-26	472	2	

V4A	316	Gebürstet						
OUTDOOR			D	Ø	H			
140770-042-12	42,4 x 2,0	42,4	MOD 0782-24	9	QS-27	472	2	

MOD 0772

V2A	304	Gebürstet						
INDOOR*			D	Ø	H			
SELL OUT 130772-042-12	42,4 x 2,6	42,4	MOD 0782-24	9	QS-26	472	2	

V4A	316	Gebürstet						
OUTDOOR			D	Ø	H			
SELL OUT 140772-042-12	42,4 x 2,6	42,4	MOD 0782-24	9	QS-27	472	2	

MOD 0771

V2A	304	Gebürstet						
INDOOR*			D	Ø	H			
130771-048-12	48,3 x 2,0	48,3	MOD 0782-27	11	QS-26	472	2	

V4A	316	Gebürstet						
OUTDOOR			D	Ø	H			
140771-048-12	48,3 x 2,0	48,3	MOD 0782-27	11	QS-27	472	2	

MOD 0773

V2A	304	Gebürstet						
INDOOR*			D	Ø	H			
130773-048-12	48,3 x 2,6	48,3	MOD 0782-27	11	QS-26	472	2	

V4A	316	Gebürstet						
OUTDOOR			D	Ø	H			
140773-048-12	48,3 x 2,6	48,3	MOD 0782-27	11	QS-27	472	2	



Internationaler Geschmacksmusterschutz

* Auch für Aussenanwendung geeignet bei entsprechenden Bedingungen.

SELL OUT Nur solange der Vorrat reicht.

Q-INFO

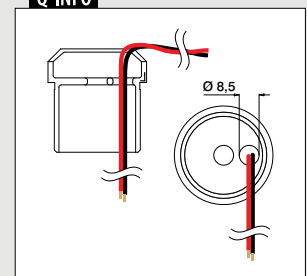
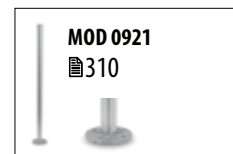

Q-INFO

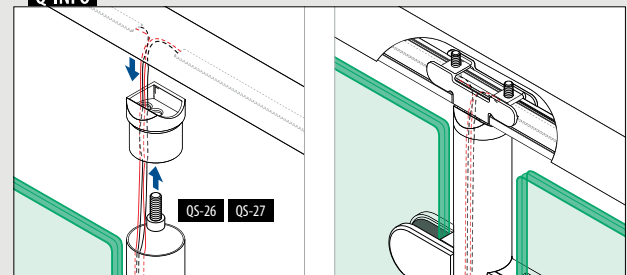

Q-INFO

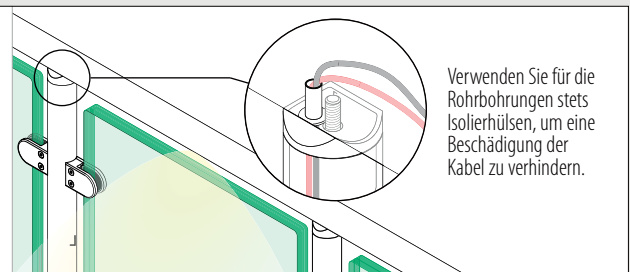
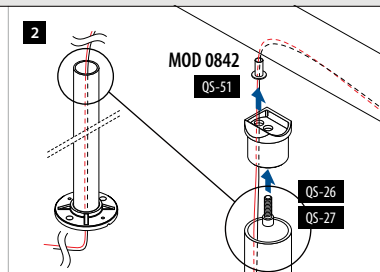
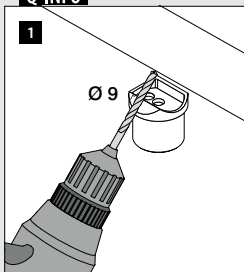

Glasleistenrohre

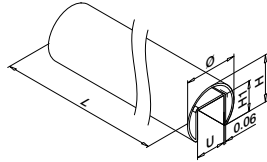

MOD 6920

Ø 42,4 mm

V2A	304	Gebürstet				
INDOOR*		U	H	H1		
136920-042-50-12	24	37	24	L = 5 m		

V4A	316	Gebürstet				
OUTDOOR		U	H	H1		
146920-042-50-12	24	37	24	L = 5 m		

Ø 48,3 mm

V2A	304	Gebürstet				
INDOOR*		U	H	H1		
136920-048-50-12	27	42,6	30	L = 5 m		

V4A	316	Gebürstet				
OUTDOOR		U	H	H1		
146920-048-50-12	27	42,6	30	L = 5 m		



Glasleistenrohr/Pfosten-Verbinder

Justierbar

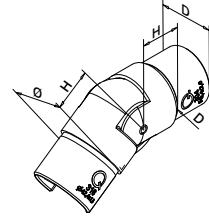

MOD 6304

V4A	316	Gebürstet				
OUTDOOR		Ø	D	H		
146304-242-01-12	42,4 x 1,5	42,4 x 2,0	27	2		
146304-248-01-12	48,3 x 1,5	48,3 x 2,0	30	2		
146304-048-01-12	48,3 x 1,5	48,3 x 2,6	30	2		

NEW

Glasleistenrohr/Rohr-Verbinder

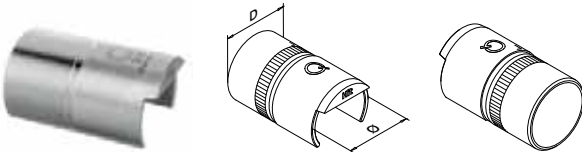

MOD 5793 - EASY HIT®

V4A	316	Roh			
OUTDOOR		Für Rohr Ø	Für Rohr D		
145793-042	42,4 x 1,5	42,4 x 2,0	2		
145793-048	48,3 x 1,5	48,3 x 2,0	2		



Internationaler Geschmacksmusterschutz

Q-INFO MOD 6304

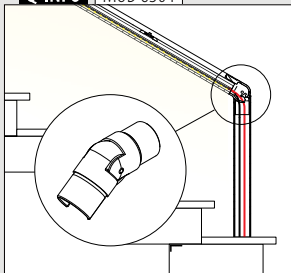

Q-INFO MOD 5793

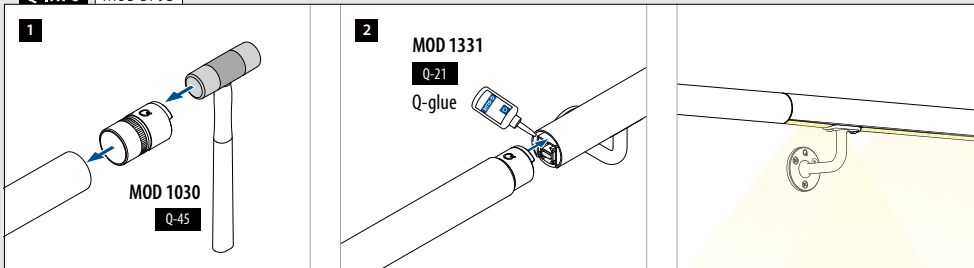

Q-INFO MOD 6920

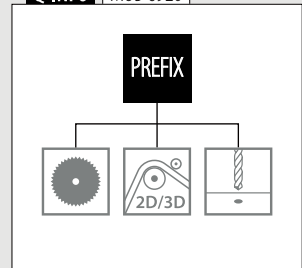

Verbinder

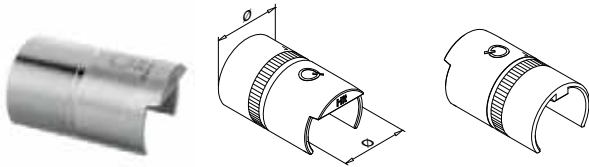

MOD 6792 - EASY HIT®

V2A	304	Roh			
INDOOR*		Für Ø			
136792-042		42,4 x 1,5		2	
136792-048		48,3 x 1,5		2	
V4A	316	Roh			
OUTDOOR					
146792-042		42,4 x 1,5		2	
146792-048		48,3 x 1,5		2	



MOD 6313

V2A	304	Gebürstet			
INDOOR*		Für Ø	H		
136313-042-12		42,4 x 1,5	30	2	
136313-048-12		48,3 x 1,5	35	2	
V4A	316	Gebürstet			
OUTDOOR					
146313-042-12		42,4 x 1,5	30	2	
146313-048-12		48,3 x 1,5	35	2	



Verbinder

Justierbar



MOD 6302

V2A	304	Gebürstet			
INDOOR*		Für Ø	H		
136302-042-02-12		42,4 x 1,5	30	2	
136302-048-02-12		48,3 x 1,5	35	2	
V4A	316	Gebürstet			
OUTDOOR					
146302-042-02-12		42,4 x 1,5	30	2	
146302-048-02-12		48,3 x 1,5	35	2	



MOD 6302

V2A	304	Gebürstet			
INDOOR*		Für Ø	H		
136302-042-01-12		42,4 x 1,5	30	2	
136302-048-01-12		48,3 x 1,5	35	2	
V4A	316	Gebürstet			
OUTDOOR					
146302-042-01-12		42,4 x 1,5	30	2	
146302-048-01-12		48,3 x 1,5	35	2	



MOD 6312

V2A	304	Gebürstet			
INDOOR*		Ø	H		
136312-042-12		42,4 x 1,5	27	2	
136312-048-12		48,3 x 1,5	30	2	
V4A	316	Gebürstet			
OUTDOOR					
146312-042-12		42,4 x 1,5	27	2	
146312-048-12		48,3 x 1,5	30	2	



* Auch für Aussenanwendung geeignet bei entsprechenden Bedingungen.

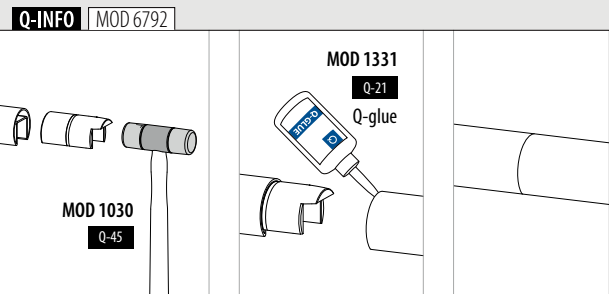

Endkappen



MOD 6732

V2A	304	Gebürstet			
INDOOR*		Für Ø			
136732-042-12	42,4	1,5	2		
136732-048-12	48,3	1,5	2		
V4A	316	Gebürstet			
OUTDOOR		Für Ø			
146732-042-12	42,4	1,5	2		
146732-048-12	48,3	1,5	2		



Endbögen zur Wand

Links / rechts

Mit Kabelkanal

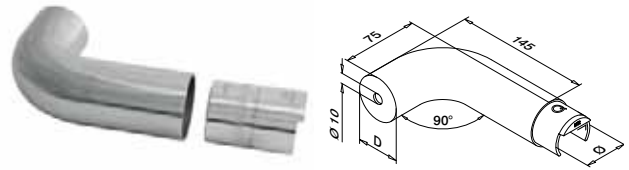

MOD 6739

V4A	316	Gebürstet			
OUTDOOR		D	Für Ø		
146739-042-12	42,4	42,4 x 1,5	2		
146739-048-12	48,3	48,3 x 1,5	2		



Wandflansche

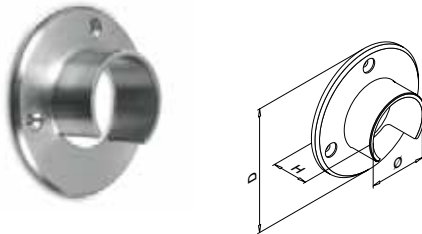

MOD 6505

V2A	304	Gebürstet					
INDOOR*		Ø	D	H			
136505-042-12	42,4	90	30	QS-5	471	2	
136505-048-12	48,3	95	35	QS-5	471	2	
V4A	316	Gebürstet					
OUTDOOR		Ø	D	H			
146505-042-12	42,4	90	30	QS-6	471	2	
146505-048-12	48,3	95	35	QS-6	471	2	



Mit Kabelkanal

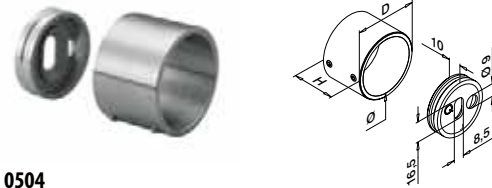

MOD 0504

V2A	304	Gebürstet					
INDOOR*		Ø	D	H			
130504-042-12	42,4	50	35	QS-55	470 / QS-21	472 2	
130504-048-12	48,3	56	35	QS-55	470 / QS-21	472 2	
V4A	316	Gebürstet					
OUTDOOR		Ø	D	H			
140504-042-12	42,4	50	35	QS-55	470 / QS-22	472 2	
140504-048-12	48,3	56	35	QS-55	470 / QS-22	472 2	



Q-INFO MOD 6739

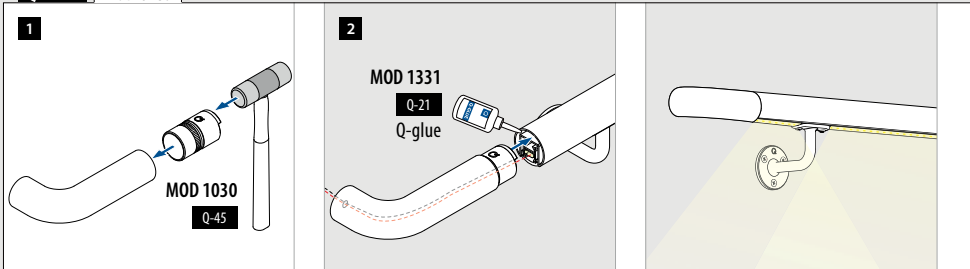

Q-INFO MOD 6739

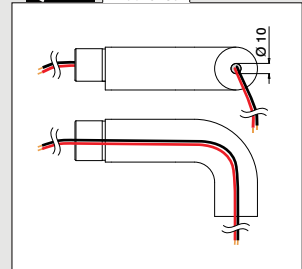

Q-INFO MOD 0504

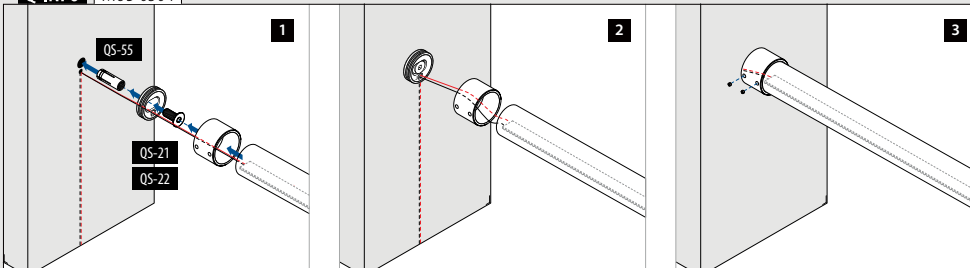

Q-INFO MOD 0504

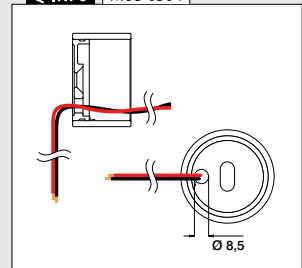

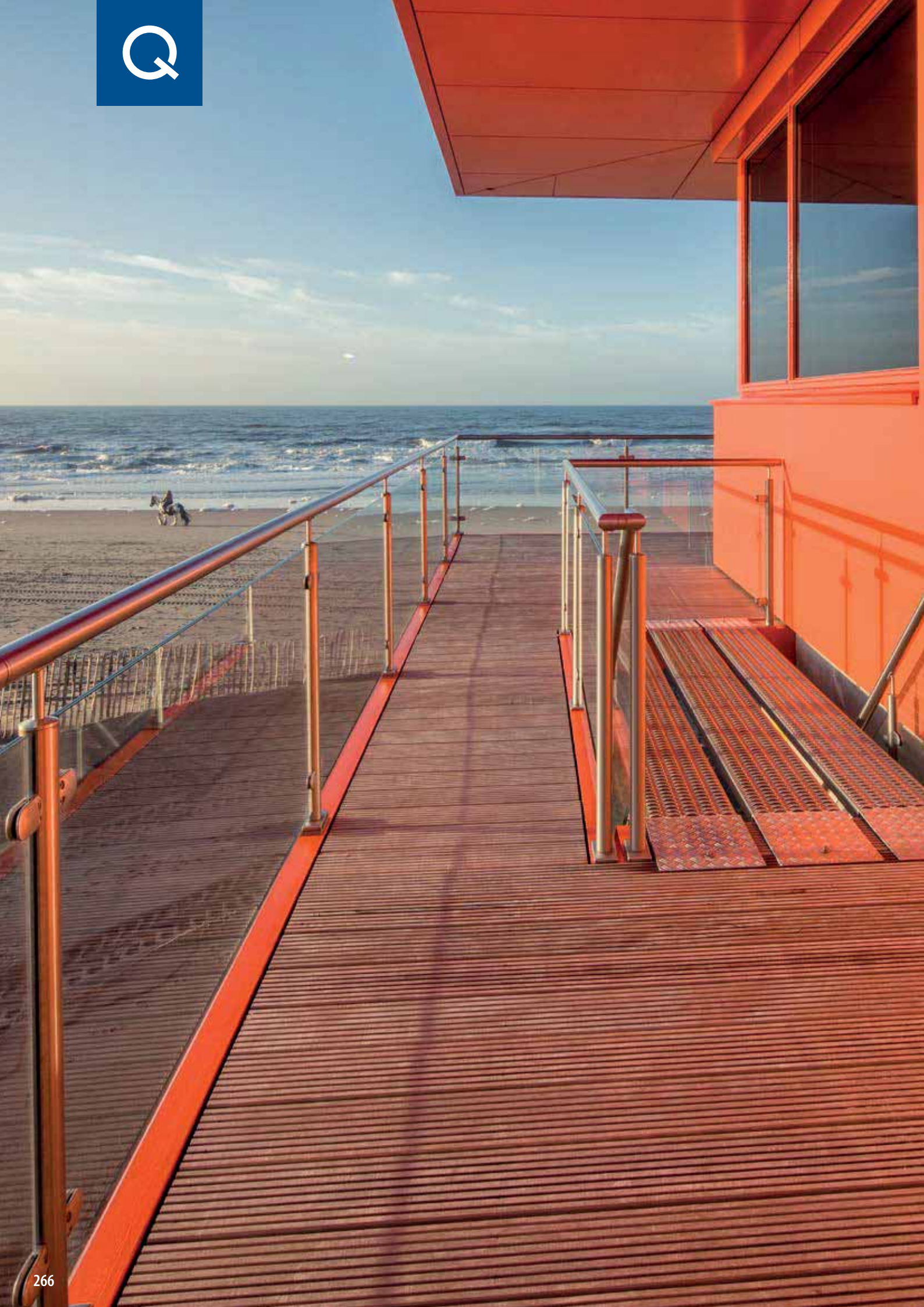

PFOSTEN- GELÄNDER- SYSTEME

Easy Alu	268 - 281
Square Line® 40x10	282 - 283
Square Line® 40x20	284 - 287
Square Line® 40x40	288 - 301
Square Line® 60x30	302 - 307
Q-line	308 - 359
Barrier Line	360 - 361
Q-line hochglanzpoliert	362 - 371
Schweissteile	372 - 379
Bendywood	382 - 383
Naturail	384 - 385
Füllungen	386 - 419



EASY ALU

Beanspruchung:	Leicht und mittel
Verwendung:	Innen- und Aussenbereich
Montage:	Boden- und Seitenmontage
Anwendung:	Balkone, Galerien, Wege, Abtrennungen, Treppen und französische Balkone
Material:	Aluminium (roh, gebürstet anodisiert oder pulver- beschichtet)
Glasstärke:	8 bis 10,76 mm

Finden Sie alle Informationen
zu Easy Alu online:



[https://q-ne.ws/
EasyAlu23](https://q-ne.ws/EasyAlu23)



Schnelle Montage, maximaler Komfort

Easy Alu bietet Ihnen alle Vorteile eines hochwertigen Aluminiumgeländers und vereint dabei die gewohnt hohe Q-railing Qualität mit einer beeindruckenden Optik. Profitieren Sie von einer hohen Kosteneffizienz, vielfältigen Anpassungsmöglichkeiten und der Tatsache, dass Sie die Komponenten in Ihrer Werkstatt zu kompletten Geländermodulen vormontieren können. Noch schneller und einfacher geht es, wenn Sie bereits baustellenfertige Module bestellen, die nach Ihren Spezifikationen massgefertigt werden. Einfach am Boden verankern und fertig!

Easy Alu	CH Bodenmontage	CH Seitenmontage
Max. Holmlast (kN/m)	0,8	0,8
Max. Pfostenabstand (Meter)	1,2	1,0



Bitte beachten Sie die Spezifikationen wie Befestigungs- und Glasmasse sowie Glastype der jeweiligen Zertifikate. Für weitere Informationen besuchen Sie www.q-railing.com/zertifikate

International getestet/berechnet/zertifiziert:



- 1 Beinhaltet das Glass Wing Gummi: Setzen Sie das Glas schnell und ohne hohen Krafteinsatz in die Profile ein. Das Gummi legt sich fest um das Glas.
- 2 Wählen Sie aus drei Bestelloptionen.
- 3 Nivellierblock zur Justierung des Geländers.



EASY ALU FÜLLUNGEN

Glas

- Glas
 - Glas mit Mittelstrebe
- Auf Anfrage erhältlich:
- Stabausfachung
 - Blechfüllung



386 - 387

3 BESTELLOPTIONEN

281



Geländerpfosten, Bodenmontage

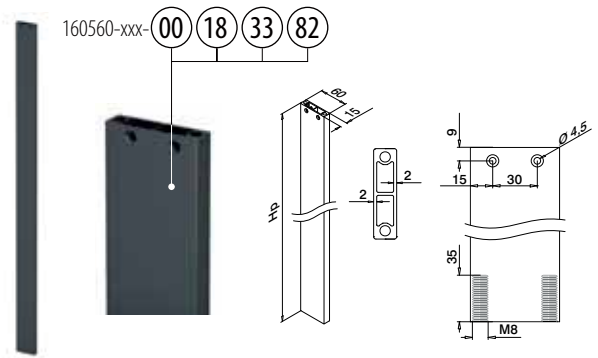
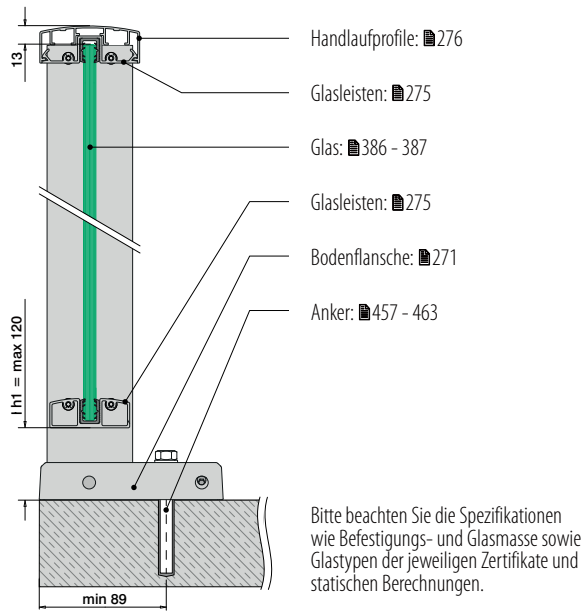

MOD 0560

Aluminium	Roh	Hp		
160560-087-00		865	QS-30 ■472	1
160560-097-00		965	QS-30 ■472	1
160560-107-00		1065	QS-30 ■472	1
160560-117-00		1165	QS-30 ■472	1

Aluminium	Gebürstet	OUTDOOR		
160560-087-18		865	QS-30 ■472	1
160560-097-18		965	QS-30 ■472	1
160560-107-18		1065	QS-30 ■472	1
160560-117-18		1165	QS-30 ■472	1

Aluminium	Pulverbeschichtet RAL 7016, strukturiert	OUTDOOR		
160560-087-33		865	QS-30 ■472	1
160560-097-33		965	QS-30 ■472	1
160560-107-33		1065	QS-30 ■472	1
160560-117-33		1165	QS-30 ■472	1

Aluminium	Black Line	OUTDOOR		
NEW 160560-087-82		865	QS-30 ■472	1
NEW 160560-097-82		965	QS-30 ■472	1
NEW 160560-107-82		1065	QS-30 ■472	1
NEW 160560-117-82		1165	QS-30 ■472	1



Berechnungen – Geländerpfosten, Bodenmontage

Geländerhöhe (H) – 35 mm = Höhe Geländerpfosten (Hp)

Geländerhöhe (H)	Höhe Geländerpfosten (Hp)
900 mm	865 mm
1000 mm	965 mm
1100 mm	1065 mm
1200 mm	1165 mm

Q-INFO

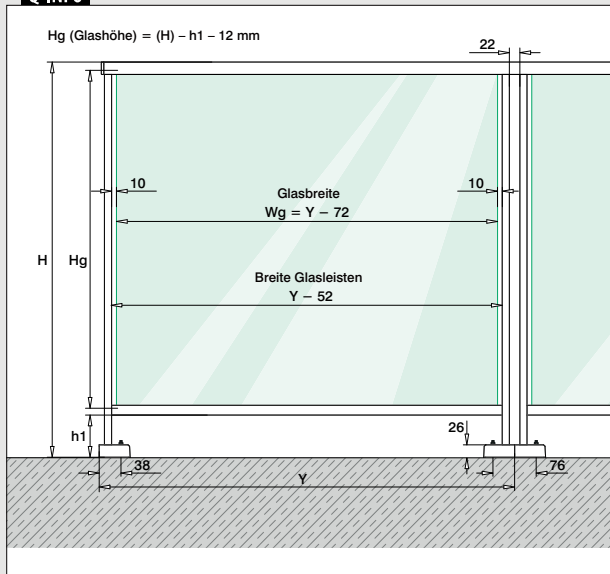

Q-INFO Aluminium

00

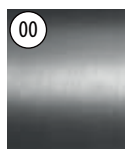

Roh

18

Gebürstet,
anodisiert

33 RAL 7016

Pulver-
beschichtet
Anthrazitgrau,
matt, strukturiert

82 RAL 9005

Pulver-
beschichtet
Schwarz, matt,
strukturiert

Q-INFO

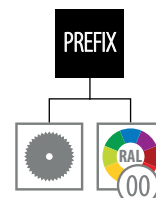

Bodenflansche, Bodenmontage

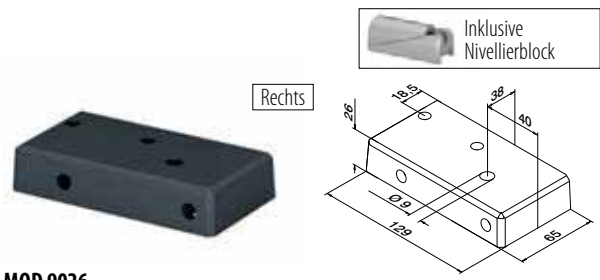
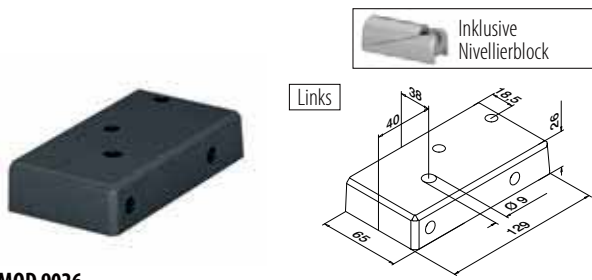

MOD 9026

Aluminium	Roh		
169026-009-01-00		457 - 463	1
Aluminium	Gebürstet		
OUTDOOR			
169026-009-01-18		457 - 463	1
Aluminium	Pulverbeschichtet RAL 7016, strukturiert		
OUTDOOR			
169026-009-01-33		457 - 463	1
Aluminium	Black Line		
OUTDOOR			
NEW	169026-009-01-82	457 - 463	1

MOD 9026

Aluminium	Roh		
169026-009-02-00		457 - 463	1
Aluminium	Gebürstet		
OUTDOOR			
169026-009-02-18		457 - 463	1
Aluminium	Pulverbeschichtet RAL 7016, strukturiert		
OUTDOOR			
169026-009-02-33		457 - 463	1
Aluminium	Black Line		
OUTDOOR			
NEW	169026-009-02-82	457 - 463	1

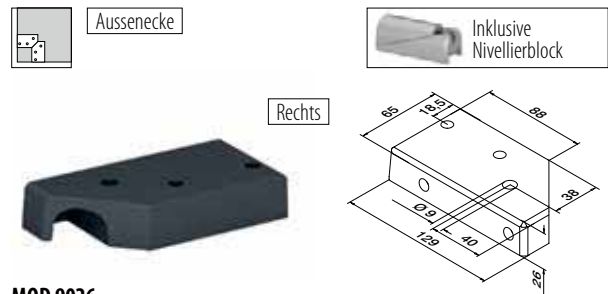
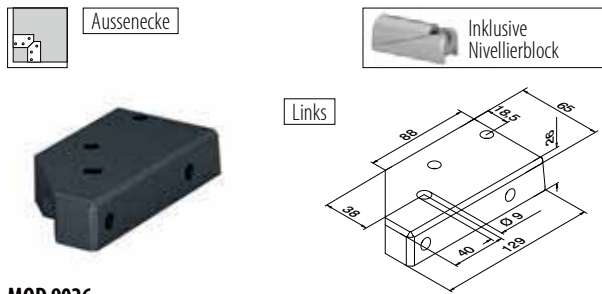

MOD 9026

Aluminium	Roh		
169026-009-91-00		457 - 463	1
Aluminium	Gebürstet		
OUTDOOR			
169026-009-91-18		457 - 463	1
Aluminium	Pulverbeschichtet RAL 7016, strukturiert		
OUTDOOR			
169026-009-91-33		457 - 463	1
Aluminium	Black Line		
OUTDOOR			
NEW	169026-009-91-82	457 - 463	1

MOD 9026

Aluminium	Roh		
169026-009-92-00		457 - 463	1
Aluminium	Gebürstet		
OUTDOOR			
169026-009-92-18		457 - 463	1
Aluminium	Pulverbeschichtet RAL 7016, strukturiert		
OUTDOOR			
169026-009-92-33		457 - 463	1
Aluminium	Black Line		
OUTDOOR			
NEW	169026-009-92-82	457 - 463	1



POSTENGELENDERSYSTEME

EASY ALU

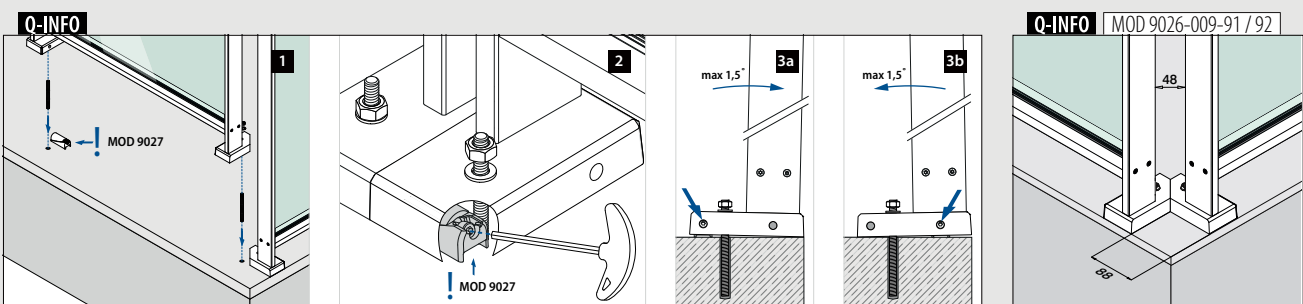



EASY ALU

Geländerpfosten, Seitenmontage

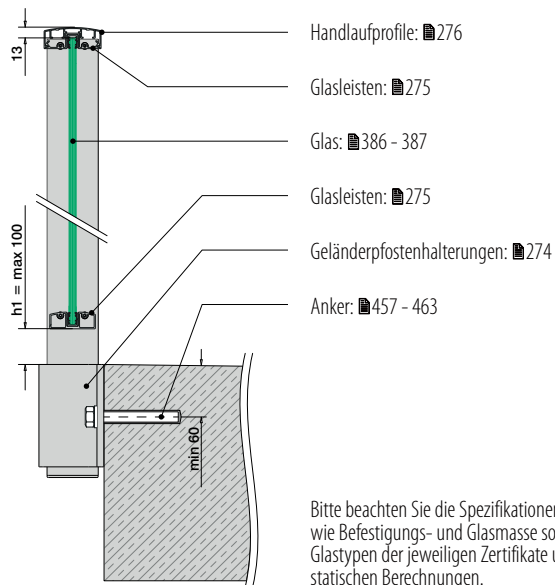

Bitte beachten Sie die Spezifikationen wie Befestigungs- und Glasmasse sowie Glastypeen der jeweiligen Zertifikate und statischen Berechnungen.

Berechnungen - Geländerpfosten, Seitenmontage

Geländerhöhe (H) + 140 mm = Höhe Geländerpfosten (Hp)

Geländerhöhe (H)	Höhe Geländerpfosten (Hp)
900 mm	1040 mm
1000 mm	1140 mm
1100 mm	1240 mm
1200 mm	1340 mm

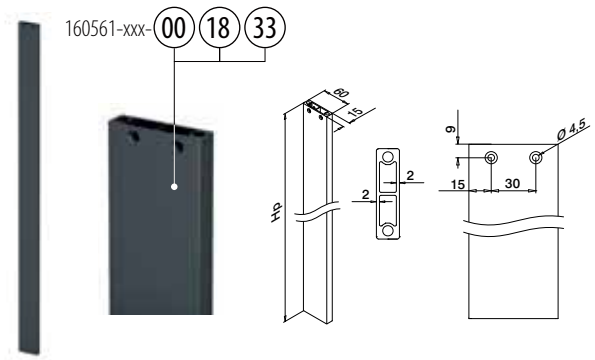

MOD 0561

Aluminium Roh	Hp	
160561-104-00	1040	1
160561-114-00	1140	1
160561-124-00	1240	1
160561-134-00	1340	1

Aluminium Gebürstet		
OUTDOOR		
160561-104-18	1040	1
160561-114-18	1140	1
160561-124-18	1240	1
160561-134-18	1340	1

Aluminium Pulverbeschichtet RAL 7016		
OUTDOOR		
160561-104-33	1040	1
160561-114-33	1140	1
160561-124-33	1240	1
160561-134-33	1340	1



POSTENGELENDERSYSTEME

EASY ALU

Q-INFO

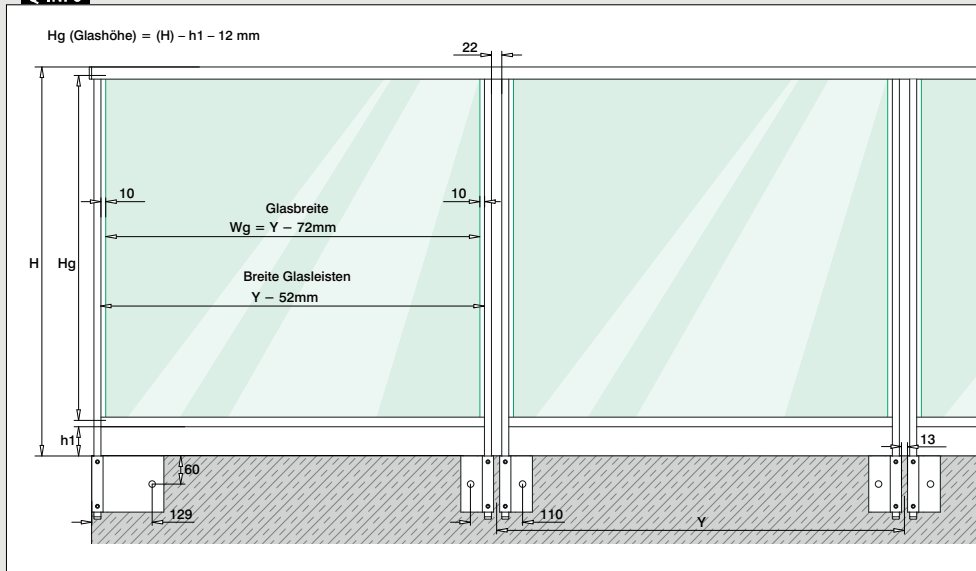

Q-INFO

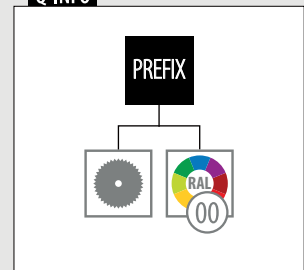

Geländerpfostenhalterungen, Seitenmontage

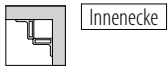

Innenecke



Links / rechts

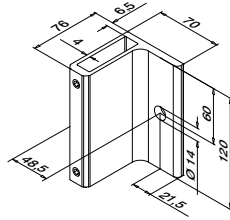

MOD 9028

Aluminium Roh		
169028-120-00-00	457 - 463	1
Aluminium Matt Silbereffekt		
OUTDOOR		
169028-120-00-08	457 - 463	1
Aluminium Pulverbeschichtet RAL 7016, strukturiert		
OUTDOOR		
169028-120-00-33	457 - 463	1

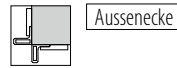

Aussenecke



Links / rechts

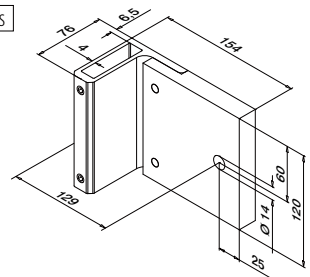

MOD 9028

Aluminium Roh		
169028-120-90-00	457 - 463	1
Aluminium Matt Silbereffekt		
OUTDOOR		
169028-120-90-08	457 - 463	1
Aluminium Pulverbeschichtet RAL 7016, strukturiert		
OUTDOOR		
169028-120-90-33	457 - 463	1



Endkappen für Pfosten, Seitenmontage



Unten

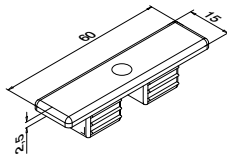

MOD 5743 - EASY HIT®

Kunststoff Aluminium RAL 9006	
OUTDOOR	
155743-36	2
Kunststoff Anthrazitgrau RAL 7016	
OUTDOOR	
155743-33	2



EASY ALU

PFOSTENGELÄNDERSYSTEME

Q-INFO MOD 9028

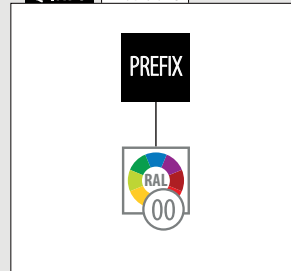

Q-INFO Kunststoff



Q-INFO MOD 5743 / 9028

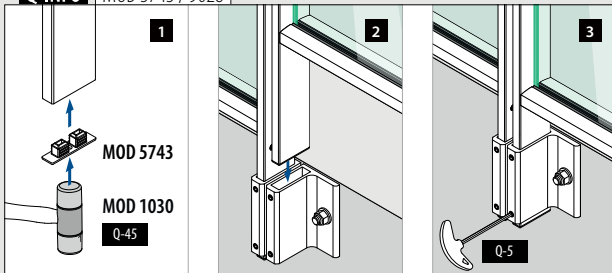

Q-INFO Aluminium



Q-INFO MOD 9028-120-00 / 9028-120-90

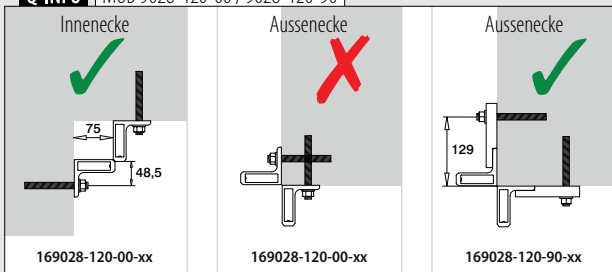

Q-INFO MOD 9028-120-90

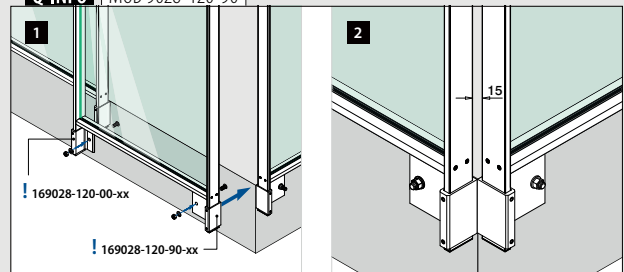

Glasleisten

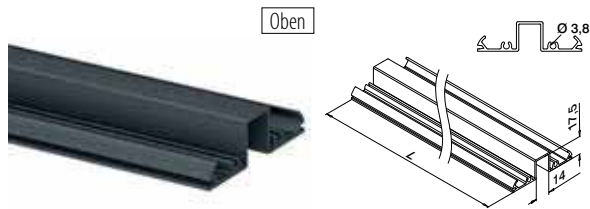

MOD 5951

Aluminium	Roh		
165951-050-00	QS-267	471	L = 5 m
Aluminium	Gebürstet		
OUTDOOR			
165951-050-18	QS-267	471	L = 5 m
Aluminium	Pulverbeschichtet RAL 7016, strukturiert		
OUTDOOR			
165951-050-33	QS-267	471	L = 5 m
Aluminium	Black Line		
OUTDOOR			
NEW	165951-050-82	QS-267	471 L = 5 m

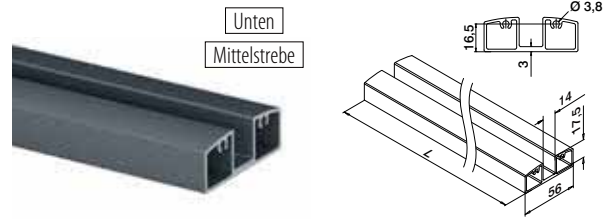

MOD 5952

Aluminium	Roh		
165952-050-00	QS-267	471	L = 5 m
Aluminium	Gebürstet		
OUTDOOR			
165952-050-18	QS-267	471	L = 5 m
Aluminium	Pulverbeschichtet RAL 7016, strukturiert		
OUTDOOR			
165952-050-33	QS-267	471	L = 5 m
Aluminium	Black Line		
OUTDOOR			
NEW	165952-050-82	QS-267	471 L = 5 m



Glass Wing Gummipprofile

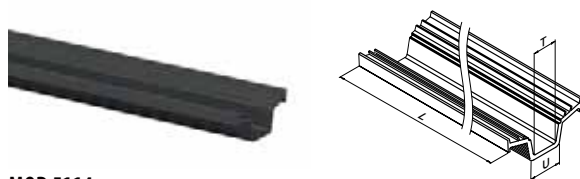

MOD 5114

Zubehör			
Für monolithisches Glas	U	T	
205114-050-08	14	8	L = 5 m
205114-050-10	14	10	L = 5 m
Für laminiertes Glas			
205114-050-08	14	8,76	L = 5 m
205114-050-10	14	9,52 - 10,76	L = 5 m

Internationaler Geschmacksmusterschutz

Adapter für Glasleisten

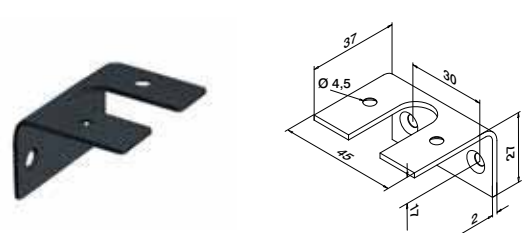

MOD 5960

Aluminium	Roh		
165960-00	QS-268	471	4
Aluminium	Gebürstet		
OUTDOOR			
165960-18	QS-268	471	4
Aluminium	Pulverbeschichtet RAL 7016, strukturiert		
OUTDOOR			
165960-33	QS-268	471	4
Aluminium	Black Line		
OUTDOOR			
NEW	165960-82	QS-268	471 4



Q-INFO | MOD 5952

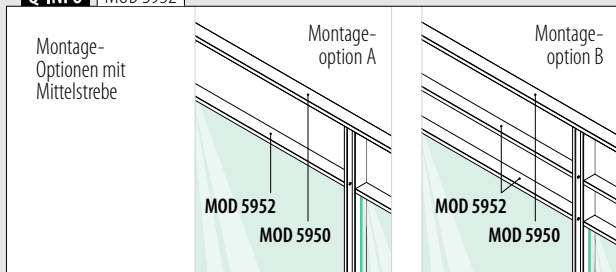

Q-INFO | MOD 5951 / 5952 / 5960

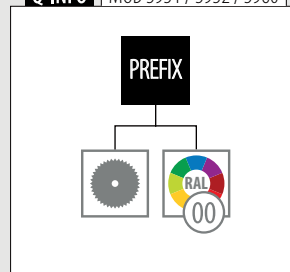

Q-INFO | MOD 5960



Handlaufprofile

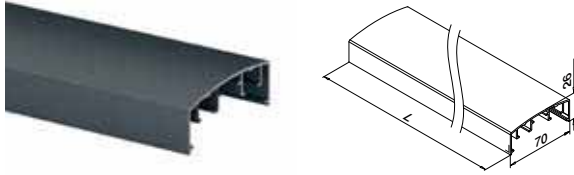

MOD 5950

Aluminium	Roh	
165950-050-00		L = 5 m
Aluminium	Gebürstet	
OUTDOOR		
165950-050-18		L = 5 m
Aluminium	Pulverbeschichtet RAL 7016, strukturiert	
OUTDOOR		
165950-050-33		L = 5 m
Aluminium	Black Line	
OUTDOOR		
NEW	165950-050-82	L = 5 m

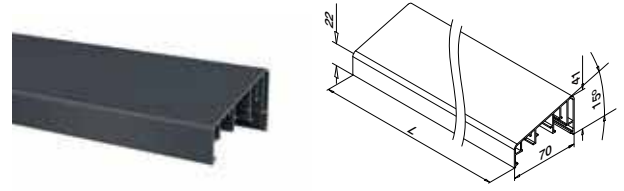

MOD 5953

Aluminium	Roh	
165953-050-00		L = 5 m
Aluminium	Gebürstet	
OUTDOOR		
165953-050-18		L = 5 m
Aluminium	Pulverbeschichtet RAL 7016, strukturiert	
OUTDOOR		
165953-050-33		L = 5 m
Aluminium	Black Line	
OUTDOOR		
165953-050-82		L = 5 m



Q-INFO Aluminium

00 Roh	18 Gebürstet, anodisiert	33 RAL 7016 Pulver- beschichtet	82 RAL 9005 Pulver- beschichtet
----------------------	---	--	--

Q-INFO

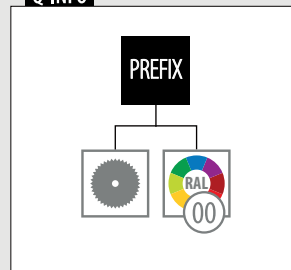

Q-INFO

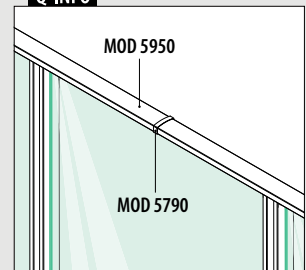

Abdeckkappen für Verbinder

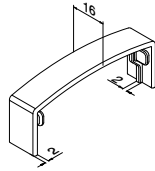

MOD 5790

Kunststoff	Weissaluminium RAL 9006
OUTDOOR	
155790-36	2
Kunststoff	Anthrazitgrau RAL 7016
OUTDOOR	
155790-33	2
Kunststoff	Schwarz RAL 9005
OUTDOOR	
NEW 155790-80	2

90° Ecke

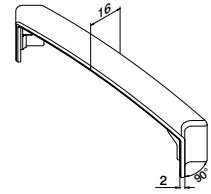

MOD 5314

Kunststoff	Weissaluminium RAL 9006
OUTDOOR	
155314-36	2
Kunststoff	Anthrazitgrau RAL 7016
OUTDOOR	
155314-33	2
Kunststoff	Schwarz RAL 9005
OUTDOOR	
NEW 155314-80	2

Verbinder

Justierbar

2x pro Ecke / Verbindung

0 - 90°

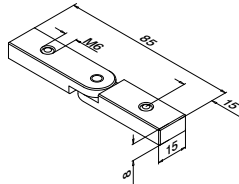

MOD 5313

Aluminium	Roh
165313	2



Q-INFO Kunststoff

36 RAL 9006



Weissaluminium, satiniert, glatt

33 RAL 7016

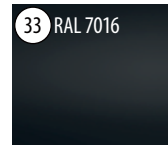

Anthrazitgrau, matt, glatt

80 RAL 9005



Schwarz, satiniert, strukturiert

Q-INFO MOD 5313 / 5314

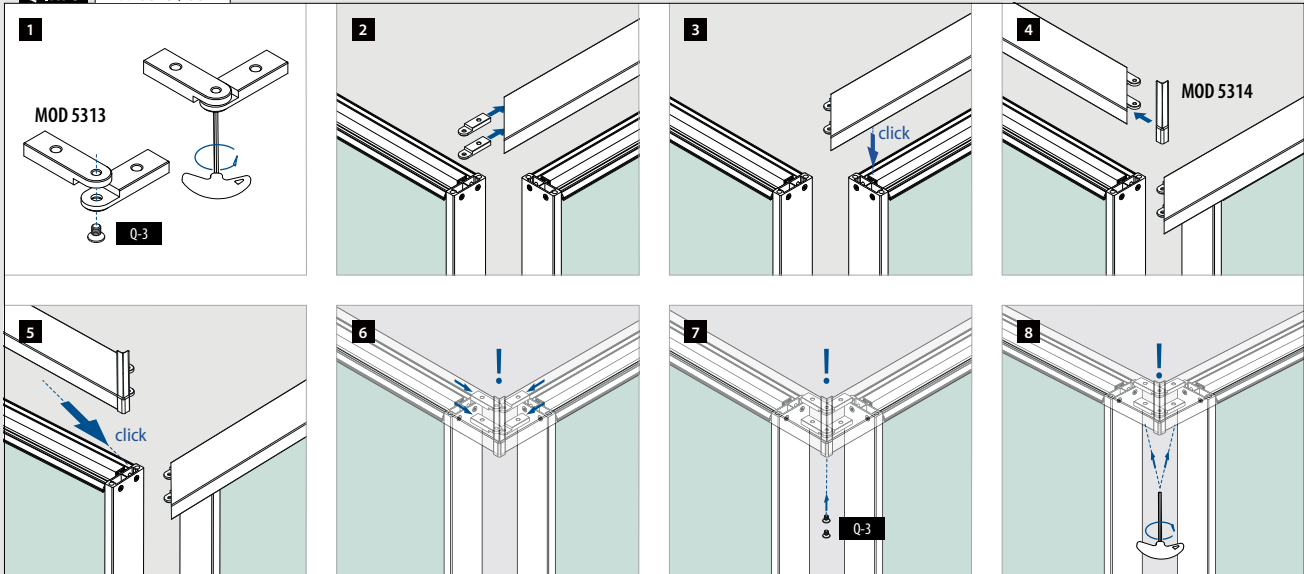

Q-INFO MOD 5313 / 5790

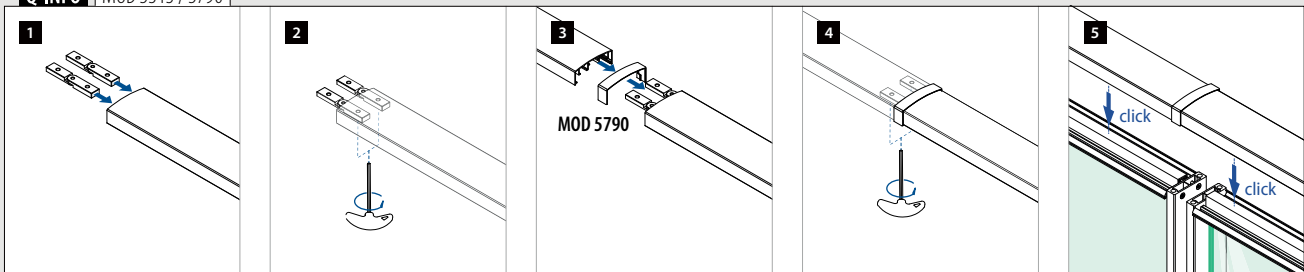

Endkappen für Handlaufprofile



MOD 5742 - EASY HIT®

Aluminium	Roh	
165742-00		2
Aluminium	Gebürstet	
OUTDOOR		
165742-18		2
Aluminium	Pulverbeschichtet RAL 7016, strukturiert	
OUTDOOR		
165742-33		2
Aluminium	Black Line	
OUTDOOR		
NEW	165742-82	2



Wandflansche

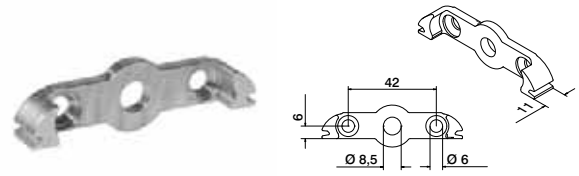

MOD 5505

Aluminium	Roh			
165505	QS-267 ■ 471 / QS-87 ■ 470	2		

Q-INFO MOD 5742

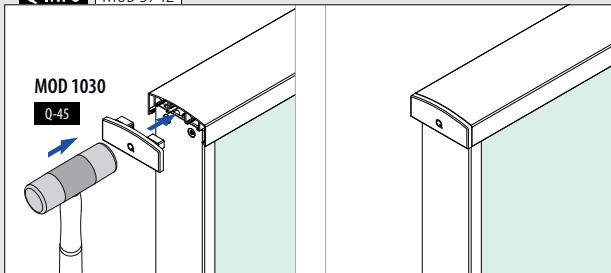

Q-INFO MOD 5505

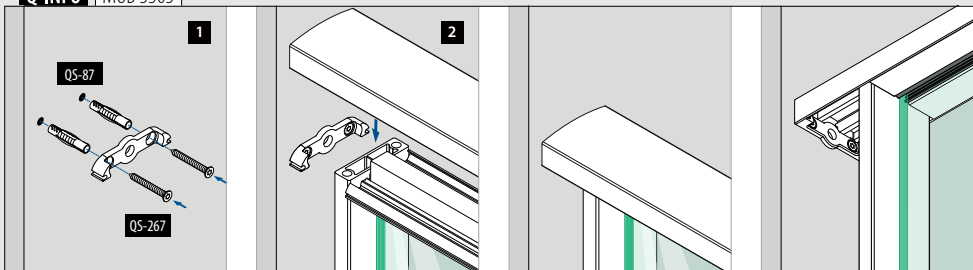

Q-INFO MOD 5742

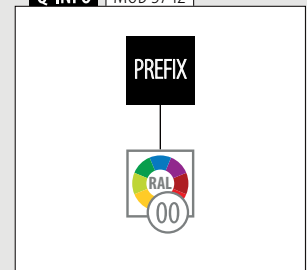

Endkappen für Handlaufprofile

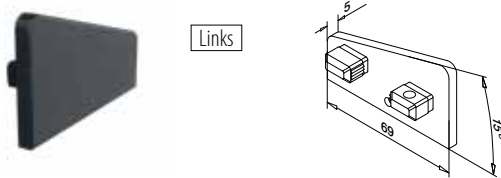

MOD 5744

Aluminium Roh	
165744-01-00	2
Aluminium Gebürstet	
OUTDOOR	
165744-01-18	2
Aluminium Pulverbeschichtet RAL 7016, strukturiert	
OUTDOOR	
165744-01-33	2
Aluminium Black Line	
OUTDOOR	
165744-01-82	2

NEW

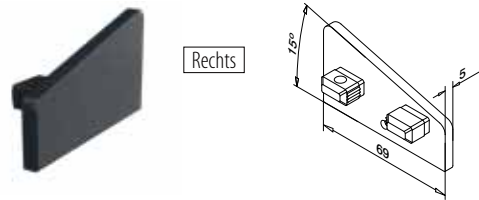

MOD 5744

Aluminium Roh	
165744-02-00	2
Aluminium Gebürstet	
OUTDOOR	
165744-02-18	2
Aluminium Pulverbeschichtet RAL 7016, strukturiert	
OUTDOOR	
165744-02-33	2
Aluminium Black Line	
OUTDOOR	
165744-02-82	2

NEW

Q-INFO Aluminium

00	18	33 RAL 7016	82 RAL 9005
Roh	Gebürstet, anodisiert	Pulverbeschichtet Anthrazitgrau, matt, strukturiert	Pulverbeschichtet Schwarz, matt, strukturiert

Q-INFO





Stabausfachung

Schaffen Sie mit der Stabausfachung für Easy Alu einen modernen französischen Balkon.
Auf Anfrage erhältlich.

Blechfüllung

Mit einer Blechfüllung verleihen Sie Pfostengeländern einen individuellen, ausdrucksstarken Look.
Auf Anfrage erhältlich.

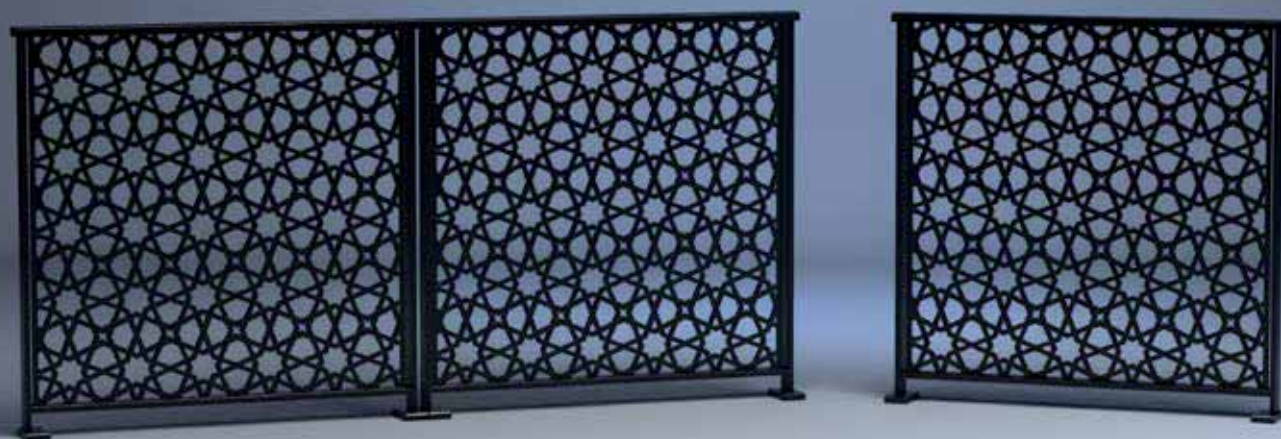

IHRE BESTELLOPTIONEN

Option

1 MONTAGEFERTIGE MODULE

WIR:

- sägen und bohren nach Ihren Angaben
- liefern die gewünschte Oberflächenausführung (gebürstet, roh oder pulverbeschichtet in der gewünschten RAL-Farbe)
- montieren die Module für Sie vor
- liefern Ihnen die baustellenfertigen Segmente exakt nach Ihren Anforderungen

SIE:

- platzieren die Geländermodule auf der Baustelle
- verankern die Module am Boden
- befestigen den Handlauf



Option

2 VORGEFERTIGTE EINZELKOMPONENTEN

WIR:

- sägen und bohren nach Ihren Angaben
- lassen die Komponenten, falls gewünscht, pulverbeschichten
- liefern Ihnen die Komponenten exakt nach Ihren Anforderungen

SIE:

- fertigen aus den Komponenten die Geländermodule
- platzieren die Module auf der Baustelle
- verankern diese am Boden
- befestigen den Handlauf



Option

3 STANDARD-EINZELKOMPONENTEN

WIR:

- liefern Ihnen die gewünschten Einzelkomponenten in der Standardausführung

SIE:

- sägen, bohren und, falls gewünscht, pulverbeschichten die Komponenten
- fertigen aus den Komponenten die Geländermodule
- platzieren die Module auf der Baustelle
- verankern diese am Boden
- befestigen den Handlauf





Finden Sie alle Informationen zu Square Line® 40x10 online:



<https://q-ne.ws/SquareLine41-23>

SQUARE LINE®

40x10

Handläufe

Handlaufstützen

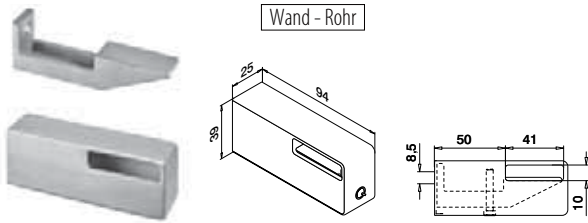

MOD 4134

V2A	304	Gebürstet			
INDOOR*		Für Rohr			
134134-041-12	40 x 10 x 1,5	QS-35	467 / QS-3	471	2
V2A	304	Black Line			
INDOOR*					
NEW	134134-041-82	40 x 10 x 1,5	QS-35	467 / QS-3	471
V4A	316	Gebürstet			
OUTDOOR					
SELL OUT	144134-041-12	40 x 10 x 1,5	QS-34	467 / QS-4	471



Internationaler Geschmacksmusterschutz

Handläufe

Rohre

Q-TUBE

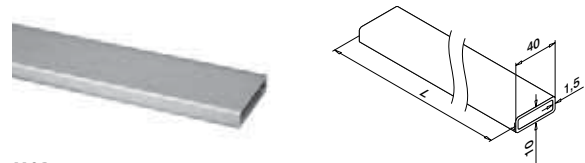

MOD 4900

V2A	304	Gebürstet			
INDOOR*					
134900-041-25-12	40 x 10 x 1,5				L = 2,5 m
134900-041-50-12	40 x 10 x 1,5				L = 5 m
V2A	304	Black Line			
INDOOR*					
NEW	134900-041-50-82	40 x 10 x 1,5			L = 5 m
V4A	316	Gebürstet			
OUTDOOR					
SELL OUT	144900-041-25-12	40 x 10 x 1,5			L = 2,5 m
SELL OUT	144900-041-50-12	40 x 10 x 1,5			L = 5 m



Q-INFO | MOD 4134 / 4900

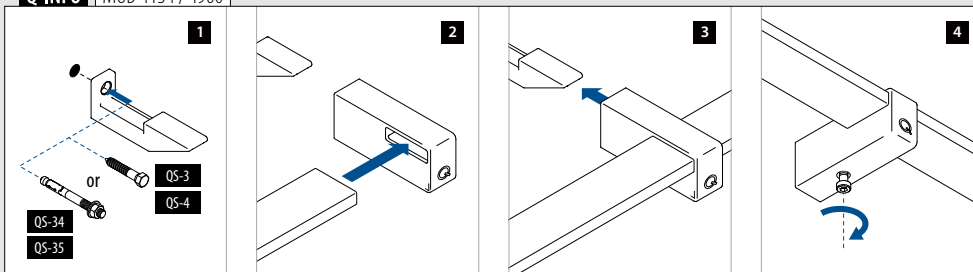

Q-INFO | MOD 4900

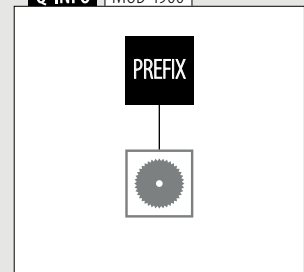

Verbinder

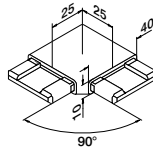
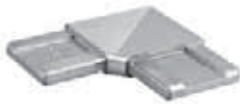

MOD 4301

V2A	304	Gebürstet		
	INDOOR*		Für Rohr <input type="checkbox"/>	
	134301-041-12		40 x 10 x 1,5	2
V2A	304	Black Line		
	INDOOR*			
NEW	134301-041-82		40 x 10 x 1,5	2
V4A	316	Gebürstet		
	OUTDOOR			
SELL OUT	144301-041-12		40 x 10 x 1,5	2

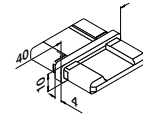

MOD 4790

V2A	304	Gebürstet		
	INDOOR*		Für Rohr <input type="checkbox"/>	
	134790-041-12		40 x 10 x 1,5	2
V2A	304	Black Line		
	INDOOR*			
NEW	134790-041-82		40 x 10 x 1,5	2
V4A	316	Gebürstet		
	OUTDOOR			
SELL OUT	144790-041-12		40 x 10 x 1,5	2



Verbinder

Justierbar



-70°
+70°

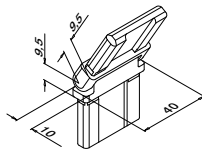

MOD 4312

V2A	304	Gebürstet		
	INDOOR*		Für Rohr <input type="checkbox"/>	
	134312-041-12		40 x 10 x 1,5	2
V4A	316	Gebürstet		
	OUTDOOR			
SELL OUT	144312-041-12		40 x 10 x 1,5	2



Endkappen

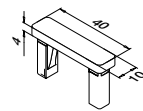

MOD 4732

V2A	304	Gebürstet		
	INDOOR*		Für Rohr <input type="checkbox"/>	
	134732-041-12		40 x 10 x 1,5	2
V2A	304	Black Line		
	INDOOR*			
NEW	134732-041-82		40 x 10 x 1,5	2
V4A	316	Gebürstet		
	OUTDOOR			
SELL OUT	144732-041-12		40 x 10 x 1,5	2



Q-INFO 304

12

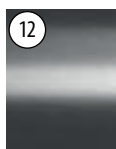

Gebürstet

82 RAL 9005

Pulver-
beschichtetSchwarz, matt,
strukturiert

* Auch für Aussenanwendung geeignet bei entsprechenden Bedingungen.



Nur solange der Vorrat reicht.



Finden Sie alle
Informationen zu
Square Line® 40x20 online:

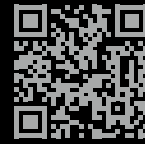

[https://q-ne.ws/
SquareLine42-23](https://q-ne.ws/SquareLine42-23)

SQUARE LINE® 40x20

SCHLICHTE UND
ELEGANTE HANDLÄUFE

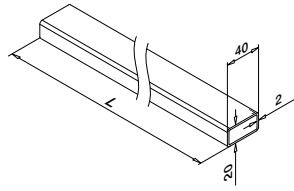

MOD 4900

V2A	304	Gebürstet		
INDOOR*			<input type="checkbox"/>	
134900-020-50-12	40 x 20 x 2,0			L = 5 m

V4A	316	Gebürstet		
OUTDOOR				
NEW 144900-020-50-12	40 x 20 x 2,0			L = 5 m

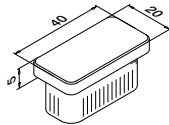

MOD 5728 - EASY HIT®

V2A	304	Gebürstet		
INDOOR*		Für Rohr	<input type="checkbox"/>	
135728-020-12	40 x 20 x 2,0			2

V4A	316	Gebürstet		
OUTDOOR				
NEW 145728-020-12	40 x 20 x 2,0			2

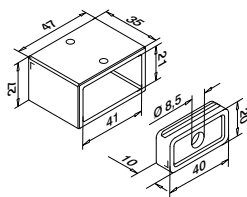

MOD 4504

V2A	304	Gebürstet		
INDOOR*		Für Rohr	<input type="checkbox"/>	
134504-020-12	40 x 20 x 2,0	QS-55 470 / QS-26 472		2

V4A	316	Gebürstet		
OUTDOOR				
144504-020-12	40 x 20 x 2,0	QS-55 470 / QS-27 472		2

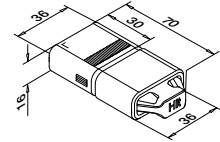

MOD 5794 - EASY HIT®

V4A	316	Roh		
OUTDOOR		Für Rohr	<input type="checkbox"/>	
145794-020	40 x 20 x 2,0			2

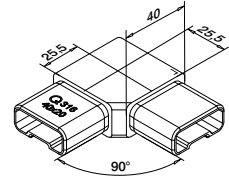

MOD 4301

V2A	304	Gebürstet		
INDOOR*		Für Rohr	<input type="checkbox"/>	
134301-020-12	40 x 20 x 2,0			2

V4A	316	Gebürstet		
OUTDOOR				
144301-020-12	40 x 20 x 2,0			2



0-70°

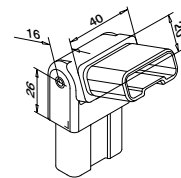

MOD 4312

V2A	304	Gebürstet		
INDOOR*		Für Rohr	<input type="checkbox"/>	
134312-020-12	40 x 20 x 2,0			2

V4A	316	Gebürstet		
OUTDOOR				
144312-020-12	40 x 20 x 2,0			2



Q-INFO MOD 4900

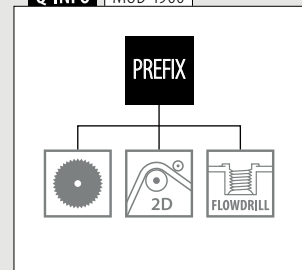

* Auch für Aussenanwendung geeignet bei entsprechenden Bedingungen.

Handläufe
Handlaufstützen Justierbar **Pfostenmontage**

Für flaches Rohr

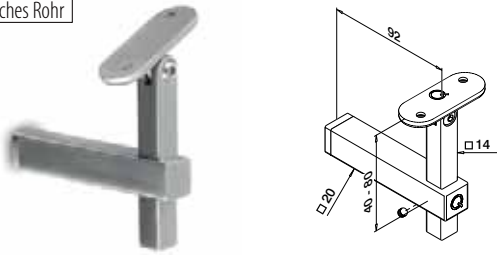

MOD 4133

V2A	304	Gebürstet				
INDOOR*						
SELL OUT	134133-000-12	QS-55	470 / QS-21	472 / QS-12	472	2



Handläufe
Handlaufstützen Justierbar **Wandmontage**

Für flaches Rohr

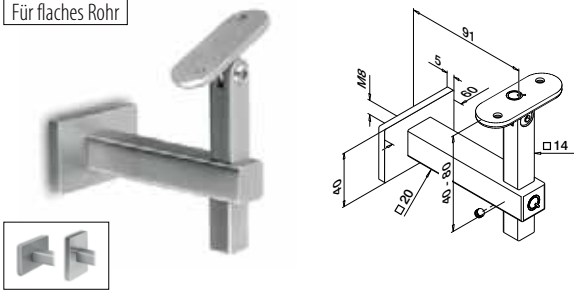

MOD 4145

V2A	304	Gebürstet			
INDOOR*					
SELL OUT	134145-000-12	QS-1	471 / QS-12	472	2

V4A	316	Gebürstet			
OUTDOOR					
SELL OUT	144145-000-12	QS-2	471 / QS-13	472	2



Handläufe
Handlaufstützen Justierbar **Glasmontage**

Für flaches Rohr

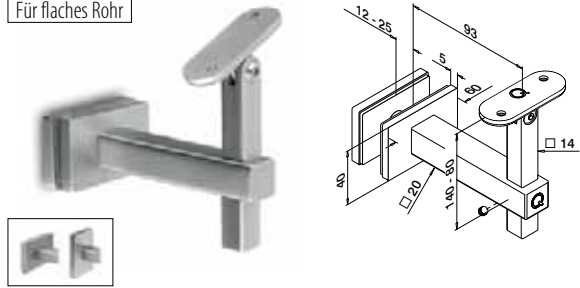

MOD 4155

V2A	304	Gebürstet		
INDOOR*				
SELL OUT	134155-000-12	QS-12	472	2



Handläufe
Handlaufstützen **Wandmontage**

Für flaches Rohr

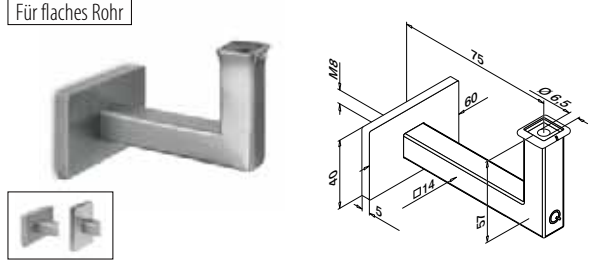

MOD 4121

V2A	304	Gebürstet			
INDOOR*					
SELL OUT	134121-000-12	QS-1	471 / QS-54	472	2

V4A	316	Gebürstet			
OUTDOOR					
SELL OUT	144121-000-12	QS-2	471 / QS-70	472	2



* Auch für Aussenanwendung geeignet bei entsprechenden Bedingungen.

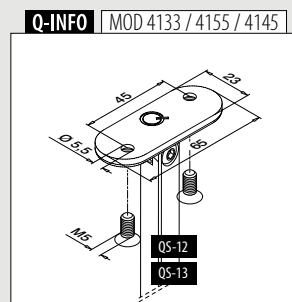
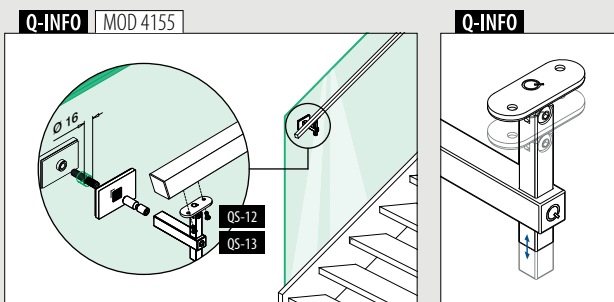

Für flaches Rohr

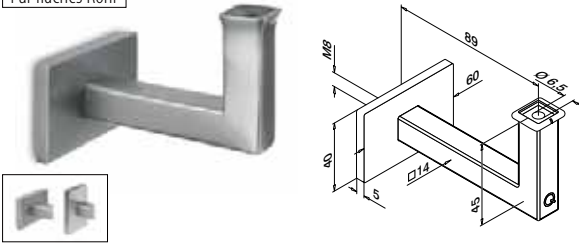

MOD 4111

V2A	304	Gebürstet		
INDOOR*				
	134111-000-12	QS-1	471 / QS-54	472
				2
V4A	316	Gebürstet		
OUTDOOR				
NEW	144111-000-12	QS-2	471 / QS-70	472
				2



Für flaches Rohr

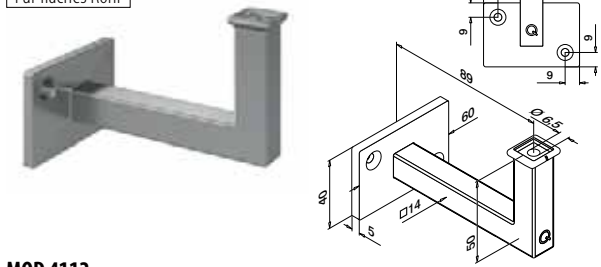

MOD 4112

V2A	304	Gebürstet		
INDOOR*				
	134112-000-12	QS-5	471 / QS-54	472
				2
V4A	316	Gebürstet		
OUTDOOR				
NEW	144112-000-12	QS-6	471 / QS-70	472
				2



Q-INFO MOD 4111

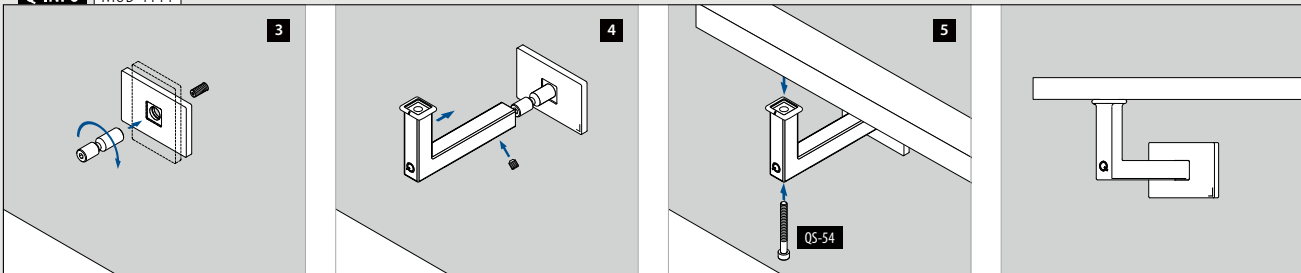

Q-INFO MOD 4111 / 4112

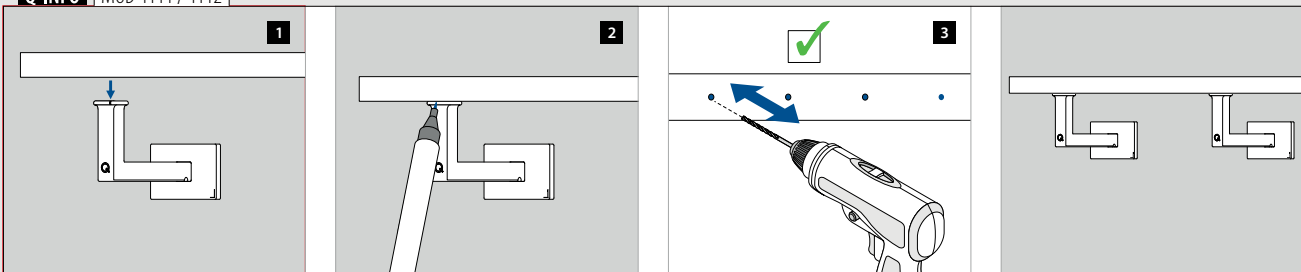



- Beanspruchung:** Leicht und mittel
Verwendung: Innen- und Außenbereich
Montage: Boden-, In-Boden- und Seitenmontage
Anwendung: Balkone, Galerien, Wege, Abtrennungen, Treppen und Französische Balkone
Material: Edelstahl V2A oder V4A (gebürstet oder pulverbeschichtet RAL 9005 schwarz)

Finden Sie alle Informationen zu Square Line® 40x40 online:



<https://q-ne.ws/SquareLine44-23>

SQUARE LINE® 40x40



Für einen geradlinigen, modernen Look

Square Line® 40x40 stellt eindrucksvoll unter Beweis, dass gutes Design nicht kompliziert sein muss. Mit seinen klaren Linien und Elementen aus Edelstahl schaffen Sie elegante, moderne Geländer und Treppengeländer. Möchten Sie runde Formen integrieren? Kein Problem! Square Line ist ein vollmodulares System, das Sie beliebig mit Komponenten aus anderen Q-railing Pfostengeländersystemen kombinieren können.

International getestet/berechnet/zertifiziert:



- 1 Dieses System bietet eine grosse Auswahl an Füllungen, darunter Glas, Stäbe, Netze und Drahtseile.
- 2 Die Handläufe können mit einer LED-Beleuchtung versehen werden.
- 3 Schaffen Sie dank des Industriedesigns einen modernen Look.



SQUARE LINE® 40x40 FÜLLUNGEN

Glas

- Glasrahmenrohr
- Glasklemmen
- Glasadapter
- Glashalter



▣ 386 - 390

Stab und Rohr

- Horizontale Geländerfüllung
- Vertikale Geländerfüllung



▣ 391 - 403

Drahtseil

- Fast Fix Ø 3,2 mm
- Fast Fix Ø 4,0 mm
- Easy Fix Ø 3,2 mm
- Easy Fix Ø 6,0 mm

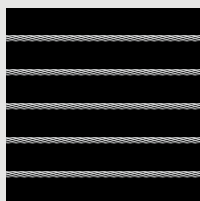

▣ 404 - 411

Netz

- Easy Q-web

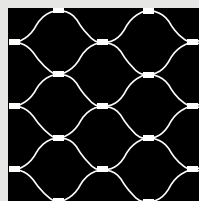

▣ 412 - 415

Blech

- Blechadapter

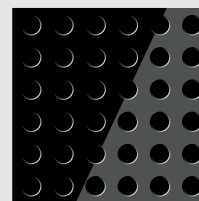

▣ 416 - 419

Geländerpfosten

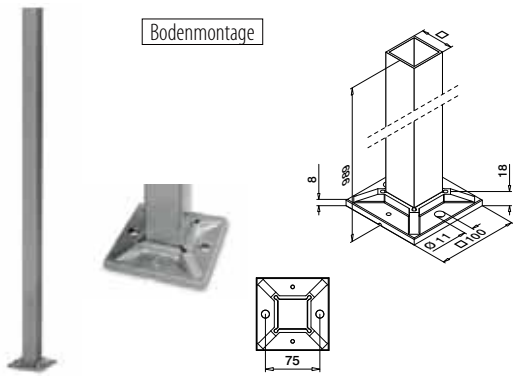

MOD 4921

V2A	304	Gebürstet		
	INDOOR*			
134921-040-12	40 x 40 x 2,0	Q5-59	467	1

V4A	316	Gebürstet		
	OUTDOOR			
144921-040-12	40 x 40 x 2,0	Q5-58	467	1



Geländerpfostenrohre

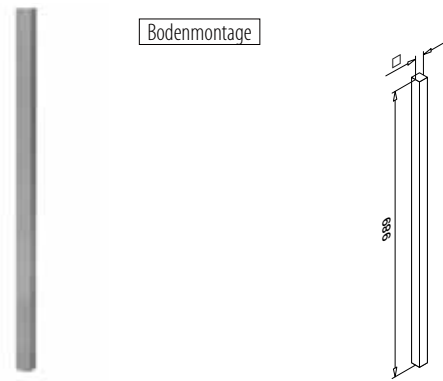

MOD 4901

V2A	304	Gebürstet		
	INDOOR*			
134901-040-12	40 x 40 x 2,0			1

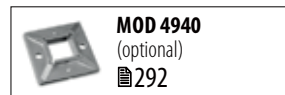

Abdeckkappen



MOD 4511

V2A	304	Gebürstet		
	INDOOR*		H	
134511-040-12	108		25	2

V4A	316	Gebürstet		
	OUTDOOR			
144511-040-12	108		25	2

Bodenflansche

Für Treppen

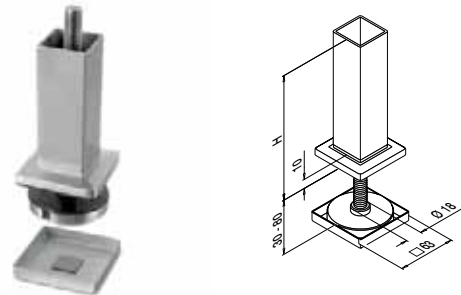

MOD 4546

V2A	304	Gebürstet		
	INDOOR*	Für Rohr		H
134546-040	40 x 40 x 2,0			100



Q-INFO | MOD 4921 / 4901 / 4546

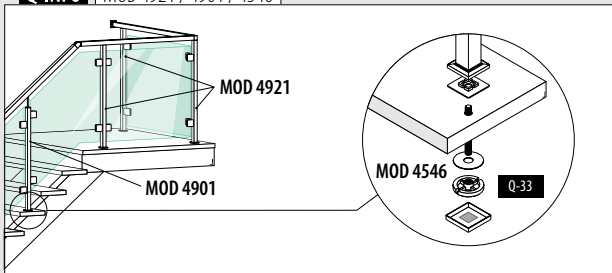

Q-INFO | MOD 4921 / 4901

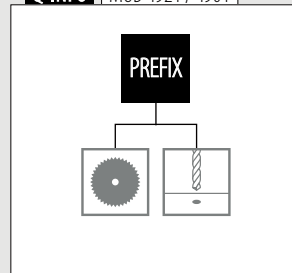

Q-INFO | MOD 4546 / 4901

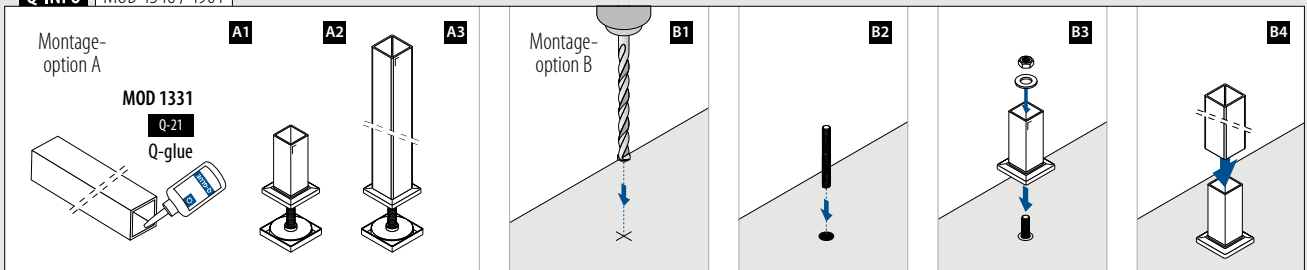

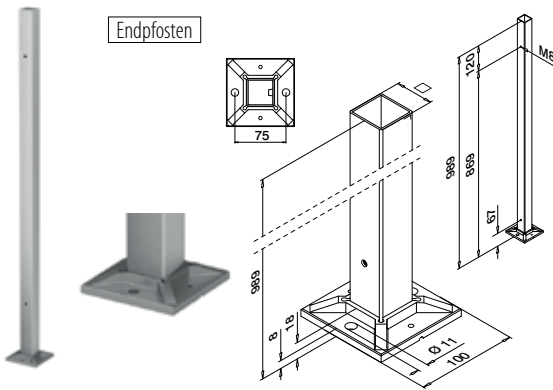

Endpfosten

MOD 4972

V2A	304	Gebürstet			
INDOOR*					
134972-040-01-12	40 x 40 x 2,0	QS-59	467	1	

V2A	304	Black Line			
INDOOR*					
NEW 134972-040-01-82	40 x 40 x 2,0	QS-59	467	1	

V4A	316	Gebürstet			
OUTDOOR					
144972-040-01-12	40 x 40 x 2,0	QS-58	467	1	

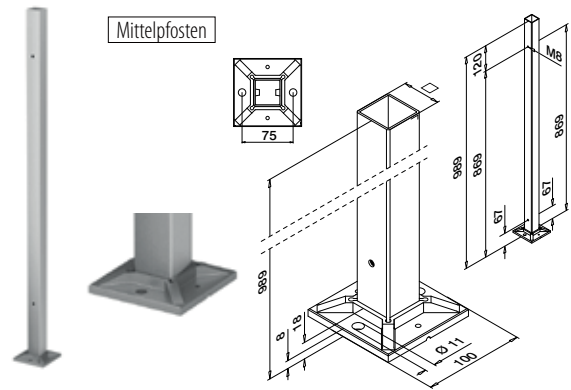

Mittelpfosten

MOD 4972

V2A	304	Gebürstet			
INDOOR*					
134972-040-02-12	40 x 40 x 2,0	QS-59	467	1	

V4A	316	Gebürstet			
OUTDOOR					
144972-040-02-12	40 x 40 x 2,0	QS-58	467	1	

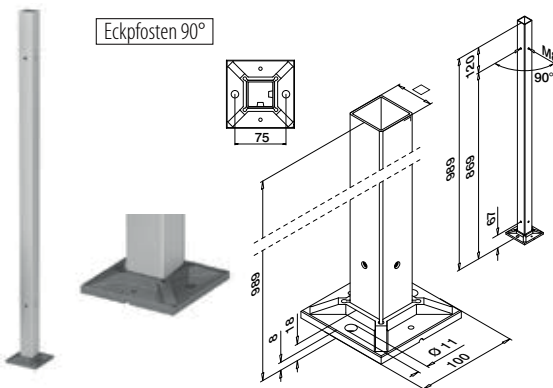

Eckpfosten 90°

MOD 4972

V2A	304	Gebürstet			
INDOOR*					
134972-040-90-12	40 x 40 x 2,0	QS-59	467	1	

V4A	316	Gebürstet			
OUTDOOR					
144972-040-90-12	40 x 40 x 2,0	QS-58	467	1	



Abdeckkappen



Bodenmontage

MOD 4511

V2A	304	Gebürstet			
INDOOR*					
134511-040-12	108	H	25	2	

V2A	304	Black Line			
INDOOR*					
NEW 134511-040-82	108	25	2		

V4A	316	Gebürstet			
OUTDOOR					
144511-040-12	108	25	2		

* Auch für Aussenanwendung geeignet bei entsprechenden Bedingungen.

Q-INFO

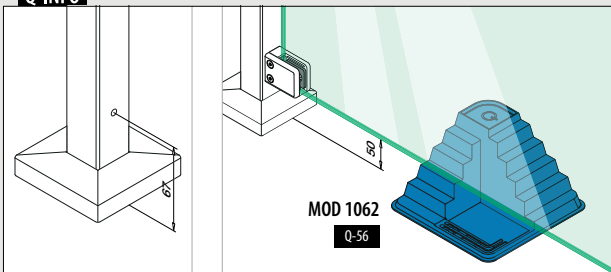

MOD 1062
Q-56

Q-INFO MOD 4972

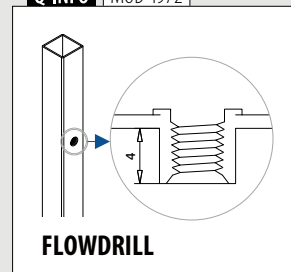

FLOWDRILL

Q-INFO MOD 4972



399

Stab- und Rohrfüllungen - rechteckig

Q-INFO 304



12

Gebürstet

82 RAL 9005

Pulverbeschichtet

Schwarz, matt, strukturiert

Geländerpfosten

Bodenflansche

Neigung einstellbar

Für Aufsteckrohre

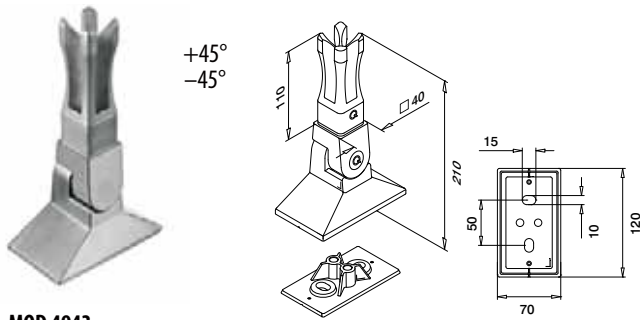

MOD 4943

V2A	304	Gebürstet			
	INDOOR*	Für Rohr <input type="checkbox"/>			
SELL OUT	134943-040-12	40 x 40 x 2,0	QS-63	464	1
V4A	316	Gebürstet			
	OUTDOOR				
	144943-040-12	40 x 40 x 2,0	QS-62	464	1



Internationaler Geschmacksmusterschutz

Geländerpfosten

Bodenflansche

Für Aufsteckrohre

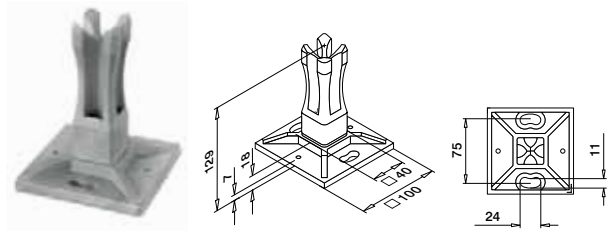

MOD 4942

V2A	304	Gebürstet			
	INDOOR*	Für Rohr <input type="checkbox"/>			
SELL OUT	134942-040	40 x 40 x 2,0	QS-59	467	2
V4A	316	Gebürstet			
	OUTDOOR				
	144942-040	40 x 40 x 2,0	QS-58	467	2



Internationaler Geschmacksmusterschutz

Geländerpfosten

Abdeckkappen

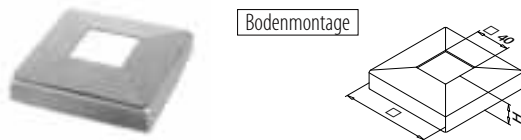

MOD 4511

V2A	304	Gebürstet			
	INDOOR*	<input type="checkbox"/>	H		
	134511-040-12	108	25		2
V4A	316	Gebürstet			
	OUTDOOR				
	144511-040-12	108	25		2

Geländerpfosten

Bodenflansche für Geländerpfosten

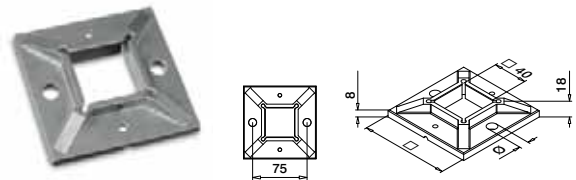

MOD 4940

V2A	304	Roh			
	INDOOR*	<input type="checkbox"/>	Ø		
	134940-040	100	11	QS-59	467
V4A	316	Roh			
	OUTDOOR				
	144940-040	100	11	QS-58	467

Q-INFO MOD 4942 / 4901 / 4511

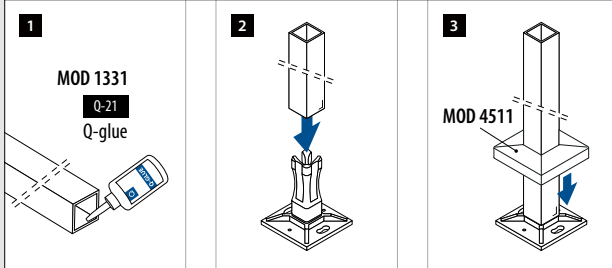

* Auch für Aussenanwendung geeignet bei entsprechenden Bedingungen.

SELL OUT Nur solange der Vorrat reicht.

Q-INFO MOD 4943

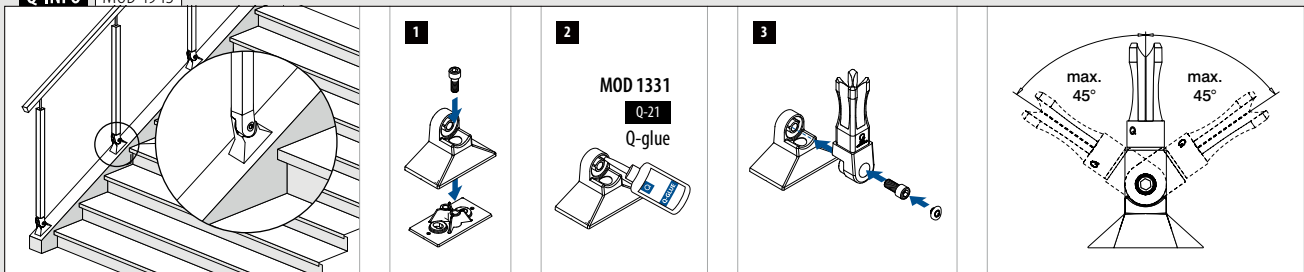

Geländerpfostenhalterungen

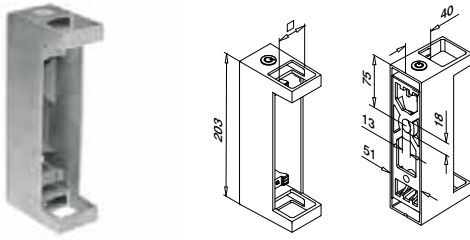

MOD 4558

V2A	304	Gebürstet			
	INDOOR*	<input type="checkbox"/>			
	134558-040-12	40 x 40	QS-63	464	1
V4A	316	Gebürstet			
	OUTDOOR				
	144558-040-12	40 x 40	QS-62	464	1

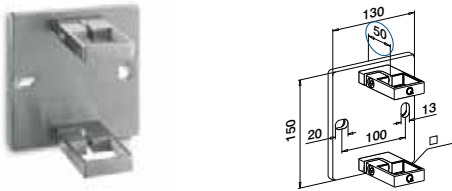

MOD 4551

V2A	304	Gebürstet			
	INDOOR*	<input type="checkbox"/>			
	134551-040-12	40 x 40	QS-33	464	1



MOD 0554

V2A	304	Gebürstet			
	INDOOR*	<input type="checkbox"/>	Für Rohr	<input type="checkbox"/>	
SELL OUT	130554-040-12	40 x 40			2
V4A	316	Gebürstet			
	OUTDOOR				
	140554-040-12	40 x 40			2

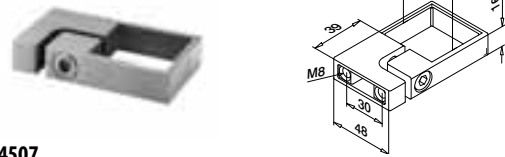

MOD 4507

V2A	304	Gebürstet			
	INDOOR*	<input type="checkbox"/>			
	134507-040-12	40 x 40			2
V4A	316	Gebürstet			
	OUTDOOR				
NEW	144507-040-12	40 x 40			2

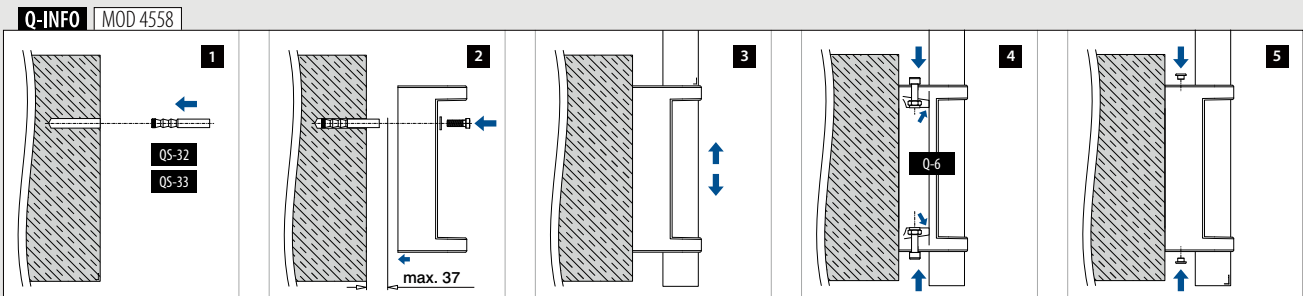
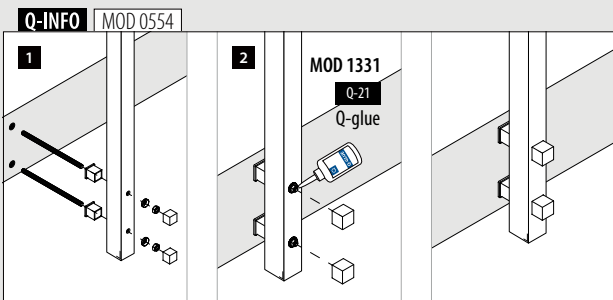

Für flaches Rohr

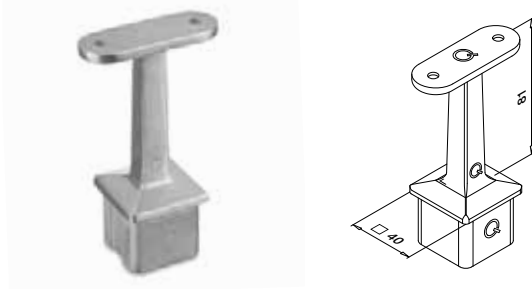

MOD 4710

V2A	304	Gebürstet	INDOOR*	Für Rohr □	Ø	40 x 40 x 2,0	QS-12	472	2
			134710-000-00-12						
V2A	304	Black Line	INDOOR*						
			134710-000-00-82	40 x 40 x 2,0	QS-12	472	2		
V4A	316	Gebürstet	OUTDOOR						
			144710-000-00-12	40 x 40 x 2,0	QS-13	472	2		



Für flaches Rohr zu rundem Rohr

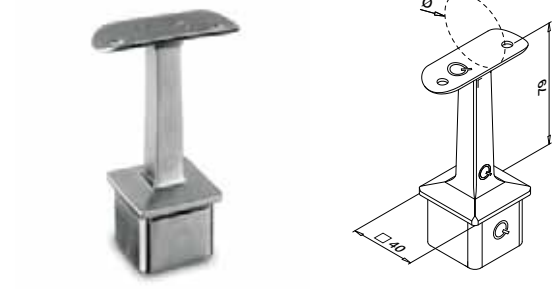

MOD 4710

V2A	304	Gebürstet	INDOOR*	Ø	Für Rohr □	40 x 40 x 2,0	QS-10	472	2
			134710-042-00-12	42,4					
SELL OUT			134710-048-00-12	48,3	40 x 40 x 2,0	QS-10	472	2	
V4A	316	Gebürstet	OUTDOOR						
			144710-042-00-12	42,4	40 x 40 x 2,0	QS-11	472	2	
SELL OUT			144710-048-00-12	48,3	40 x 40 x 2,0	QS-11	472	2	



Für flaches Rohr

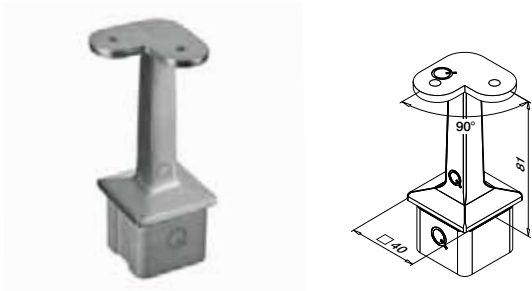

MOD 4710

V2A	304	Gebürstet	INDOOR*	Für Rohr □	Ø	40 x 40 x 2,0	QS-12	472	2
			134710-000-90-12						
V4A	316	Gebürstet	OUTDOOR						
			144710-000-90-12	40 x 40 x 2,0	QS-13	472	2		



Für flaches Rohr zu rundem Rohr

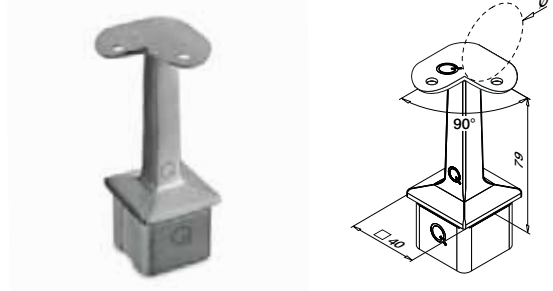

MOD 4710

V2A	304	Gebürstet	INDOOR*	Ø	Für Rohr □	40 x 40 x 2,0	QS-10	472	2
			134710-042-90-12	42,4					
V4A	316	Gebürstet	OUTDOOR						
			144710-042-90-12	42,4	40 x 40 x 2,0	QS-11	472	2	



Q-INFO | MOD 4710-000-00 / 4710-04x-00

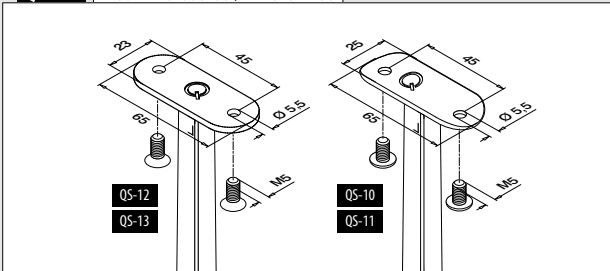

Q-INFO | 304

12	82 RAL 9005
Gebürstet	Pulverbeschichtet
	Schwarz, matt, strukturiert

Q-INFO | MOD 4710-000-90 / 4710-042-90

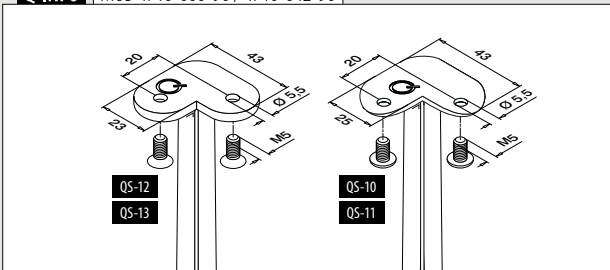

Q-INFO | MOD 4710-000-90

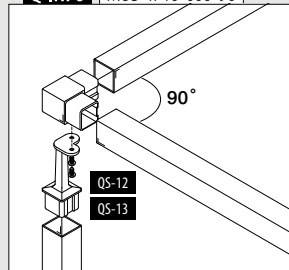

Q-INFO | MOD 4710-042-90

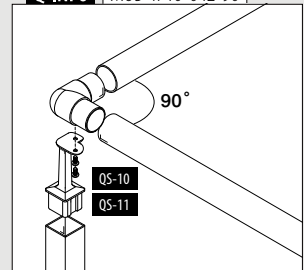

Für flaches Rohr

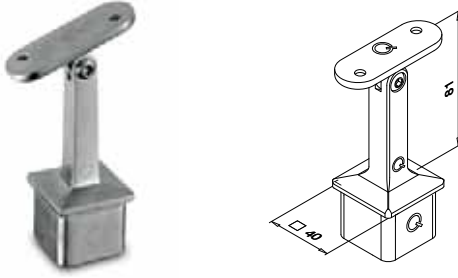

MOD 4718

V2A	304	Gebürstet			
	INDOOR*		Für Rohr □		
	134718-000-12		40 x 40 x 2,0	QS-12	472 2
V4A	316	Gebürstet			
	OUTDOOR				
	144718-000-12		40 x 40 x 2,0	QS-13	472 2



Für flaches Rohr zu rundem Rohr

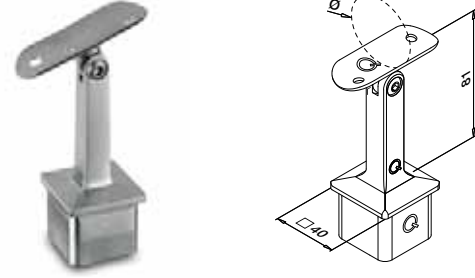

MOD 4718

V2A	304	Gebürstet			
	INDOOR*		Ø	Für Rohr □	
	134718-042-12		42,4	40 x 40 x 2,0	QS-10
SELL OUT	134718-048-12		48,3	40 x 40 x 2,0	QS-10
V4A	316	Gebürstet			
	OUTDOOR				
	144718-042-12		42,4	40 x 40 x 2,0	QS-11



Q-INFO

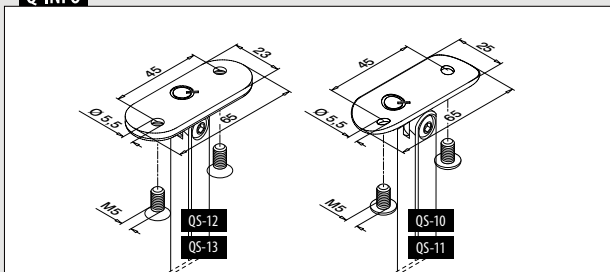

* Auch für Aussenanwendung geeignet bei entsprechenden Bedingungen.

SELL OUT Nur solange der Vorrat reicht.

Für flaches Rohr

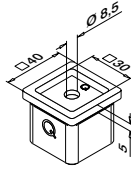

MOD 4727

V2A	304	Gebürstet			
	INDOOR*	Für Rohr	<input type="checkbox"/>		
	134727-12	40 x 40 x 2,0	QS-26	472	2
V4A	316	Gebürstet			
	OUTDOOR				
NEW	144727-12	40 x 40 x 2,0	QS-27	472	2

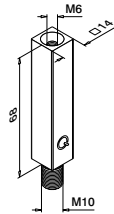

MOD 4811

V2A	304	Gebürstet			
	INDOOR*		<input type="checkbox"/>		
	134811		QS-48	472	2

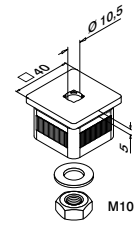
MOD 1810
337MOD 1801
337MOD 1802
337

MOD 4733- EASY HIT®

V2A	304	Gebürstet			
	INDOOR*	Für Rohr	<input type="checkbox"/>		
	134733	40 x 40 x 2,0			2



Q-INFO | MOD 4727

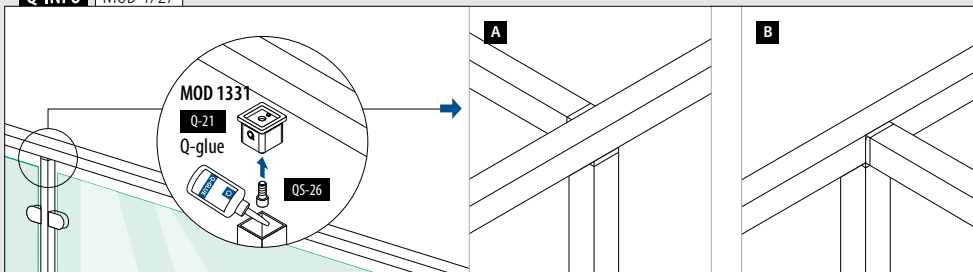

Q-INFO | MOD 4733 / 4811

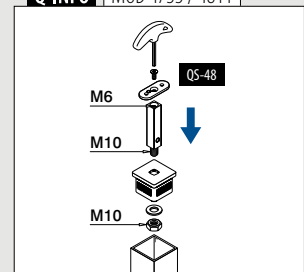

Für flaches Rohr



MOD 4133

V2A	304	Gebürstet		
INDOOR*				
SELL OUT	134133-000-12	QS-55 470 / QS-21 472 / QS-12 472		2

Für flaches Rohr
zu rundem Rohr

MOD 4133

V2A	304	Gebürstet		
INDOOR*				
SELL OUT	134133-042-12	42,4 QS-55 470 / QS-21 472 / QS-10 472		2

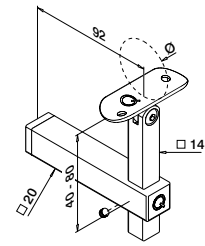

Für flaches Rohr



MOD 4155

V2A	304	Gebürstet		
INDOOR*				
SELL OUT	134155-000-12	QS-12 472		2

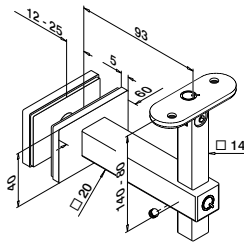

SELL OUT Nur solange der Vorrat reicht.

* Auch für Aussenanwendung geeignet bei entsprechenden Bedingungen.

Q-INFO

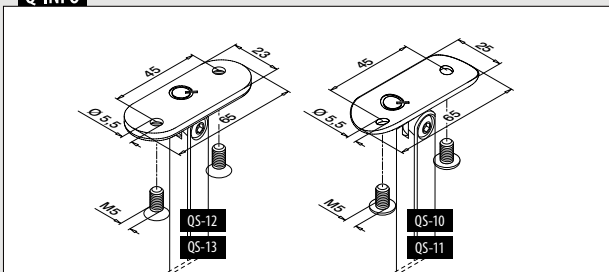

Q-INFO MOD 4155

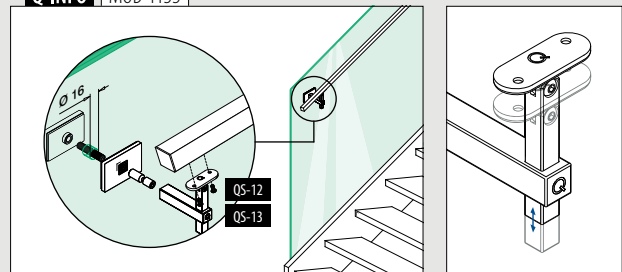

Für flaches Rohr

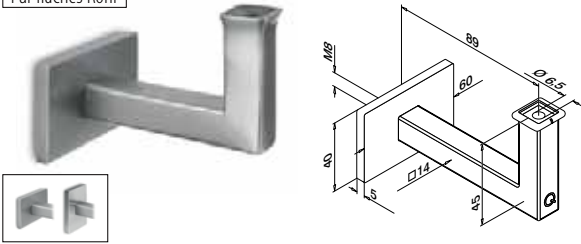

MOD 4111

V2A	304	Gebürstet		
INDOOR*				
134111-000-12	QS-1		471 / QS-54	
			472	2

V4A	316	Gebürstet		
OUTDOOR				
144111-000-12	QS-2		471 / QS-70	
			472	2



Für rundes Rohr

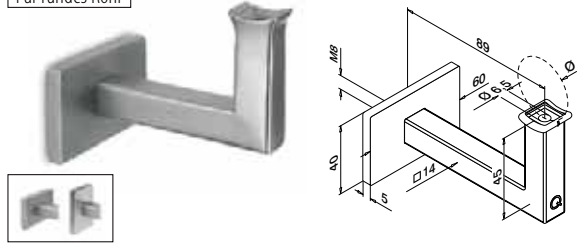

MOD 4111

V2A	304	Gebürstet		
INDOOR*				
134111-042-12	42,4	QS-1		471 / QS-54
				472
				2



Q-INFO | MOD 4111-042

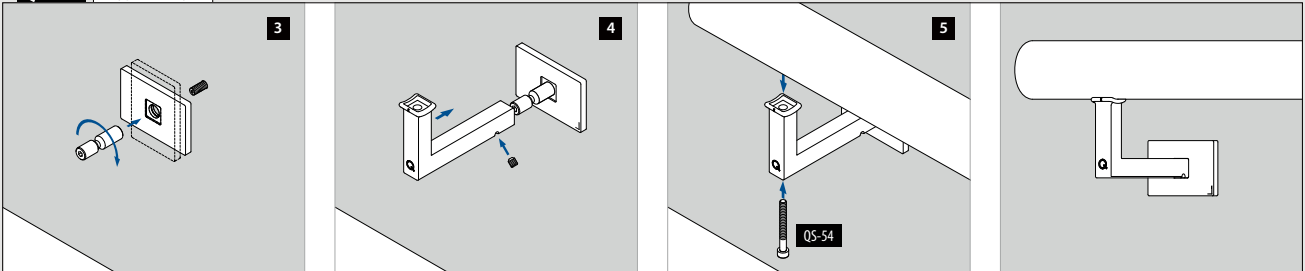

Q-INFO | MOD 4111-042

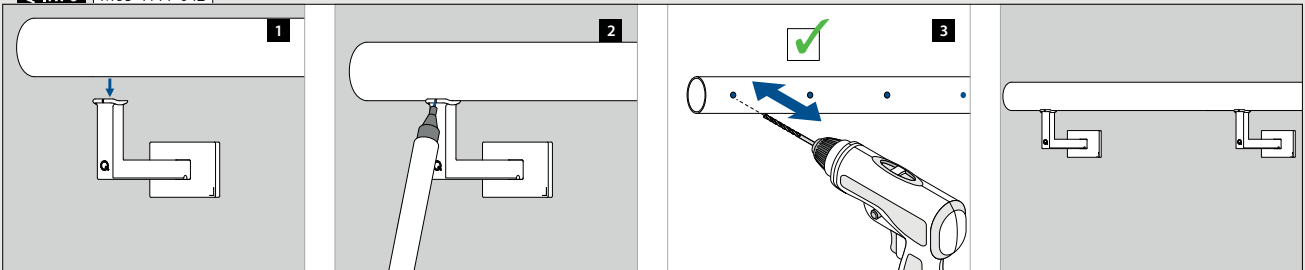

Für flaches Rohr

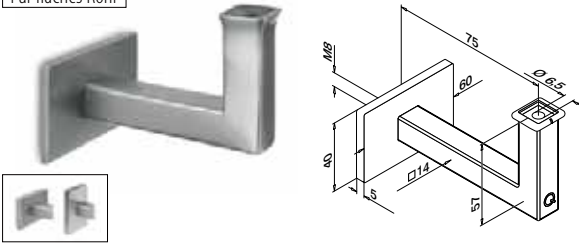

MOD 4121

V2A	304	Gebürstet		
INDOOR*				
134121-000-12	QS-1	471 / QS-54	472	2

V4A	316	Gebürstet		
OUTDOOR				
144121-000-12	QS-2	471 / QS-70	472	2



Für flaches Rohr

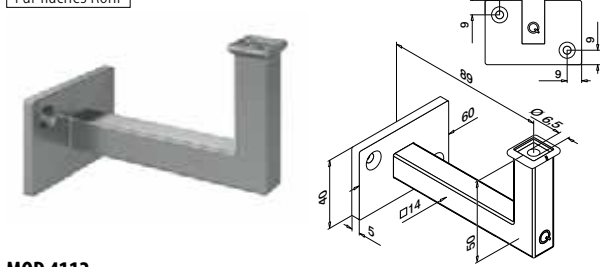

MOD 4112

V2A	304	Gebürstet		
INDOOR*				
134112-000-12	QS-5	471 / QS-54	472	2

V4A	316	Gebürstet		
OUTDOOR				
NEW 144112-000-12	QS-6	471 / QS-70	472	2



Für flaches Rohr

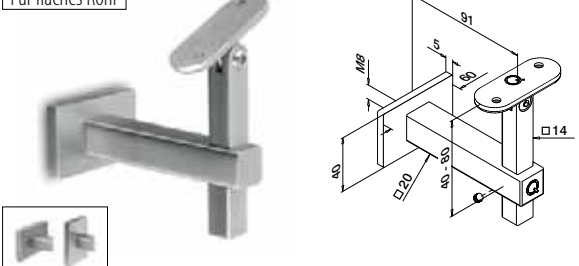

MOD 4145

V2A	304	Gebürstet		
INDOOR*				
134145-000-12	QS-1	471 / QS-12	472	2

V4A	316	Gebürstet		
OUTDOOR				
SELL OUT 144145-000-12	QS-2	471 / QS-13	472	2



Für rundes Rohr

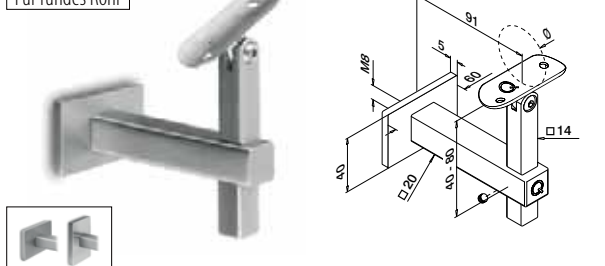

MOD 4145

V2A	304	Gebürstet		
INDOOR*				
134145-042-12	42,4	QS-1	471 / QS-10	472
				2



Q-INFO MOD 4145

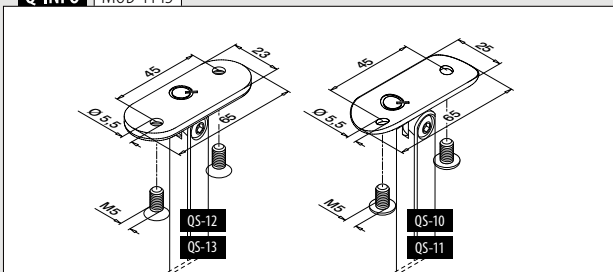

* Auch für Aussenanwendung geeignet bei entsprechenden Bedingungen.

SELL OUT Nur solange der Vorrat reicht.

Endkappen

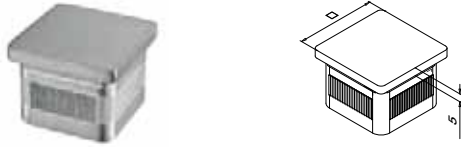

MOD 5728 - EASY HIT®

V2A	304	Gebürstet		
INDOOR*		Für Rohr □		
135728-040-12	40 x 40 x 2,0		2	
V2A	304	Black Line		
INDOOR*				
NEW 135728-040-82	40 x 40 x 2,0		2	
V4A	316	Gebürstet		
OUTDOOR				
145728-040-12	40 x 40 x 2,0		2	



Rohre

Q-TUBE

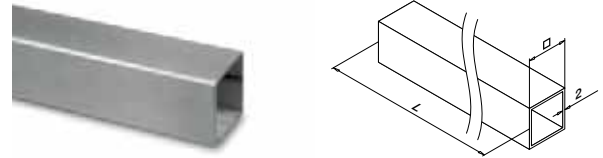

MOD 4900

V2A	304	Gebürstet		
INDOOR*		□		
134900-040-25-12	40 x 40 x 2,0		L = 2,5 m	
134900-040-50-12	40 x 40 x 2,0		L = 5 m	
V2A	304	Black Line		
INDOOR*				
NEW 134900-040-50-82	40 x 40 x 2,0		L = 5 m	
V4A	316	Gebürstet		
OUTDOOR				
144900-040-25-12	40 x 40 x 2,0		L = 2,5 m	
144900-040-50-12	40 x 40 x 2,0		L = 5 m	



Verbinder

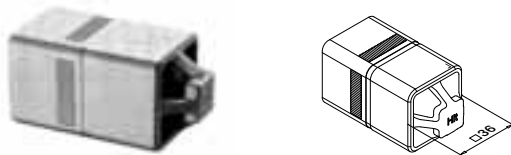

MOD 5794 - EASY HIT®

V4A	316	Roh		
OUTDOOR		Für Rohr □		
145794-040	40 x 40 x 2,0		2	



Internationaler Geschmacksmusterschutz



MOD 4790

V2A	304	Gebürstet		
INDOOR*		Für Rohr □		
134790-040-12	40 x 40 x 2,0		2	
V4A	316	Gebürstet		
OUTDOOR				
144790-040-12	40 x 40 x 2,0		2	



Q-INFO | MOD 5794-040

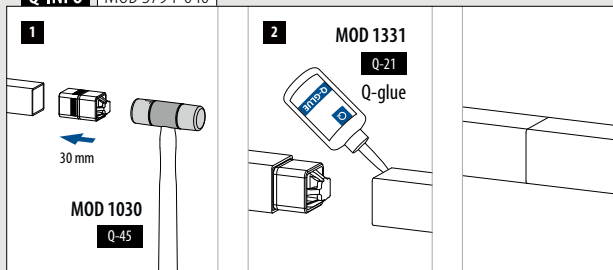

Q-INFO | MOD 4900

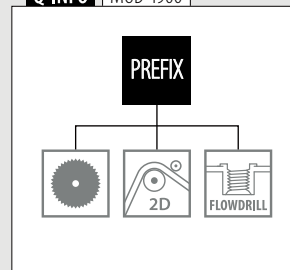

Q-INFO | 304



Verbinder

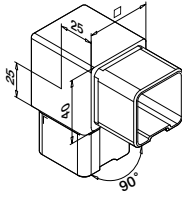

MOD 4301

V2A	304	Gebürstet		
	INDOOR*		Für Rohr <input type="checkbox"/>	
	134301-040-12		40 x 40 x 2,0	2
V4A	316	Gebürstet		
	OUTDOOR			
	144301-040-12		40 x 40 x 2,0	2

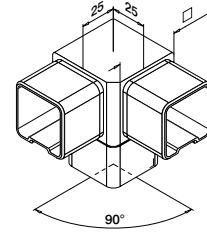

MOD 4304

V2A	304	Gebürstet		
	INDOOR*		Für Rohr <input type="checkbox"/>	
	134304-12		40 x 40 x 2,0	2
V4A	316	Gebürstet		
	OUTDOOR			
	144304-12		40 x 40 x 2,0	2



Verbinder

Justierbar

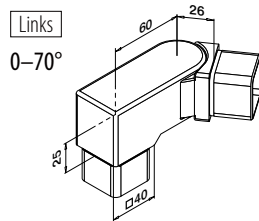

MOD 4317

V2A	304	Gebürstet		
	INDOOR*		Für Rohr <input type="checkbox"/>	
	134317-01		40 x 40 x 2,0	2

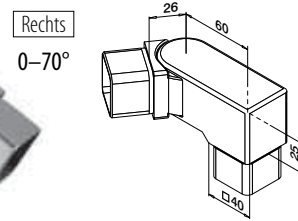

MOD 4317

V2A	304	Gebürstet		
	INDOOR*		Für Rohr <input type="checkbox"/>	
	134317-02		40 x 40 x 2,0	2

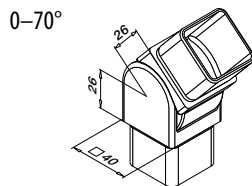

MOD 4312

V2A	304	Gebürstet		
	INDOOR*		Für Rohr <input type="checkbox"/>	
	134312-040-12		40 x 40 x 2,0	2
V4A	316	Gebürstet		
	OUTDOOR			
	144312-040-12		40 x 40 x 2,0	2



Wandflansche

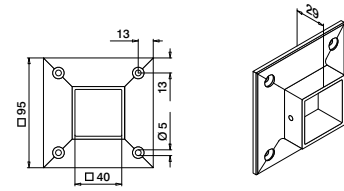

MOD 4505

V2A	304	Gebürstet		
	INDOOR*		Für Rohr <input type="checkbox"/>	
	134505-040-12		40 x 40 x 2,0	QS-5 471
V4A	316	Gebürstet		
	OUTDOOR			
	144505-040-12		40 x 40 x 2,0	QS-6 471



Q-INFO MOD 4317-01

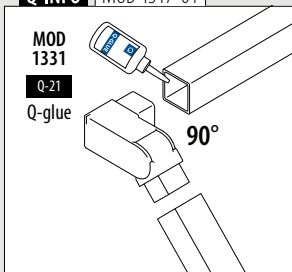

Q-INFO MOD 4317-02

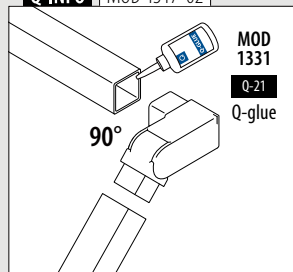

* Auch für Aussenanwendung geeignet bei entsprechenden Bedingungen.



Beanspruchung: Leicht bis hoch
Verwendung: Innen- und Aussenbereich
Montage: Boden-, In-Boden- und Seitenmontage
Anwendung: Balkone, Galerien, Wege, Abtrennungen, Treppen und Französische Balkone
Material: Edelstahl V4A (gebürstet oder pulverbeschichtet RAL 9005 schwarz)

Finden Sie alle Informationen zu Square Line® 60x30 online:



<https://q-ne.ws/SquareLine63-23>

SQUARE LINE® 60x30



Schlichtes Design, aussergewöhnlich robust

Square Line® 60x30 besticht durch seinen unverwechselbaren Look - eine ideale Lösung, wenn Sie ausdrucksvolle Akzente setzen möchten. Die Edelstahlpfosten und -handläufe des Systems überzeugen mit ihren einfachen geometrischen Formen und eignen sich für Umgebungen mit hohem Sicherheitsanspruch.

International getestet/berechnet/zertifiziert:



- 1 Der extra starke Pfosten macht Square Line® 60x30 zu einer idealen Lösung, wenn Sie ein robusteres Geländer benötigen.
- 2 Schaffen Sie dank des Industriedesigns einen modernen Look.



SQUARE LINE® 60x30 FÜLLUNGEN

Glas

- Glasrahmenrohr
- Glasklemmen
- Glasadapter
- Glashalter



▣ 386 - 390

Stab und Rohr

- Horizontale Geländerfüllung
- Vertikale Geländerfüllung



▣ 391 - 403

Drahtseil

- Fast Fix Ø 3,2 mm
- Fast Fix Ø 4,0 mm
- Easy Fix Ø 3,2 mm
- Easy Fix Ø 6,0 mm

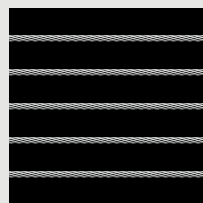

▣ 404 - 411

Netz

- Easy Q-web

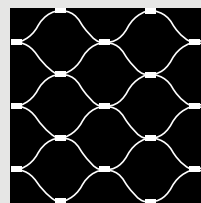

▣ 412 - 415

Blech

- Blechadapter

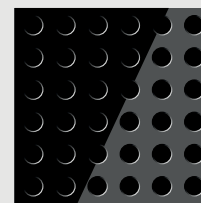

▣ 416 - 419

Geländerpfosten

Geländerpfosten

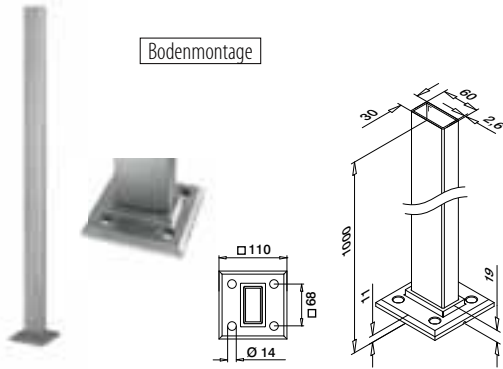

MOD 4901

V4A	316	Gebürstet			
	OUTDOOR				
	144901-063-12	60 x 30 x 2,6	QS-559	465	1
V4A	316	Black Line			
	OUTDOOR				
NEW	144901-063-82	60 x 30 x 2,6	QS-559	465	1



Geländerpfosten

Geländerpfostenrohre

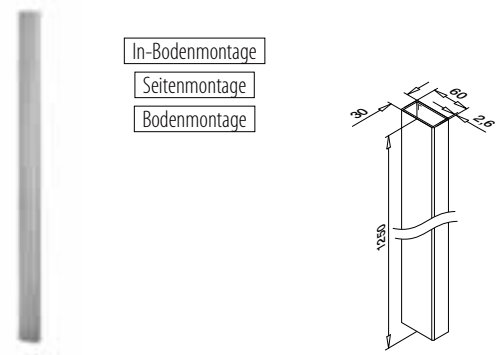

MOD 4902

V4A	316	Gebürstet			
	OUTDOOR				
	144902-063-12	60 x 30 x 2,6			1
	PREFIX				

Geländerpfosten

Abdeckkappen

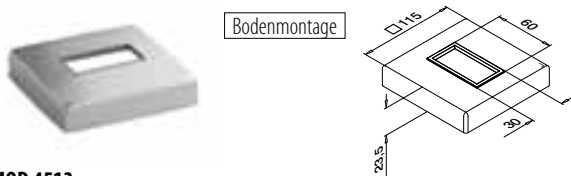

MOD 4513

V4A	316	Gebürstet			
	OUTDOOR				
	144513-063-12				2
V4A	316	Black Line			
	OUTDOOR				
NEW	144513-063-82				2



MOD 4512

V4A	316	Gebürstet			
	OUTDOOR				
	144512-063				2

Geländerpfosten

Bodenflansche für Geländerpfosten

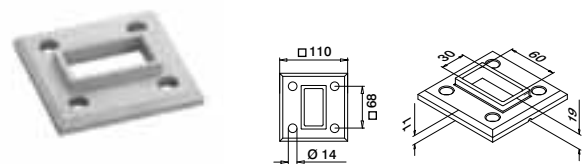

MOD 3503

V4A	316	Roh			
	OUTDOOR				
	143503-063		QS-559	465	2

Q-INFO MOD 4901 / 4902

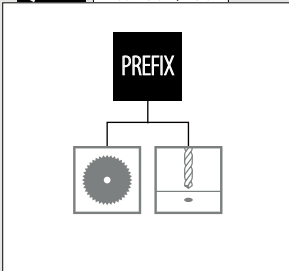

Q-INFO 316



Q-INFO MOD 4901 / 4513

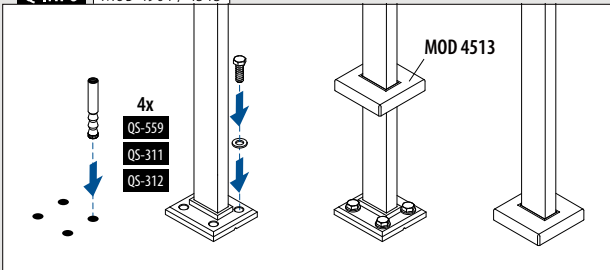

Q-INFO MOD 4902 / 4512

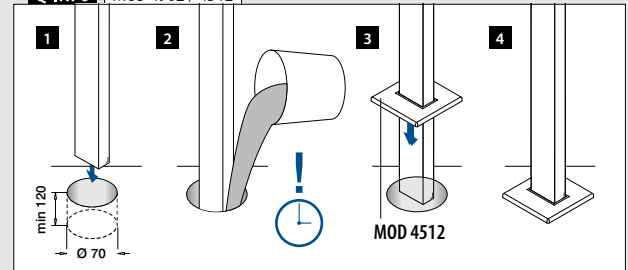

Geländerpfostenhalterungen

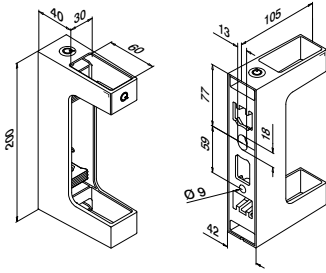

MOD 4558

V4A	316	Gebürstet			
	OUTDOOR				
	14458-063-12	60 x 30	QS-559	465	1
V4A	316	Black Line			
	OUTDOOR				
NEW	14458-063-82	60 x 30	QS-559	465	1



Internationaler Geschmacksmusterschutz

Handläufe

Endkappen

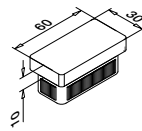

MOD 5728 - EASY HIT®

V4A	316	Gebürstet			
	OUTDOOR		Für		
	144728-063-12	60 x 30 x 2,6			2



Internationaler Geschmacksmusterschutz

Rohre

Q-TUBE

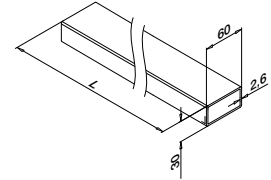

MOD 4900

V4A	316	Gebürstet			
	OUTDOOR				
	144900-063-50-12	60 x 30 x 2,6			L = 5 m



Handläufe

Handlaufadapter

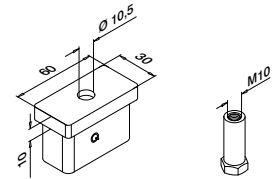

MOD 4725

V4A	316	Gebürstet			
	OUTDOOR		Für		
	144725-12	60 x 30 x 2,6	QS-48	472	2



	MOD 0811 335		MOD 0812 335		MOD 4811 296
--	------------------------	--	------------------------	--	------------------------

	MOD 1810 337		MOD 1801 337		MOD 1802 337
--	------------------------	--	------------------------	--	------------------------

Q-INFO MOD 4725

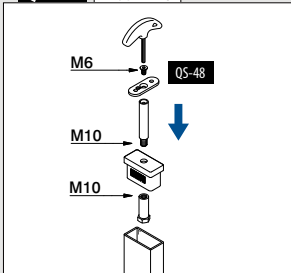

Q-INFO MOD 4900

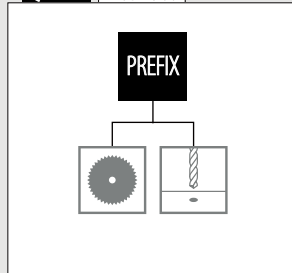

Q-INFO MOD 4558

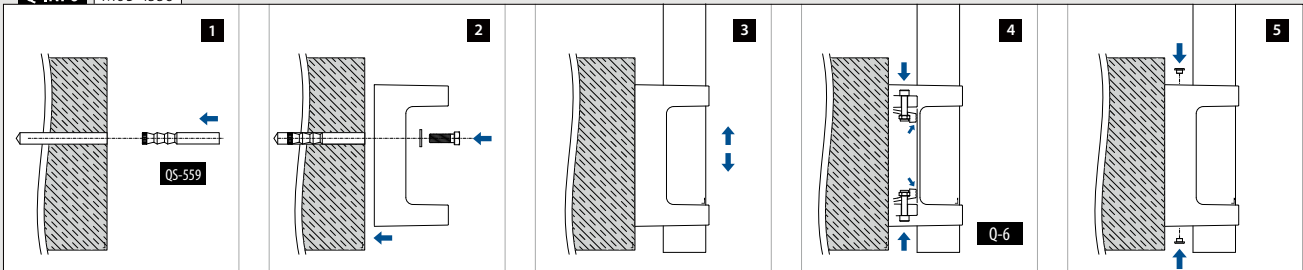

Für flaches Rohr

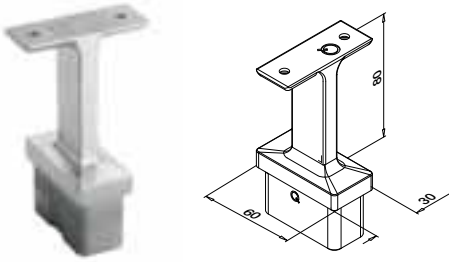

MOD 4711

V4A	316	Gebürstet	Für □	Ø	MS	MS
	OUTDOOR		60 x 30 x 2,6	QS-13	472	2
V4A	316	Black Line				
	OUTDOOR					
NEW	144711-000-82		60 x 30 x 2,6	QS-13	472	2

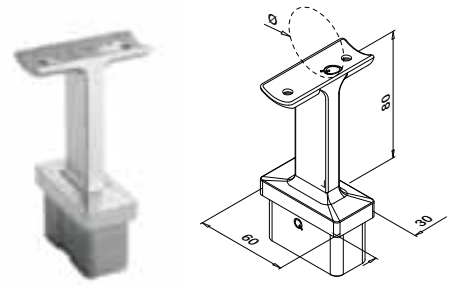
Für flaches Rohr
zu rundem Rohr

MOD 4711

V4A	316	Gebürstet	Für □	Ø	MS	MS
	OUTDOOR		60 x 30 x 2,6	42,4	QS-13	472
				48,3	QS-13	472
SELL OUT	144711-042-12			42,4	60 x 30 x 2,6	2
				48,3	60 x 30 x 2,6	2
V4A	316	Black Line				
	OUTDOOR					
NEW	144711-042-82		60 x 30 x 2,6	QS-13	472	2



Für flaches Rohr

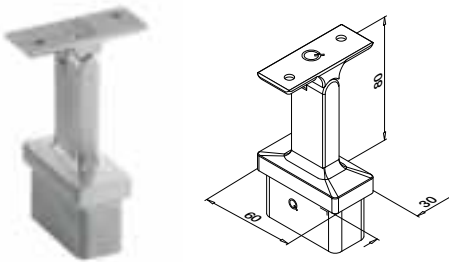

MOD 4719

V4A	316	Gebürstet	Für □	Ø	MS	MS
	OUTDOOR		60 x 30 x 2,6	QS-13	472	2

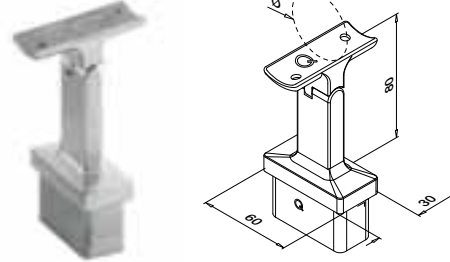
Für flaches Rohr
zu rundem Rohr

MOD 4719

V4A	316	Gebürstet	Für □	Ø	MS	MS
	OUTDOOR		60 x 30 x 2,6	42,4	QS-13	472
				48,3	QS-13	472
SELL OUT	144719-042-12			42,4	60 x 30 x 2,6	2
				48,3	60 x 30 x 2,6	2



SELL
OUT Nur solange der Vorrat reicht.

Q-INFO MOD 4711

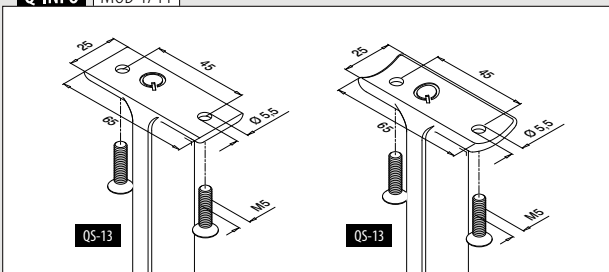

Q-INFO MOD 4719

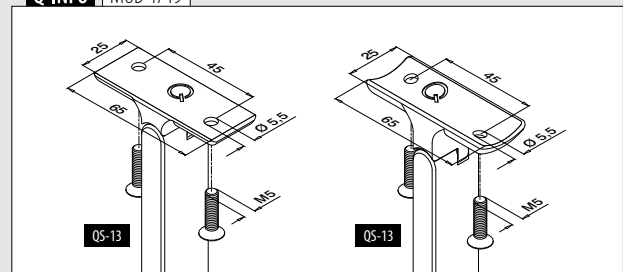

Handläufe

Rohre

Q-TUBE

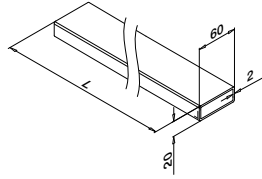

MOD 4900

V4A	316	Gebürstet		
OUTDOOR				
144900-062-25-12	60 x 20 x 2,0		L = 2,5 m	
144900-062-50-12	60 x 20 x 2,0		L = 5 m	
V4A	316	Black Line		
OUTDOOR				
NEW 144900-062-50-82	60 x 20 x 2,0		L = 5 m	



Internationaler Geschmacksmusterschutz

Handläufe

Verbinder

Justierbar



0 - 70°

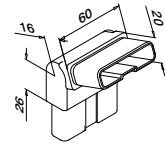

MOD 4312

V4A	316	Gebürstet		
OUTDOOR				
144312-062-12	60 x 20 x 2,0	Für Rohr		2



Internationaler Geschmacksmusterschutz

Handläufe

Verbinder

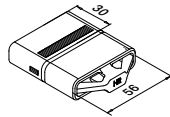

MOD 5794 - EASY HIT®

V4A	316	Roh		
OUTDOOR				
145794-062	60 x 20 x 2,0	Für Rohr		2



Internationaler Geschmacksmusterschutz

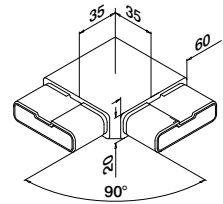

MOD 4301

V4A	316	Gebürstet		
OUTDOOR				
144301-062-12	60 x 20 x 2,0	Für Rohr		2

V4A	316	Black Line		
OUTDOOR				
NEW 144301-062-82	60 x 20 x 2,0			2



Handläufe

Endkappen

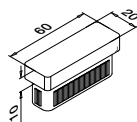

MOD 5728 - EASY HIT®

V4A	316	Gebürstet		
OUTDOOR				
145728-062-12	60 x 20 x 2,0	Für Rohr		2

V4A	316	Black Line		
OUTDOOR				
NEW 145728-062-82	60 x 20 x 2,0			2



Internationaler Geschmacksmusterschutz

Handläufe

Wandflansche

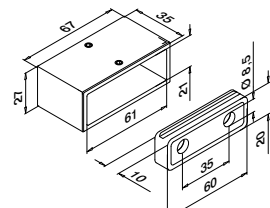

MOD 4504

V4A	316	Gebürstet		
OUTDOOR				
144504-062-12	60 x 20 x 2,0	Für Rohr	QS-55 470 / QS-27 472	2



Q-INFO MOD 5794

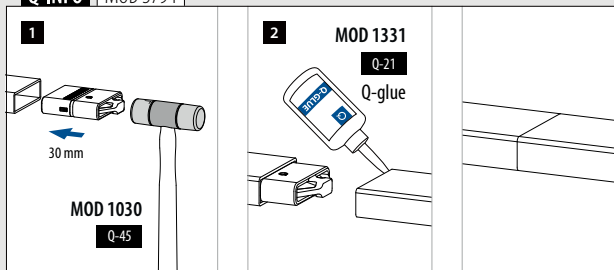

Q-INFO MOD 4900

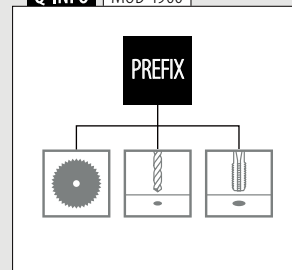

Q-INFO 316



POSTENGELENDERSYSTEME

SQUARE LINE® 60X20



- Beanspruchung:** Leicht bis hoch
Verwendung: Innen- und Aussenbereich
Montage: Boden-, In-Boden- und Seitenmontage
Anwendung: Balkone, Galerien, Wege, Abtrennungen, Treppen und Französische Balkone
Material: Edelstahl V2A oder V4A (gebürstet, hochglanzpoliert oder pulverbeschichtet RAL 9005 schwarz)

Finden Sie alle Informationen zu Q-line online:

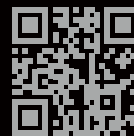

<https://q-ne.ws/QLine23>

Q-LINE



Ein Geländersystem mit grenzenlosen Gestaltungsmöglichkeiten

Q-line ist zweifellos unser vielseitigstes System. Es umfasst eine grosse Bandbreite an unterschiedlichen Komponenten, die den meisten architektonischen Herausforderungen gewachsen sind und nahezu jeder Anforderung gerecht werden. Sie können sogar ein Gelände mit einer komplett hochglanzpolierten Oberfläche erstellen. Oder wie wäre es, wenn Sie einige Elemente aus anderen Serien integrieren, um ein wirklich einzigartiges Design zu schaffen? Lassen Sie Ihrer Kreativität freien Lauf!

International getestet/berechnet/zertifiziert:



- 1 Das Q-line Sortiment ist äusserst vielseitig – es stehen neben unterschiedlichen Füllungen und Oberflächenausführungen auch verschiedene Lösungen für die Boden- und Seitenmontage sowie Treppen zur Auswahl.
- 2 Im Q-line Sortiment finden Sie auch einen doppelwandigen Pfosten (Boden- und Seitenmontage), mit dem Sie ein rundes Gelände errichten können, das Holmlasten von bis zu 0,5 kN/m standhält.

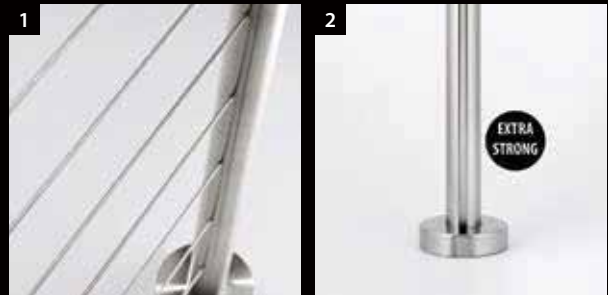

Q-LINE FÜLLUNGEN

Glas

- Glasrahmenrohr
- Glasklemmen
- Glasadapter
- Glashalter



▣ 386 - 390

Stab und Rohr

- Horizontale Geländerfüllung
- Vertikale Geländerfüllung



▣ 391 - 403

Drahtseil

- Fast Fix Ø 3,2 mm
- Fast Fix Ø 4,0 mm
- Easy Fix Ø 3,2 mm
- Easy Fix Ø 6,0 mm

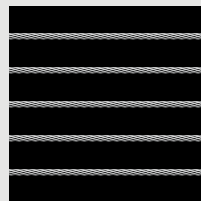

▣ 404 - 411

Netz

- Easy Q-web

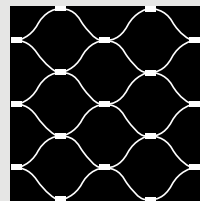

▣ 412 - 415

Blech

- Blechadapter

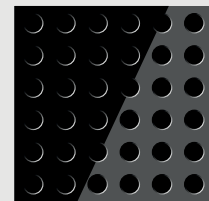

▣ 416 - 419

Geländerpfosten

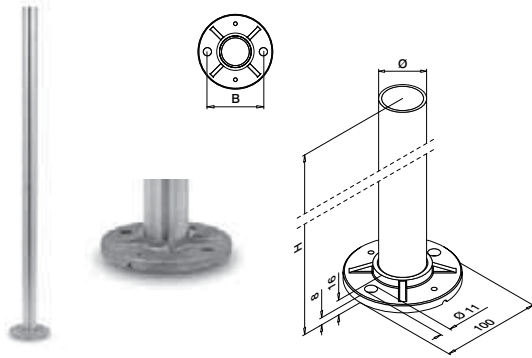

MOD 0921

V2A	304	Gebürstet	Ø	H	B		

INDOOR*

130921-242-12	42,4 x 2,0	989	75	QS-59	467	1
130921-248-12	48,3 x 2,0	989	80	QS-59	467	1

V4A	316	Gebürstet	Ø	H	B		

OUTDOOR

140921-242-12	42,4 x 2,0	989	75	QS-58	467	1
140921-248-12	48,3 x 2,0	989	80	QS-58	467	1

V4A	316	Hochglanzpoliert	Ø	H	B		

OUTDOOR

140921-242-10	42,4 x 2,0	989	75	QS-58	467	1
---------------	------------	-----	----	-------	-----	---

MOD 0944

V4A	316	Gebürstet	Ø	H	B		

OUTDOOR

140944-242-12	42,4 x 2,0	1150	75	QS-58	467	1
140944-248-12	48,3 x 2,0	1150	80	QS-58	467	1

PREFIX



Bodenflansche für Geländerpfosten

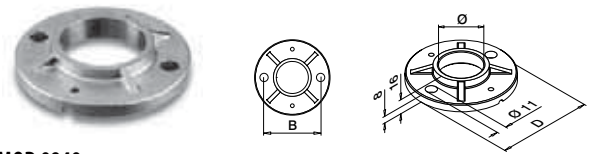

MOD 0940

V2A	304	Roh	Ø	B	D		

INDOOR*

130940-042	42,4	75	100	QS-59	467	2
130940-048	48,3	80	100	QS-59	467	2

V4A	316	Roh	Ø	B	D		

OUTDOOR

140940-042	42,4	75	100	QS-58	467	2
140940-048	48,3	80	100	QS-58	467	2

MOD 0941

V4A	316	Roh	Ø	B	D		

OUTDOOR

140941-048	48,3	90	120	QS-58	467	2
------------	------	----	-----	-------	-----	---



Abdeckkappen



MOD 0512

V2A	304	Gebürstet	Ø	D	

INDOOR*

130512-042-12	42,4	105	2
130512-048-12	48,3	105	2

V4A	316	Gebürstet	Ø	D	

OUTDOOR

140512-042-12	42,4	105	2
140512-048-12	48,3	105	2

V4A	316	Hochglanzpoliert	Ø	D	

OUTDOOR

140512-042-10	42,4	105	2
---------------	------	-----	---

MOD 0513

V4A	316	Gebürstet	Ø	D	

OUTDOOR

140513-048-12	48,3	125	2
---------------	------	-----	---

Q-INFO 316

10

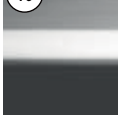
Hochglanz-
poliert

12



Gebürstet

Geländerpfosten

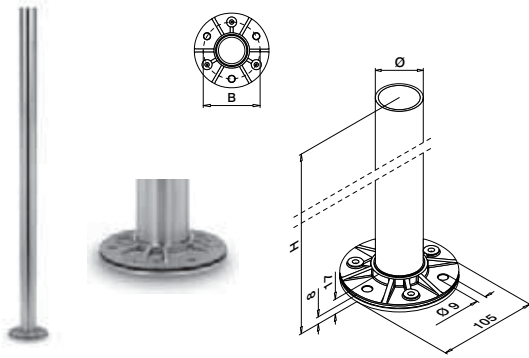

MOD 0912

V2A	304	Gebürstet				
INDOOR*			Ø	H	B	
130912-242-12	42,4 x 2,0	989	80	QS-35	467	1

V4A	316	Gebürstet				
OUTDOOR			Ø	H	B	
140912-242-12	42,4 x 2,0	989	80	QS-34	467	1



Bodenflansche für Geländerpfosten

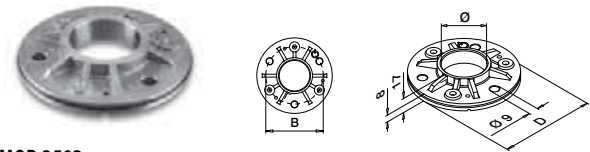

MOD 3502

V2A	304	Roh				
INDOOR*			Ø	B	D	
133502-042	42,4	80	105	QS-35	467	2
133502-048	48,3	90	115	QS-35	467	2

V4A	316	Roh				
OUTDOOR			Ø	B	D	
143502-042	42,4	80	105	QS-34	467	2
143502-048	48,3	90	115	QS-34	467	2



Abdeckkappen

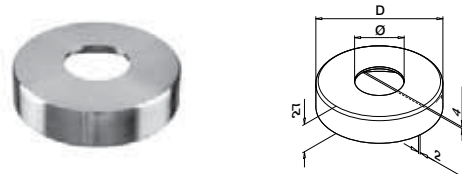

MOD 0511

V2A	304	Gebürstet			
INDOOR*		Ø	D		
130511-042-12	42,4	110	2		
130511-048-12	48,3	120	2		

V4A	316	Gebürstet			
OUTDOOR		Ø	D		
140511-042-12	42,4	110	2		
140511-048-12	48,3	120	2		

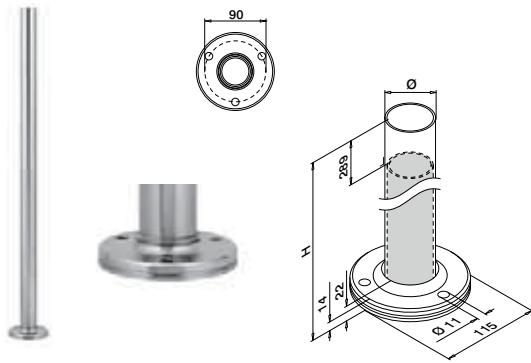

MOD 0916 - DOPPELTE WANDSTÄRKE 4,6 mm

V2A	304	Gebürstet	INDOOR*	Ø	H		
130916-548-12	48,3 x 4,6	989	QS-272	464	1		

V4A	316	Gebürstet	OUTDOOR	Ø	H		
140916-548-12	48,3 x 4,6	989	QS-273	464	1		

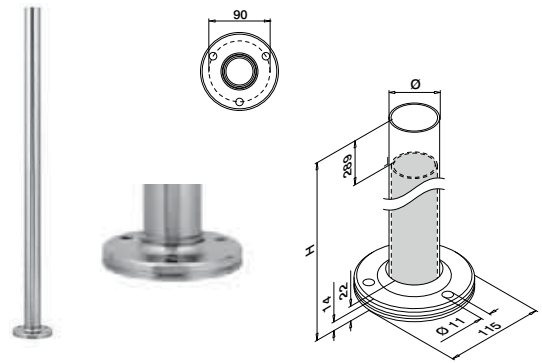

MOD 0917 - DOPPELTE WANDSTÄRKE 4,6 mm

V4A	316	Gebürstet	OUTDOOR	Ø	H		
140917-548-12	48,3 x 4,6	1089	QS-273	464	1		

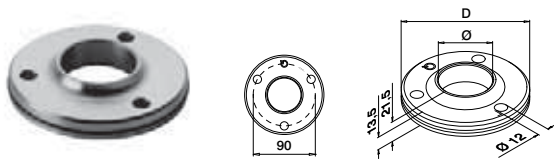

MOD 3505

V4A	316	Roh	OUTDOOR	Ø	D		
143505-048	48,3	115	QS-273	464	2		

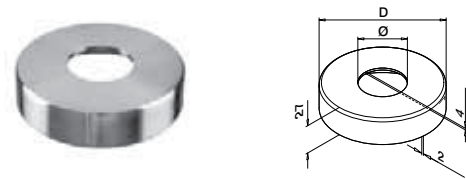

MOD 0511

V2A	304	Gebürstet	INDOOR*	Ø	D	
130511-048-12	48,3	120		2		

V4A	316	Gebürstet	OUTDOOR	Ø	D	
140511-048-12	48,3	120		2		

Q-INFO MOD 0916 / 0917

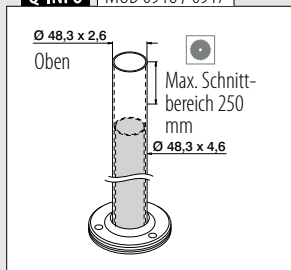

Q-INFO MOD 0916 / 0917

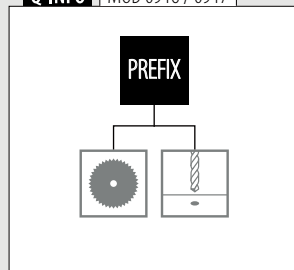

* Auch für Aussenanwendung geeignet bei entsprechenden Bedingungen.

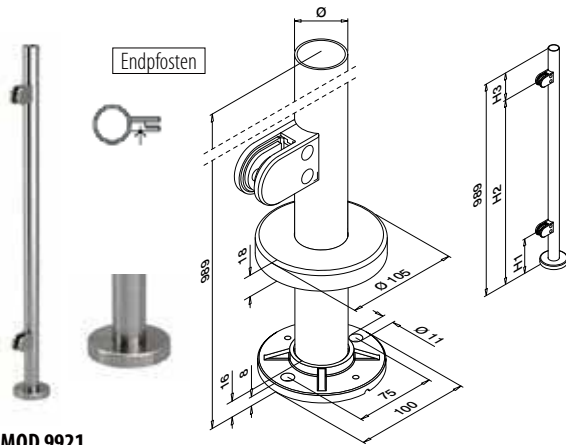

MOD 9921

V2A	304	Gebürstet						
INDOOR*			Ø	H1	H2	H3		
139921-242-01-12	42,4 x 2,0	175	869	120	QS-59	467	1	

V4A	316	Gebürstet						
OUTDOOR								
NEW	149921-242-01-12	42,4 x 2,0	175	869	120	QS-58	467	1

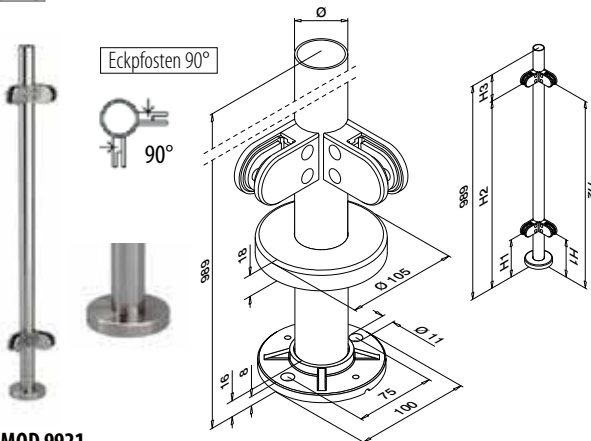

MOD 9921

V2A	304	Gebürstet						
INDOOR*			Ø	H1	H2	H3		
139921-242-90-12	42,4 x 2,0	175	869	120	QS-59	467	1	

V4A	316	Gebürstet						
OUTDOOR								
NEW	149921-242-90-12	42,4 x 2,0	175	869	120	QS-58	467	1

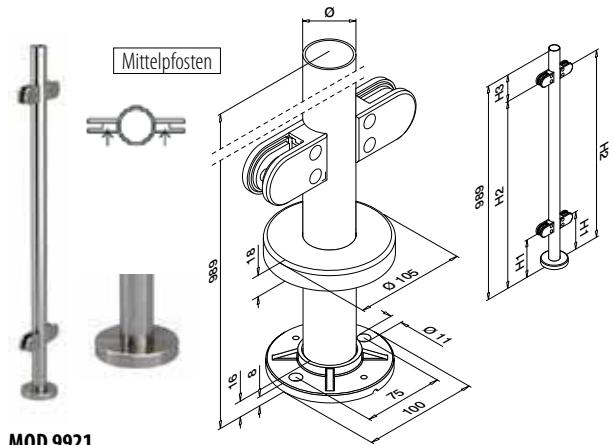

MOD 9921

V2A	304	Gebürstet						
INDOOR*			Ø	H1	H2	H3		
139921-242-02-12	42,4 x 2,0	175	869	120	QS-59	467	1	

V4A	316	Gebürstet						
OUTDOOR								
NEW	149921-242-02-12	42,4 x 2,0	175	869	120	QS-58	467	1



Füllungen

Gummeinlagen für Glasklemmen MOD 2500



2 Stück pro Glasklemme

MOD 5025

Zubehör

Für monolithisches Glas	T	
205025-06	6	8
205025-08	8	8
205025-10	10	8
205025-12	12	8

Für laminiertes Glas

205025-07	6,76	8
205025-09	8,76	8
NEW 205025-44	9,52	8
205025-11	10,76	8
NEW 205025-54	11,52	8
205025-13	12,76	8



Q-INFO

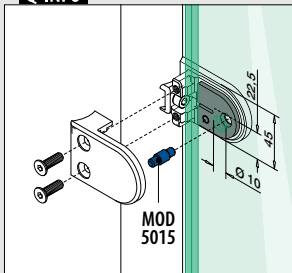

Q-INFO

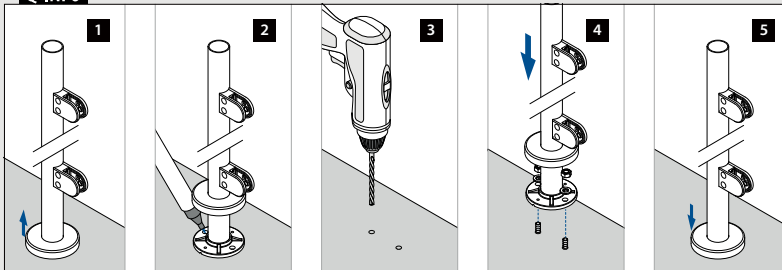

Q-INFO

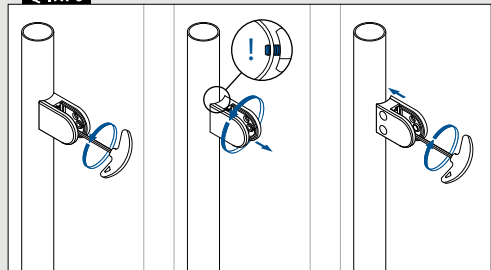

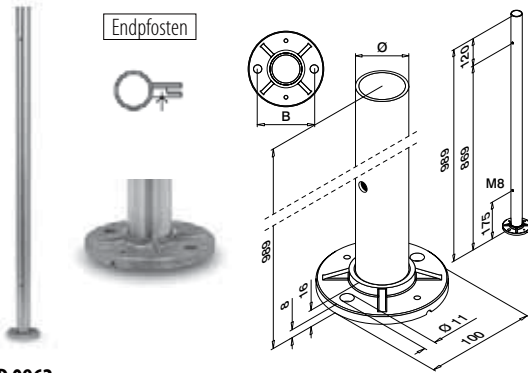

MOD 0962

V4A	316	Gebürstet	Ø	B		
	OUTDOOR					
140962-242-01-12	42,4 x 2,0	75	QS-58	467	1	
140962-248-01-12	48,3 x 2,0	80	QS-58	467	1	

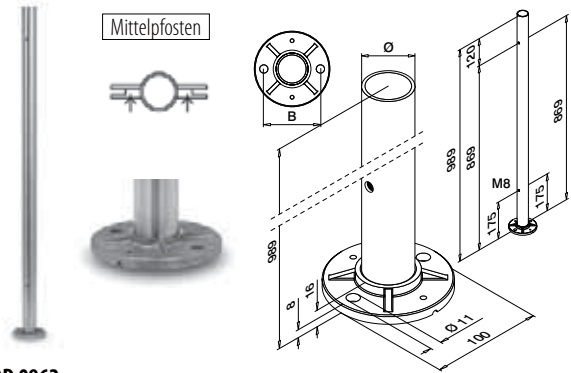

MOD 0962

V4A	316	Gebürstet	Ø	B		
	OUTDOOR					
140962-242-02-12	42,4 x 2,0	75	QS-58	467	1	
140962-248-02-12	48,3 x 2,0	80	QS-58	467	1	

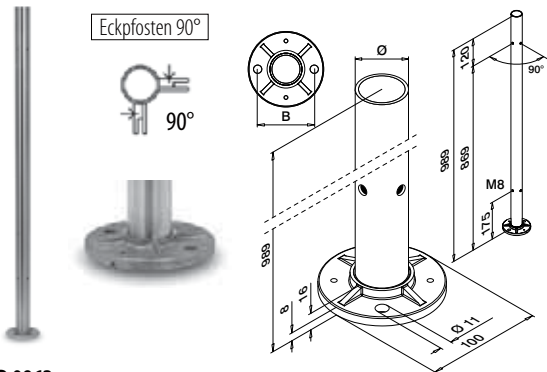

MOD 0962

V4A	316	Gebürstet	Ø	B		
	OUTDOOR					
140962-242-90-12	42,4 x 2,0	75	QS-58	467	1	
140962-248-90-12	48,3 x 2,0	80	QS-58	467	1	

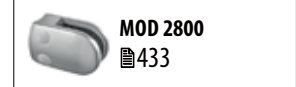
MOD 0512
Ø 315MOD 2800
Ø 433

Q-INFO | MOD 0962

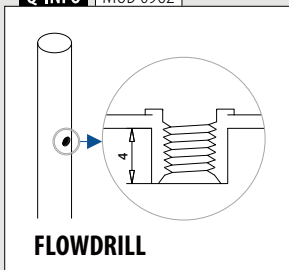

FLOWDRILL

Q-INFO



11

Schauen Sie sich unsere Prefix-Optionen für Geländerpfosten mit Glasklemmen, Querstab-, Drahtseil- und Netzhaltern an.

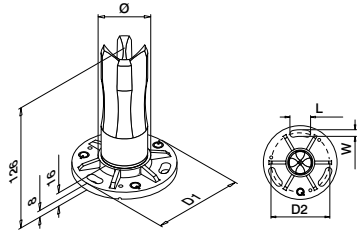

MOD 0942

V2A	304	Gebürstet						
INDOOR*	Ø	D1	D2	W x L				
130942-233	33,7 x 2,0	100	80	9x28	QS-35	467	2	
130942-242	42,4 x 2,0	100	80	9x28	QS-35	467	2	
130942-248	48,3 x 2,0	100	80	9x28	QS-35	467	2	
SELL OUT	130942-060	60,3 x 2,0	120	90	11x30	QS-35	467	2
V4A	316	Gebürstet						
OUTDOOR								
SELL OUT	140942-233	33,7 x 2,0	100	80	9x28	QS-34	467	2
140942-242	42,4 x 2,0	100	80	9x28	QS-34	467	2	
140942-248	48,3 x 2,0	100	80	9x28	QS-34	467	2	



Internationaler Geschmacksmusterschutz

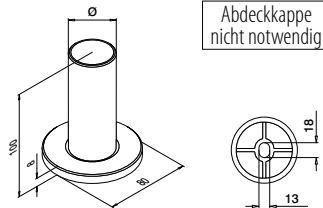

Abdeckkappe nicht notwendig

MOD 0946

V2A	304	Gebürstet						
INDOOR*	Ø							
130946-242-12	42,4 x 2,0			QS-33	464		2	

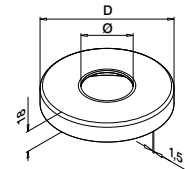

MOD 0512

V2A	304	Gebürstet			
INDOOR*	Ø	D			
130512-033-12	33,7	105	2		
130512-042-12	42,4	105	2		
130512-048-12	48,3	105	2		
V4A	316	Gebürstet			
OUTDOOR					
140512-033-12	33,7	105	2		
140512-042-12	42,4	105	2		
140512-048-12	48,3	105	2		
V4A	316	Hochglanzpoliert			
OUTDOOR					
140512-042-10	42,4	105	2		

MOD 0513

V2A	304	Gebürstet			
INDOOR*	Ø	D			
130513-042-12	42,4	125	2		
130513-048-12	48,3	125	2		
SELL OUT	130513-060-12	60,3	2		
V4A	316	Gebürstet			
OUTDOOR					
140513-042-12	42,4	125	2		
140513-048-12	48,3	125	2		

MOD 0516

V2A	304	Gebürstet			
INDOOR*	Ø				
130516-033	33,7	2			
130516-042	42,4	2			

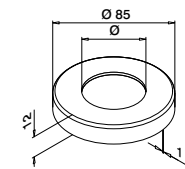

Q-INFO MOD 0942

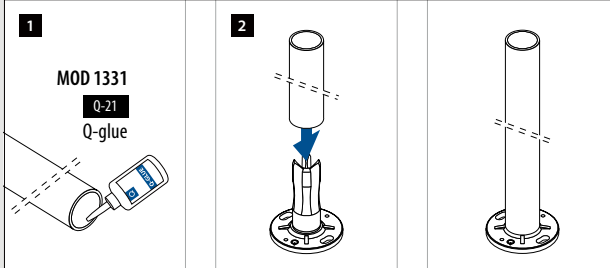

Q-INFO MOD 0946

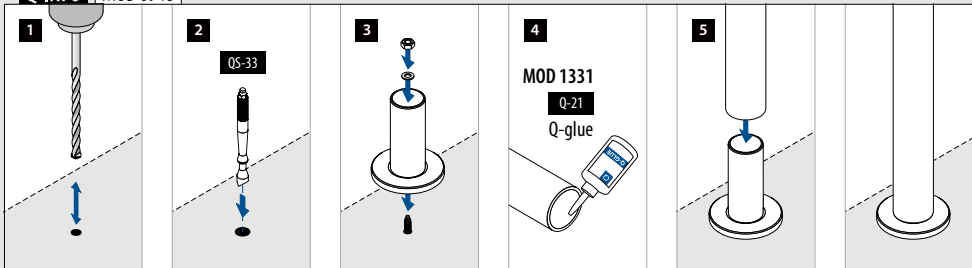

Q-INFO 316



* Auch für Aussenanwendung geeignet bei entsprechenden Bedingungen.

SELL OUT Nur solange der Vorrat reicht.

Bodenflansche

Neigung einstellbar

Für Aufsteckrohre

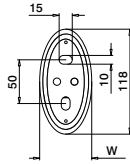
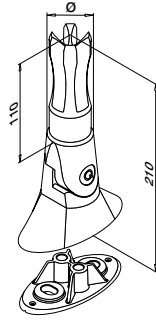
+45°
-45°

MOD 0945

V2A	304	Gebürstet			
INDOOR*		Ø	W		
130945-242	42,4 x 2,0	59	QS-65	464	1
130945-248	48,3 x 2,0	65	QS-65	464	1

V4A	316	Gebürstet			
OUTDOOR		Ø	W		
140945-242	42,4 x 2,0	59	QS-64	464	1



Geländerpfostenrohre

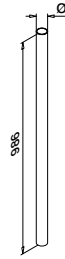

MOD 0901

V2A	304	Gebürstet			
INDOOR*		Ø			
130901-242-12	42,4 x 2,0				1

PREFIX

Q-INFO MOD 0901

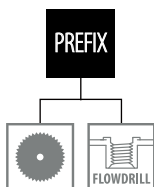

* Auch für Aussenanwendung geeignet bei entsprechenden Bedingungen.

Q-INFO MOD 0945

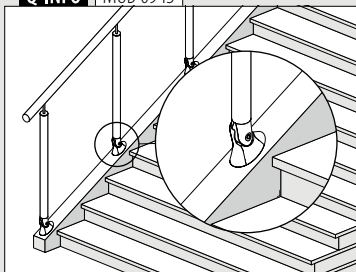

1

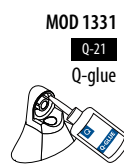

2

MOD 1331
Q-21
Q-glu

3

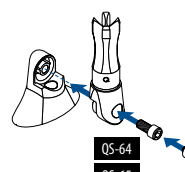
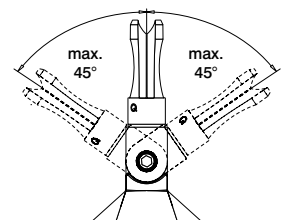
QS-64
QS-65

Geländerpfostenhalterungen

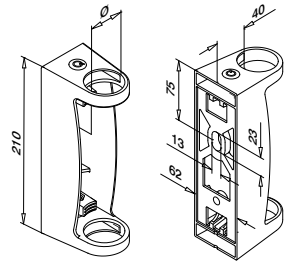
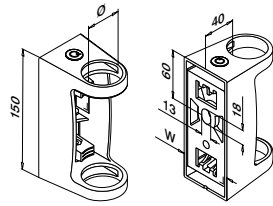

MOD 0557

V2A	304	Gebürstet			
INDOOR*		Ø			
130557-042-12	42,4	QS-33	464	1	
130557-048-12	48,3	QS-33	464	1	

V4A	316	Gebürstet			
OUTDOOR					
140557-042-12	42,4	QS-32	464	1	
140557-048-12	48,3	QS-32	464	1	



Internationaler Geschmacksmusterschutz

MOD 0558

V2A	304	Gebürstet			
INDOOR*		Ø			
130558-048-12	48,3	QS-33	464	1	

V4A	316	Gebürstet			
OUTDOOR					
140558-048-12	48,3	QS-275	464	1	



Internationaler Geschmacksmusterschutz

Geländerpfostenhalterungen

Neigung einstellbar

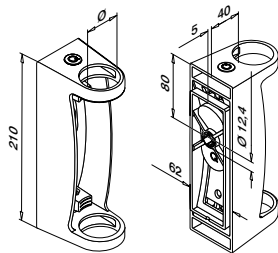

MOD 0556

V2A	304	Gebürstet			
INDOOR*		Ø			
130556-042	42,4	QS-505	465 / QS-551	472	1



Internationaler Geschmacksmusterschutz

Q-INFO MOD.0557 / 0558

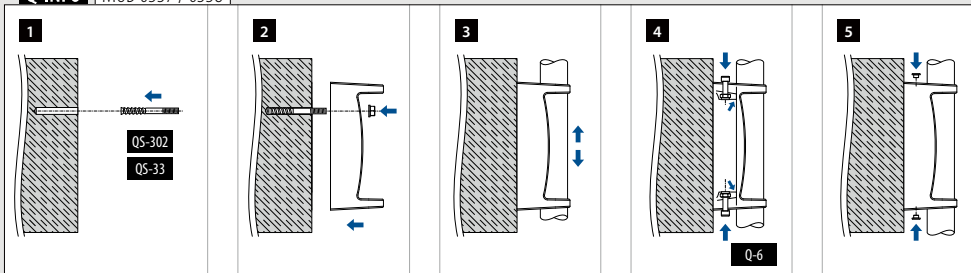

Q-INFO MOD.0556

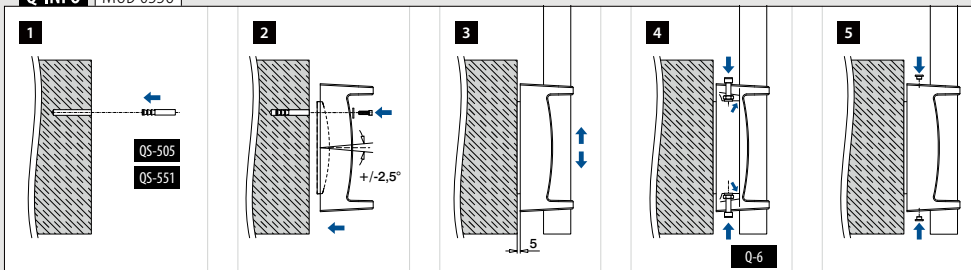

Geländerpfostenhalterungen

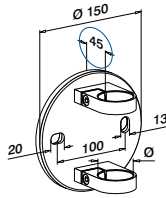

MOD 0551

V2A	304	Gebürstet			
	INDOOR*	Ø			
	130551-042-12	42,4	QS-33	464	1

V2A	304	Hochglanzpoliert			
	INDOOR*				
SELL OUT	130551-042-10	42,4	QS-33	464	1

V4A	316	Gebürstet			
	OUTDOOR				
	140551-042-12	42,4	QS-32	464	1
	140551-048-12	48,3	QS-32	464	1

V4A	316	Hochglanzpoliert			
	OUTDOOR				
	140551-042-10	42,4	QS-32	464	1

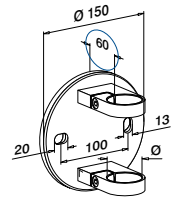

MOD 0552

V4A	316	Gebürstet			
	OUTDOOR	Ø			
	140552-042-12	42,4	QS-32	464	1
	140552-048-12	48,3	QS-32	464	1



MOD 0550

V2A	304	Gebürstet			
	INDOOR*	Ø			
	130550-042-12	42,4			2
	130550-048-12	48,3			2

V4A	316	Gebürstet			
	OUTDOOR				
	140550-042-12	42,4			2
	140550-048-12	48,3			2



Innen- und Aussenecke

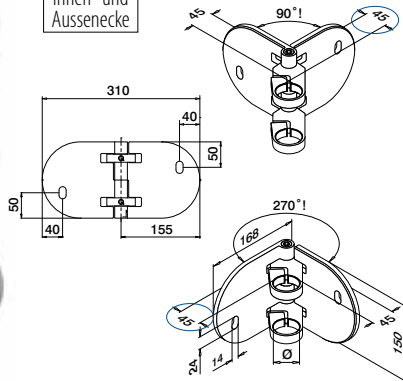

MOD 0555

V2A	304	Gebürstet			
	INDOOR*	Ø			
	130555-042-12	42,4	QS-33	464	1

V4A	316	Gebürstet			
	OUTDOOR				
	140555-042-12	42,4	QS-32	464	1
	140555-048-12	48,3	QS-32	464	1

V4A	316	Hochglanzpoliert			
	OUTDOOR				
	140555-042-10	42,4	QS-32	464	1



* Auch für Aussenanwendung geeignet bei entsprechenden Bedingungen.

SELL OUT Nur solange der Vorrat reicht.

Q-LINE PFOSTENGELÄNDERSYSTEME

Q-INFO MOD 0551 / 0552 / 0555



Q-INFO 316

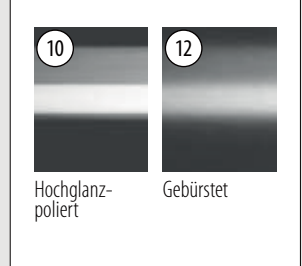

Q-INFO MOD 0551 / 0552 / 0555

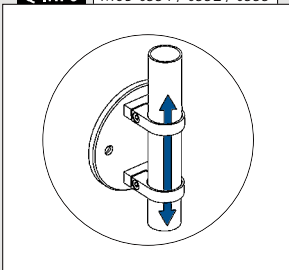

Q-INFO MOD 0551 / 0552

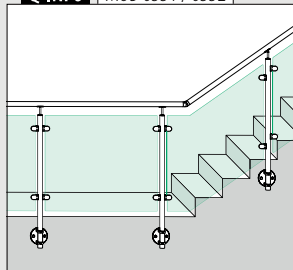

Q-INFO MOD 0550

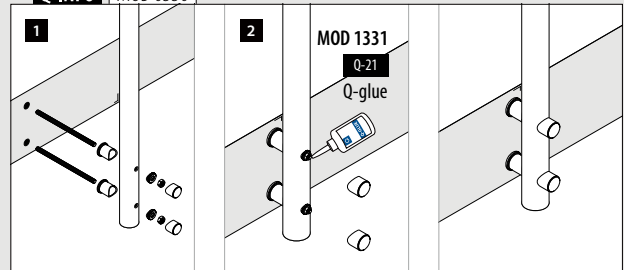

Geländerpfostenhalterungen

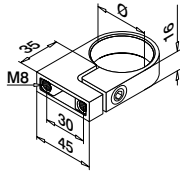

MOD 3507

V2A	304	Gebürstet	
INDOOR*		Ø	
133507-033-12	33,7		2



Nicht kombinierbar mit MOD 3508

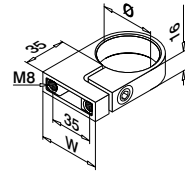

MOD 3507

V2A	304	Gebürstet	
INDOOR*		Ø	W
133507-042-12	42,4	50	2
133507-048-12	48,3	55	2

V4A	316	Gebürstet	
OUTDOOR			
143507-042-12	42,4	50	2
143507-048-12	48,3	55	2



Grundplatten für MOD 3507



Seitenmontage
Für MOD 3507-04x
Befestigungsmaterial für MOD 3507-04x ist enthalten

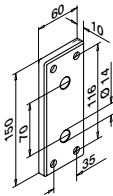

MOD 3508

V2A	304	Gebürstet	
INDOOR*			
133508-156-12	457 - 463		1

V4A	316	Gebürstet	
OUTDOOR			
143508-156-12	457 - 463		1



Seitenmontage
Für MOD 3507-04x
Befestigungsmaterial für MOD 3507-04x ist enthalten

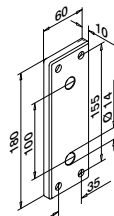

MOD 3508

V2A	304	Gebürstet	
INDOOR*			
133508-186-12	457 - 463		1

V4A	316	Gebürstet	
OUTDOOR			
143508-186-12	457 - 463		1



Seitenmontage
Für MOD 3507-04x
Befestigungsmaterial für MOD 3507-04x ist enthalten

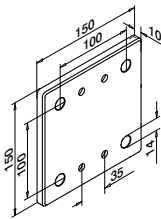

MOD 3508

V2A	304	Gebürstet	
INDOOR*			
133508-151-12	457 - 463		1

V4A	316	Gebürstet	
OUTDOOR			
143508-151-12	457 - 463		1



Q-INFO | MOD 3508-156 / 3507

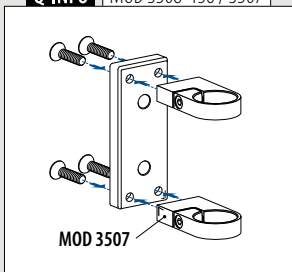

Q-INFO | MOD 3508-186 / 3507

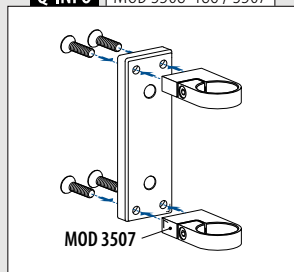

Q-INFO | MOD 3508-151 / 3507

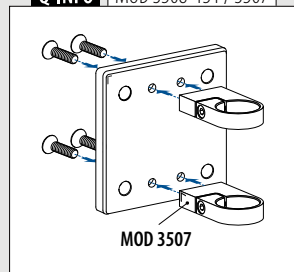

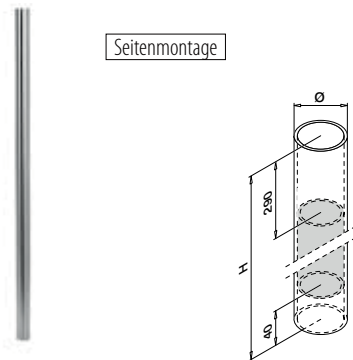

Seitenmontage

MOD 0951 - DOPPELTE WANDSTÄRKE 4,6 mm

V2A	304	Gebürstet	INDOOR*	Ø	H	
130951-548-12	48,3 x 4,6	1250	1			
V4A	316	Gebürstet	OUTDOOR	Ø	H	
140951-548-12	48,3 x 4,6	1250	1			

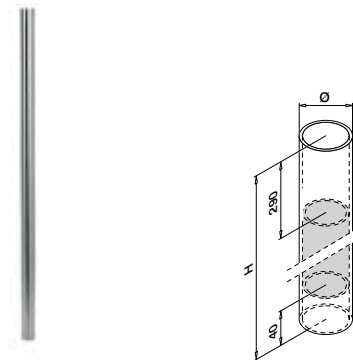
**MOD 0558**
317**MOD 5735-048**
336**MOD 0713**
324**MOD 0721**
326**MOD 0773**
333**MOD 0952 - DOPPELTE WANDSTÄRKE 4,6 mm**

V2A	304	Gebürstet	INDOOR*	Ø	H	
130952-548-12	48,3 x 4,6	1350	1			
V4A	316	Gebürstet	OUTDOOR	Ø	H	
140952-548-12	48,3 x 4,6	1350	1			



Q-INFO

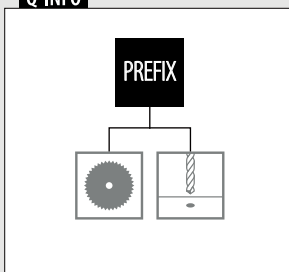

Q-INFO

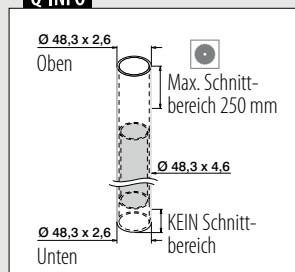

Q-INFO

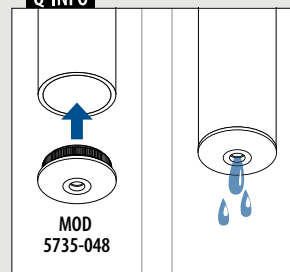

* Auch für Aussenanwendung geeignet bei entsprechenden Bedingungen.

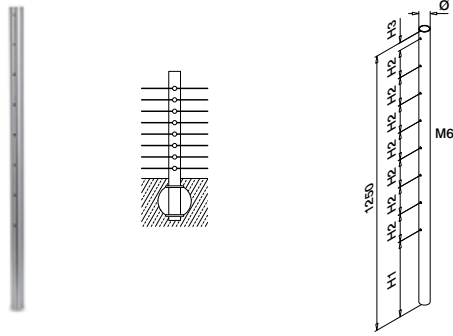

MOD 0935

V2A	304	Gebürstet					
	INDOOR*	Ø	H1	H2	H3		
130935-242-00-12	42,4 x 2,0	340	125	35	1		

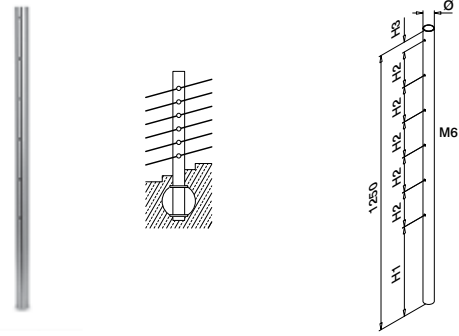

MOD 0935

V2A	304	Gebürstet					
	INDOOR*	Ø	H1	H2	H3		
130935-242-01-12	42,4 x 2,0	405	160	45	1		

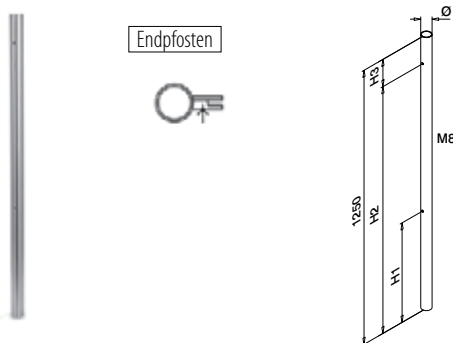
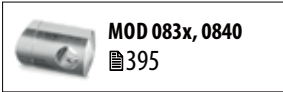

MOD 0937

V2A	304	Gebürstet					
	INDOOR*	Ø	H1	H2	H3		
130937-242-01-12	42,4 x 2,0	455	1130	120	1		

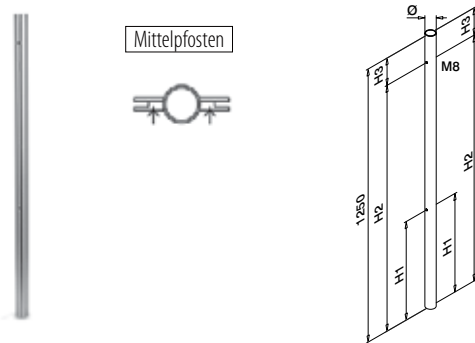

MOD 0937

V2A	304	Gebürstet					
	INDOOR*	Ø	H1	H2	H3		
130937-242-02-12	42,4 x 2,0	455	1130	120	1		

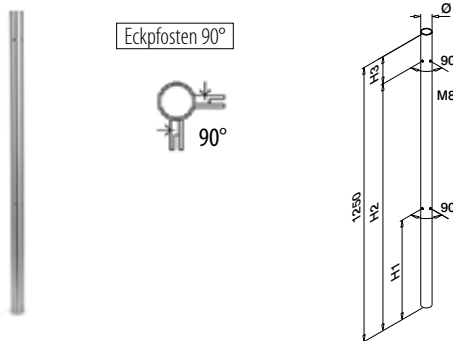

MOD 0937

V2A	304	Gebürstet					
	INDOOR*	Ø	H1	H2	H3		
130937-242-90-12	42,4 x 2,0	455	1130	120	1		

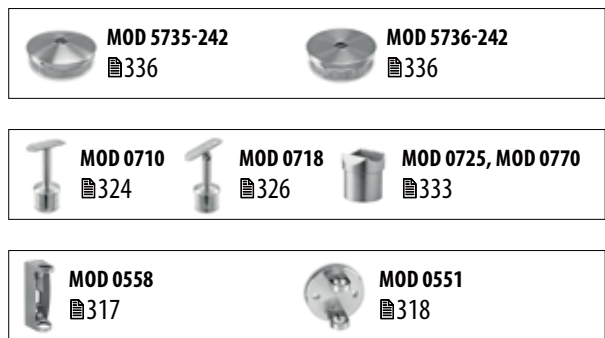
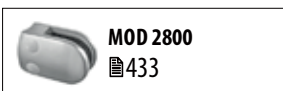

Q-INFO

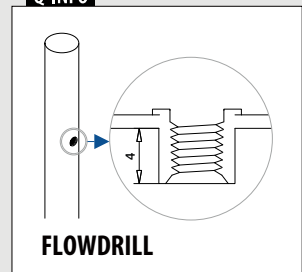

Geländerpfosten

Geländerpfosten

Für Treppen

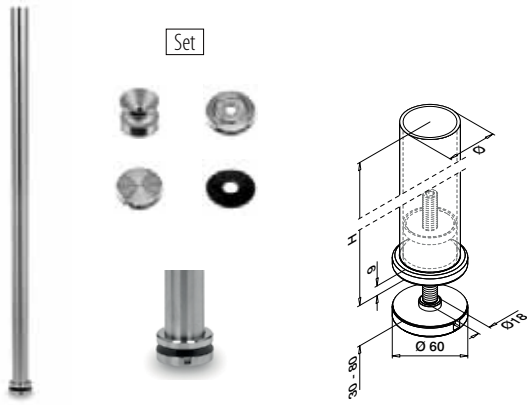

MOD 0545

V2A	304	Gebürstet		
	INDOOR*	Ø	H	
130545		42,4 x 2,0	1150	1



Geländerpfosten

Treppenflansche

Für Aufsteckrohre

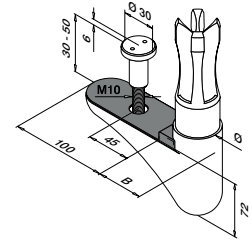

MOD 0947

V2A	304	Gebürstet		
	INDOOR*	Ø	B	
130947-242		42,4 x 2,0	48	1



Internationaler Geschmacksmusterschutz



MOD 0947

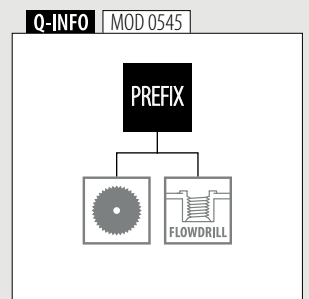
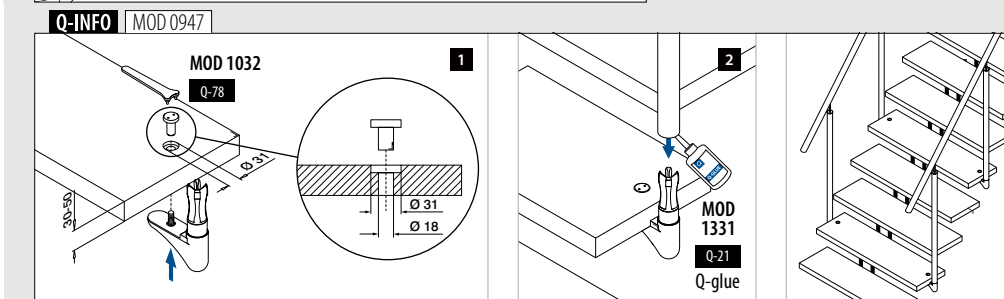
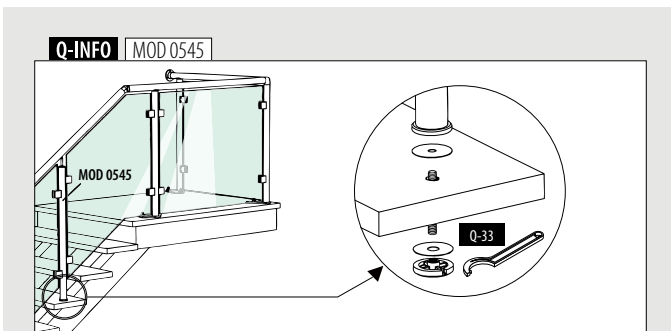

Innenkern

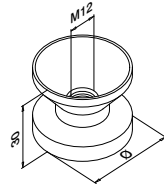

MOD 3501

V2A	304	Roh		
INDOOR*		Ø		
133501-242	42,4 x 2,0	QS-274	464	2
SELL OUT	133501-042	42,4 x 2,6	QS-274	464



Unterlegscheibe

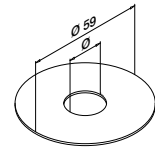

MOD 5080 / 5081

Zubehör	Ø	
205080	18	20
205081	12	20

Rosette

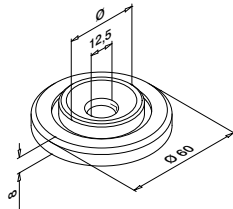

MOD 0501

V2A	304	Gebürstet		
INDOOR*		Ø		
130501-042	42,4 x 2,0 + 42,4 x 2,6		2	

Abdeckkappen

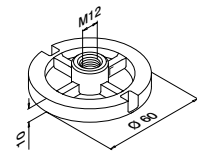

MOD 0731

V2A	304	Gebürstet		
INDOOR*				
130731			2	



Q-INFO | MOD 3501

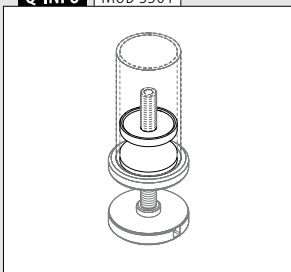

* Auch für Aussenanwendung geeignet bei entsprechenden Bedingungen.

SELL OUT Nur solange der Vorrat reicht.

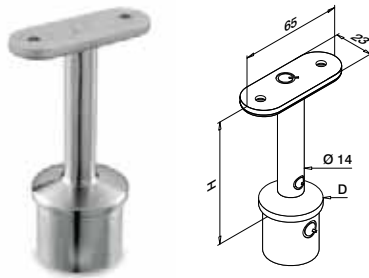
Für rundes Rohr
zu flachem Rohr

MOD 0709

V2A	304	Gebürstet				
INDOOR*		D	H			
130709-000-00-12	33,7 x 2,0	80	QS-12			2

MOD 0710

V2A	304	Gebürstet				
INDOOR*		D	H			
130710-000-00-12	42,4 x 2,0	81	QS-12			2

V4A	316	Gebürstet				
OUTDOOR		D	H			
140710-000-00-12	42,4 x 2,0	81	QS-13			2

MOD 0711

V2A	304	Gebürstet				
INDOOR*		D	H			
130711-000-00-12	48,3 x 2,0	82	QS-12			2

MOD 0712

V2A	304	Gebürstet				
INDOOR*		D	H			
130712-000-00-12	42,4 x 2,6	81	QS-12			2

V4A	316	Gebürstet				
OUTDOOR		D	H			
140712-000-00-12	42,4 x 2,6	81	QS-13			2

MOD 0713

V4A	316	Gebürstet				
OUTDOOR		D	H			
140713-000-00-12	48,3 x 2,6	82	QS-13			2



Für rundes Rohr

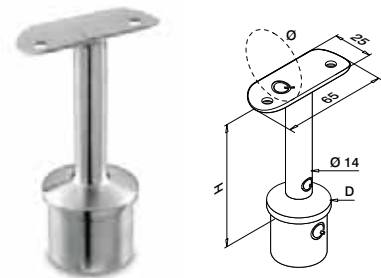

MOD 0709

V2A	304	Gebürstet				
INDOOR*		D	Ø	H		
130709-033-00-12	33,7 x 2,0	33,7	78	QS-10		
130709-042-00-12	33,7 x 2,0	42,4	78	QS-10		

MOD 0710

V2A	304	Gebürstet				
INDOOR*		D	Ø	H		
130710-042-00-12	42,4 x 2,0	42,4	79	QS-10		
130710-048-00-12	42,4 x 2,0	48,3	79	QS-10		

V4A	316	Gebürstet				
OUTDOOR		D	Ø	H		
140710-042-00-12	42,4 x 2,0	42,4	79	QS-11		

V4A	316	Hochglanzpoliert				
OUTDOOR		D	Ø	H		
140710-042-00-10	42,4 x 2,0	42,4	79	QS-11		

MOD 0711

V2A	304	Gebürstet				
INDOOR*		D	Ø	H		
130711-048-00-12	48,3 x 2,0	48,3	80	QS-10		

V4A	316	Gebürstet				
OUTDOOR		D	Ø	H		
140711-048-00-12	48,3 x 2,0	48,3	80	QS-11		

MOD 0712

V2A	304	Gebürstet				
INDOOR*		D	Ø	H		
130712-042-00-12	42,4 x 2,6	42,4	79	QS-10		
130712-048-00-12	42,4 x 2,6	48,3	79	QS-10		

V4A	316	Gebürstet				
OUTDOOR		D	Ø	H		
140712-042-00-12	42,4 x 2,6	42,4	79	QS-11		

MOD 0713

V2A	304	Gebürstet				
INDOOR*		D	Ø	H		
130713-042-00-12	48,3 x 2,6	42,4	80	QS-10		
130713-048-00-12	48,3 x 2,6	48,3	80	QS-10		

V4A	316	Gebürstet				
OUTDOOR		D	Ø	H		
140713-042-00-12	48,3 x 2,6	42,4	80	QS-11		
140713-048-00-12	48,3 x 2,6	48,3	80	QS-11		

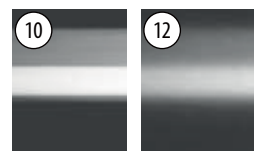

Q-INFO 316

Hochglanz-
poliert

Gebürstet

Q-INFO

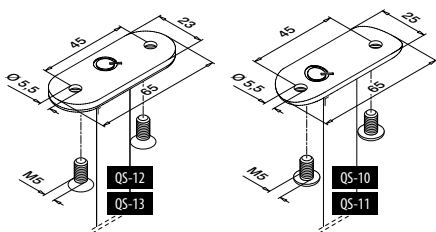

* Auch für Aussenanwendung geeignet bei entsprechenden Bedingungen.

Nur solange der Vorrat reicht.

Für rundes Rohr

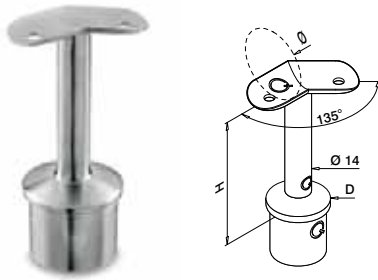

MOD 0710

V2A	304	Gebürstet						
INDOOR*			D	Ø	H			
130710-042-45-12	42,4 x 2,0	42,4	79	QS-10		472	2	
V4A	316	Gebürstet						
OUTDOOR			D	Ø	H			
140710-042-45-12	42,4 x 2,0	42,4	79	QS-11		472	2	

MOD 0711

V4A	316	Gebürstet						
OUTDOOR			D	Ø	H			
140711-048-45-12	48,3 x 2,0	48,3	80	QS-11		472	2	

MOD 0712

V2A	304	Gebürstet						
INDOOR*			D	Ø	H			
SELL OUT 130712-042-45-12	42,4 x 2,6	42,4	79	QS-10		472	2	
V4A	316	Gebürstet						
OUTDOOR			D	Ø	H			
SELL OUT 140712-042-45-12	42,4 x 2,6	42,4	79	QS-11		472	2	

MOD 0713

V4A	316	Gebürstet						
OUTDOOR			D	Ø	H			
140713-048-45-12	48,3 x 2,6	48,3	80	QS-11		472	2	

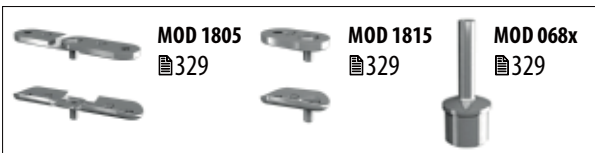

Für rundes Rohr

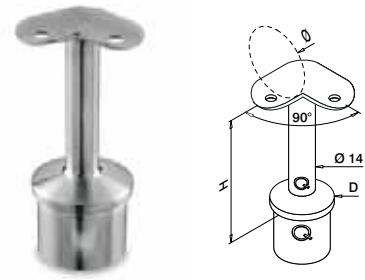

MOD 0709

V2A	304	Gebürstet						
INDOOR*			D	Ø	H			
SELL OUT 130709-033-90-12	33,7 x 2,0	33,7	78	QS-10		472	2	
SELL OUT 130709-042-90-12	33,7 x 2,0	42,4	78	QS-10		472	2	

MOD 0710

V2A	304	Gebürstet						
INDOOR*			D	Ø	H			
130710-042-90-12	42,4 x 2,0	42,4	79	QS-10		472	2	
130710-048-90-12	42,4 x 2,0	48,3	79	QS-10		472	2	

V4A	316	Gebürstet						
OUTDOOR			D	Ø	H			
140710-042-90-12	42,4 x 2,0	42,4	79	QS-11		472	2	

V4A	316	Hochglanzpoliert						
OUTDOOR			D	Ø	H			
140710-042-90-10	42,4 x 2,0	42,4	79	QS-11		472	2	

MOD 0711

V2A	304	Gebürstet						
INDOOR*			D	Ø	H			
130711-048-90-12	48,3 x 2,0	48,3	80	QS-10		472	2	

V4A	316	Gebürstet						
OUTDOOR			D	Ø	H			
140711-048-90-12	48,3 x 2,0	48,3	80	QS-11		472	2	

MOD 0712

V2A	304	Gebürstet						
INDOOR*			D	Ø	H			
SELL OUT 130712-042-90-12	42,4 x 2,6	42,4	79	QS-10		472	2	

V4A	316	Gebürstet						
OUTDOOR			D	Ø	H			
SELL OUT 140712-042-90-12	42,4 x 2,6	42,4	79	QS-11		472	2	

MOD 0713

V2A	304	Gebürstet						
INDOOR*			D	Ø	H			
130713-042-90-12	48,3 x 2,6	42,4	80	QS-10		472	2	
130713-048-90-12	48,3 x 2,6	48,3	80	QS-10		472	2	

V4A	316	Gebürstet						
OUTDOOR			D	Ø	H			
140713-048-90-12	48,3 x 2,6	48,3	80	QS-11		472	2	



Q-INFO | MOD 071x-04x-45

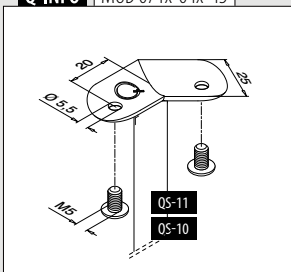

Q-INFO | MOD 071x-04x-45

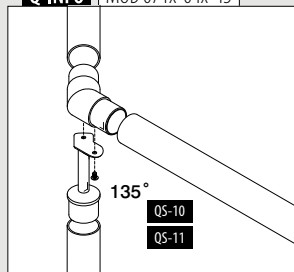

Q-INFO | MOD 07xx-04x-90

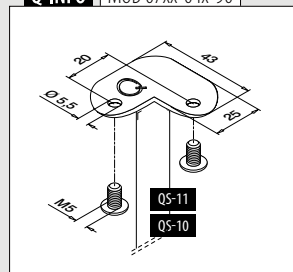

Q-INFO | MOD 07xx-04x-90

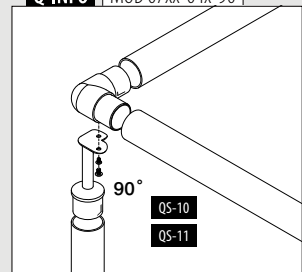

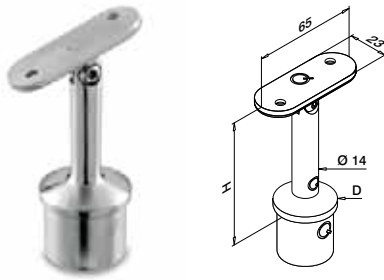
Für rundes Rohr
zu flachem Rohr

MOD 0717

V2A	304	Gebürstet				
INDOOR*		D	H			
SELL OUT	130717-000-12	33,7 x 2,0	80	QS-12	472	2

MOD 0718

V2A	304	Gebürstet				
INDOOR*		D	H			
	130718-000-12	42,4 x 2,0	81	QS-12	472	2

MOD 0720

V2A	304	Gebürstet				
INDOOR*		D	H			
SELL OUT	130720-000-12	42,4 x 2,6	81	QS-12	472	2



Für rundes Rohr

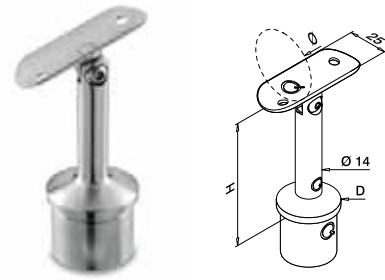

MOD 0717

V2A	304	Gebürstet					
INDOOR*		D	Ø	H			
	130717-033-12	33,7 x 2,0	33,7	78	QS-10	472	2
	130717-042-12	33,7 x 2,0	42,4	78	QS-10	472	2

MOD 0718

V2A	304	Gebürstet					
INDOOR*		D	Ø	H			
	130718-042-12	42,4 x 2,0	42,4	79	QS-10	472	2
	130718-048-12	42,4 x 2,0	48,3	79	QS-10	472	2

V4A 316 Gebürstet

OUTDOOR							
	140718-042-12	42,4 x 2,0	42,4	79	QS-11	472	2
	140718-048-12	42,4 x 2,0	48,3	79	QS-11	472	2

V4A 316 Hochglanzpoliert

OUTDOOR							
	140718-042-10	42,4 x 2,0	42,4	79	QS-11	472	2

MOD 0719

V2A	304	Gebürstet					
INDOOR*		D	Ø	H			
	130719-048-12	48,3 x 2,0	48,3	80	QS-10	472	2

V4A 316 Gebürstet

OUTDOOR							
	140719-048-12	48,3 x 2,0	48,3	80	QS-11	472	2

MOD 0720

V2A	304	Gebürstet					
INDOOR*		D	Ø	H			
SELL OUT	130720-042-12	42,4 x 2,6	42,4	79	QS-10	472	2
SELL OUT	130720-048-12	42,4 x 2,6	48,3	79	QS-10	472	2

V4A 316 Gebürstet

OUTDOOR							
SELL OUT	140720-042-12	42,4 x 2,6	42,4	79	QS-11	472	2

MOD 0721

V2A	304	Gebürstet					
INDOOR*		D	Ø	H			
	130721-042-12	48,3 x 2,6	42,4	80	QS-10	472	2
	130721-048-12	48,3 x 2,6	48,3	80	QS-10	472	2

V4A 316 Gebürstet

OUTDOOR							
	140721-042-12	48,3 x 2,6	42,4	80	QS-11	472	2
	140721-048-12	48,3 x 2,6	48,3	80	QS-11	472	2

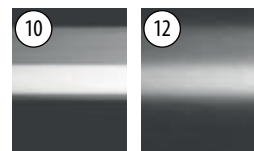

Q-INFO 304 316

Hochglanz-
poliert

Gebürstet

Q-INFO

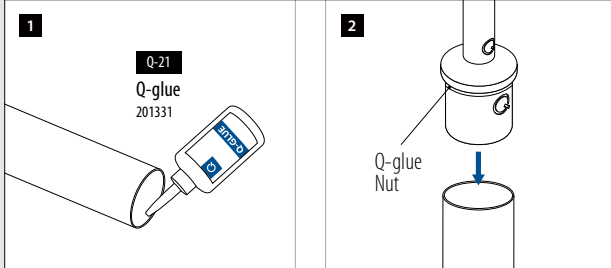

Q-INFO

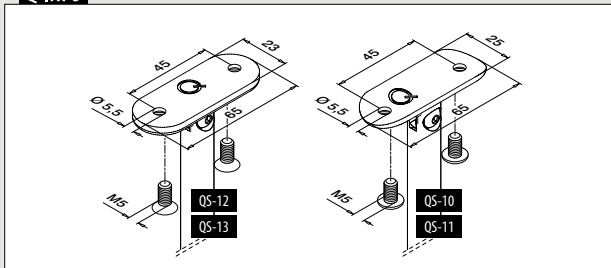

* Auch für Aussenanwendung geeignet bei entsprechenden Bedingungen.

SELL OUT Nur solange der Vorrat reicht.



Für rundes Rohr

Einstellbare Höhe

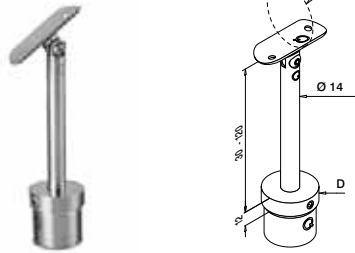

MOD 0697

V2A	304	Gebürstet				
INDOOR*		D	Ø			
130697-042	42,4 x 2,0	42,4	QS-10	472	2	
V4A	316	Gebürstet				
OUTDOOR		D	Ø			
140697-042	42,4 x 2,0	42,4	QS-11	472	2	

MOD 0699

V2A	304	Gebürstet				
INDOOR*		D	Ø			
130699-048	48,3 x 2,0	48,3	QS-10	472	2	
V4A	316	Gebürstet				
OUTDOOR		D	Ø			
140699-048	48,3 x 2,0	48,3	QS-11	472	2	



Für rundes Rohr

Einstellbare Höhe

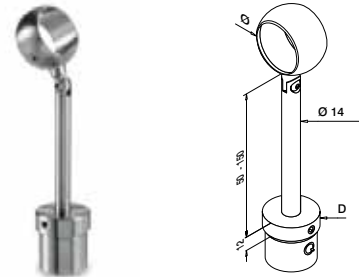

MOD 0714

V2A	304	Gebürstet				
INDOOR*		D	Ø			
SELL OUT 130714-042	42,4 x 2,6	42,4			2	
SELL OUT 130714-048	48,3 x 2,6	48,3			2	

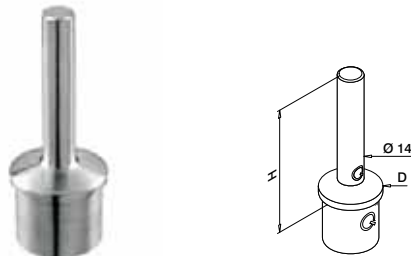

MOD 0695

V2A	304	Gebürstet				
INDOOR*		D	H			
130695	42,4 x 2,0	79			2	
V4A	316	Gebürstet				
OUTDOOR		D	H			
140695	42,4 x 2,0	79			2	

MOD 0696

V4A	316	Gebürstet				
OUTDOOR		D	H			
140696	48,3 x 2,0	80			2	



Q-INFO MOD 0714

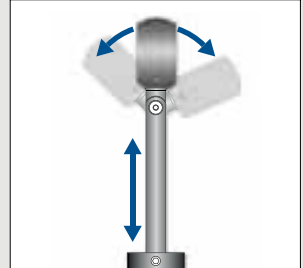

Q-INFO MOD 0697 / 0699

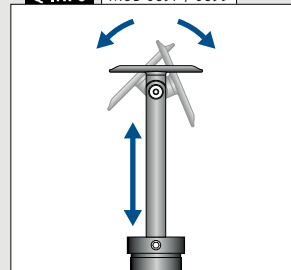

Q-INFO MOD 0697 / 0699

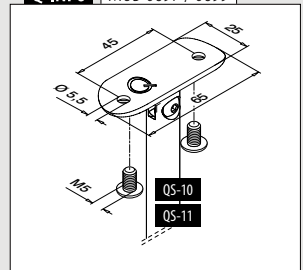

* Auch für Aussenanwendung geeignet bei entsprechenden Bedingungen.

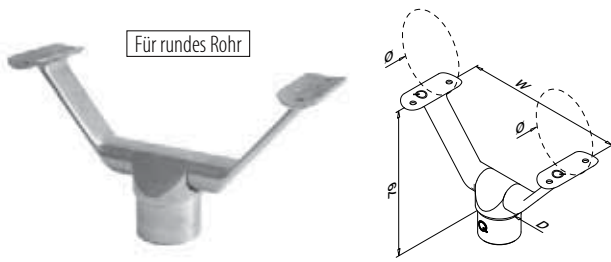

Für rundes Rohr

MOD 0693

V4A	316	Gebürstet					
	OUTDOOR	D	Ø	W			
140693-042-12	42,4 x 2,0	42,4	170	QS-11	472	2	

MOD 0694

V4A	316	Gebürstet					
	OUTDOOR	D	Ø	W			
140694-048-12	48,3 x 2,0	48,3	194	QS-11	472	2	



Internationaler Geschmacksmusterschutz

Rohrbögen

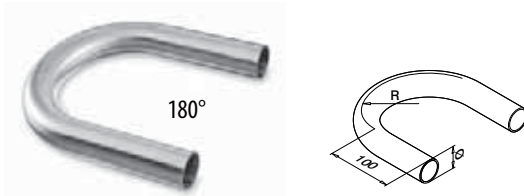

180°

MOD 0906

V2A	304	Gebürstet					
	INDOOR*	Ø	R				
130906-242-12	42,4 x 2,0	85	1				
130906-248-12	48,3 x 2,0	97	1				
V4A	316	Gebürstet					
	OUTDOOR	Ø	R				
140906-242-12	42,4 x 2,0	85	1				
140906-248-12	48,3 x 2,0	97	1				

Q-INFO MOD 0693 / 0694

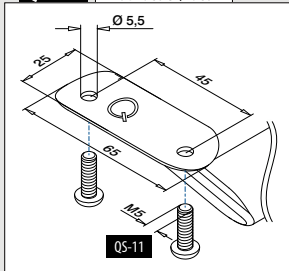

* Auch für Aussenanwendung geeignet bei entsprechenden Bedingungen.

Q-INFO MOD 0693 / 0694 / 0906

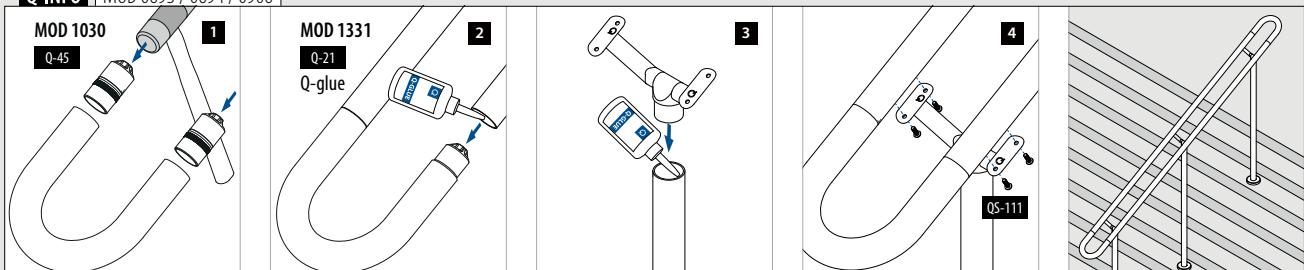

Für rundes Rohr

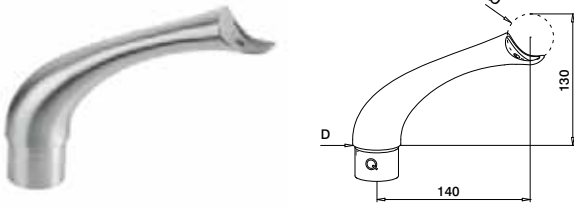

MOD 0706

V2A	304	Gebürstet			
	INDOOR*	D	Ø		
	130706	42,4 x 2,0	42,4	QS-83	472 2

V4A	316	Gebürstet			
	OUTDOOR	D	Ø		
	140706	42,4 x 2,0	42,4	QS-84	472 2



Internationaler Geschmacksmusterschutz

Für rundes Rohr

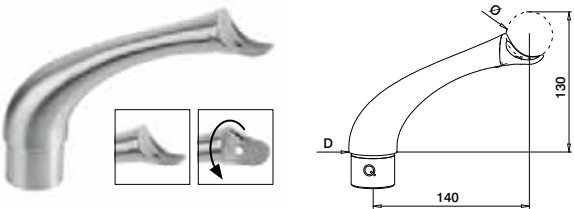

MOD 0704

V4A	316	Gebürstet			
	OUTDOOR	D	Ø		
	140704	42,4 x 2,0	42,4	QS-84	472 2



Internationaler Geschmacksmusterschutz

Für rundes Rohr

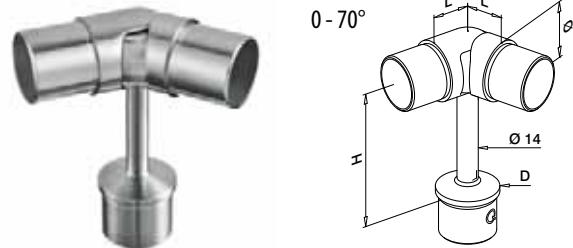

MOD 0736

V2A	304	Gebürstet				
	INDOOR*	D	Ø	H	L	
	130736-242	42,4 x 2,0	42,4 x 2,0	100	27	2

V4A	316	Gebürstet				
	OUTDOOR	D	Ø	H	L	
	140736-242	42,4 x 2,0	42,4 x 2,0	100	27	2

MOD 0737

V4A	316	Gebürstet				
	OUTDOOR	D	Ø	H	L	
	140737-248	48,3 x 2,0	48,3 x 2,0	100	30	2



Q-INFO MOD 0704

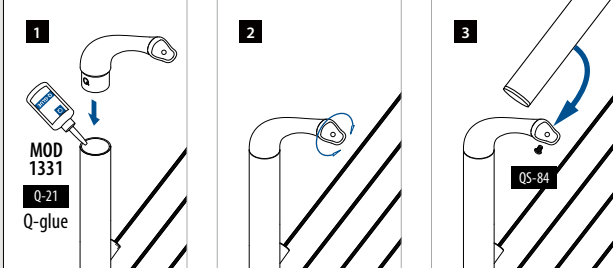

Q-INFO MOD 0706

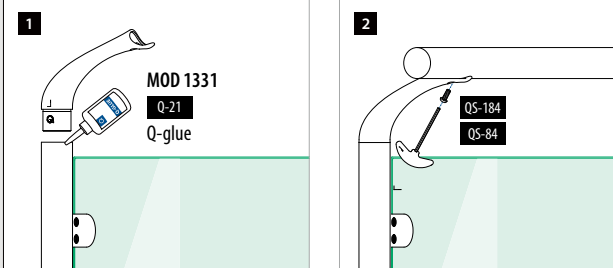

Q-INFO

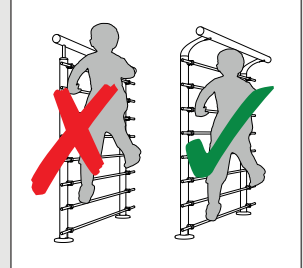

Für rundes Rohr zu flachem Rohr

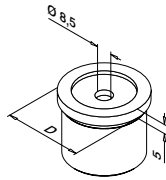

MOD 0730

V2A	304	Gebürstet			
INDOOR*		D			
130730-000	33,7 x 2,0	QS-26	472	2	

MOD 0725

V2A	304	Gebürstet			
INDOOR*		D			
130725-000	42,4 x 2,0	QS-26	472	2	

V4A	316	Gebürstet			
OUTDOOR		D			
140725-000	42,4 x 2,0	QS-27	472	2	

MOD 0727

V2A	304	Gebürstet			
INDOOR*		D			
SELL OUT	130727-000	42,4 x 2,6	QS-26	472	2

V4A	316	Gebürstet			
OUTDOOR		D			
SELL OUT	140727-000	42,4 x 2,6	QS-27	472	2

MOD 0726

V2A	304	Gebürstet			
INDOOR*		D			
130726-000	48,3 x 2,0	QS-26	472	2	

MOD 0728

V2A	304	Gebürstet			
INDOOR*		D			
SELL OUT	130728-000	48,3 x 2,6	QS 26	472	2



Für rundes Rohr



0-70°

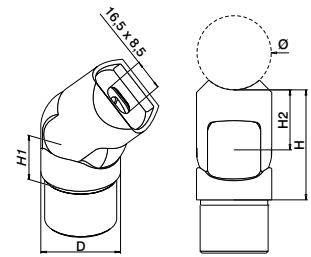

MOD 0776

V2A	304	Gebürstet							
INDOOR*		D	\varnothing	H1	H2	H			
130776-042-12	42,4 x 2,0	42,4	27	35	62	QS-26	472	2	

V4A	316	Gebürstet							
OUTDOOR		D	\varnothing	H1	H2	H			
140776-042-12	42,4 x 2,0	42,4	27	35	62	QS-27	472	2	

MOD 0777

V2A	304	Gebürstet							
INDOOR*		D	\varnothing	H1	H2	H			
130777-048-12	48,3 x 2,0	48,3	30	38	68	QS-26	472	2	

V4A	316	Gebürstet							
OUTDOOR		D	\varnothing	H1	H2	H			
140777-048-12	48,3 x 2,0	48,3	30	38	68	QS-27	472	2	



Internationaler Geschmacksmusterschutz

SELL
OUT Nur solange der Vorrat reicht.

Q-INFO | MOD 0730 / 0728x

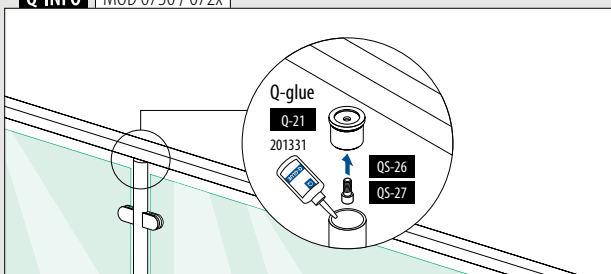

Q-INFO | MOD 0776 / 0777

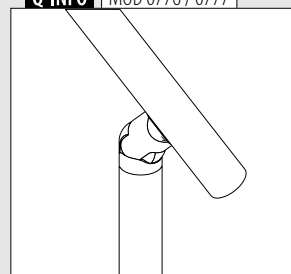

Für rundes Rohr

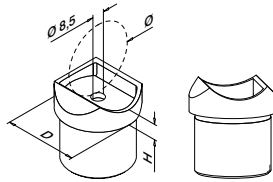

MOD 0774

V2A	304	Gebürstet	INDOOR*	D	Ø	H		
130774-12	33,7 x 2,0	33,7	8	QS-26	472	2		

Kombinierbar mit MOD 0303 Verbinder.

Für rundes Rohr

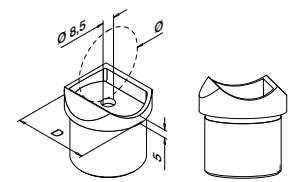

MOD 0730

V2A	304	Gebürstet	INDOOR*	D	Ø	H		
130730-042	33,7 x 2,0	42,4	8	QS-26	472	2		

MOD 0725

V2A	304	Gebürstet	INDOOR*	D	Ø	H		
130725-048	42,4 x 2,0	48,3	9	QS-26	472	2		

V4A	316	Gebürstet	OUTDOOR	D	Ø	H		
140725-048	42,4 x 2,0	48,3	9	QS-27	472	2		



Nicht kombinierbar mit MOD 0303 Verbinder.

Für rundes Rohr

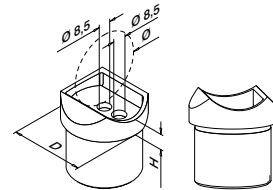

MOD 0770

V2A	304	Gebürstet	INDOOR*	D	Ø	H		
130770-042-12	42,4 x 2,0	42,4	9	QS-26	472	2		

V4A	316	Gebürstet	OUTDOOR	D	Ø	H		
140770-042-12	42,4 x 2,0	42,4	9	QS-27	472	2		

V4A	316	Hochglanzpoliert	OUTDOOR	D	Ø	H		
140770-042-10	42,4 x 2,0	42,4	9	QS-27	472	2		

MOD 0772

V2A	304	Gebürstet	INDOOR*	D	Ø	H		
SELL OUT 130772-042-12	42,4 x 2,6	42,4	9	QS-26	472	2		

V4A	316	Gebürstet	OUTDOOR	D	Ø	H		
SELL OUT 140772-042-12	42,4 x 2,6	42,4	9	QS-27	472	2		

MOD 0771

V2A	304	Gebürstet	INDOOR*	D	Ø	H		
130771-048-12	48,3 x 2,0	48,3	11	QS-26	472	2		

V4A	316	Gebürstet	OUTDOOR	D	Ø	H		
140771-048-12	48,3 x 2,0	48,3	11	QS-27	472	2		

MOD 0773

V2A	304	Gebürstet	INDOOR*	D	Ø	H		
130773-048-12	48,3 x 2,6	48,3	11	QS-26	472	2		

V4A	316	Gebürstet	OUTDOOR	D	Ø	H		
140773-048-12	48,3 x 2,6	48,3	11	QS-27	472	2		



Kombinierbar mit MOD 0303 Verbinder.

* Auch für Aussenanwendung geeignet bei entsprechenden Bedingungen.

Q-INFO 316

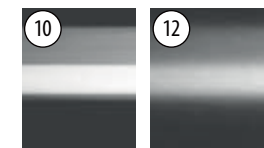

Hochglanzpoliert

Gebürstet

Q-INFO MOD 077x

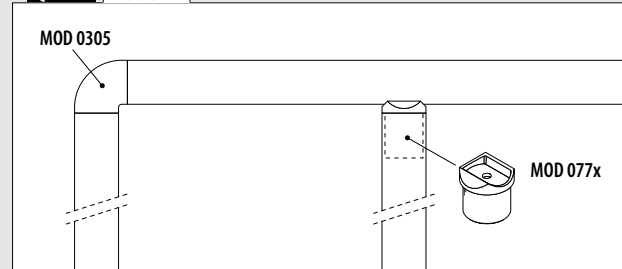

Q-INFO MOD 077x

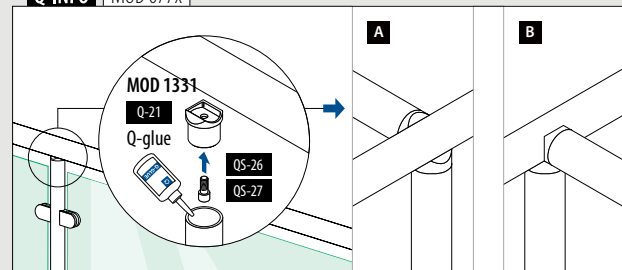

Für flaches Rohr

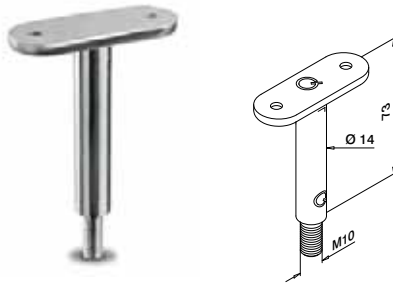

MOD 0810

V2A	304	Gebürstet		
INDOOR*				
SELL OUT	130810-000-00	QS-12	472	2



Für rundes Rohr

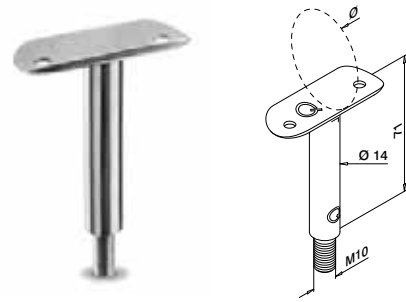

MOD 0810

V2A	304	Gebürstet		
INDOOR*				
		Ø		
	130810-042-00	42,4	QS-10	472
	130810-048-00	48,3	QS-10	472

V4A	316	Gebürstet		
OUTDOOR				
	140810-042-00	42,4	QS-11	472
	140810-048-00	48,3	QS-11	472



Für flaches Rohr

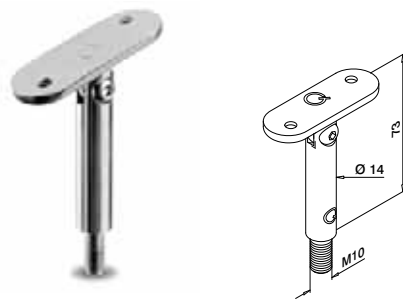

MOD 0818

V2A	304	Gebürstet		
INDOOR*				
SELL OUT	130818-000	QS-12	472	2



Für rundes Rohr

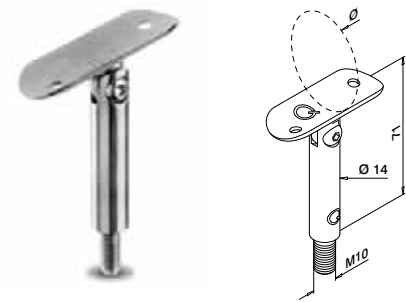

MOD 0818

V2A	304	Gebürstet		
INDOOR*				
		Ø		
	130818-042	42,4	QS-10	472
	130818-048	48,3	QS-10	472

V4A	316	Gebürstet		
OUTDOOR				
	140818-042	42,4	QS-11	472
	140818-048	48,3	QS-11	472



* Auch für Aussenanwendung geeignet bei entsprechenden Bedingungen.

Nur solange der Vorrat reicht.

Q-INFO | MOD 0810

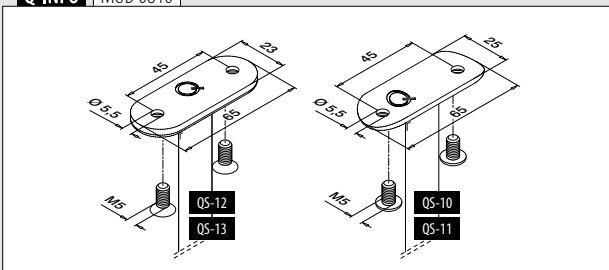

Q-INFO | MOD 0818

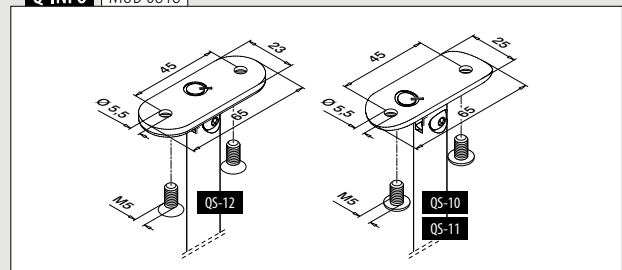

Für rundes Rohr

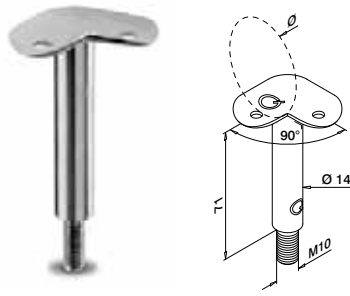

MOD 0810

V2A	304	Gebürstet		
INDOOR*				
130810-042-90	42,4	QS-10	472	2
130810-048-90	48,3	QS-10	472	2
V4A	316	Gebürstet		
OUTDOOR				
140810-042-90	42,4	QS-11	472	2
140810-048-90	48,3	QS-11	472	2

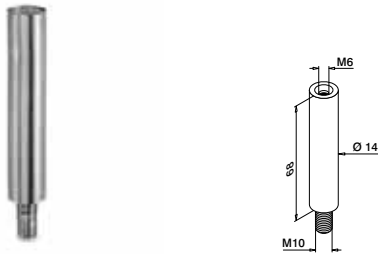

MOD 0811

V2A	304	Gebürstet		
INDOOR*				
130811	QS-48	472		2
V4A	316	Gebürstet		
OUTDOOR				
140811	QS-89	472		2

MOD 4811
 296

MOD 4733
 296



MOD 0812

V2A	304	Gebürstet		
INDOOR*				
130812	QS-48	472		2
V4A	316	Gebürstet		
OUTDOOR				
140812	QS-89	472		2



Q-INFO MOD 0810-04x-90

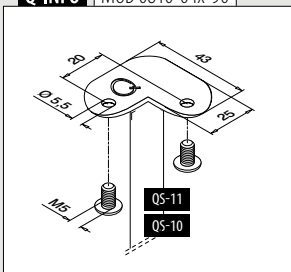

Q-INFO MOD 0811 / 0812

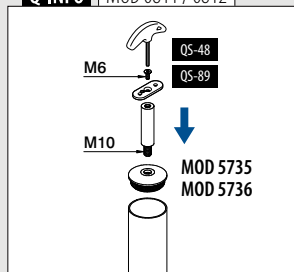

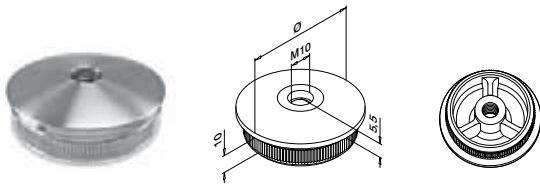

MOD 5735 - EASY HIT®

V2A	304	Gebürstet		
INDOOR*				
			Ø	
	135735-242		42,4 x 2,0	2
SELL OUT	135735-042		42,4 x 2,6	2
	135735-248		48,3 x 2,0	2
	135735-048		48,3 x 2,6	2
V4A	316	Gebürstet		
OUTDOOR				
	145735-242		42,4 x 2,0	2
SELL OUT	145735-042		42,4 x 2,6	2
	145735-248		48,3 x 2,0	2
	145735-048		48,3 x 2,6	2
SELL OUT	145735-060		60,3 x 2,0	2

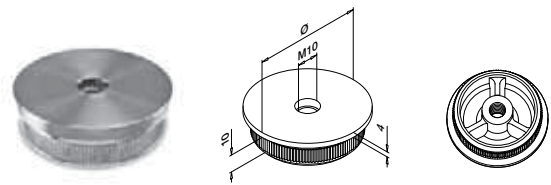

MOD 5736 - EASY HIT®

V2A	304	Gebürstet		
INDOOR*				
			Ø	
	135736-242		42,4 x 2,0	2
SELL OUT	135736-042		42,4 x 2,6	2
	135736-248		48,3 x 2,0	2
	135736-048		48,3 x 2,6	2
V4A	316	Gebürstet		
OUTDOOR				
	145736-242		42,4 x 2,0	2
	145736-248		48,3 x 2,0	2



Für flaches Rohr



MOD 3302

V4A	316	Gebürstet		
OUTDOOR				
	143302-000-12		QS-12	472



Für rundes Rohr

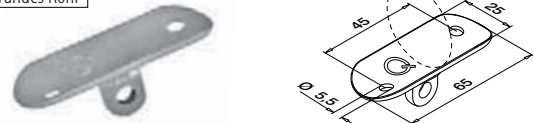

MOD 3302

V4A	316	Gebürstet		
OUTDOOR				
	143302-042-12		42,4	QS-11
	143302-048-12		48,3	QS-11



* Auch für Aussenanwendung geeignet bei entsprechenden Bedingungen.

Handlauf-Anschlussplatten

Für flaches Rohr



MOD 1810

V2A	304	Gebürstet		
INDOOR*				
131810-000-12	QS-48	472 / QS-10	472	8
V4A	316	Gebürstet		
OUTDOOR				
141810-000-12	QS-89	472 / QS-11	472	8



Für rundes Rohr



MOD 1810

V2A	304	Gebürstet		
INDOOR*				
131810-033-12	33,7	QS-48	472 / QS-10	472
131810-042-12	42,4	QS-48	472 / QS-10	472
131810-048-12	48,3	QS-48	472 / QS-10	472
V4A	316	Gebürstet		
OUTDOOR				
141810-042-12	42,4	QS-89	472 / QS-11	472
141810-048-12	48,3	QS-89	472 / QS-11	472



Für flaches Rohr

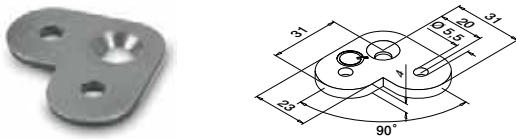

MOD 1802

V2A	304	Gebürstet		
INDOOR*				
131802-000	QS-48	472 / QS-10	472	8



Für rundes Rohr

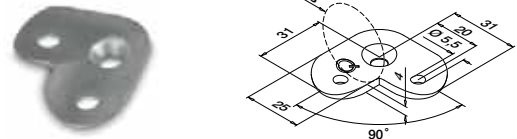

MOD 1802

V2A	304	Gebürstet		
INDOOR*				
131802-042	42,4	QS-48	472 / QS-10	472
131802-048	48,3	QS-48	472 / QS-10	472



Für flaches Rohr

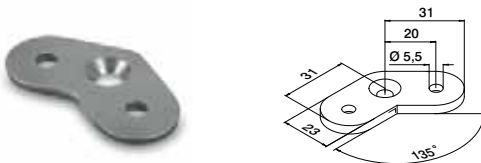

MOD 1801

V2A	304	Gebürstet		
INDOOR*				
131801-000	QS-48	472 / QS-10	472	8



Für rundes Rohr

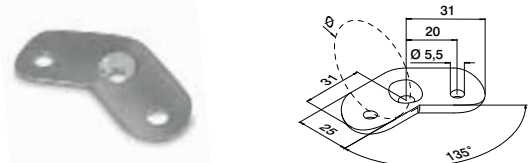

MOD 1801

V2A	304	Gebürstet		
INDOOR*				
131801-042	42,4	QS-48	472 / QS-10	472
131801-048	48,3	QS-48	472 / QS-10	472

SELL
OUT

Für rundes Rohr

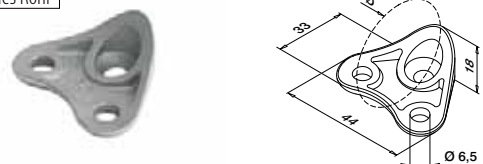

MOD 1820

V4A	316	Gebürstet		
OUTDOOR				
141820-042-12	42,4	QS-89	472 / QS-11	472

Kombinierbar mit MOD 0305 Verbinder.
Internationaler Geschmacksmusterschutz

Für flaches Rohr

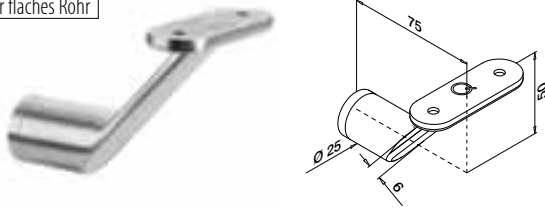

MOD 0123

V2A	304	Gebürstet		
INDOOR*				
130123-000-12	QS-12	472 / QS-21	472	2
V4A	316	Gebürstet		
OUTDOOR				
140123-000-12	QS-13	472 / QS-22	472	2



Internationaler Geschmacksmusterschutz

Für flaches Rohr zu rundem Rohr

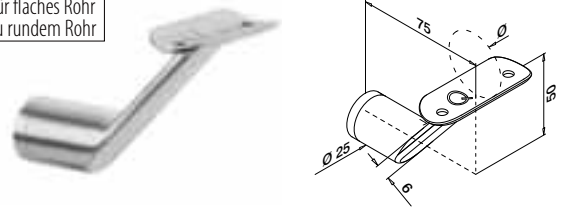

MOD 0123

V2A	304	Gebürstet		
INDOOR*				
130123-042-12	42,4	QS-10	472 / QS-21	472
130123-048-12	48,3	QS-10	472 / QS-21	472
V4A	316	Gebürstet		
OUTDOOR				
140123-042-12	42,4	QS-11	472 / QS-22	472



Internationaler Geschmacksmusterschutz

Für rundes Rohr

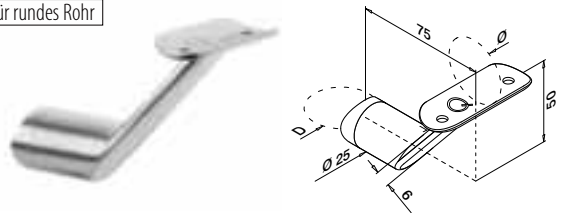

MOD 0124

V2A	304	Gebürstet		
INDOOR*				
130124-042-12	42,4	42,4	QS-10	472 / QS-21
130124-048-12	48,3	48,3	QS-10	472 / QS-21
V4A	316	Gebürstet		
OUTDOOR				
140124-042-12	42,4	42,4	QS-11	472 / QS-22

MOD 0125

V2A	304	Gebürstet		
INDOOR*				
130125-042-12	48,3	42,4	QS-10	472 / QS-21
130125-048-12	48,3	48,3	QS-10	472 / QS-21
V4A	316	Gebürstet		
OUTDOOR				
140125-048-12	48,3	48,3	QS-11	472 / QS-22



Internationaler Geschmacksmusterschutz

Q-INFO

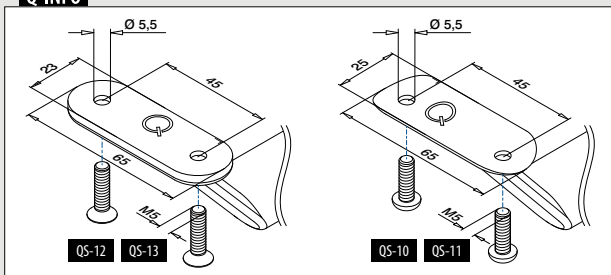

Q-INFO

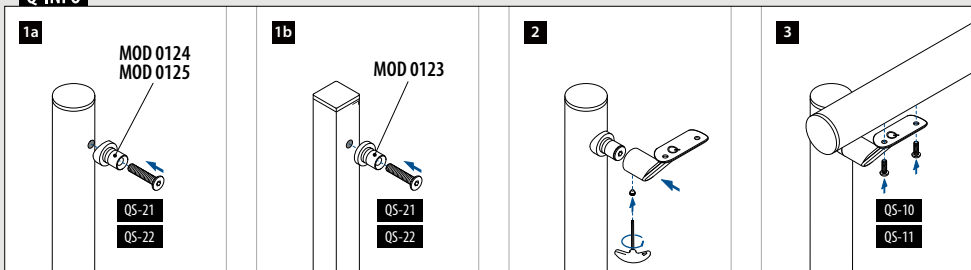

Für flaches Rohr zu rundem Rohr
Einstellbare Höhe

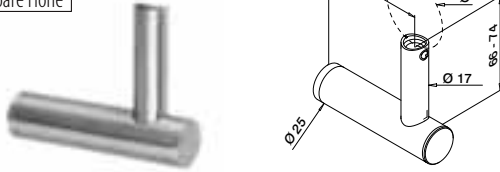

MOD 0147

V2A	304	Gebürstet			
	INDOOR*	Ø			
SELL OUT	130147-044	42,4 / 48,3	QS-21	472 / QS-25	472 2
V4A	316	Gebürstet			
	OUTDOOR				
SELL OUT	140147-044	42,4 / 48,3	QS-22	472 / QS-71	472 2



Internationaler Geschmacksmusterschutz

Für rundes Rohr
Einstellbare Höhe

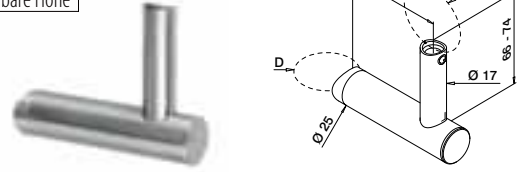

MOD 0143

V2A	304	Gebürstet			
	INDOOR*	D Ø			
SELL OUT	130143-044-12	42,4 42,4 / 48,3	QS-21	472 / QS-25	472 2

MOD 0144

V2A	304	Gebürstet			
	INDOOR*	D Ø			
SELL OUT	130144-044-12	48,3 42,4 / 48,3	QS-21	472 / QS-25	472 2



Internationaler Geschmacksmusterschutz

Für rundes Rohr

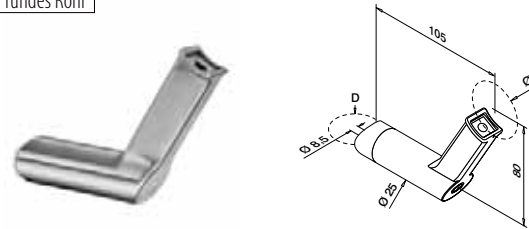

MOD 9330

V2A	304	Gebürstet			
	INDOOR*	D Ø			
SELL OUT	139330-042	42,4 42,4	QS-21	472 / QS-25	472 2



* Auch für Aussenanwendung geeignet bei entsprechenden Bedingungen.

SELL OUT Nur solange der Vorrat reicht.

Q-INFO MOD 0147 / 0143 / 0144

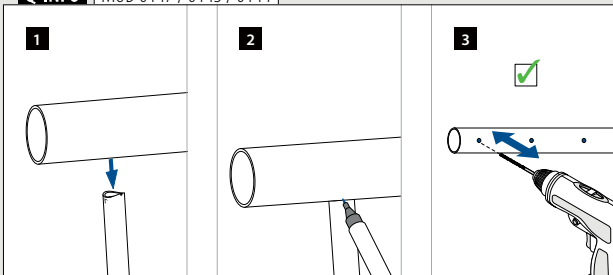

Q-INFO MOD 9330

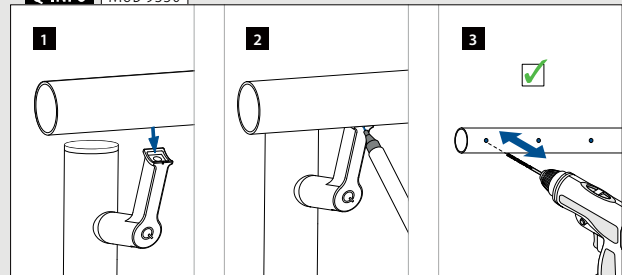

Q-INFO MOD 0147 / 0143 / 0144

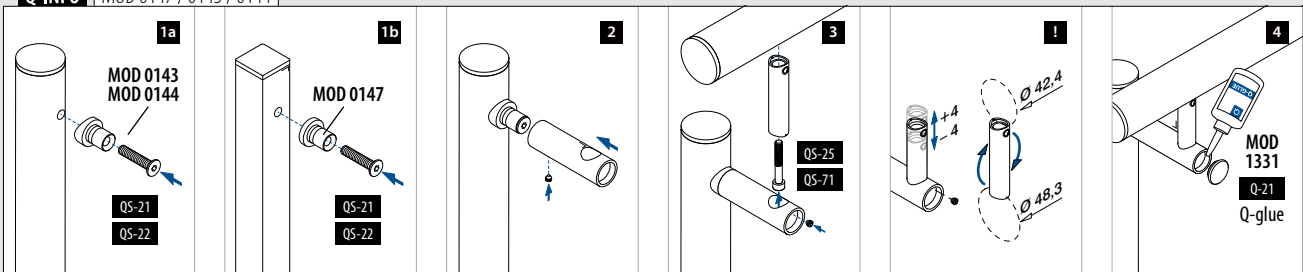

Für flaches Rohr
Einstellbare Höhe

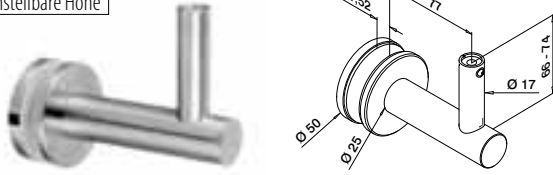

MOD 0148

V2A	304	Gebürstet		
INDOOR*				
SELL OUT	130148-000-12	QS-24	472	2



Internationaler Geschmacksmusterschutz

Für rundes Rohr
Einstellbare Höhe

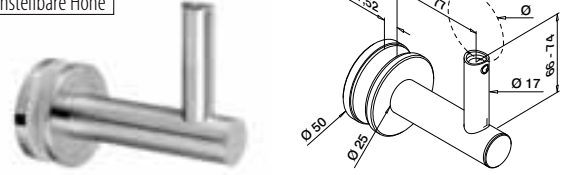

MOD 0148

V2A	304	Gebürstet		
INDOOR*				
SELL OUT	130148-044-12	42,4 / 48,3	QS-25	472

V4A	316	Gebürstet		
OUTDOOR				
SELL OUT	140148-044-12	42,4 / 48,3	QS-71	472



Internationaler Geschmacksmusterschutz

Für rundes Rohr

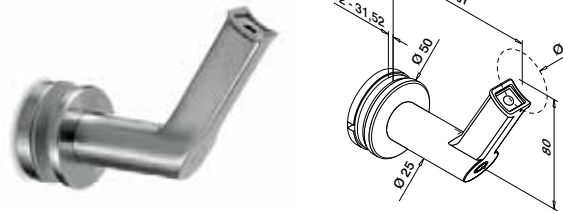

MOD 9350

V2A	304	Gebürstet		
INDOOR*				
		Ø		
	139350-042	42,4	QS-25	472
	139350-048	48,3	QS-25	472

V4A	316	Gebürstet		
OUTDOOR				
SELL OUT	149350-042	42,4	QS-71	472
SELL OUT	149350-048	48,3	QS-71	472



* Auch für Aussenanwendung geeignet bei entsprechenden Bedingungen.

SELL OUT Nur solange der Vorrat reicht.

Q-INFO MOD 0148-044

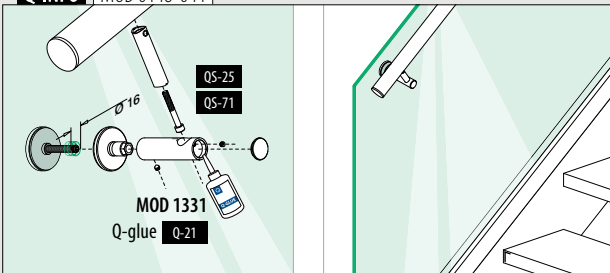

Q-INFO MOD 9350

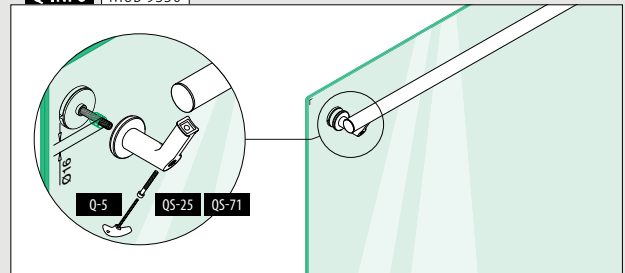

Q-INFO MOD 0148-044

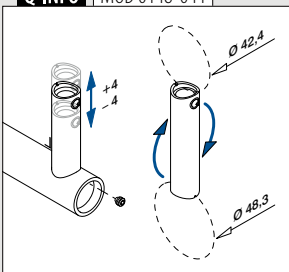

Q-INFO MOD 0148-044

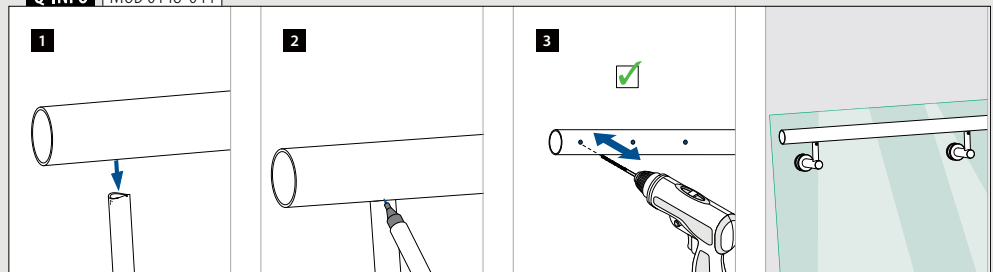

Für flaches Rohr

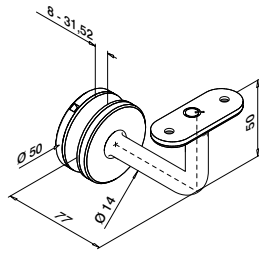

MOD 0117

V2A	304	Gebürstet		
INDOOR*				
130117-000-12	QS-12	472	2	
V4A	316	Gebürstet		
OUTDOOR				
140117-000-12	QS-13	472	2	



Für rundes Rohr

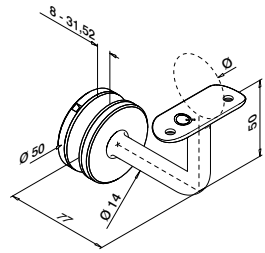

MOD 0117

V2A	304	Gebürstet		
INDOOR*				
130117-033-12	33,7	QS-10	472	2
130117-042-12	42,4	QS-10	472	2
130117-048-12	48,3	QS-10	472	2
V4A	316	Gebürstet		
OUTDOOR				
140117-042-12	42,4	QS-11	472	2
140117-048-12	48,3	QS-11	472	2
V4A	316	Hochglanzpoliert		
OUTDOOR				
140117-042-10	42,4	QS-11	472	2
140117-048-10	48,3	QS-11	472	2



Für flaches Rohr

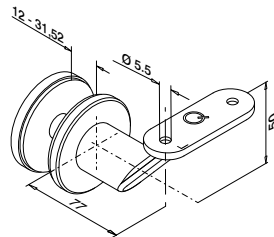

MOD 0129

V2A	304	Gebürstet		
INDOOR*				
130129-000-12	QS-12	472	2	
V4A	316	Gebürstet		
OUTDOOR				
140129-000-12	QS-13	472	2	



Für rundes Rohr

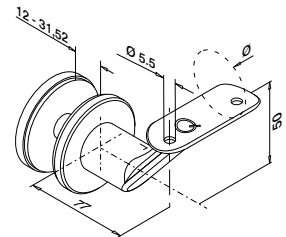

MOD 0129

V2A	304	Gebürstet		
INDOOR*				
130129-042-12	42,4	QS-10	472	2
130129-048-12	48,3	QS-10	472	2
V4A	316	Gebürstet		
OUTDOOR				
140129-042-12	42,4	QS-11	472	2
140129-048-12	48,3	QS-11	472	2



Q-INFO MOD 0117

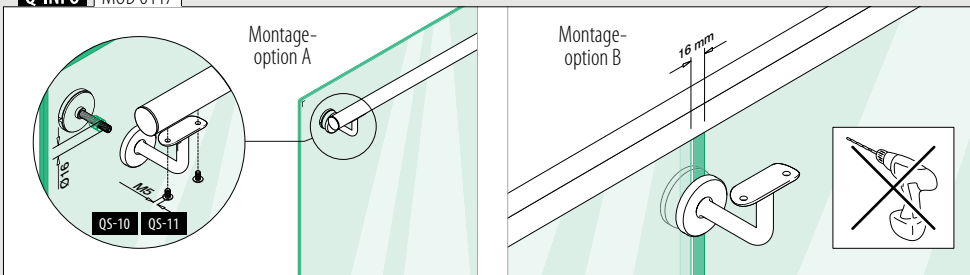

Q-INFO 316



Q-INFO MOD 0129

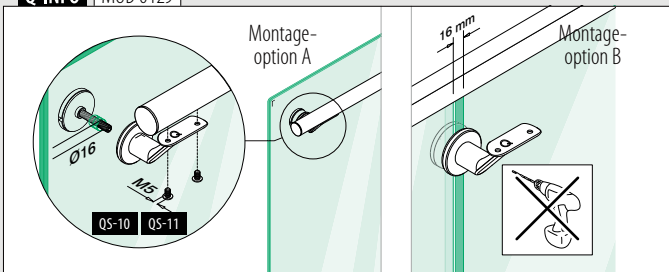

Q-INFO

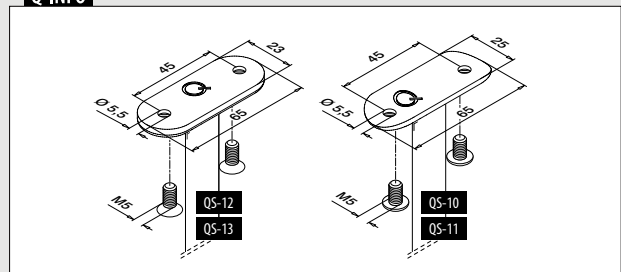

Für flaches Rohr

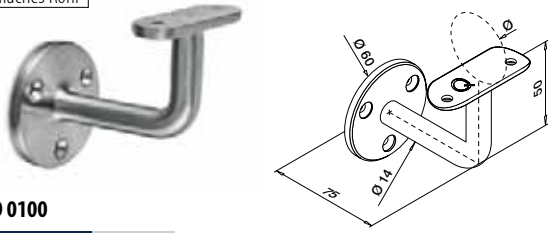

MOD 0100

V2A	304	Gebürstet			
INDOOR*					
130100-000-12	QS-7	471 / QS-12	472 / QS-87	470 2	
V2A	304	Black Line			
INDOOR					
NEW	130100-000-82	QS-7	471 / QS-12	472 / QS-87	470 2
V4A	316	Gebürstet			
OUTDOOR					
140100-000-12	QS-50	471 / QS-13	472 / QS-87	470 2	



Für rundes Rohr

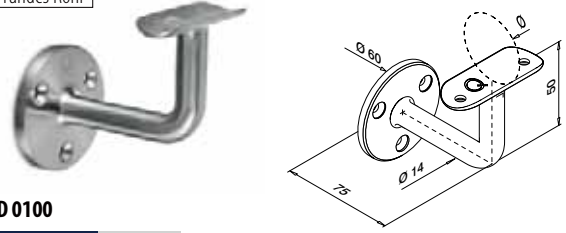

MOD 0100

V2A	304	Gebürstet			
INDOOR*					
130100-042-12	42,4	QS-7	471 / QS-10	472 / QS-87	470 2
130100-048-12	48,3	QS-7	471 / QS-10	472 / QS-87	470 2
V4A	316	Gebürstet			
OUTDOOR					
140100-042-12	42,4	QS-50	471 / QS-11	472 / QS-87	470 2
140100-048-12	48,3	QS-50	471 / QS-11	472 / QS-87	470 2



Für flaches Rohr

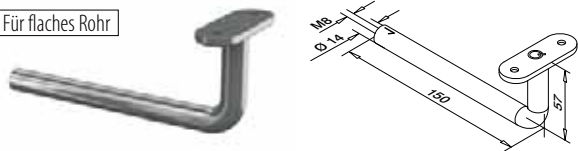

MOD 0809

V2A	304	Gebürstet		
INDOOR*				
130809-000-12	QS-12	472		2
V4A	316	Gebürstet		
OUTDOOR				
140809-000-12	QS-13	472		2



Für rundes Rohr

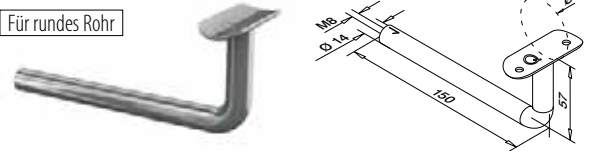

MOD 0809

V2A	304	Gebürstet		
INDOOR*				
130809-042-12	42,4	QS-10	472	2
130809-048-12	48,3	QS-10	472	2
V4A	316	Gebürstet		
OUTDOOR				
140809-042-12	42,4	QS-11	472	2
140809-048-12	48,3	QS-11	472	2



Flansche für Handlaufstützen MOD 0809



MOD 1938

V2A	304	Gebürstet		
INDOOR*				
131938-12	QS-7	471		2
V4A	316	Gebürstet		
OUTDOOR				
141938-12	QS-50	471		2



MOD 0100
Mit Kabelkanal
260

Q-INFO MOD 0100 / 0809

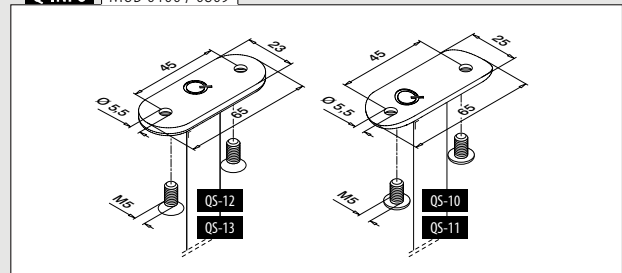

Q-INFO MOD 0809 / 1938

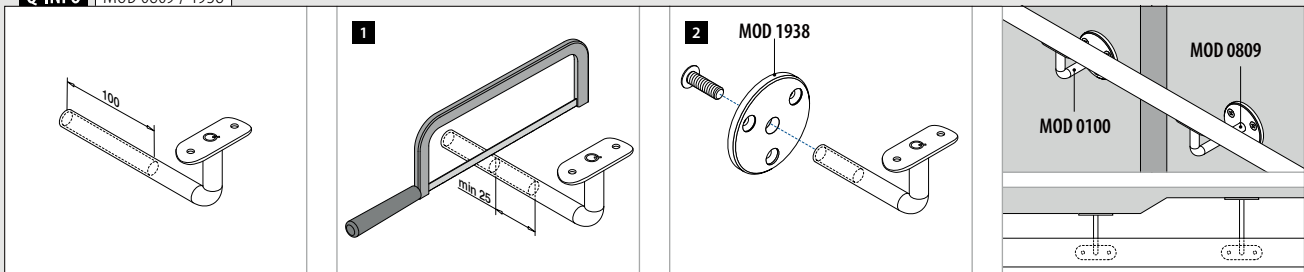

Für flaches Rohr

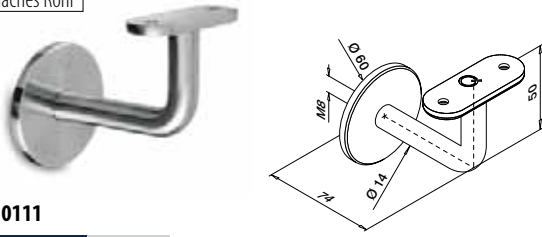

MOD 0111

V2A	304	Gebürstet		
INDOOR*				
130111-000-12		QS-12	472	2
V4A	316	Gebürstet		
OUTDOOR				
140111-000-12		QS-13	472	2



Für rundes Rohr

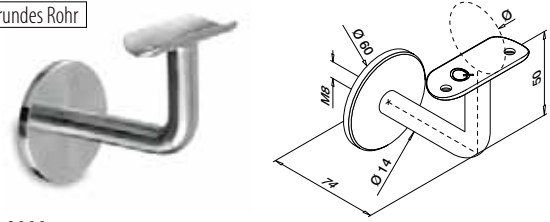

MOD 0111

V2A	304	Gebürstet			
INDOOR*					
130111-033-12	33,7	QS-10	472	2	
130111-042-12	42,4	QS-10	472	2	
130111-048-12	48,3	QS-10	472	2	
V2A	304	Hochglanzpoliert			
INDOOR*					
SELL OUT	130111-042-10	42,4	QS-10	472	2
V2A	304	Black Line			
INDOOR					
NEW	130111-042-82	42,4	QS-10	472	2
V4A	316	Gebürstet			
OUTDOOR					
140111-042-12	42,4	QS-11	472	2	
140111-048-12	48,3	QS-11	472	2	
V4A	316	Hochglanzpoliert			
OUTDOOR					
140111-042-10	42,4	QS-11	472	2	



* Auch für Aussenanwendung geeignet bei entsprechenden Bedingungen.

SELL OUT Nur solange der Vorrat reicht.

Q-INFO

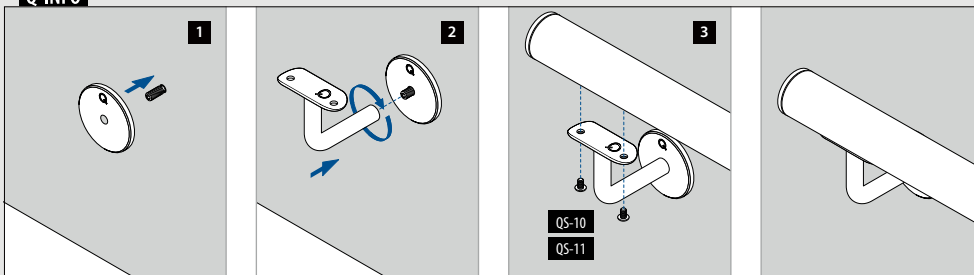

Q-INFO

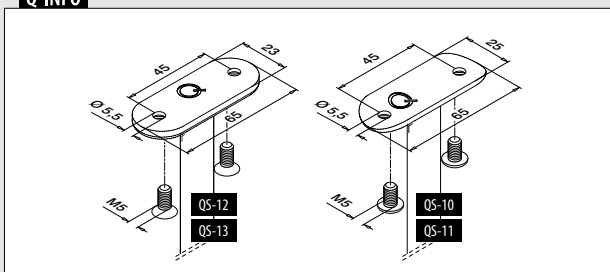

Q-INFO 316 304



Für rundes Rohr

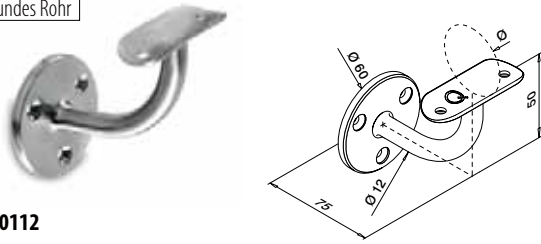

MOD 0112

V2A	304	Gebürstet				
INDOOR*						
130112-033-12	33,7	QS-7	471 / QS-10	472 / QS-87	470	2
130112-042-12	42,4	QS-7	471 / QS-10	472 / QS-87	470	2
130112-048-12	48,3	QS-7	471 / QS-10	472 / QS-87	470	2
V2A	304	Hochglanzpoliert				
INDOOR*						
130112-042-10	42,4	QS-7	471 / QS-10	472 / QS-87	470	2
V4A	316	Gebürstet				
OUTDOOR						
140112-042-12	42,4	QS-50	471 / QS-11	472 / QS-87	470	2
V4A	316	Hochglanzpoliert				
OUTDOOR						
140112-042-10	42,4	QS-50	471 / QS-11	472 / QS-87	470	2
Zinkdruckguss Edelstahl-effekt						
INDOOR						
100112-042	42,4	QS-7	471 / QS-10	472 / QS-87	470	2



Für rundes Rohr

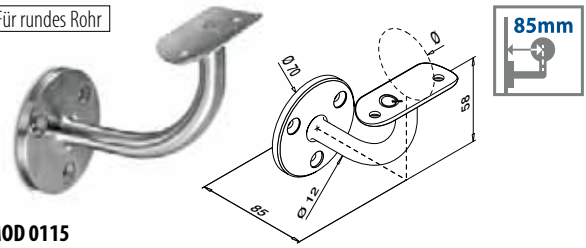

MOD 0115

V2A	304	Gebürstet				
INDOOR*						
130115	42,4	QS-7	471 / QS-10	472 / QS-87	470	2



Für flaches Rohr

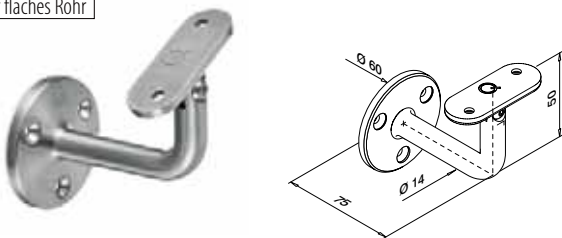

MOD 0102

V2A	304	Gebürstet				
INDOOR*						
130102-000-12		QS-7	471 / QS-12	472 / QS-87	470	2



Für rundes Rohr

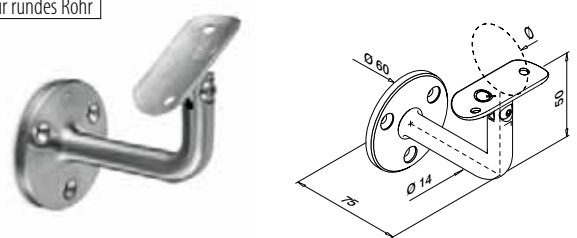

MOD 0102

V2A	304	Gebürstet				
INDOOR*						
130102-042-12	42,4	QS-7	471 / QS-10	472 / QS-87	470	2
130102-048-12	48,3	QS-7	471 / QS-10	472 / QS-87	470	2

V4A	316	Gebürstet				
OUTDOOR						
140102-042-12	42,4	QS-50	471 / QS-11	472 / QS-87	470	2
140102-048-12	48,3	QS-50	471 / QS-11	472 / QS-87	470	2



Q-INFO

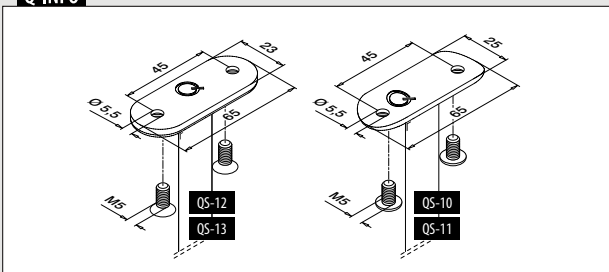

Q-INFO 304 316



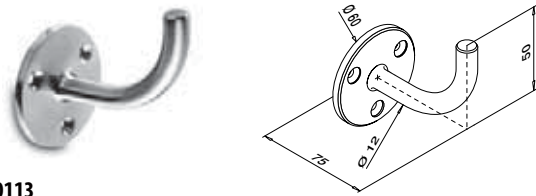

MOD 0113

V2A	304	Gebürstet		
INDOOR*				
130113	QS-7	471 / QS-87	470	2

V4A	316	Gebürstet		
OUTDOOR				
140113	QS-50	471 / QS-87	470	2

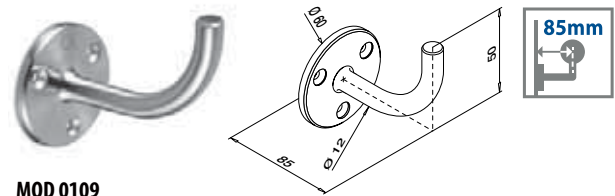

MOD 0109

V2A	304	Gebürstet		
INDOOR*				
130109	QS-7	471 / QS-87	470	2

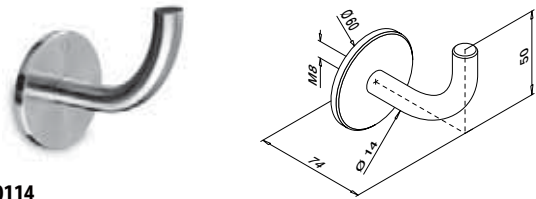

MOD 0114

V2A	304	Gebürstet		
INDOOR*				
SELL OUT 130114	QS-1	471		2

V4A	316	Gebürstet		
OUTDOOR				
SELL OUT 140114	QS-2	471		2

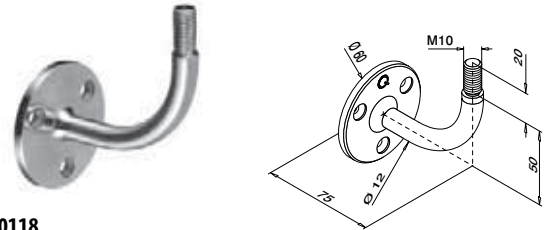

MOD 0118

V2A	304	Gebürstet		
INDOOR*				
130118	QS-7	471 / QS-87	470	2



MOD 0519

V4A	316	Gebürstet		
OUTDOOR				
140519				2

Zinkdruckguss Edelstahleffekt				
INDOOR				
SELL OUT 100519				2

* Auch für Aussenanwendung geeignet bei entsprechenden Bedingungen.

SELL OUT Nur solange der Vorrat reicht.

Q-INFO | MOD 0118

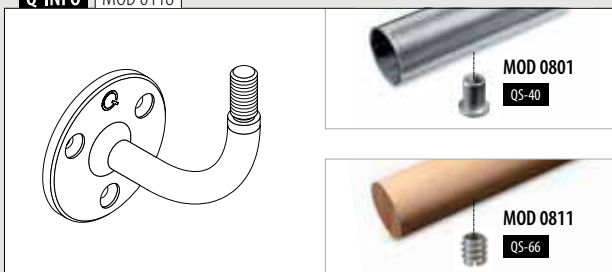

Q-INFO | MOD 0519

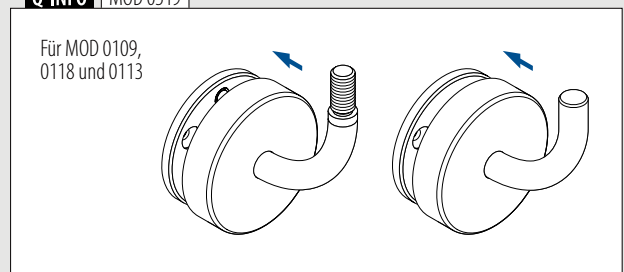

Für flaches Rohr

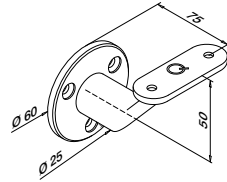

Für rundes Rohr

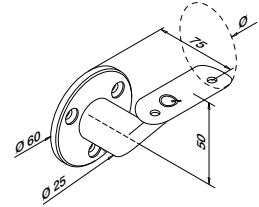

MOD 0126

V2A	304	Gebürstet		
INDOOR*				
130126-000-12		QS-12	472	2
V4A	316	Gebürstet		
OUTDOOR				
140126-000-12		QS-13	472	2



Internationaler Geschmacksmusterschutz

MOD 0126

V2A	304	Gebürstet		
INDOOR*				
130126-042-12	42,4	QS-10	472	2
130126-048-12	48,3	QS-10	472	2
V4A	316	Gebürstet		
OUTDOOR				
140126-042-12	42,4	QS-11	472	2

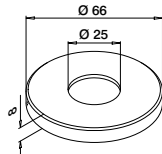

MOD 0520

V2A	304	Gebürstet		
INDOOR*				
130520-12				2
V4A	316	Gebürstet		
OUTDOOR				
140520-12				2

* Auch für Aussenanwendung geeignet bei entsprechenden Bedingungen.

Q-INFO | MOD 0126

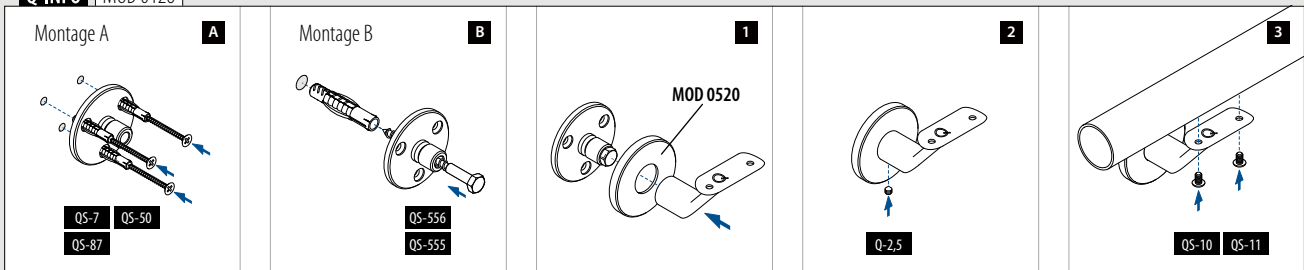

Für rundes Rohr

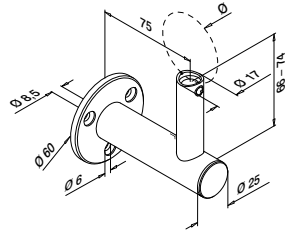

MOD 0142

V2A	304	Gebürstet			
	INDOOR*		Ø		
SELL OUT	130142-044-12	42,4 / 48,3		QS-25	472
					2
V4A	316	Gebürstet			
	OUTDOOR		Ø		
SELL OUT	140142-044-12	42,4 / 48,3		QS-71	472
					2

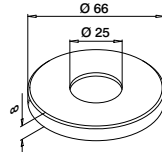

MOD 0520

V2A	304	Gebürstet			
	INDOOR*				
	130520-12				2
V4A	316	Gebürstet			
	OUTDOOR				
	140520-12				2

Q-INFO MOD 0142

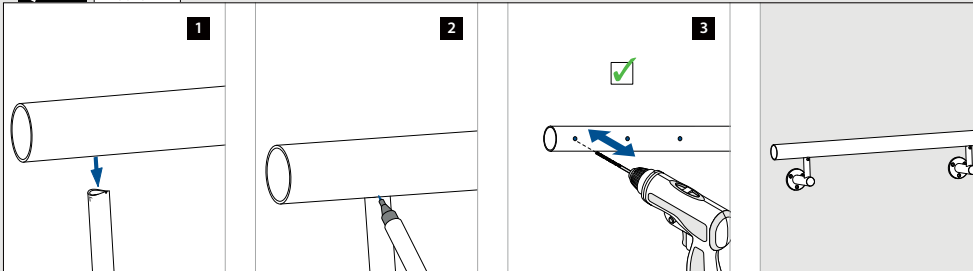

Q-INFO MOD 0520

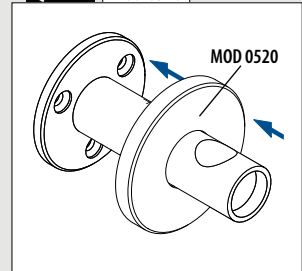

Q-INFO MOD 0142

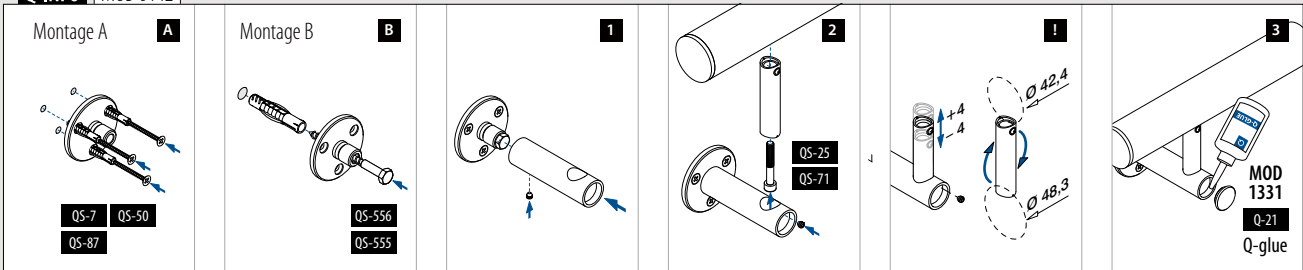

Für rundes Rohr



MOD 0110

V4A	316	Gebürstet		
	OUTDOOR	Ø		
140110	42,4	QS-11	472	2



Internationaler Geschmacksmusterschutz

Für rundes Rohr

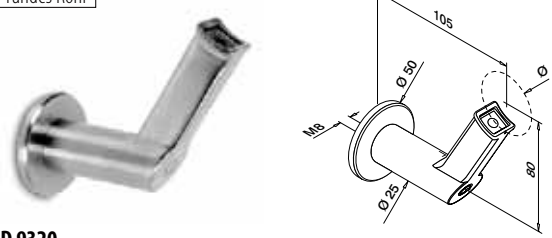

MOD 9320

V2A	304	Gebürstet		
	INDOOR*	Ø		
139320-042	42,4	QS-1	471 / QS-25	472
				2



MOD 0509

V4A	316	Gebürstet		
	OUTDOOR			
140509				2

Internationaler Geschmacksmusterschutz

Q-INFO MOD 9320

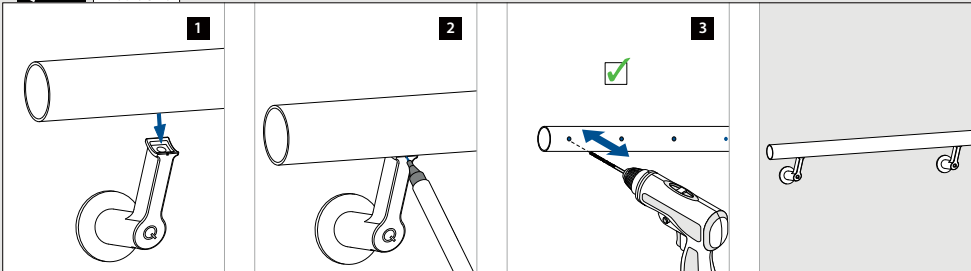

Q-INFO MOD 0110 / 0509

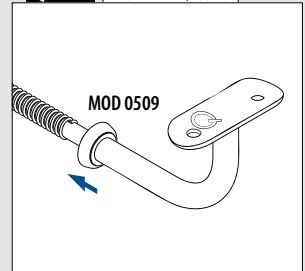

Q-INFO MOD 9320

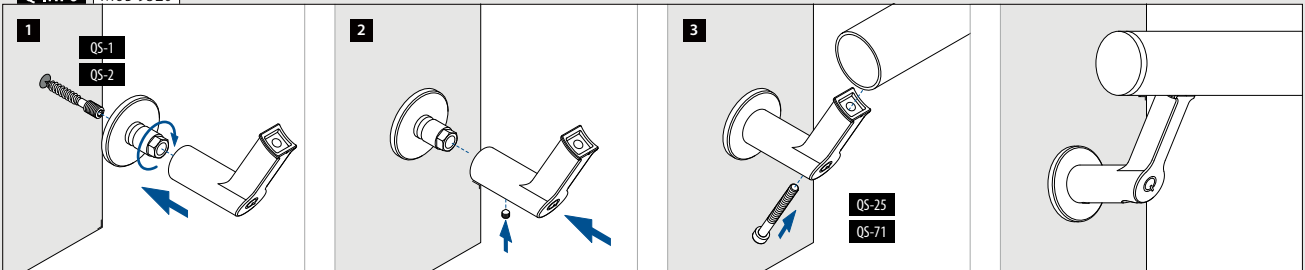

Für flaches Rohr

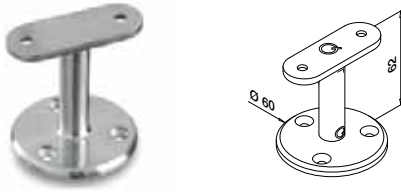

MOD 0708

V2A	304	Gebürstet		
INDOOR*				
130708-000-12	QS-5	471 / QS-12	472	2



Für rundes Rohr

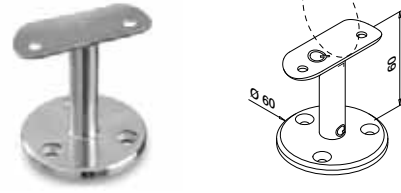

MOD 0708

V2A	304	Gebürstet		
INDOOR*				
130708-042-12	42,4	QS-5	471 / QS-10	472
130708-048-12	48,3	QS-5	471 / QS-10	472

V4A	316	Gebürstet		
OUTDOOR				
140708-042-12	42,4	QS-6	471 / QS-11	472
140708-048-12	48,3	QS-6	471 / QS-11	472



für rundes Rohr zu flachem Rohr

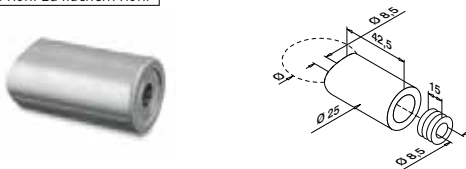

MOD 0625

V2A	304	Gebürstet		
INDOOR*				
130625-033-12	33,7	QS-3	471 / QS-29	472
130625-042-12	42,4	QS-3	471 / QS-29	472

V4A	316	Gebürstet		
OUTDOOR				
140625-042-12	42,4	QS-4	471 / QS-30	472



Für rundes Rohr



MOD 0627

V2A	304	Gebürstet		
INDOOR*				
130627-042-12	42,4	42,4	QS-29	472



Q-INFO MOD 0708

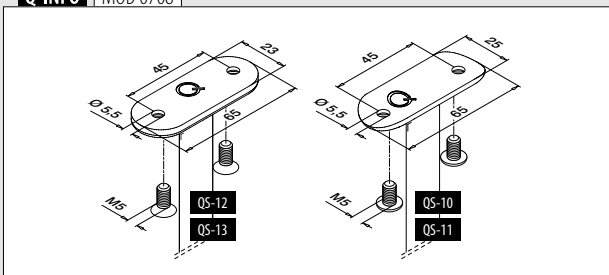

* Auch für Aussenanwendung geeignet bei entsprechenden Bedingungen.

Q-INFO MOD 0625

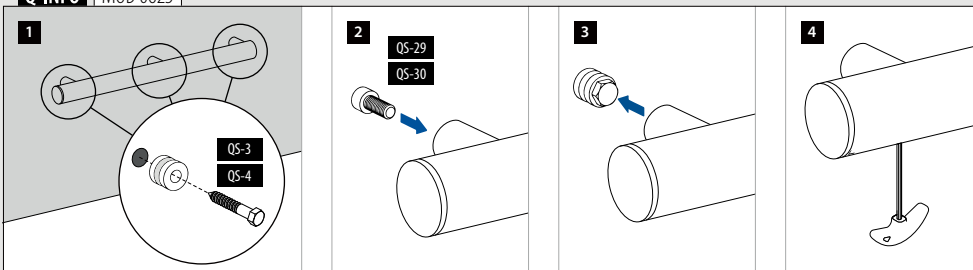

Q-INFO MOD 0627

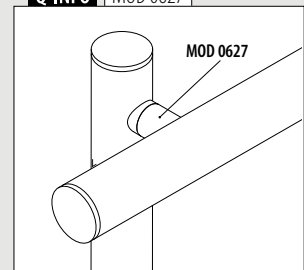



Q-TUBE

EDELSTAHLROHRE VON Q-RAILING

NIEDRIGE TOLERANZEN
UND MAKELLOSE OBERFLÄCHEN.

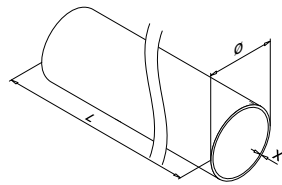
**MOD 0900**

Ø 33,7 mm

V2A	304	Gebürstet	
	INDOOR*	X	
	130900-233-50-12	2,0	L = 5 m
V4A	316	Gebürstet	
	OUTDOOR		
	140900-233-50-12	2,0	L = 5 m

Ø 42,4 mm

V2A	304	Gebürstet	
	INDOOR*	X	
SELL OUT	130900-242-25-12	2,0	L = 2,5 m
	130900-242-50-12	2,0	L = 5 m
SELL OUT	130900-042-50-12	2,6	L = 5 m
V2A	304	Hochglanzpoliert	
	INDOOR*		
SELL OUT	130900-242-50-10	2,0	L = 5 m
V2A	304	Black Line	
	INDOOR		
NEW	130900-242-50-82	2,0	L = 5 m
V4A	316	Gebürstet	
	OUTDOOR		
	140900-242-25-12	2,0	L = 2,5 m
	140900-242-50-12	2,0	L = 5 m
SELL OUT	140900-042-50-12	2,6	L = 5 m
V4A	316	Hochglanzpoliert	
	OUTDOOR		
	140900-242-50-10	2,0	L = 5 m

Ø 48,3 mm

V2A	304	Gebürstet	
	INDOOR*	X	
	130900-248-25-12	2,0	L = 2,5 m
	130900-248-50-12	2,0	L = 5 m
	130900-048-50-12	2,6	L = 5 m
V4A	316	Gebürstet	
	OUTDOOR		
	140900-248-25-12	2,0	L = 2,5 m
	140900-248-50-12	2,0	L = 5 m
SELL OUT	140900-048-25-12	2,6	L = 2,5 m
	140900-048-50-12	2,6	L = 5 m

Ø 60,3 mm

V2A	304	Gebürstet	
	INDOOR*	X	
SELL OUT	130900-060-50-12	2,0	L = 5 m

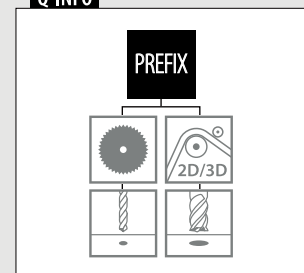
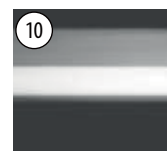

* Auch für Aussenanwendung geeignet bei entsprechenden Bedingungen.

SELL OUT Nur solange der Vorrat reicht.**Q-INFO****Q-INFO** 316 304

Hochglanzpoliert

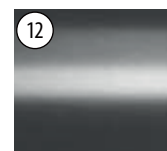

Gebürstet



Schwarz, matt, strukturiert

Q-INFO**Sparen Sie Zeit und Geld mit Q-tube**

Q-tube hat eine viel niedrigere Toleranz als standardmässige Rohre. Auch die Schweissnaht des Q-tubes ist speziell unseren Fittings angepasst. Die Fittings passen dadurch perfekt in unsere Rohre, damit Sie schnell und effektiv arbeiten können. Um die Qualität zu gewährleisten und Beschädigungen zu vermeiden wird jede Rohrlänge separat verpackt.

Verbinder



MOD 5792 - EASY HIT®

V2A	304	Roh		
INDOOR*			Für Rohr Ø	
SELL OUT	135792-242		42,4 x 2,0	2
SELL OUT	135792-042		42,4 x 2,6	2
SELL OUT	135792-248		48,3 x 2,0	2
V4A	316	Roh		
OUTDOOR				
	145792-233		33,7 x 2,0	2
	145792-242		42,4 x 2,0	2
SELL OUT	145792-042		42,4 x 2,6	2
	145792-248		48,3 x 2,0	2
	145792-048		48,3 x 2,6	2



Internationaler Geschmacksmusterschutz



MOD 0790

V2A	304	Gebürstet		
INDOOR*			Für Rohr Ø	
	130790-233-12		33,7 x 2,0	2
	130790-242-12		42,4 x 2,0	2
SELL OUT	130790-042-12		42,4 x 2,6	2
	130790-248-12		48,3 x 2,0	2
	130790-048-12		48,3 x 2,6	2
V4A	316	Gebürstet		
OUTDOOR				
	140790-242-12		42,4 x 2,0	2
SELL OUT	140790-042-12		42,4 x 2,6	2
	140790-248-12		48,3 x 2,0	2



Rohrbögen



MOD 0903

V2A	304	Gebürstet		
INDOOR*			Ø	R
	130903-242-12		42,4 x 2,0	85
	130903-248-12		48,3 x 2,0	97

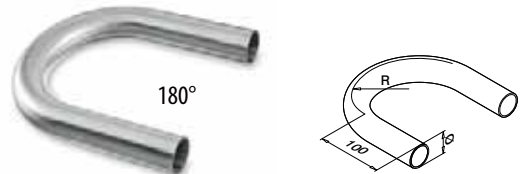

MOD 0906

V2A	304	Gebürstet		
INDOOR*			Ø	R
	130906-242-12		42,4 x 2,0	85
	130906-248-12		48,3 x 2,0	97
V4A	316	Gebürstet		
OUTDOOR				
	140906-242-12		42,4 x 2,0	85
	140906-248-12		48,3 x 2,0	97

Q-INFO | MOD 5792

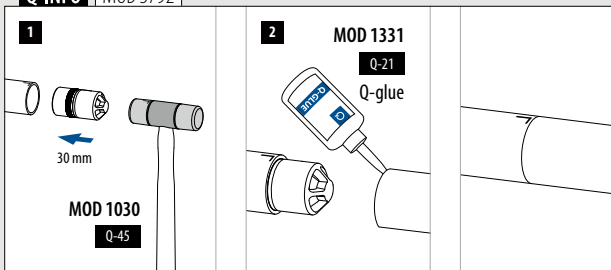

* Auch für Aussenanwendung geeignet bei entsprechenden Bedingungen.



Nur solange der Vorrat reicht.

Verbinder

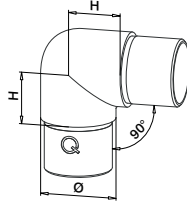

MOD 0303

V2A	304	Gebürstet			
INDOOR*		Für Rohr Ø	H		
	130303-233-12	33,7 x 2,0	25	2	
	130303-242-12	42,4 x 2,0	30	2	
SELL OUT	130303-042-12	42,4 x 2,6	30	2	
	130303-248-12	48,3 x 2,0	35	2	
	130303-048-12	48,3 x 2,6	35	2	
SELL OUT	130303-060-12	60,3 x 2,0	40	2	
V4A	316	Gebürstet			
OUTDOOR		Für Rohr Ø	H		
	140303-242-12	42,4 x 2,0	30	2	
SELL OUT	140303-042-12	42,4 x 2,6	30	2	
	140303-248-12	48,3 x 2,0	35	2	
	140303-048-12	48,3 x 2,6	35	2	
V4A	316	Hochglanzpoliert			
OUTDOOR		Für Rohr Ø	H		
	140303-242-10	42,4 x 2,0	30	2	



Kombinierbar mit 90° MOD 0710, 0810 und 4710 Handlaufstützen.

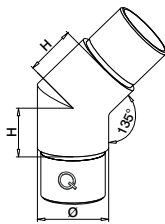

MOD 0300

V2A	304	Gebürstet			
INDOOR*		Für Rohr Ø	H		
	130300-242-12	42,4 x 2,0	30	2	
SELL OUT	130300-042-12	42,4 x 2,6	30	2	
SELL OUT	130300-248-12	48,3 x 2,0	35	2	
V4A	316	Gebürstet			
OUTDOOR		Für Rohr Ø	H		
	140300-242-12	42,4 x 2,0	30	2	
	140300-248-12	48,3 x 2,0	35	2	



MOD 0305

V2A	304	Gebürstet			
INDOOR*		Für Rohr Ø	H		
	130305-233-12	33,7 x 2,0	25	2	
	130305-242-12	42,4 x 2,0	30	2	
	130305-248-12	48,3 x 2,0	35	2	
V4A	316	Gebürstet			
OUTDOOR		Für Rohr Ø	H		
	140305-242-12	42,4 x 2,0	30	2	
SELL OUT	140305-042-12	42,4 x 2,6	30	2	
	140305-248-12	48,3 x 2,0	35	2	
	140305-048-12	48,3 x 2,6	35	2	



Kombinierbar mit MOD 1820 Handlauf-Anschlussplatten.
Nicht kombinierbar mit MOD 0710, 0810 und 4710 Handlaufstützen.

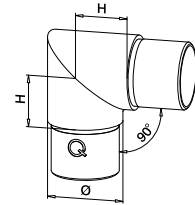

MOD 0301

V2A	304	Gebürstet			
INDOOR*		Für Rohr Ø	H		
SELL OUT	130301-233-12	33,7 x 2,0	25	2	
SELL OUT	130301-242-12	42,4 x 2,0	30	2	
V4A	316	Gebürstet			
OUTDOOR		Für Rohr Ø	H		
SELL OUT	140301-242-12	42,4 x 2,0	30	2	
SELL OUT	140301-248-12	48,3 x 2,0	35	2	



Nicht kombinierbar mit 90° MOD 0710, 0810 und 4710 Handlaufstützen.



MOD 1820
337



MOD 0710
325



MOD 0810
335



MOD 4710
294

Q-INFO | 304 | 316

10



Hochglanz-
poliert

12



Gebürstet

Verbinder

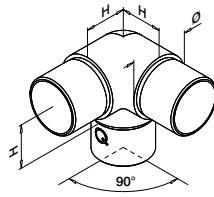

MOD 0304

V2A	304	Gebürstet	INDOOR*	Für Rohr Ø	H	
SELL OUT	130304-233-12			33,7 x 2,0	25	2
	130304-242-12			42,4 x 2,0	30	2
	130304-248-12			48,3 x 2,0	35	2

V4A	316	Gebürstet	OUTDOOR	Für Rohr Ø	H	
	140304-242-12			42,4 x 2,0	30	2
SELL OUT	140304-042-12			42,4 x 2,6	30	2
	140304-248-12			48,3 x 2,0	35	2
SELL OUT	140304-048-12			48,3 x 2,6	35	2

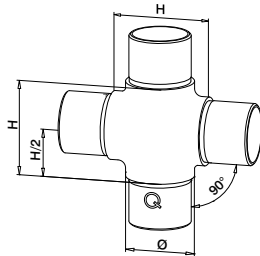

MOD 0309

V2A	304	Gebürstet	INDOOR*	Für Rohr Ø	H	H/2	
	130309-242-12			42,4 x 2,0	60	30	2

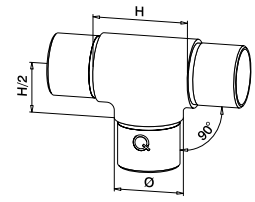

MOD 0307

V2A	304	Gebürstet	INDOOR*	Für Rohr Ø	H	H/2	
	130307-233-12			33,7 x 2,0	50	25	2
	130307-242-12			42,4 x 2,0	60	30	2
	130307-248-12			48,3 x 2,0	70	35	2

V4A	316	Gebürstet	OUTDOOR	Für Rohr Ø	H	H/2	
	140307-242-12			42,4 x 2,0	60	30	2
	140307-248-12			48,3 x 2,0	70	35	2
	140307-048-12			48,3 x 2,6	70	35	2

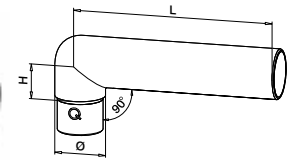

MOD 0306

V2A	304	Gebürstet	INDOOR*	Für Rohr Ø	H	L	
	130306-233			33,7 x 2,0	25	223	2
	130306-242			42,4 x 2,0	30	228	2



Q-INFO MOD 0306

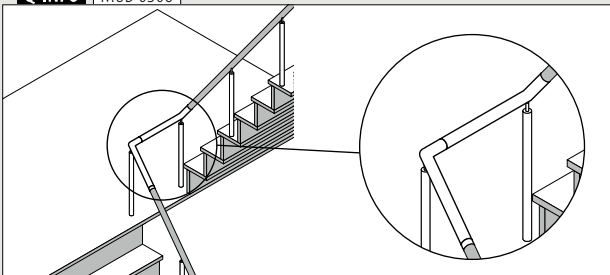

Q-INFO

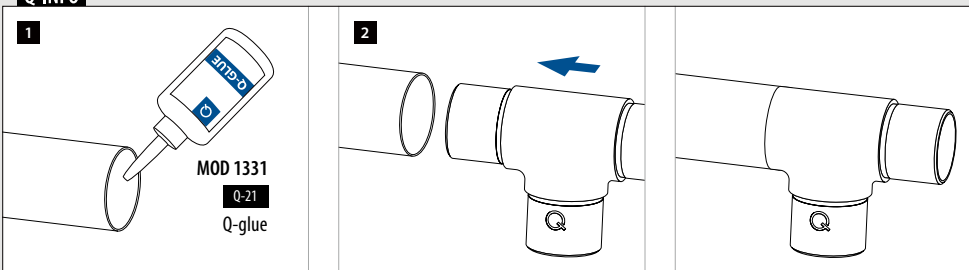

MOD 1331
Q-21
Q-glue

* Auch für Aussenanwendung geeignet bei entsprechenden Bedingungen.

SELL OUT Nur solange der Vorrat reicht.

Aufwärts rechts
Abwärts links

0 - 70°

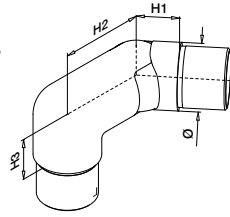

MOD 0317

V2A	304	Gebürstet	INDOOR*	Für Rohr Ø	H1	H2	H3	
130317-242-01				42,4 x 2,0	27	60	30	2
130317-248-01				48,3 x 2,0	30	65	35	2

Aufwärts links
Abwärts rechts

0 - 70°

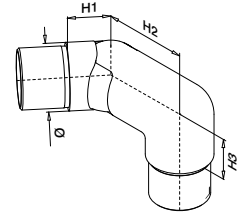

MOD 0317

V2A	304	Gebürstet	INDOOR*	Für Rohr Ø	H1	H2	H3	
130317-242-02				42,4 x 2,0	27	60	30	2
130317-248-02				48,3 x 2,0	30	65	35	2



0 - 90°

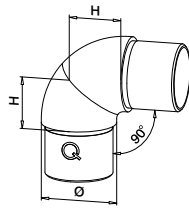

MOD 0791

V2A	304	Gebürstet	INDOOR*	Für Rohr Ø	H	
130791-242-12				42,4 x 2,0	30	2
130791-248-12				48,3 x 2,0	35	2

V4A	316	Gebürstet	OUTDOOR	Für Rohr Ø	H	
140791-242-12				42,4 x 2,0	30	2

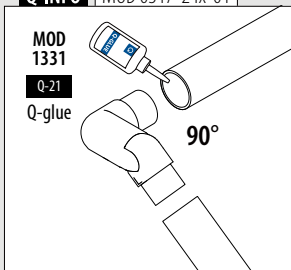

Q-INFO MOD 0317-24x-01

MOD 1331
Q-21
Q-glue

Q-INFO MOD 0317-24x-02

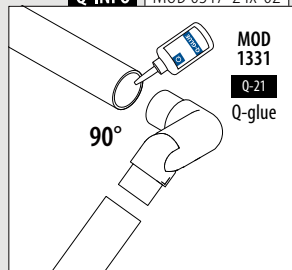
MOD 1331
Q-21
Q-glue



-90°
+90°

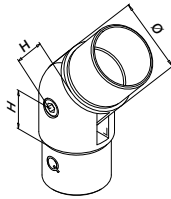

MOD 0302

V2A	304	Gebürstet			
INDOOR*		Für Rohr Ø	H		
130302-233-12	33,7 x 2,0	22	2		
130302-242-12	42,4 x 2,0	27	2		
130302-248-12	48,3 x 2,0	30	2		

V4A	316	Gebürstet			
OUTDOOR					
SELL OUT	140302-233-12	33,7 x 2,0	27	2	
	140302-242-12	42,4 x 2,0	27	2	
	140302-248-12	48,3 x 2,0	30	2	



0 - 70°

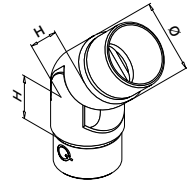

MOD 0312

V2A	304	Gebürstet			
INDOOR*		Für Rohr Ø	H		
	130312-233-12	33,7 x 2,0	22	2	
	130312-242-12	42,4 x 2,0	27	2	
SELL OUT	130312-042-12	42,4 x 2,6	27	2	
	130312-248-12	48,3 x 2,0	30	2	
	130312-048-12	48,3 x 2,6	30	2	

V4A	316	Gebürstet			
OUTDOOR					
	140312-242-12	42,4 x 2,0	27	2	
SELL OUT	140312-042-12	42,4 x 2,6	27	2	
	140312-248-12	48,3 x 2,0	30	2	
	140312-048-12	48,3 x 2,6	30	2	
SELL OUT	140312-060-12	60,3 x 2,0	33	2	

V4A	316	Hochglanzpoliert			
OUTDOOR					
	140312-242-10	42,4 x 2,0	27	2	



Internationaler Geschmacksmusterschutz

MOD 0319

V4A	316	Gebürstet			
OUTDOOR		Für Rohr Ø	H1	H2	
	140319-242-12	42,4 x 2,0	27	35	2
	140319-248-12	48,3 x 2,0	30	40	2



Internationaler Geschmacksmusterschutz

* Auch für Aussenanwendung geeignet bei entsprechenden Bedingungen.

SELL OUT Nur solange der Vorrat reicht.

Q-INFO | MOD 0312 / 0319

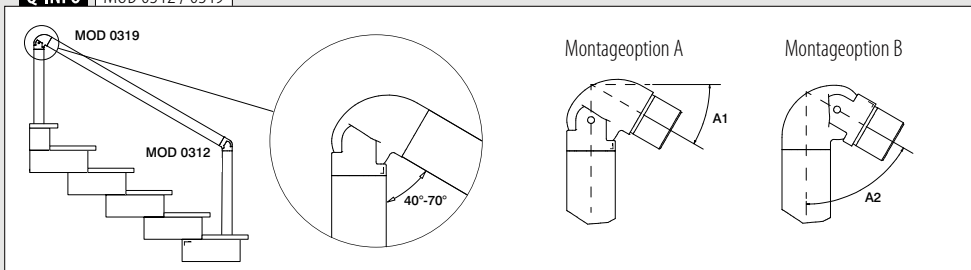

Q-INFO | 304 | 316

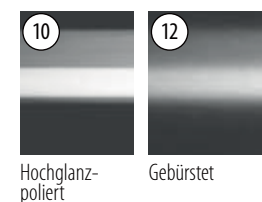

Endkappen

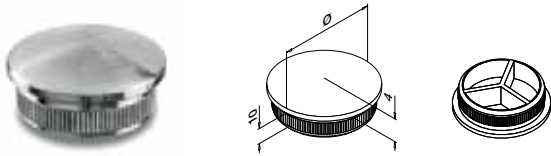

MOD 5729 - EASY HIT®

V2A	304	Gebürstet		
INDOOR*				
			Für Rohr Ø	
	135729-233-12		33,7 x 2,0	2
	135729-242-12		42,4 x 2,0	2
SELL OUT	135729-042-12		42,4 x 2,6	2
	135729-248-12		48,3 x 2,0	2
	135729-048-12		48,3 x 2,6	2
SELL OUT	135729-060-12		60,3 x 2,0	2
V4A	316	Gebürstet		
OUTDOOR				
	145729-233-12		33,7 x 2,0	2
	145729-242-12		42,4 x 2,0	2
SELL OUT	145729-042-12		42,4 x 2,6	2
	145729-248-12		48,3 x 2,0	2
	145729-048-12		48,3 x 2,6	2

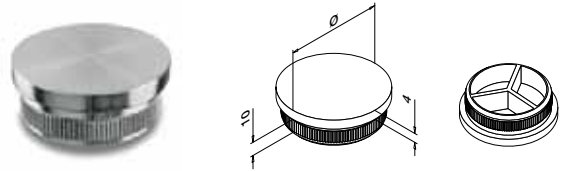

MOD 5732 - EASY HIT®

V2A	304	Gebürstet		
INDOOR*				
			Für Rohr Ø	
	135732-233-12		33,7 x 2,0	2
	135732-242-12		42,4 x 2,0	2
SELL OUT	135732-042-12		42,4 x 2,6	2
	135732-248-12		48,3 x 2,0	2
	135732-048-12		48,3 x 2,6	2
V2A	304	Black Line		
INDOOR				
NEW	135732-242-82		42,4 x 2,0	2
V4A	316	Gebürstet		
OUTDOOR				
	145732-233-12		33,7 x 2,0	2
	145732-242-12		42,4 x 2,0	2
SELL OUT	145732-042-12		42,4 x 2,6	2
	145732-248-12		48,3 x 2,0	2
	145732-048-12		48,3 x 2,6	2

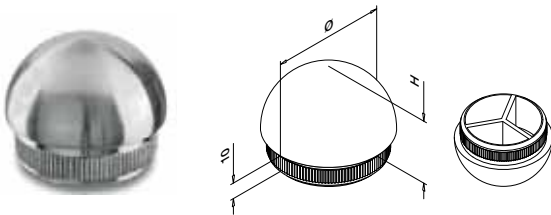

MOD 5730 - EASY HIT®

V2A	304	Gebürstet			
INDOOR*					
			Für Rohr Ø	H	
	135730-233-12		33,7 x 2,0	17	2
	135730-242-12		42,4 x 2,0	21	2
SELL OUT	135730-042-12		42,4 x 2,6	21	2
SELL OUT	135730-248-12		48,3 x 2,0	24	2
V4A	316	Gebürstet			
OUTDOOR					
	145730-242-12		42,4 x 2,0	21	2

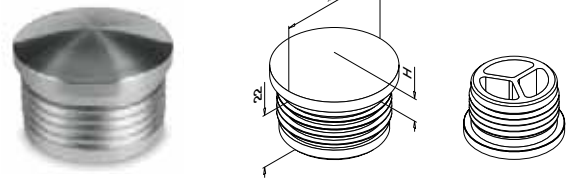

MOD 5729 - EASY HIT®

	Kunststoff	Edelstahleffekt			
INDOOR					
			Für Rohr Ø	H	
	155729-233		33,7 x 2,0	8	2
	155729-242		42,4 x 2,0	9	2
	155729-248		48,3 x 2,0	9	2



MOD 0729

V2A	304	Gebürstet			
INDOOR*					
			Für Rohr Ø	H	
SELL OUT	130729-242-10		42,4 x 2,0	9	2
V4A	316	Hochglanzpoliert			
OUTDOOR					
	140729-242-10		42,4 x 2,0	9	2



Q-INFO | MOD 5729 / 5730 / 5732

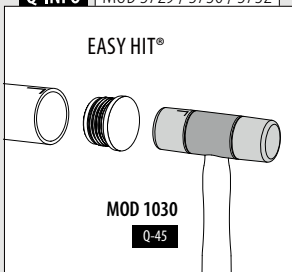

Q-INFO | MOD 0729

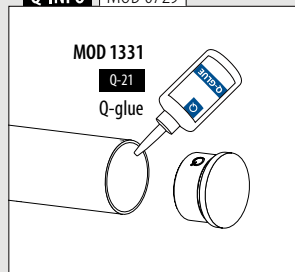

Endbögen

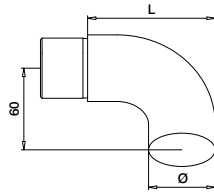

MOD 0739

V2A	304	Gebürstet		
INDOOR*		Für Rohr Ø	L	
	130739-233-12	33,7 x 2,0	77	2
	130739-242-12	42,4 x 2,0	81	2
SELL OUT	130739-042-12	42,4 x 2,6	81	2
	130739-248-12	48,3 x 2,0	84	2
	130739-048-12	48,3 x 2,6	84	2
V4A	316	Gebürstet		
OUTDOOR		Für Rohr Ø	L	
	140739-242-12	42,4 x 2,0	81	2
SELL OUT	140739-042-12	42,4 x 2,6	81	2
	140739-248-12	48,3 x 2,0	84	2
	140739-048-12	48,3 x 2,6	84	2



Für Treppenmontage

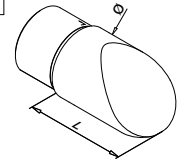

MOD 0738

V2A	304	Gebürstet		
INDOOR*		Für Rohr Ø	L	
	130738-242-12	42,4 x 2,0	60	2
	130738-248-12	48,3 x 2,0	65	2
V4A	316	Gebürstet		
OUTDOOR		Für Rohr Ø	L	
	140738-242-12	42,4 x 2,0	60	2



Internationaler Geschmacksmusterschutz

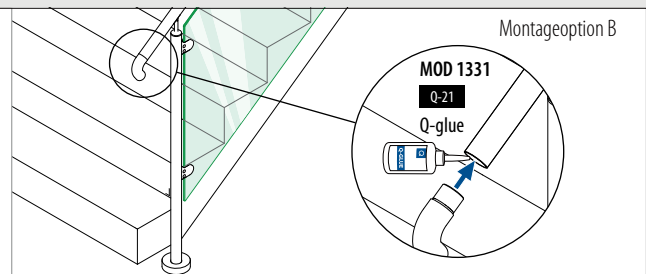
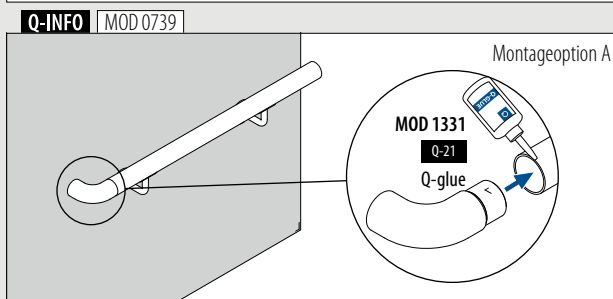
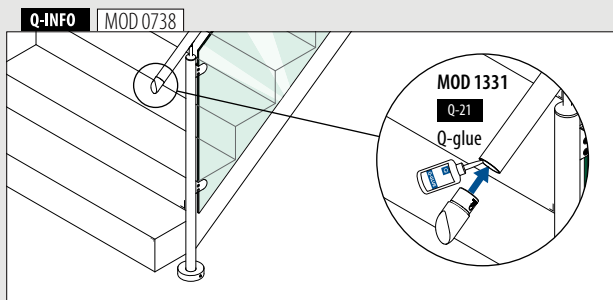

* Auch für Aussenanwendung geeignet bei entsprechenden Bedingungen.

Nur solange der Vorrat reicht.

Wandflansche

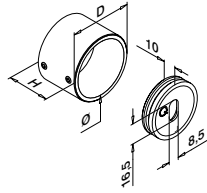

MOD 0504

V2A	304	Gebürstet						
INDOOR*			Ø	D	H			
130504-033-12	33,7	41	30	QS-55	470 / QS-21	472	2	
130504-042-12	42,4	50	35	QS-55	470 / QS-21	472	2	
130504-048-12	48,3	56	35	QS-55	470 / QS-21	472	2	

V4A	316	Gebürstet						
OUTDOOR			Ø	D	H			
140504-033-12	33,7	41	30	QS-55	470 / QS-22	472	2	
140504-042-12	42,4	50	35	QS-55	470 / QS-22	472	2	
140504-048-12	48,3	56	35	QS-55	470 / QS-22	472	2	

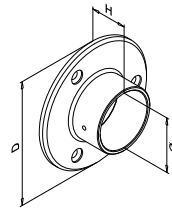

MOD 0505

V2A	304	Gebürstet						
INDOOR*			Für Rohr Ø	D	H			
130505-033-12	33,7	85	30	QS-7	471	2		
130505-042-12	42,4	95	30	QS-7	471	2		
130505-048-12	48,3	100	35	QS-7	471	2		
SELL OUT	130505-060-12	60,3	115	40	QS-7	471	2	

V4A	316	Gebürstet						
OUTDOOR			Für Rohr Ø	D	H			
NEW	140505-033-12	33,7	85	30	QS-50	471	2	
	140505-042-12	42,4	95	30	QS-50	471	2	
	140505-048-12	48,3	100	35	QS-50	471	2	

V4A	316	Hochglanzpoliert						
OUTDOOR			Für Rohr Ø	D	H			
	140505-042-10	42,4	95	30	QS-50	471	2	



Wandflansche

Justierbar



0 - 50°

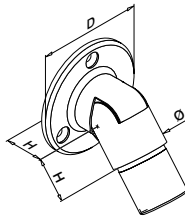

MOD 0506

V2A	304	Gebürstet						
INDOOR*			Für Rohr Ø	D	H			
SELL OUT	130506-033-12	33,7 x 2,0	70	26	QS-7	471	2	
	130506-042-12	42,4 x 2,0	75	30	QS-7	471	2	
SELL OUT	130506-048-12	48,3 x 2,0	80	33	QS-7	471	2	

V4A	316	Gebürstet						
OUTDOOR			Für Rohr Ø	D	H			
NEW	140506-033-12	33,7 x 2,0	70	26	QS-50	471	2	
NEW	140506-042-12	42,4 x 2,0	75	30	QS-50	471	2	



Internationaler Geschmacksmusterschutz

Q-INFO 304 316

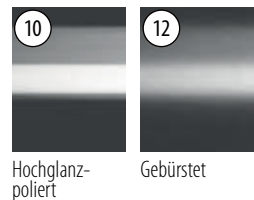

Hochglanzpoliert

Gebürstet

Q-INFO MOD 0504

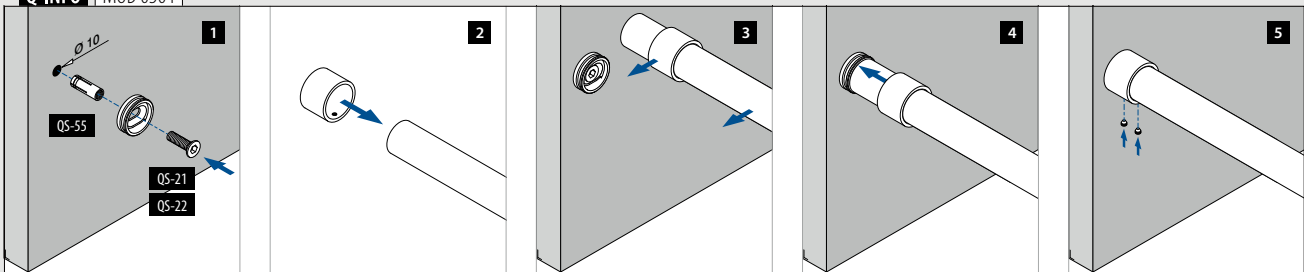



Finden Sie alle
Informationen zu
Barrier Line online:



[https://q-ne.ws/
BarrierLine23](https://q-ne.ws/BarrierLine23)



BARRIER LINE

Absperrbügel

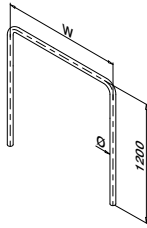

MOD 0090

V4A	316	Gebürstet			
OUTDOOR		W	Ø		
140090-248-09-12	900	48,3 x 2,0	1		
140090-248-12-12	1200	48,3 x 2,0	1		

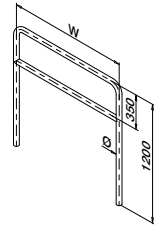

MOD 0091

V4A	316	Gebürstet			
OUTDOOR		W	Ø		
140091-248-09-12	900	48,3 x 2,0	1		
140091-248-12-12	1200	48,3 x 2,0	1		

Abdeckkappen

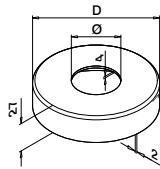

MOD 0511

V4A	316	Gebürstet			
OUTDOOR		Ø	D		
140511-048-12	48,3	120	2		

Q-INFO MOD 0090 / 0091

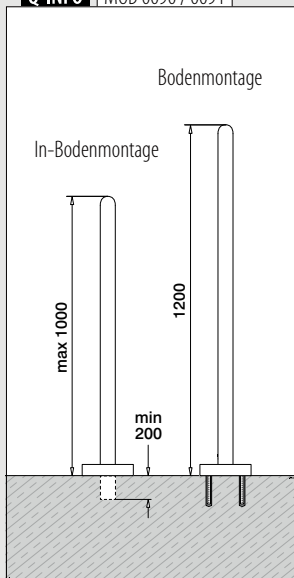

Q-INFO MOD 0090 / 0091



Q-INFO

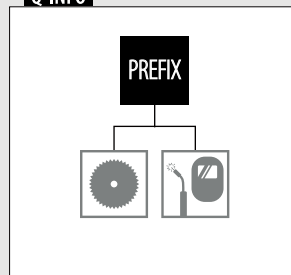

Q-INFO

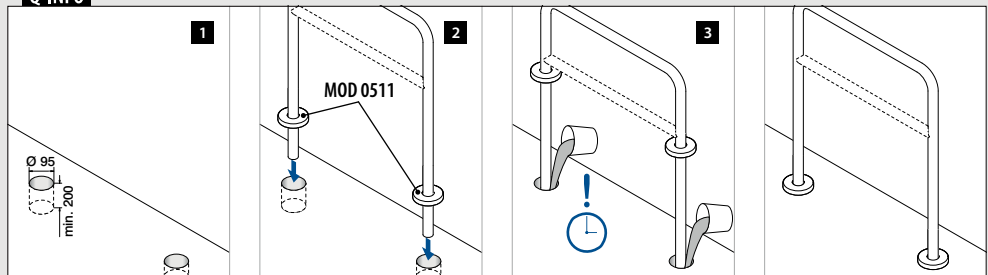



Finden Sie alle
Informationen zu polierten
Produkten online:

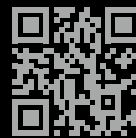

[https://q-ne.ws/
Polished23](https://q-ne.ws/Polished23)

The background image shows a balcony with a glass railing and stainless steel posts. A green lamp hangs from the ceiling. In the distance, a harbor with many boats is visible, along with a town and a church spire.

HOCHGLANZPOLIERT

Geländerpfosten

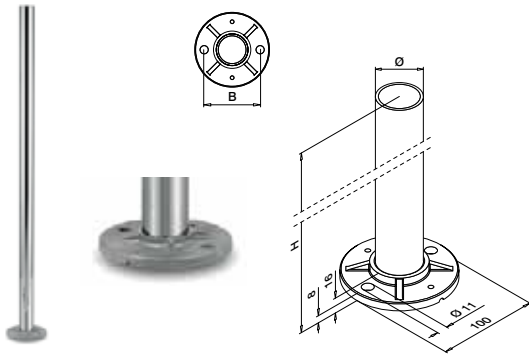

MOD 0921

V4A	316	Hochglanzpoliert				
	OUTDOOR		Ø	H	B	467
	140921-242-10		42,4 x 2,0	989	75	1



Abdeckkappen



MOD 0512

V4A	316	Hochglanzpoliert			
	OUTDOOR		Ø	D	
	140512-042-10		42,4	105	2



Geländerpfostenhalterungen

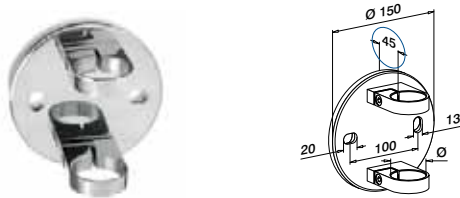

MOD 0551

V2A	304	Hochglanzpoliert			
	INDOOR*		Ø		
SELL OUT	130551-042-10		42,4	QS-33	464
V4A	316	Hochglanzpoliert			
	OUTDOOR		Ø		
	140551-042-10		42,4	QS-32	464



Geländerpfostenhalterungen

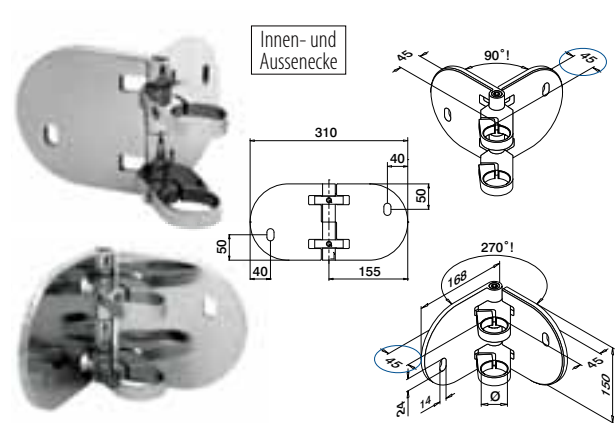

MOD 0555

V4A	316	Hochglanzpoliert			
	OUTDOOR		Ø		
	140555-042-10		42,4	QS-32	464



* Auch für Aussenanwendung geeignet bei entsprechenden Bedingungen.

SELL OUT Nur solange der Vorrat reicht.

Q-INFO | MOD 0551 / 0555

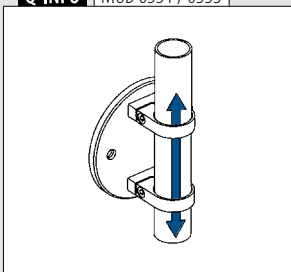

Q-INFO | MOD 0921

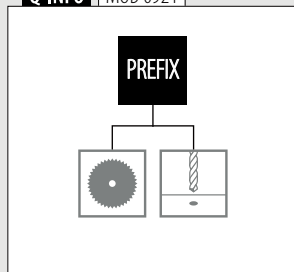

Q-INFO | MOD 0551 / 0552



Für rundes Rohr

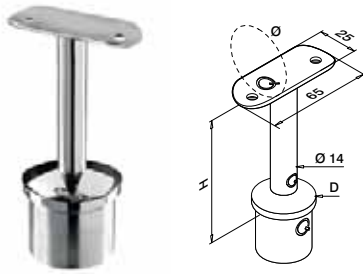

MOD 0710

V4A	316	Hochglanzpoliert					
OUTDOOR			D	Ø	H		
140710-042-00-10	42,4 x 2,0	42,4	79	QS-11	472	2	



Für rundes Rohr

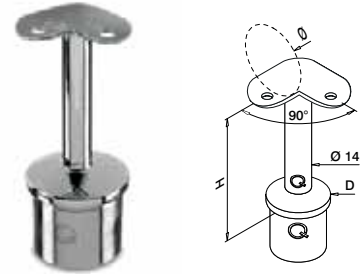

MOD 0710

V4A	316	Hochglanzpoliert					
OUTDOOR			D	Ø	H		
140710-042-90-10	42,4 x 2,0	42,4	79	QS-11	472	2	



Für rundes Rohr

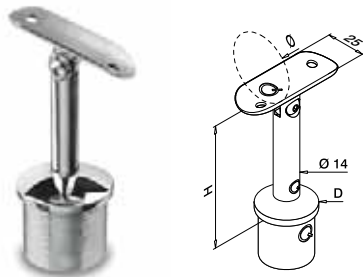

MOD 0718

V4A	316	Hochglanzpoliert					
OUTDOOR			D	Ø	H		
140718-042-10	42,4 x 2,0	42,4	79	QS-11	472	2	



Q-INFO | MOD 071x-042-00

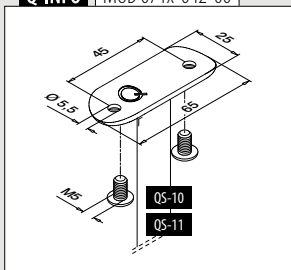

Q-INFO | MOD 0718

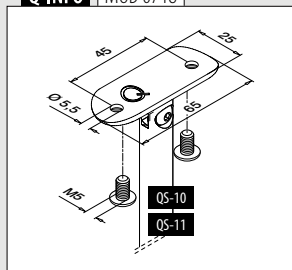

Q-INFO | MOD 071x-04x-90

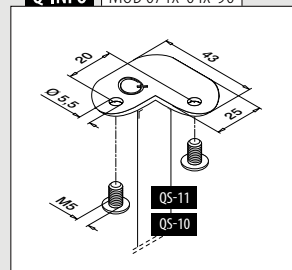

Q-INFO | MOD 071x-04x-90

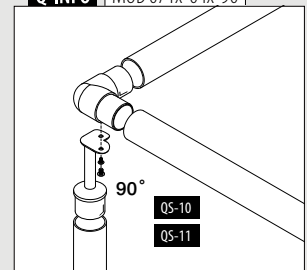

Für rundes Rohr

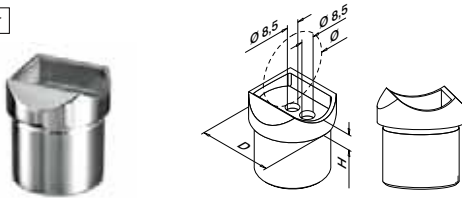

MOD 0770

V4A	316	Hochglanzpoliert				
	OUTDOOR	D	Ø	H		
140770-042-10		42,4 x 2,0	42,4	9	QS-27 472	2



Kombinierbar mit MOD 0303 Verbinders.

Für rundes Rohr

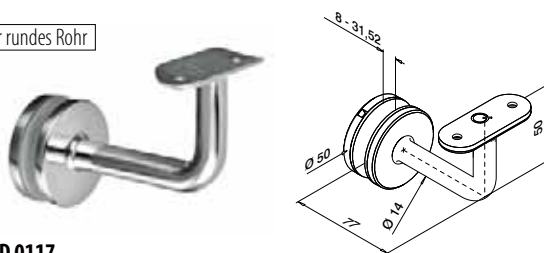

MOD 0117

V4A	316	Hochglanzpoliert				
	OUTDOOR	Ø				
140117-042-10		42,4			QS-11 472	2
140117-048-10		48,3			QS-11 472	2



Q-INFO MOD 0770

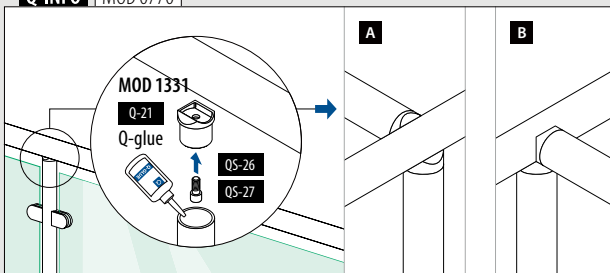

Q-INFO MOD 0117

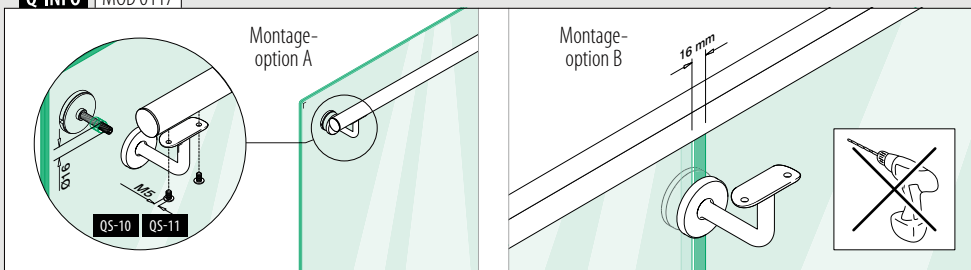

Q-INFO MOD 0117

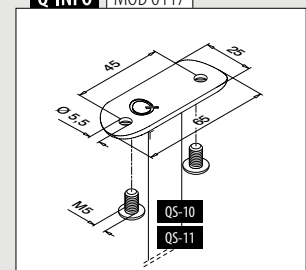

Für rundes Rohr

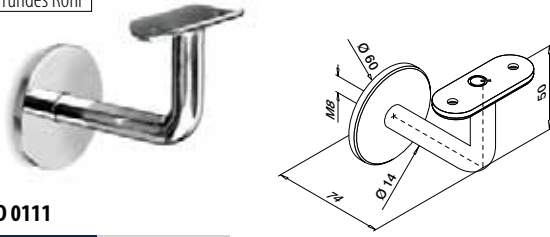

MOD 0111

V2A	304	Hochglanzpoliert		
	INDOOR*	Ø		
SELL OUT	130111-042-10	42,4	QS-10	472 2
V4A	316	Hochglanzpoliert		
	OUTDOOR			
	140111-042-10	42,4	QS-11	472 2



Für rundes Rohr

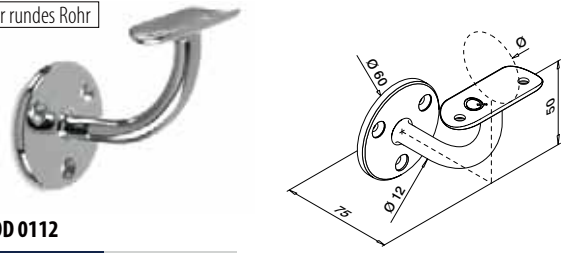

MOD 0112

V2A	304	Hochglanzpoliert		
	INDOOR*	Ø		
SELL OUT	130112-042-10	42,4	QS-7	471 / QS-10
			472 / QS-87	470 2
V4A	316	Hochglanzpoliert		
	OUTDOOR			
	140112-042-10	42,4	QS-50	471 / QS-11
			472 / QS-87	470 2



* Auch für Aussenanwendung geeignet bei entsprechenden Bedingungen.

SELL OUT Nur solange der Vorrat reicht.

Q-INFO | MOD 0111

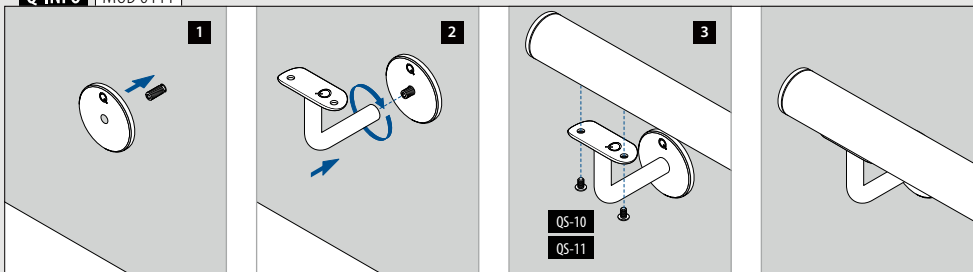

Q-INFO

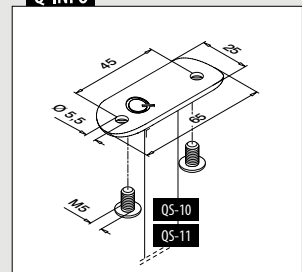

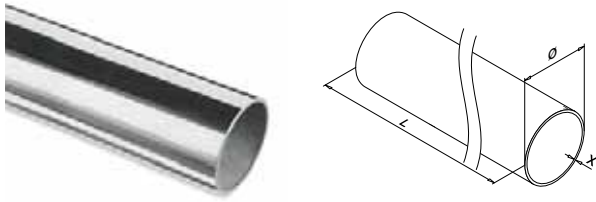

MOD 0900

V2A	304	Hochglanzpoliert		
	INDOOR*	Ø	X	
SELL OUT	130900-242-50-10	42,4	2,0	L = 5 m
V4A	316	Hochglanzpoliert		
	OUTDOOR			
	140900-242-50-10	42,4	2,0	L = 5 m

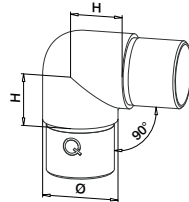
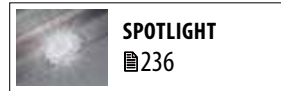

MOD 0303

V4A	316	Hochglanzpoliert		
	OUTDOOR	Für Rohr Ø	H	
	140303-242-10	42,4 x 2,0	30	2



Kombinierbar mit MOD 0710, 0810 und 4710 Handlaufstützen

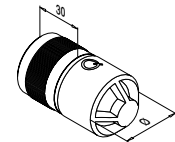

MOD 5792 - EASY HIT®

V2A	304	Roh		
	INDOOR*	Für Rohr Ø		
SELL OUT	135792-242	42,4 x 2,0	2	
V4A	316	Roh		
	OUTDOOR			
	145792-242	42,4 x 2,0	2	



Internationaler Geschmacksmusterschutz

Q-INFO | MOD 5792

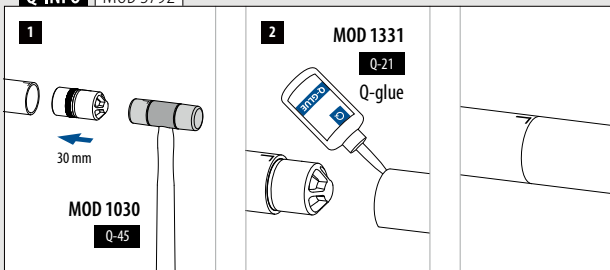

Q-INFO | MOD 0900

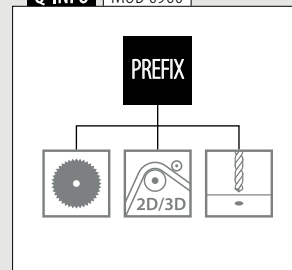



0-70°

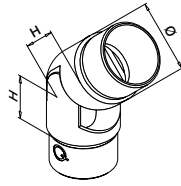

MOD 0312

V4A	316	Hochglanzpoliert			
	OUTDOOR	Für Rohr Ø	H		
	140312-242-10	42,4 x 2,0	27	2	



Internationaler Geschmacksmusterschutz

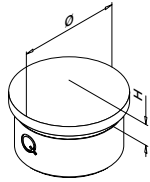

MOD 0729

V2A	304	Hochglanzpoliert			
	INDOOR*	Für Rohr Ø	H		
SELL OUT	130729-242-10	42,4 x 2,0	9	2	
V4A	316	Hochglanzpoliert			
	OUTDOOR	Für Rohr Ø	H		
	140729-242-10	42,4 x 2,0	9	2	

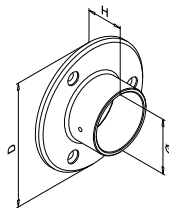

MOD 0505

V4A	316	Hochglanzpoliert					
	OUTDOOR	Für Ø	D	H			
	140505-042-10	42,4	95	30	QS-50 ■ 471	2	



* Auch für Aussenanwendung geeignet bei entsprechenden Bedingungen.

Querstabhalter

Für rundes Rohr

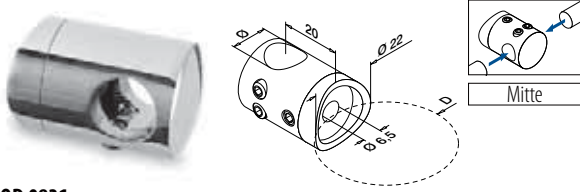

MOD 0831

V4A	316	Hochglanzpoliert			
	OUTDOOR	D	Ø		
140831-042-10	42,4	12	QS-16	472	4



Stäbe

Q-TUBE



MOD 1910

V4A	316	Hochglanzpoliert		
	OUTDOOR	Ø		
141910-012-50-10	12	L = 5 m		



Q-INFO MOD 1910

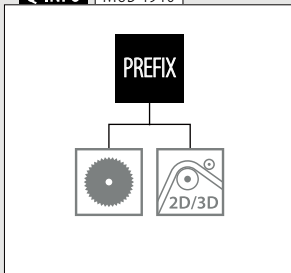

Q-INFO MOD 0831

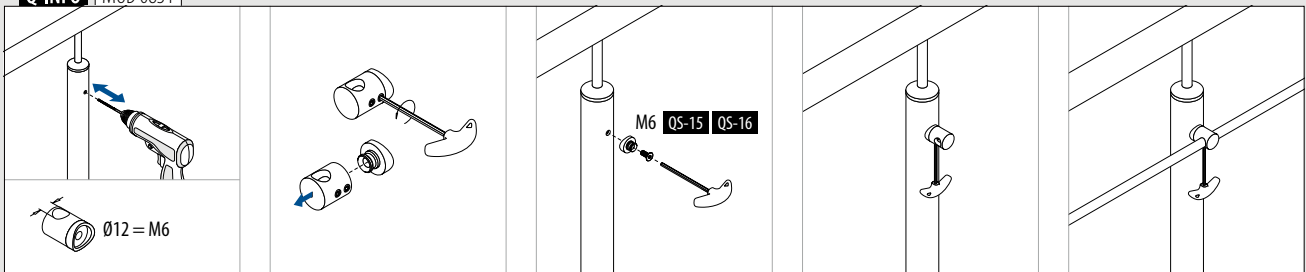

Blechadapter - MOD 2800

Für flaches Rohr

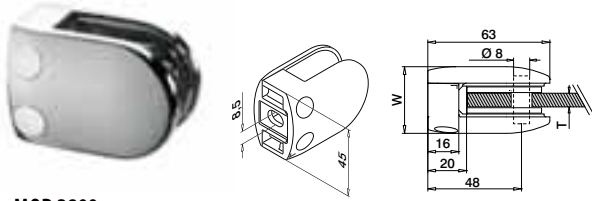

MOD 2800

V2A	304	Hochglanzpoliert			
INDOOR*			W	T	
SELL OUT	132800-000-10	34	Siehe MOD 5028	QS-26	474 4
V4A	316	Hochglanzpoliert			
OUTDOOR					
	142800-000-10	34	Siehe MOD 5028	QS-27	474 4



Internationaler Geschmacksmusterschutz

Für rundes Rohr

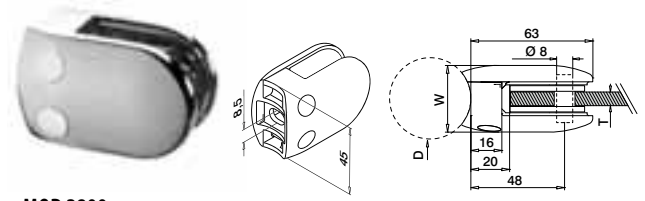

MOD 2800

V2A	304	Hochglanzpoliert			
INDOOR*			D	W	T
SELL OUT	132800-042-10	42,4	34	Siehe MOD 5028	QS-47 474 4
V4A	316	Hochglanzpoliert			
OUTDOOR					
	142800-042-10	42,4	34	Siehe MOD 5028	QS-45 474 4



Internationaler Geschmacksmusterschutz

Gummieinlagen für Blechadapter MOD 2800



2 Stück pro Blechadapter

MOD 5028

Zubehör		
	T	
205028-02	2	8
205028-03	3	8
205028-04	4	8



MOD 2800 Glasklemmen - hochglanzpoliert
433

Sicherungsstifte

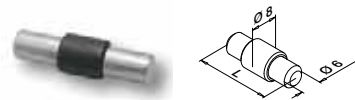

Optional verwendbar für MOD 2800

MOD 5015

Zubehör		
	L	
205015-22	22	4

Q-INFO

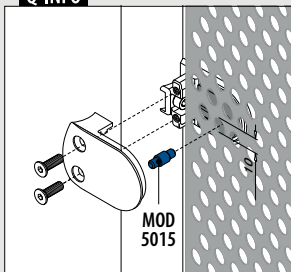

* Auch für Aussenanwendung geeignet bei entsprechenden Bedingungen.

Bitte bestellen Sie Sicherungsstifte und Befestigungsmaterial separat.

SELL OUT Nur solange der Vorrat reicht.

Blechadapter - MOD 4200

Für flaches Rohr

Inklusive Sicherungsplatte

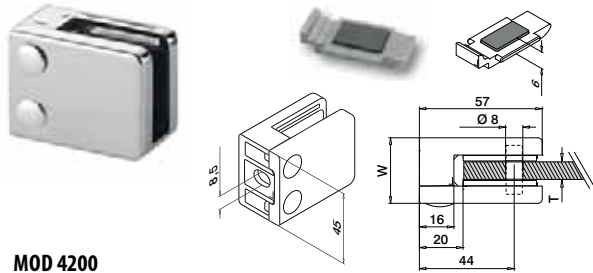

MOD 4200

V4A	316	Hochglanzpoliert				
	OUTDOOR	W	T			
144200-000-10	28	Siehe MOD 5042	QS-27	474	4	



Internationaler
Geschmacksmusterschutz

Für rundes Rohr

Inklusive Sicherungsplatte

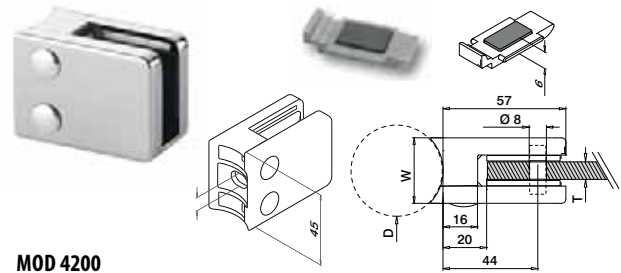

MOD 4200

V4A	316	Hochglanzpoliert				
	OUTDOOR	D	W	T		
144200-042-10	42,4	28	Siehe MOD 5042	QS-45	474	4
144200-048-10	48,3	28	Siehe MOD 5042	QS-45	474	4



Internationaler
Geschmacksmusterschutz

Gummieinlagen für Blechadapter MOD 4200



2 Stück pro
Blechadapter

MOD 5042

	Zubehör		
		T	
205042-02	2	8	
205042-03	3	8	
205042-04	4	8	

Sicherungsstifte

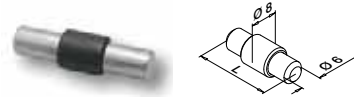

Optional verwendbar
für MOD 4200

MOD 5015

	Zubehör		
		L	
205015-22	22	4	



MOD 4200 Glasklemmen - hochglanzpoliert
434

Q-INFO

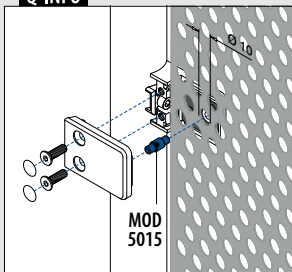



Finden Sie alle
Informationen zu
Schweissteilen online:

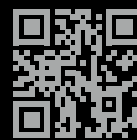

[https://q-ne.ws/
Welding23](https://q-ne.ws/Welding23)

A welder in a blue protective suit and mask is working on a metal piece. The welder is wearing heavy-duty gloves and using a welding torch. A bright blue and white light is visible at the point of contact between the torch and the metal. The background is dark, emphasizing the welder and the work.

SCHWEISSTEILE

Bodenflanche für Geländerpfosten

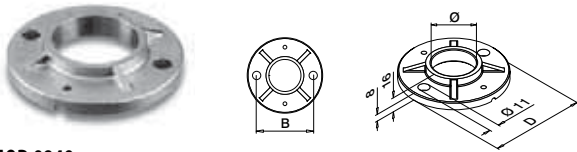

MOD 0940

V2A	304	Roh							
			INDOOR*	Ø	B	D			
	130940-042			42,4	75	100	QS-59	467	2
	130940-048			48,3	80	100	QS-59	467	2
V4A	316	Roh							
			OUTDOOR	Ø	B	D			
	140940-042			42,4	75	100	QS-58	467	2
	140940-048			48,3	80	100	QS-58	467	2

MOD 0941

V4A	316	Roh							
			OUTDOOR	Ø	B	D			
	140941-048			48,3	90	120	QS-58	467	2

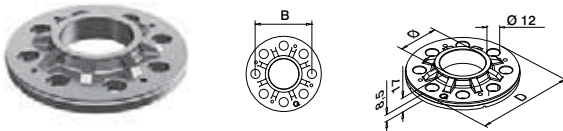

MOD 3504

V2A	304	Roh								
			INDOOR*	Ø	B	D				
	133504-042			42,4	80	105	QS-272	464 / QS-59	467	2
	133504-048			48,3	90	115	QS-272	464 / QS-59	467	2
V4A	316	Roh								
			OUTDOOR	Ø	B	D				
	143504-042			42,4	80	105	QS-273	464 / QS-58	467	2
	143504-048			48,3	90	115	QS-273	464 / QS-58	467	2

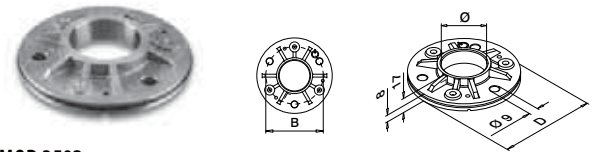

MOD 3502

V2A	304	Roh							
			INDOOR*	Ø	B	D			
	133502-042			42,4	80	105	QS-35	467	2
	133502-048			48,3	90	115	QS-35	467	2
V4A	316	Roh							
			OUTDOOR	Ø	B	D			
	143502-042			42,4	80	105	QS-34	467	2
	143502-048			48,3	90	115	QS-34	467	2

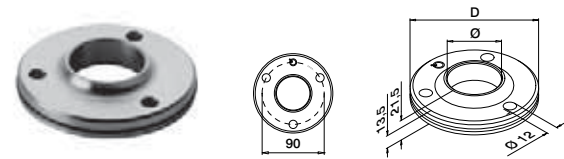

MOD 3505

V4A	316	Roh							
			OUTDOOR	Ø	B	D			
	143505-048			48,3	90	115	QS-273	464	2



* Auch für Aussenanwendung geeignet bei entsprechenden Bedingungen.

Q-INFO | MOD 3504

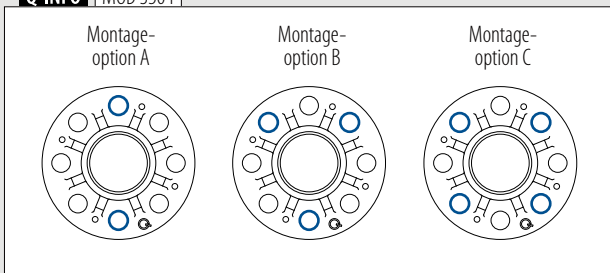

Q-INFO | MOD 0940

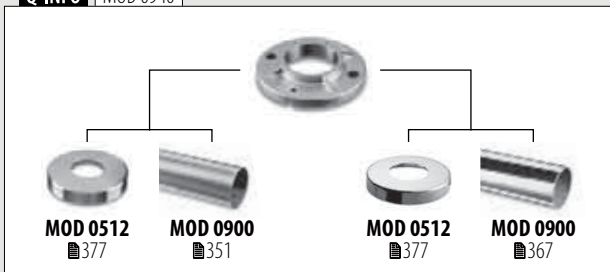

Q-INFO | MOD 0941



Q-INFO | MOD 3502 / 3505 / 3504

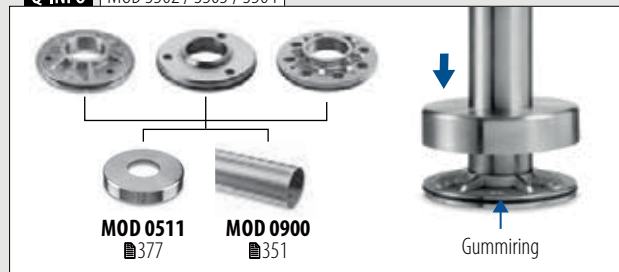

Bodenflanche für Geländerpfosten

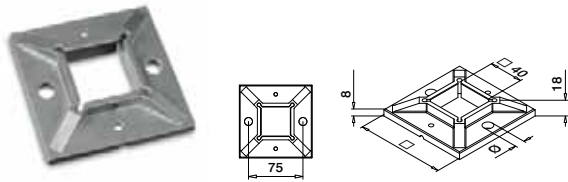

MOD 4940

V2A	304	Roh				
	INDOOR*	□	Ø	B		
134940-040	100	11	75	QS-59		467 2

V4A	316	Roh				
	OUTDOOR					
144940-040	100	11	75	QS-58		467 2

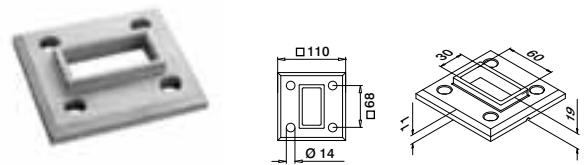

MOD 3503

V4A	316	Roh				
	OUTDOOR					
143503-063				QS-559		465 2

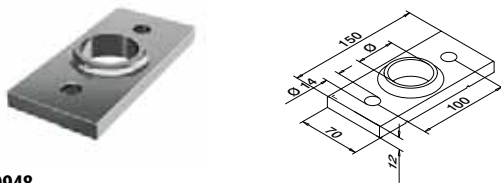

MOD 0948

V4A	316	Roh				
	OUTDOOR		Ø			
140948-042-00			42,4		QS-225	
140948-048-00			48,3		QS-225	

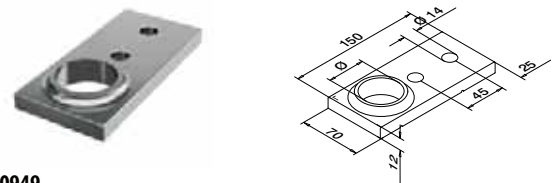

MOD 0949

V4A	316	Roh				
	OUTDOOR		Ø			
140949-042-00			42,4		QS-225	
140949-048-00			48,3		QS-225	



Abdeckkappen für MOD 0948

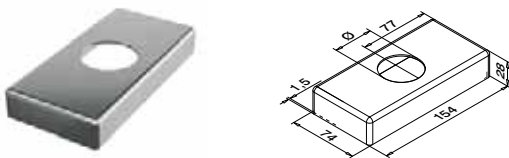

MOD 0514

V4A	316	Gebürstet				
	OUTDOOR		Ø			
140514-042-12			42,4			2
140514-048-12			48,3			2



Abdeckkappen für MOD 0949

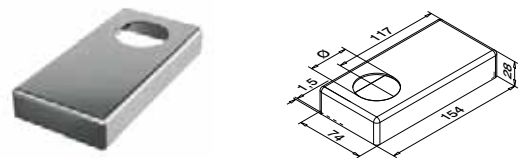

MOD 0515

V4A	316	Gebürstet				
	OUTDOOR		Ø			
140515-042-12			42,4			2
140515-048-12			48,3			2



Q-INFO | MOD 4940

MOD 4511
■377MOD 4900
■300

Q-INFO | MOD 3503

MOD 4513
■377MOD 4900-063
■305

Q-INFO | MOD 0948



MOD 0514

MOD 0900
■351

Q-INFO | MOD 0949



MOD 0515

MOD 0900
■351

Handlaufstützen

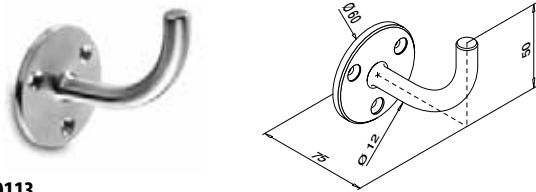

MOD 0113

V2A	304	Gebürstet		
INDOOR*				
130113	QS-7	471 / QS-87	470	2
V4A	316	Gebürstet		
OUTDOOR				
140113	QS-50	471 / QS-87	470	2

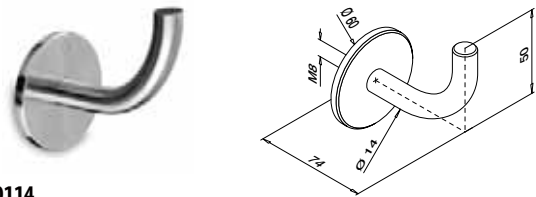

MOD 0114

V2A	304	Gebürstet		
INDOOR*				
SELL OUT 130114	QS-1	471		2
V4A	316	Gebürstet		
OUTDOOR				
SELL OUT 140114	QS-2	471		2

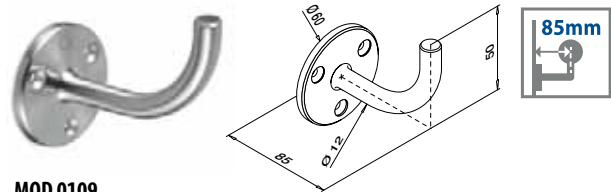

MOD 0109

V2A	304	Gebürstet		
INDOOR*				
130109	QS-7	471 / QS-87	470	2

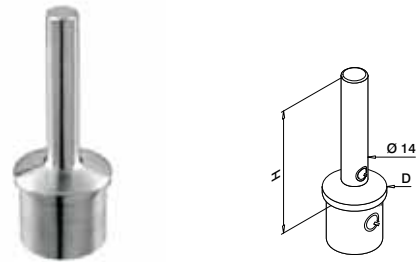

MOD 0695

V2A	304	Gebürstet		
INDOOR*				
		D	H	
130695		42,4 x 2,0	79	2
V4A	316	Gebürstet		
OUTDOOR				
140695		42,4 x 2,0	79	2

MOD 0696

V4A	316	Gebürstet		
OUTDOOR				
		D	H	
140696		48,3 x 2,0	80	2



* Auch für Aussenanwendung geeignet bei entsprechenden Bedingungen.

SELL OUT Nur solange der Vorrat reicht.

Flansche für Handlaufstützen

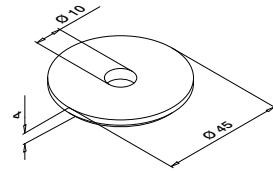

MOD 1937

V2A	304	Gebürstet	
INDOOR*			
131937			4

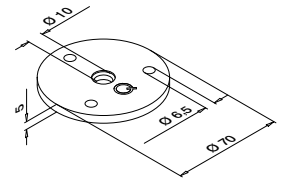

MOD 1936

V2A	304	Gebürstet	
INDOOR*			
131936		QS-56 471	4

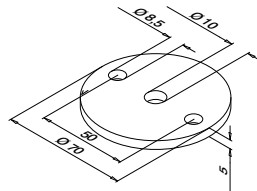

MOD 1939

V2A	304	Gebürstet	
INDOOR*			
131939		QS-3 471	8



MOD 1810
379



MOD 1801
379



MOD 1802
379

Schweissteile für Handlaufstützen

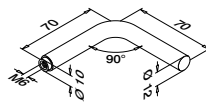

MOD 0813

V2A	304	Gebürstet	
INDOOR*			
130813		QS-14 472	2

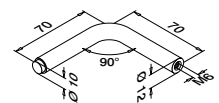

MOD 0814

V2A	304	Gebürstet	
INDOOR*			
130814-670			2

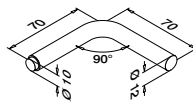

MOD 0815

V2A	304	Gebürstet	
INDOOR*			
130815			2

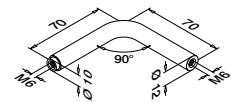

MOD 0816

V2A	304	Gebürstet	
INDOOR*			
130816		QS-14 472	2



Q-INFO MOD 0813

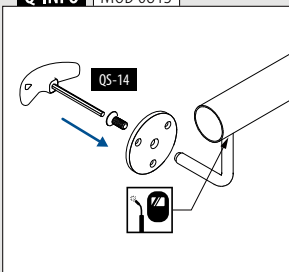

Q-INFO MOD 0814

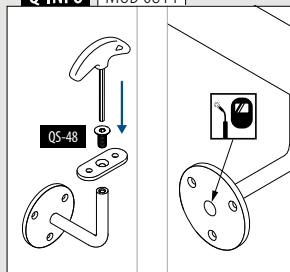

Q-INFO MOD 0815

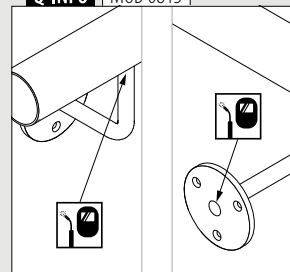

Q-INFO MOD 0816

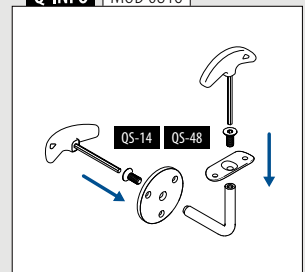

Abdeckkappen

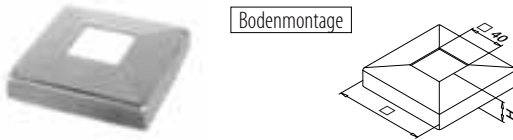

MOD 4511

V2A	304	Gebürstet		
	INDOOR*		H	
	134511-040-12	108	25	2
V4A	316	Gebürstet		
	OUTDOOR			
	144511-040-12	108	25	2



MOD 4513

V4A	316	Gebürstet		
	OUTDOOR			
	144513-063-12			2



MOD 0519

V4A	316	Gebürstet		
	OUTDOOR			
	140519			2
	Zinkdruckguss	Edelstahleffekt		
	INDOOR			
SELL OUT	100519			2



MOD 1514

V2A	304	Gebürstet		
	INDOOR*	Ø		
	131514-012	12,0		2
	131514-014	14,0		2



MOD 0512

V2A	304	Gebürstet		
	INDOOR*	Ø	D	
	130512-033-12	33,7	105	2
	130512-042-12	42,4	105	2
	130512-048-12	48,3	105	2



MOD 1515

V2A	304	Gebürstet		
	INDOOR*	Ø		
	131515-012	12,0		2

V4A	316	Gebürstet		
	OUTDOOR			
	140512-033-12	33,7	105	2
	140512-042-12	42,4	105	2
	140512-048-12	48,3	105	2

V4A	316	Hochglanzpoliert		
	OUTDOOR			
	140512-042-10	42,4	105	2
	140512-048-10	48,3	105	2

V2A	304	Gebürstet		
	INDOOR*	Ø	D	
	130513-042-12	42,4	125	2
	130513-048-12	48,3	125	2
SELL OUT	130513-060-12	60,3	125	2

V4A	316	Gebürstet		
	OUTDOOR			
	140513-042-12	42,4	125	2
	140513-048-12	48,3	125	2

* Auch für Aussenanwendung geeignet bei entsprechenden Bedingungen.

SELL OUT Nur solange der Vorrat reicht.

Q-INFO MOD 0519

Für MOD 0109, 0113 und 0114

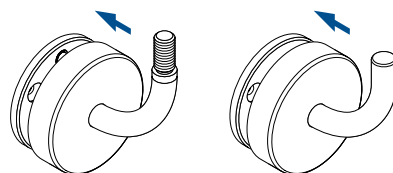

MOD 0519

MOD 0519



Handlauf-Anschlussplatten

Für flaches Rohr



MOD 1810

V2A	304	Gebürstet		
INDOOR*				
131810-000-12	QS-48	472 / QS-10	472	8
V4A	316	Gebürstet		
OUTDOOR				
141810-000-12	QS-89	472 / QS-11	472	8



Für rundes Rohr



MOD 1810

V2A	304	Gebürstet		
INDOOR*				
131810-033-12	33,7	QS-48	472 / QS-10	472
131810-042-12	42,4	QS-48	472 / QS-10	472
131810-048-12	48,3	QS-48	472 / QS-10	472
V4A	316	Gebürstet		
OUTDOOR				
141810-042-12	42,4	QS-89	472 / QS-11	472
141810-048-12	48,3	QS-89	472 / QS-11	472



Für flaches Rohr

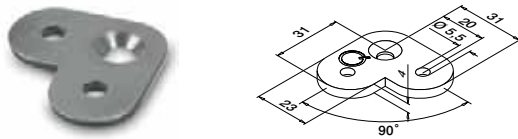

MOD 1802

V2A	304	Gebürstet		
INDOOR*				
131802-000	QS-48	472 / QS-10	472	8



Für rundes Rohr

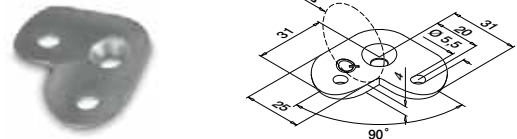

MOD 1802

V2A	304	Gebürstet		
INDOOR*				
131802-042	42,4	QS-48	472 / QS-10	472
131802-048	48,3	QS-48	472 / QS-10	472



Für flaches Rohr

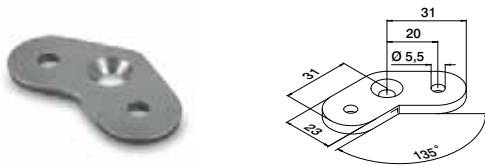

MOD 1801

V2A	304	Gebürstet		
INDOOR*				
131801-000	QS-48	472 / QS-10	472	8
SELL OUT				



Für rundes Rohr

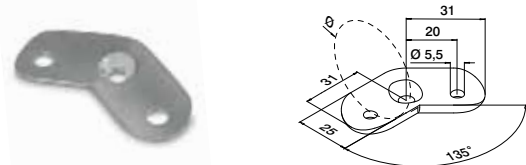

MOD 1801

V2A	304	Gebürstet		
INDOOR*				
131801-042	42,4	QS-48	472 / QS-10	472
131801-048	48,3	QS-48	472 / QS-10	472
SELL OUT				



MOD 0811 335	MOD 0812 335	MOD 5735, 5736 336
-----------------	-----------------	-----------------------

MOD 1936 376	MOD 1937 376	MOD 1939 376
-----------------	-----------------	-----------------

MOD 4811 296	MOD 4733 296
-----------------	-----------------

Für rundes Rohr

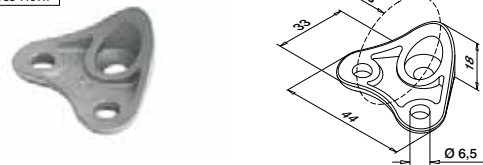

MOD 1820

V4A	316	Gebürstet		
OUTDOOR				
141820-042-12	42,4	QS-89	472 / QS-11	472

Kombinierbar mit MOD 0305 Verbinder.
Internationaler Geschmacksmusterschutz

* Auch für Aussenanwendung geeignet bei entsprechenden Bedingungen.

SELL OUT Nur solange der Vorrat reicht.



d line
HANDRAIL SYSTEM

Dänisches Design von *Knud Holscher.*

“Die Anmutung eines ausdrucksstarken und minimalistischen Edelstahl-Designs wird durch das d line Geländersystem formvollendet zum Ausdruck gebracht. Diese Produktlinie überzeugt durch ihre extrem ansprechende Optik und ihre ausgereifte Funktionalität. Sie ist einfach zu montieren, flexibel zu verändern und leicht instand zu halten. d line fügt sich in die anspruchsvollsten Architekturprojekte ein und unterstreicht deren Ästhetik.”

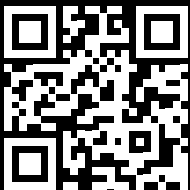

Entdecken Sie den d line Katalog auf
<https://q-ne.ws/DLine23>



reddot



Q-railing



BENDYWOOD

NATURAIL

Finden Sie alle Informationen zu Holz online:

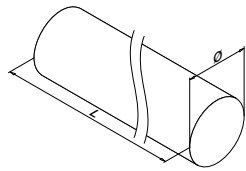

<https://q-ne.ws/Wood23>

**MOD 0990****Buche** Unbehandelt**INDOOR**

Ø



170990-042-36-39

42,0

L = 3,6 m

170990-042-66-39

42,0

L = 6,6 m

PREFIX



Bitte beachten Sie die dem Produkt beiliegende Montageanleitung. Holz ist ein Naturprodukt. Farbabweichungen sind möglich.

Q-INFO

PREFIX

**Q-INFO**Ø 42 R_{min} : 840 mm

Verarbeitung innerhalb von 4 Monaten nach Lieferung möglich, wenn Biegeholz in Verpackung belassen wird!

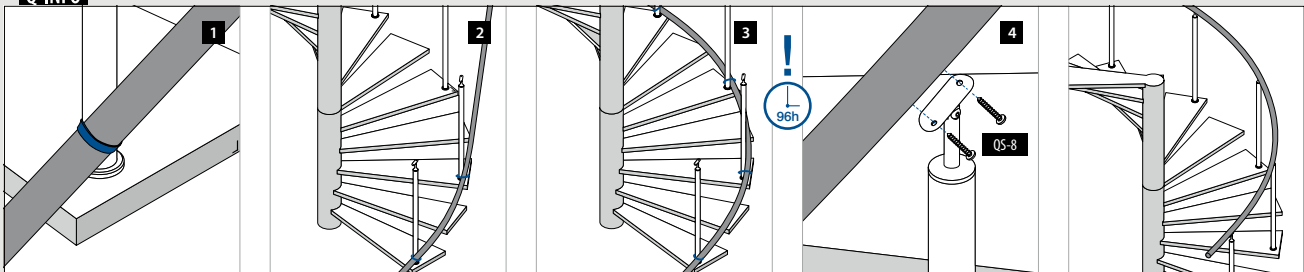
Q-INFO

Handläufe

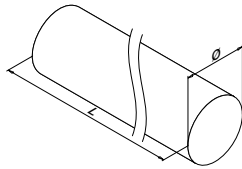

MOD 0950

Buche	Unbehandelt		
INDOOR	Ø		
170950-042-25-39	42,0		L = 2,5 m

PREFIX

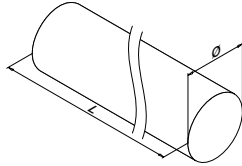

MOD 0950

Buche	Natur lackiert		
INDOOR	Ø		
170950-042-25-40	42,0		L = 2,5 m

PREFIX

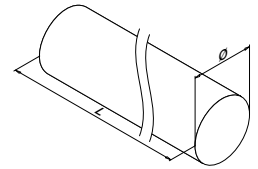

MOD 0950

Eiche	Natur lackiert		
INDOOR	Ø		
170950-042-25-43	42,0		L = 2,5 m

PREFIX

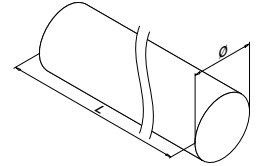

MOD 0950

Kambala	Unbehandelt		
OUTDOOR	Ø		
170950-042-25-47	42,0		L = 2,5 m

PREFIX

Zubehör

Dübel

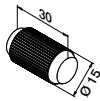

MOD 0203

Holz			
INDOOR	QS		
200203	QS-512		50

Handläufe

Verbinder

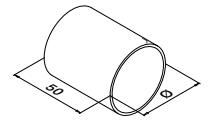

MOD 0793

V2A	304	Gebürstet		
	INDOOR*	Ø		
170793-042	42,0	QS-7	471	2
V4A	316	Gebürstet		
	OUTDOOR			
180793-042	42,0	QS-50	471	2



Q-INFO MOD 0950



Q-INFO

Holz ist ein Naturprodukt.
Farbabweichungen sind möglich.

Q-INFO MOD 0950

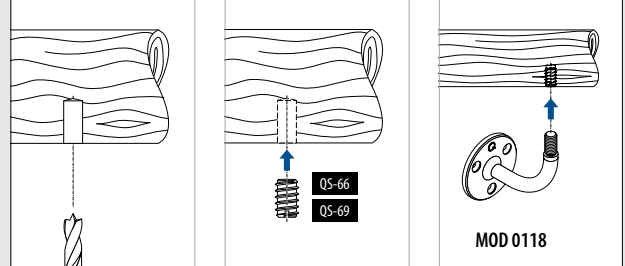

Q-INFO MOD 0950 / 0203

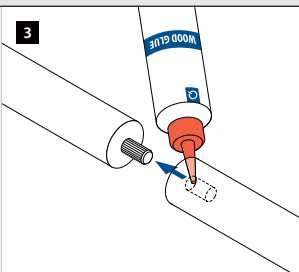
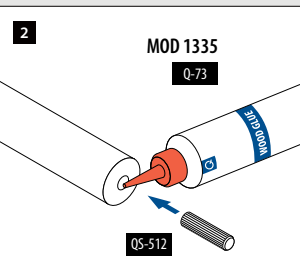
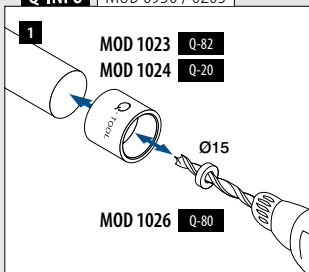

Q-INFO MOD 0950

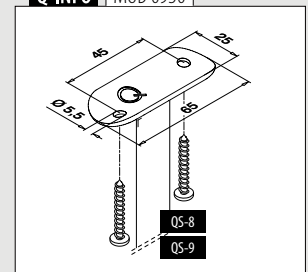



MOD 0313

V4A	316	Gebürstet			
	OUTDOOR	Ø			
180313-042	42,0	QS-50	471	2	

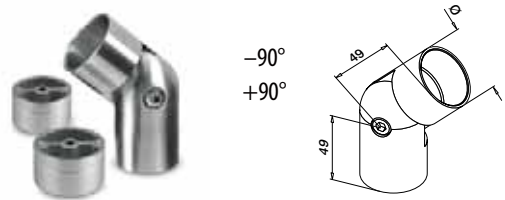

MOD 0308

V2A	304	Gebürstet			
	INDOOR*	Ø			
170308-042	42,0	QS-7	471	2	



Adapter



MOD 0301

V2A	304	Gebürstet			
	INDOOR*	Ø			
170301-042	42,0	QS-7	471	2	
V4A	316	Gebürstet			
	OUTDOOR	Ø			
180301-042	42,0	QS-50	471	2	



Nicht kombinierbar mit MOD 0710, 0810 und 4710 Handlaufstützen.

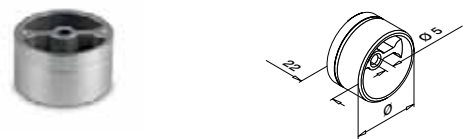

MOD 0792

V2A	304	Roh			
	INDOOR*	Ø			
170792-042	42,0	QS-7	471	2	
V4A	316	Roh			
	OUTDOOR	Ø			
180792-042	42,0	QS-50	471	2	



Endkappen



MOD 0732

V2A	304	Gebürstet			
	INDOOR*	Ø			
170732-042	42,0	QS-7	471	2	
V4A	316	Gebürstet			
	OUTDOOR	Ø			
180732-042	42,0	QS-50	471	2	



MOD 0739

V2A	304	Gebürstet			
	INDOOR*	Ø			
170739-042	42,0	QS-7	471	2	



Q-INFO

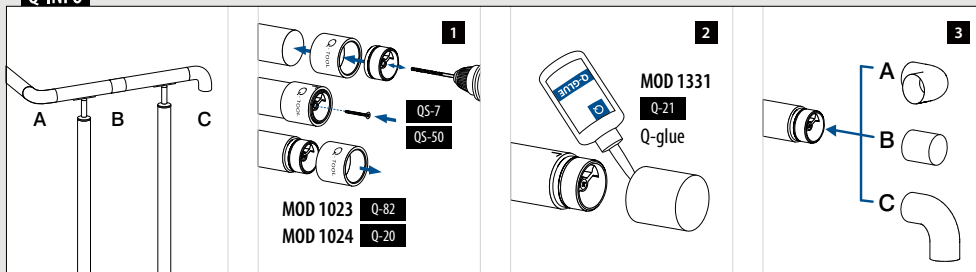

* Auch für Aussenanwendung geeignet bei entsprechenden Bedingungen.



Finden Sie alle
Informationen zu
Glasfüllungen online:



g-ne.ws/Infills23



Q-GLASS

FÜLLUNGEN - GLAS

Bestellen Sie die Glaselemente zeitgleich mit allen
anderen Produkten für Ihr Pfostengeländer

Massgefertigtes Glas

- 6 mm monolithisches Glas bis hin zu 21,52 mm Verbundsicherheitsglas
- Optional mit matter, farbiger oder SentryGlas®-Folie
- Abgerundete Ecken und polierte Kanten auf Anfrage
- Optional mit vorgebohrten Löchern
- Gebogenes Glas

Glas in der Standardausführung

- Sofort ab Lager verfügbar
- Verbundsicherheitsglas
- 8,76 mm stark (6 verschiedene Glasbreiten)
- Geschliffene, gesäumte und polierte Kanten
- Abgerundete Ecken

■ CE-Kennzeichnung ■ Hohe Qualität ■ Schnelle Lieferung ■ All-inclusive-Preise ■ Einfache Bestellung

Q-GLASS (Verbund-)Sicherheitsglas

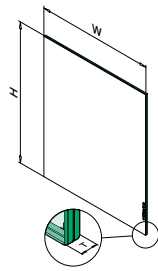

MOD 5009

(Verbund-)Sicherheitsglas ESG/VSG

OUTDOOR	H	W	T
195009-070-08	800	700	8,76
195009-080-08	800	800	8,76
195009-090-08	800	900	8,76
195009-095-08	800	950	8,76
195009-100-08	800	1000	8,76
195009-150-08	800	1500	8,76



Q-glass ist direkt ab Lager lieferbar.

Achtung: Q-glass entspricht nicht der für die Schweiz zugelassenen Glasqualität. Zur Auswahl des korrekten Glasaufbaus konsultieren Sie bitte das jeweilige Prüfzertifikat.

Q-INFO

Berechnung

$$H (m) \times W (m) \times 2,5 \times 8 = \text{kg}$$

Beispiel



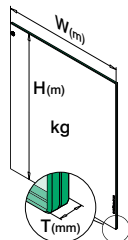

H	W	Tg
0,8 m	1,0 m	8 mm
0,8 x 1,0 x 2,5 x 8 = 16,00 kg		

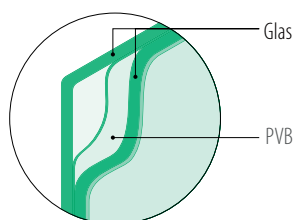
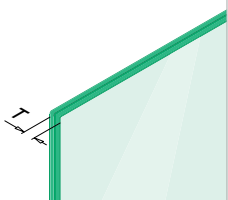

Q-INFO

(Verbund-)Sicherheitsglas



-  Geschliffene Kanten
-  Abgerundete Ecken
-  Gesäumte Kanten
-  Polierte Kanten

Halter

Für flaches Rohr

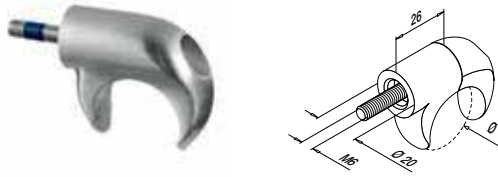

MOD 0860

V2A	304	Gebürstet		
INDOOR*			Ø	
130860-000		30		2
V4A	316	Gebürstet		
OUTDOOR				
140860-000		30		2



Internationaler Geschmacksmusterschutz

Für rundes Rohr

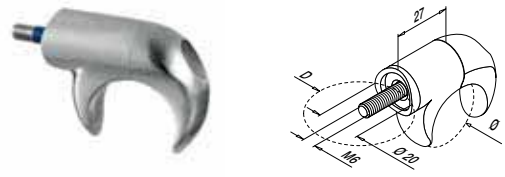

MOD 0860

V2A	304	Gebürstet			
INDOOR*			D	Ø	
130860-042		42,4		30	2
V4A	316	Gebürstet			
OUTDOOR					
140860-042		42,4		30	2
SELL OUT	140860-048		48,3	30	2



Internationaler Geschmacksmusterschutz

Glasrahmenrohr

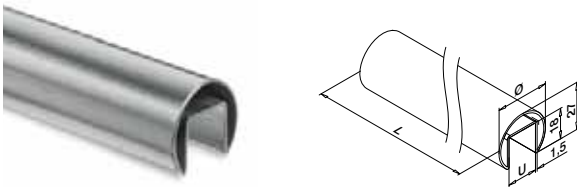

MOD 6930

V2A	304	Gebürstet			
INDOOR*			Ø	U	
SELL OUT	136930-25-12		30	14	L = 2,5 m
	136930-50-12		30	14	L = 5 m
V4A	316	Gebürstet			
OUTDOOR					
SELL OUT	146930-25-12		30	14	L = 2,5 m
	146930-50-12		30	14	L = 5 m

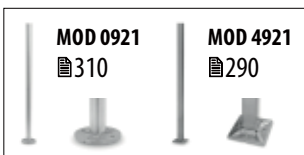

Glass Wing® Gummiprofile

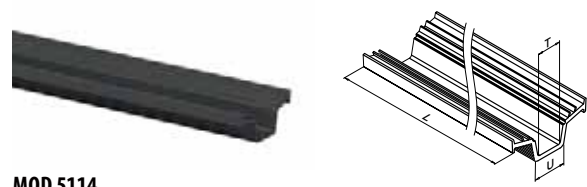

MOD 5114

Zubehör				
Für monolithisches Glas		U	T	
205114-050-08		14	8	L = 5 m
205114-050-10		14	10	L = 5 m
Für laminiertes Glas				
205114-050-08		14	8,76 - 9,52	L = 5 m
205114-050-10		14	10,76	L = 5 m

Internationaler Geschmacksmusterschutz

FÜLLUNGEN - GLASRAHMENROHR

* Auch für Aussenanwendung geeignet bei entsprechenden Bedingungen.

SELL OUT Nur solange der Vorrat reicht.

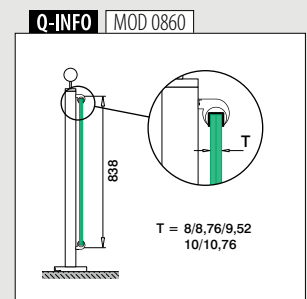
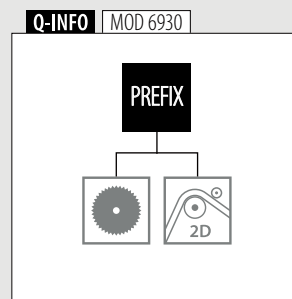
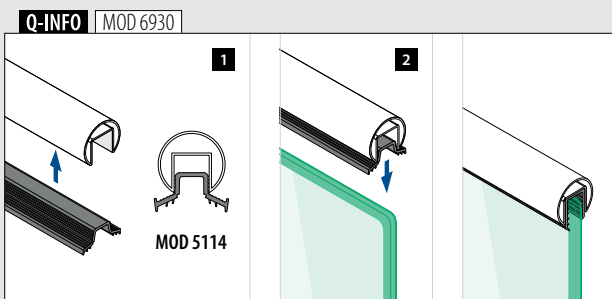



GLASRAHMENROHR

Q-railing

Verbinder

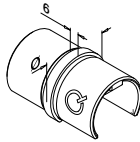

MOD 6793

V2A	304	Gebürstet		
	INDOOR*		Für Rohr Ø	
	136793-030-12		30 x 1,5	2
V4A	316	Gebürstet		
	OUTDOOR			
	146793-030-12		30 x 1,5	2

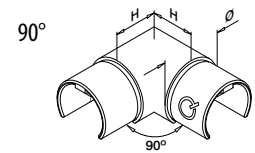

MOD 6333

V2A	304	Gebürstet			
	INDOOR*		Für Rohr Ø	H	
	136333-12		30 x 1,5	25	2
V4A	316	Gebürstet			
	OUTDOOR				
	146333-12		30 x 1,5	25	2



Handläufe

Verbinder

Justierbar



Abwärts
25-55°

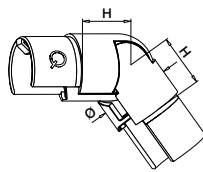

MOD 6332

V4A	316	Gebürstet			
	OUTDOOR		Für Rohr Ø	H	
	146332-02-12		30 x 1,5	25	2



Aufwärts
25-55°

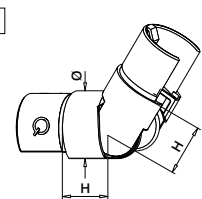

MOD 6332

V4A	316	Gebürstet			
	OUTDOOR		Für Rohr Ø	H	
	146332-01-12		30 x 1,5	25	2



Handläufe

Endkappen

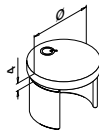

MOD 6733

V2A	304	Gebürstet		
	INDOOR*		Für Rohr Ø	
	136733-030-12		30 x 1,5	2
V4A	316	Gebürstet		
	OUTDOOR			
	146733-030-12		30 x 1,5	2



* Auch für Aussenanwendung geeignet bei entsprechenden Bedingungen.

Finden Sie alle
Informationen zu Stab- und
Rohrfüllungen online:

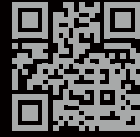

q-ne.ws/Infills23

FÜLLUNGEN - STAB UND ROHR

Füllungen

Stäbe

Q-TUBE

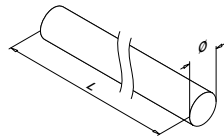

MOD 1910

V2A	304	Gebürstet		
INDOOR*		Ø		
131910-012-25-12	12		L = 2,5 m	
131910-012-50-12	12		L = 5 m	
V4A	316	Gebürstet		
OUTDOOR				
141910-012-25-12	12		L = 2,5 m	
141910-012-50-12	12		L = 5 m	
V4A	316	Hochglanzpoliert		
OUTDOOR				
141910-012-50-10	12		L = 5 m	



Füllungen

Rohre

Q-TUBE

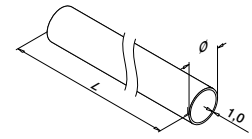

MOD 1900

V2A	304	Gebürstet		
INDOOR*		Ø		
131900-112-25-12	12		L = 2,5 m	
131900-112-50-12	12		L = 5 m	
V2A	304	Gebürstet		
INDOOR*				
131900-016-50-12	16		L = 5 m	
V4A	316	Gebürstet		
OUTDOOR				
141900-016-50-12	16		L = 5 m	



Füllungen

Verbinder

Justierbar



Für Stab
-90°
+90°

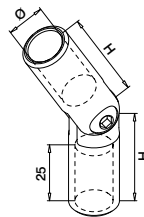

MOD 1312

V2A	304	Gebürstet		
INDOOR*		Ø	H	
131312-012-12	12		36	6
V4A	316	Gebürstet		
OUTDOOR				
141312-012-12	12		36	6



-90°
+90°

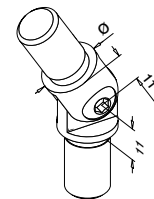

MOD 1302

V2A	304	Gebürstet		
INDOOR*		Für Rohr Ø		
131302-016-12	16 x 1,0		6	
V4A	316	Gebürstet		
OUTDOOR				
141302-016-12	16 x 1,0		6	



Füllungen

Verbinder

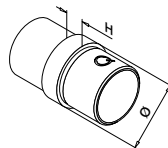

MOD 1790

V2A	304	Gebürstet		
INDOOR*		Für Rohr Ø	H	
131790-112-12	12 x 1,0		5	4
131790-016-12	16 x 1,0		6	4
V4A	316	Gebürstet		
OUTDOOR				
141790-016-12	16 x 1,0		6	4



Q-INFO | MOD 1910 / 1900

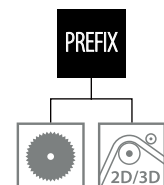

Endkappen



MOD 1729

V2A	304	Gebürstet			
	INDOOR*		Für Rohr Ø	H	
	131729-016-12		16,0 x 1,0	4	2
V4A	316	Gebürstet			
	OUTDOOR				
	141729-016-12		16,0 x 1,0	4	2

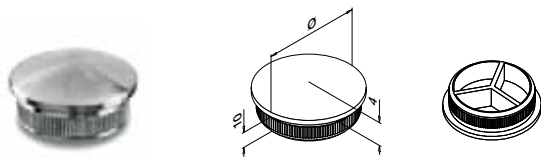

MOD 1759 - EASY HIT®

V2A	304	Gebürstet			
	INDOOR*		Für Rohr Ø		
	131759-112-12		12 x 1,0		4
V4A	316	Gebürstet			
	OUTDOOR				
NEW	141759-112-12		12 x 1,0		4

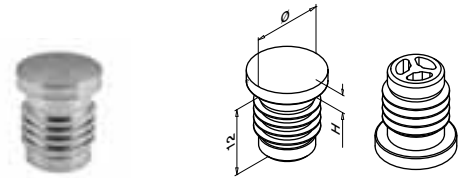

MOD 1759 - EASY HIT®

	Kunststoff	Edelstahleffekt			
	INDOOR		Für Rohr Ø	H	
	151759-112		12 x 1,0	3	4
	151759-016		16 x 1,0	4	4



MOD 0735

V2A	304	Gebürstet			
	INDOOR*		Ø		
	130735-012-12		12	QS-5 471	4
V4A	316	Gebürstet			
	OUTDOOR				
	140735-012-12		12	QS-6 471	4



Endstücke



MOD 0220

V2A	304	Gebürstet			
	INDOOR*		Ø	H	d
	130220-020		20	ca. 18,5	M6
	130220-025		25	ca. 23,5	M8
	130220-030		30	ca. 28,5	M8
SELL OUT	130220-050		50	ca. 48,5	M8
V4A	316	Gebürstet			
	OUTDOOR				
SELL OUT	140220-020		20	ca. 18,5	M6
SELL OUT	140220-025		25	ca. 23,5	M8
SELL OUT	140220-040		40	ca. 38,5	M8

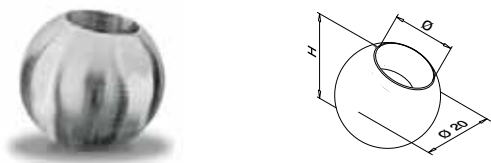

MOD 1221

V2A	304	Gebürstet			
	INDOOR*		Ø	H	
	131221-012		12	ca. 17,5	6
V4A	316	Gebürstet			
	OUTDOOR				
	141221-012		12	ca. 17,5	6



Q-INFO | MOD 0735

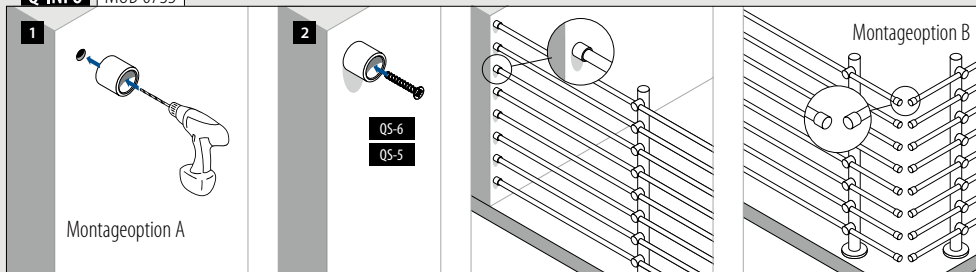

* Auch für Aussenanwendung geeignet bei entsprechenden Bedingungen.

SELL OUT Nur solange der Vorrat reicht.

Querstabhalter

Für flaches Rohr

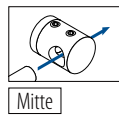
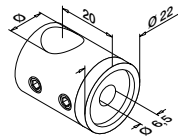

MOD 0830

V2A	304	Gebürstet			
INDOOR*			Ø		
130830-000-12	12	QS-15		472	4
V4A	316	Gebürstet			
OUTDOOR					
140830-000-12	12	QS-16		472	4



Für flaches Rohr

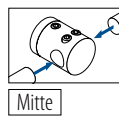
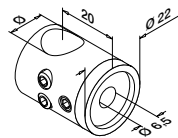

MOD 0831

V2A	304	Gebürstet			
INDOOR*			Ø		
130831-000-12	12	QS-15		472	4
V4A	316	Gebürstet			
OUTDOOR					
140831-000-12	12	QS-16		472	4



Für flaches Rohr

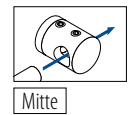
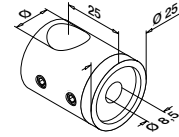

MOD 0840

V2A	304	Gebürstet			
INDOOR*			Ø		
130840-000-12	16	QS-19		472	4



Für flaches Rohr

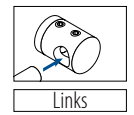
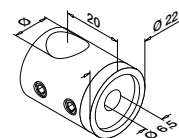

MOD 0832

V2A	304	Gebürstet			
INDOOR*			Ø		
130832-000-12	12	QS-15		472	4

V4A	316	Gebürstet			
OUTDOOR					
140832-000-12	12	QS-16		472	4



Für flaches Rohr

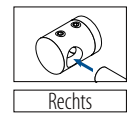
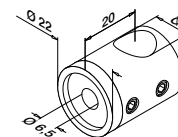

MOD 0833

V2A	304	Gebürstet			
INDOOR*			Ø		
130833-000-12	12	QS-15		472	4

V4A	316	Gebürstet			
OUTDOOR					
140833-000-12	12	QS-16		472	4



FÜLLUNGEN - STAB UND ROHR

PFROSTGELÄNDERSYSTEME

Q-INFO MOD 0830 / 0831 / 0840

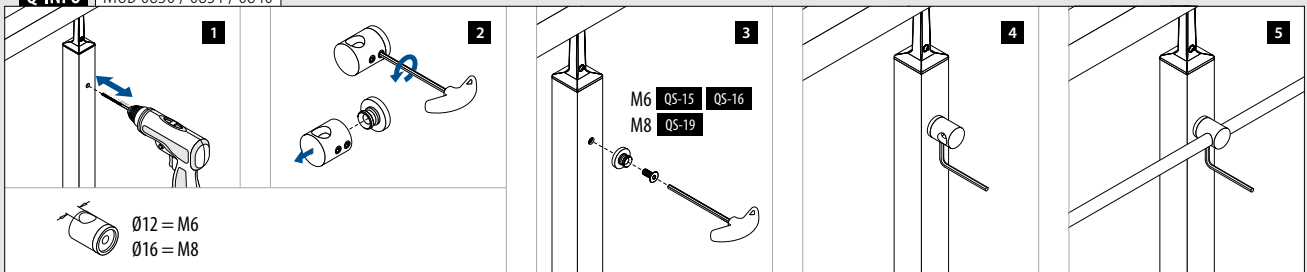

Querstabhalter

Für rundes Rohr

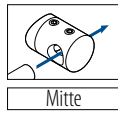
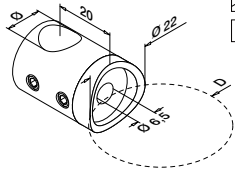

MOD 0830

V2A	304	Gebürstet				
INDOOR*			D	Ø		
SELL OUT	130830-033-12		33,7	12	QS-15	4
	130830-042-12		42,4	12	QS-15	4
SELL OUT	130830-048-12		48,3	12	QS-15	4
V4A	316	Gebürstet				
OUTDOOR			D	Ø		
	140830-042-12		42,4	12	QS-16	4
	140830-048-12		48,3	12	QS-16	4



Für rundes Rohr

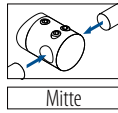
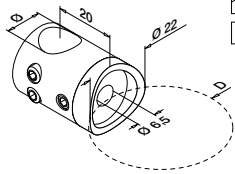

MOD 0831

V2A	304	Gebürstet				
INDOOR*			D	Ø		
SELL OUT	130831-033-12		33,7	12	QS-15	4
	130831-042-12		42,4	12	QS-15	4
SELL OUT	130831-048-12		48,3	12	QS-15	4
V4A	316	Gebürstet				
OUTDOOR			D	Ø		
	140831-042-12		42,4	12	QS-16	4
	140831-048-12		48,3	12	QS-16	4
V4A	316	Hochglanzpoliert				
OUTDOOR			D	Ø		
	140831-042-10		42,4	12	QS-16	4

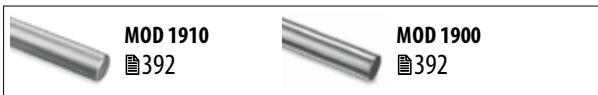

Für rundes Rohr

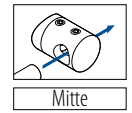
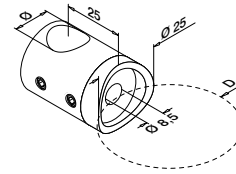

MOD 0840

V2A	304	Gebürstet				
INDOOR*			D	Ø		
	130840-042-12		42,4	16	QS-19	4
V4A	316	Gebürstet				
OUTDOOR			D	Ø		
	140840-042-12		42,4	16	QS-20	4
	140840-048-12		48,3	16	QS-20	4



Für rundes Rohr

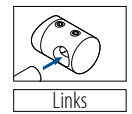
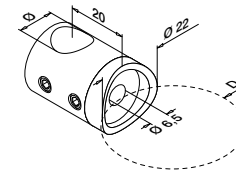

MOD 0832

V2A	304	Gebürstet				
INDOOR*			D	Ø		
SELL OUT	130832-033-12		33,7	12	QS-15	4
	130832-042-12		42,4	12	QS-15	4
SELL OUT	130832-048-12		48,3	12	QS-15	4
V4A	316	Gebürstet				
OUTDOOR			D	Ø		
	140832-042-12		42,4	12	QS-16	4



Für rundes Rohr

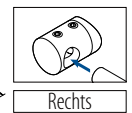
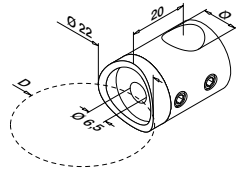

MOD 0833

V2A	304	Gebürstet				
INDOOR*			D	Ø		
SELL OUT	130833-033-12		33,7	12	QS-15	4
	130833-042-12		42,4	12	QS-15	4
SELL OUT	130833-048-12		48,3	12	QS-15	4
V4A	316	Gebürstet				
OUTDOOR			D	Ø		
	140833-042-12		42,4	12	QS-16	4



* Auch für Aussenanwendung geeignet bei entsprechenden Bedingungen.

Nur solange der Vorrat reicht.

Q-INFO | 304 | 316

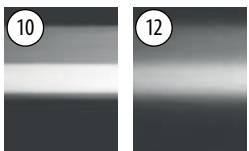

Hochglanzpoliert

Gebürstet

Querstabhalter

Für rundes Rohr

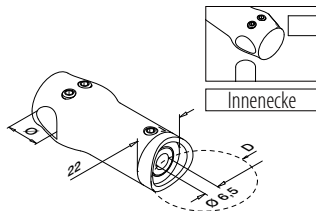

MOD 0834

V2A	304	Gebürstet			
INDOOR*			D	Ø	
	130834-042-12		42,4	12	QS-15 472 4
SELL OUT	130834-048-12		48,3	12	QS-15 472 4
V4A	316	Gebürstet			
OUTDOOR			D	Ø	
	140834-042-12		42,4	12	QS-16 472 4
	140834-048-12		48,3	12	QS-16 472 4



Internationaler Geschmacksmusterschutz

Für rundes Rohr

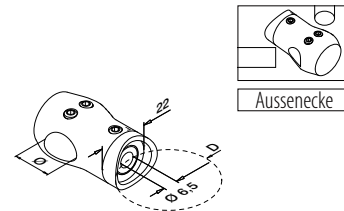

MOD 0839

V2A	304	Gebürstet			
INDOOR*			D	Ø	
	130839-042-12		42,4	12	QS-15 472 4
SELL OUT	130839-048-12		48,3	12	QS-15 472 4
V4A	316	Gebürstet			
OUTDOOR			D	Ø	
	140839-042-12		42,4	12	QS-16 472 4
	140839-048-12		48,3	12	QS-16 472 4



Internationaler Geschmacksmusterschutz

Glasadapter

Ø 25 mm

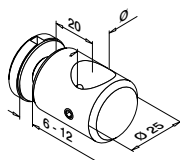

MOD 0755

V2A	304	Gebürstet		
INDOOR*		Ø		
SELL OUT	130755-16	16	4	
V4A	316	Gebürstet		
OUTDOOR		Ø		
SELL OUT	140755-12	12	4	



Querstabhalter

Stabmontage

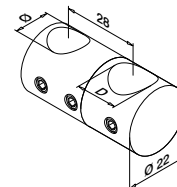

MOD 0827

V2A	304	Gebürstet			
INDOOR*			D	Ø	
	130827-012		12	12	4
	130827-016		16	12	4



* Auch für Aussenanwendung geeignet bei entsprechenden Bedingungen.

SELL OUT Nur solange der Vorrat reicht.

Q-INFO | MOD 0834 / 0839

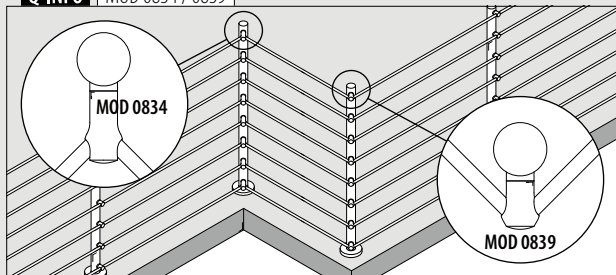

Q-INFO | MOD 0755

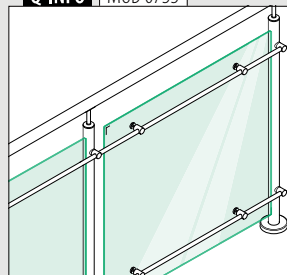

Q-INFO | MOD 0827

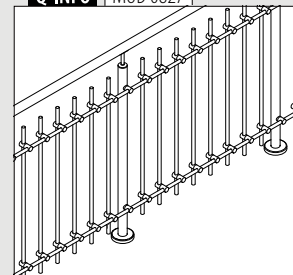

Stabhalter

Für flaches Rohr

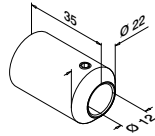

MOD 0850

V2A	304	Gebürstet		
INDOOR*				
130850-000	QS-23	472		4
V4A	316	Gebürstet		
OUTDOOR				
SELL OUT	140850-000	QS-53	472	4



Für rundes Rohr

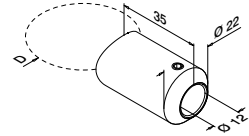

MOD 0850

V2A	304	Gebürstet		
INDOOR*				
130850-042	D	42,4	QS-23	472
4				
V4A	316	Gebürstet		
OUTDOOR				
140850-042	D	42,4	QS-53	472
4				



Stabhalter

Justierbar

Für flaches Rohr



-90°
+90°

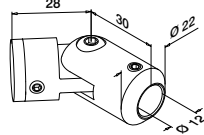

MOD 0855

V2A	304	Gebürstet		
INDOOR*				
130855-000	QS-15	472		4



Für rundes Rohr



-90°
+90°

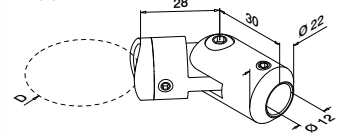

MOD 0855

V2A	304	Gebürstet		
INDOOR*				
130855-042	D	42,4	QS-15	472
4				



Q-INFO MOD 0850-042

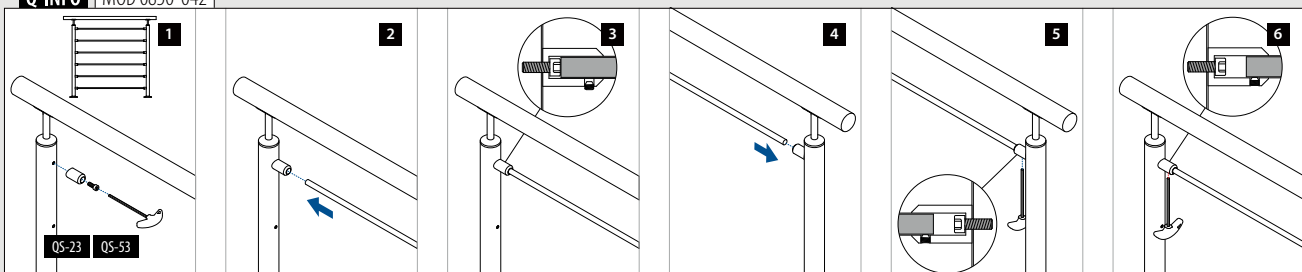



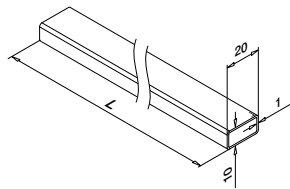

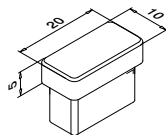

MOD 1940

V2A	304	Gebürstet		
INDOOR*				
131940-021-50-12	20 x 10 x 1,0		L = 5 m	
V4A	316	Gebürstet		
OUTDOOR				
141940-021-50-12	20 x 10 x 1,0		L = 5 m	
PREFIX				



MOD 1712



V2A	304	Gebürstet		
INDOOR*		Für Rohr □		
131712-021-12	20 x 10 x 1,0		4	
V4A	316	Gebürstet		
OUTDOOR				
141712-021-12	20 x 10 x 1,0		4	

 Internationaler Geschmacksmusterschutz

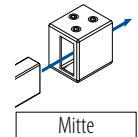
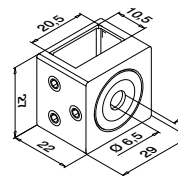
Für flaches Rohr



MOD 4827

V2A	304	Gebürstet		
INDOOR*		Für Rohr □		
134827-12	20 x 10 x 1,0	QS-15 	472	4
V4A	316	Gebürstet		
OUTDOOR				
144827-12	20 x 10 x 1,0	QS-16 	472	4

 Internationaler Geschmacksmusterschutz

* Auch für Aussenanwendung geeignet bei entsprechenden Bedingungen.

Q-INFO

Q-INFO MOD 1940

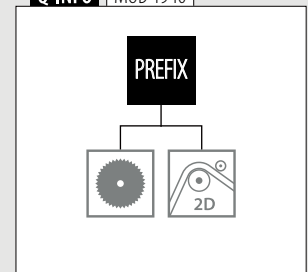
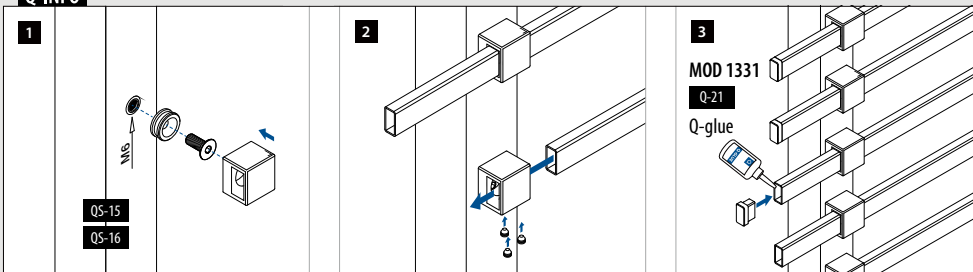



Rohre für Stabausfachung (vertikale Geländerfüllung)

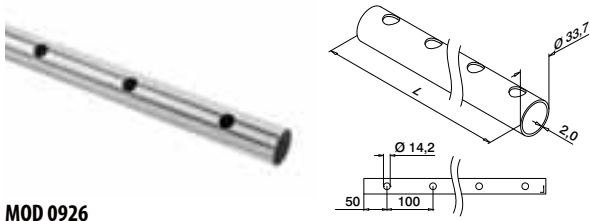

MOD 0926

V4A	316	Gebürstet
OUTDOOR		
140926-233-25-12	L = 2,5 m	



Adapter für Stabausfachung (vertikale Geländerfüllung)

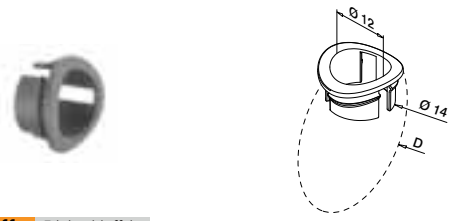

MOD 0521

	Kunststoff	Edelstahleffekt
OUTDOOR		
SELL OUT 150521	D	50

Stäbe für Stabausfachung (vertikale Geländerfüllung)

Q-TUBE



MOD 1910

V4A	316	Gebürstet
OUTDOOR		
141910-012-25-12	12	L = 2,5 m
141910-012-50-12	12	L = 5 m



Q-INFO MOD 0926

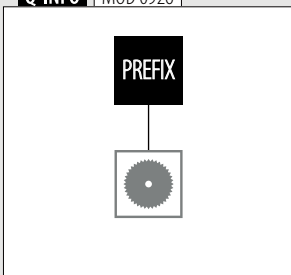

Q-INFO MOD 1910

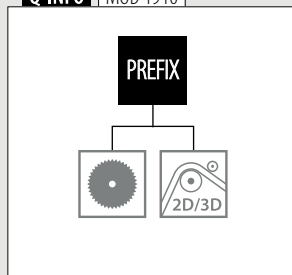

SELL OUT Nur solange der Vorrat reicht.

Q-INFO

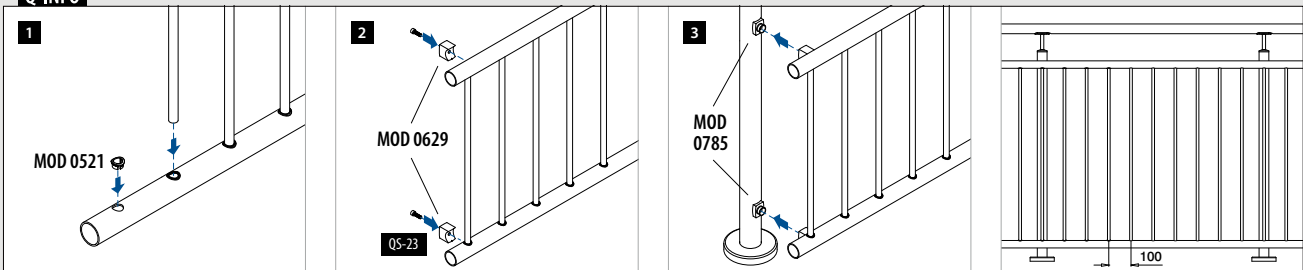

Rohradapter

Für rundes Rohr

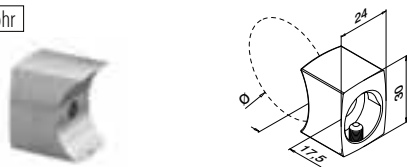

MOD 0629

V4A	316	Gebürstet		
OUTDOOR		Ø		
140629-033	33,7	QS-53	472	4
140629-042	42,4	QS-53	472	4



Internationaler Geschmacksmusterschutz

Adapter für Rohradapter MOD 0629

Für flaches Rohr



MOD 0785

V4A	316	Gebürstet		
OUTDOOR				
140785-000-12		QS-16	472	4



Für rundes Rohr

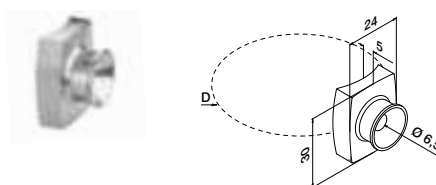

MOD 0785

V4A	316	Gebürstet		
OUTDOOR		D		
140785-042-12	42,4	QS-16	472	4
140785-048-12	48,3	QS-16	472	4



Verbinder

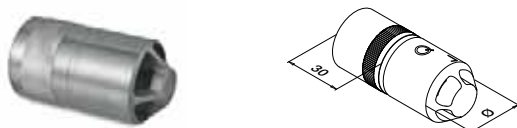

MOD 5792 - EASY HIT®

V4A	316	Roh		
OUTDOOR		Für Rohr Ø		
145792-233		33,7 x 2,0		2



Internationaler Geschmacksmusterschutz

Q-INFO | MOD 5792

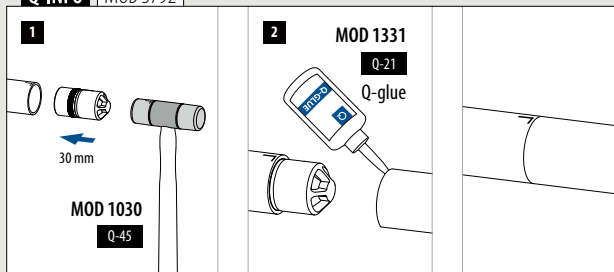

Nur solange der Vorrat reicht.

Endkappen

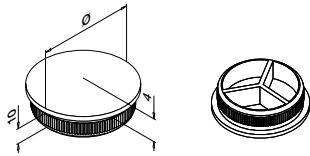

MOD 5729 - EASY HIT®

V4A	316	Gebürstet		
	OUTDOOR		Für Rohr Ø	
145729-233-12			33,7 x 2,0	2

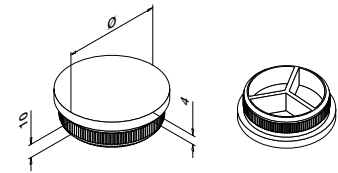

MOD 5732 - EASY HIT®

V4A	316	Gebürstet		
	OUTDOOR		Für Rohr Ø	
145732-233-12			33,7 x 2,0	2



Wandflansche

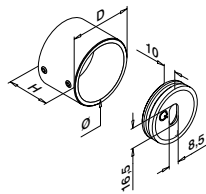

MOD 0504

V4A	316	Gebürstet					
	OUTDOOR		Ø	D	H		
140504-033-12			33,7	41	30	QS-55 470 / QS-22 472	2



Q-INFO MOD 0504

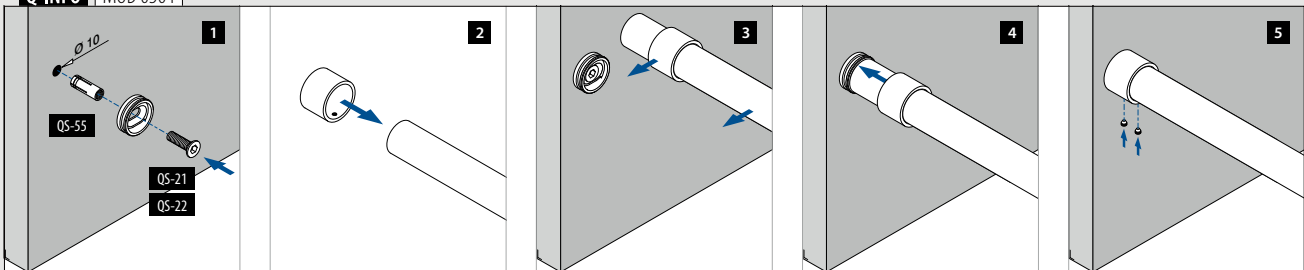



Finden Sie alle
Informationen zu
Drahtseifüllungen online:

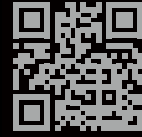

g-ne.ws/lnfills23

FÜLLUNGEN - DRAHTSEIL

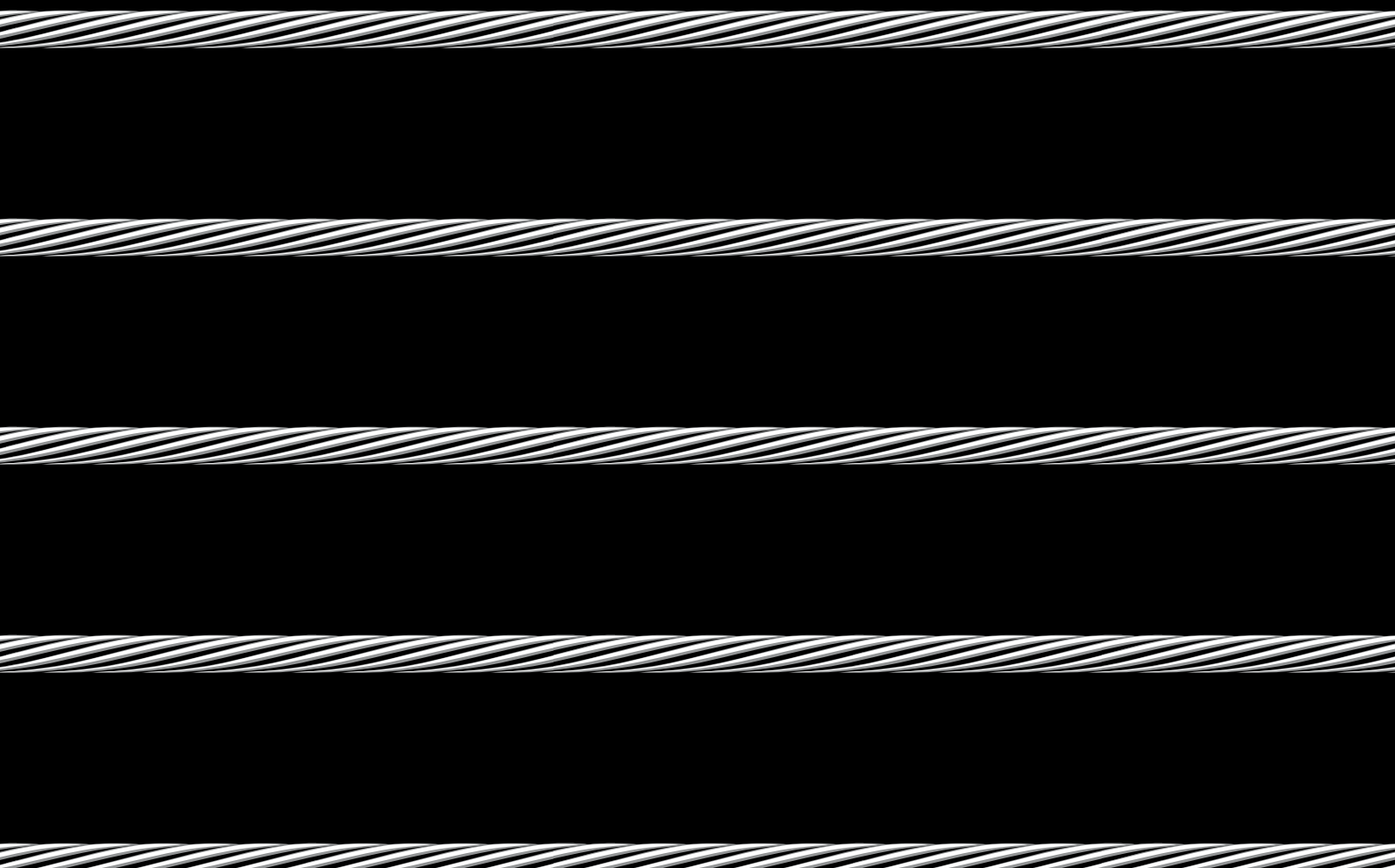

Füllungen

Drahtseilsystem, 3,2 mm

Komplettes Set

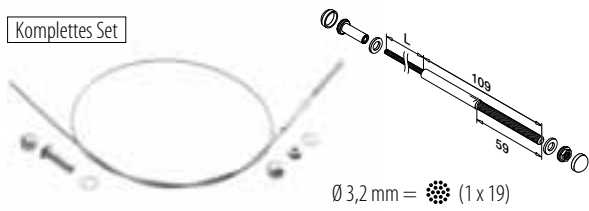

Ø 3,2 mm = (1 x 19)

MOD 7901

V4A	316	Gebürstet	OUTDOOR	Kabel Ø	
147901-003-01	3,2	L = 1 m			
147901-003-02	3,2	L = 2,5 m			
147901-003-05	3,2	L = 5 m			
147901-003-07	3,2	L = 7,5 m			
147901-003-10	3,2	L = 10 m			
147901-003-12	3,2	L = 12,5 m			
147901-003-20	3,2	L = 20 m			

Füllungen

Endkappen

Für MOD 7240

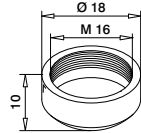

MOD 7245

V4A	316	Gebürstet	OUTDOOR	
147245				8

Füllungen

Entriegelungswerkzeug



MOD 7802

V4A	316	Gebürstet	OUTDOOR	Für Kabel Ø	
207802-003				3,2	1

Füllungen

Adapter

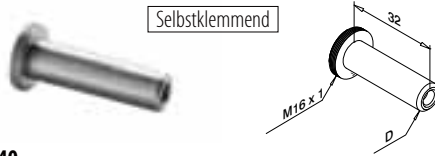

MOD 7240

V4A	316	Gebürstet	OUTDOOR	Für Kabel Ø	D	
147240-003				3,2	9,3	2

Internationaler Geschmacksmusterschutz

Füllungen

Drahtseilstopper

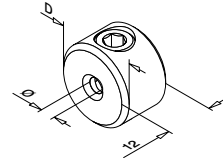

MOD 7400

V4A	316	Gebürstet	OUTDOOR	Für Kabel Ø	D	
147400-003				3,2 - 4,0	18	6



Q-INFO MOD 7400

Bitte benutzen Sie immer einen Drahtseilstopper, um die Kräfte auf den nächsten Geländerpfosten zu übertragen!

Q-INFO MOD 7901-003

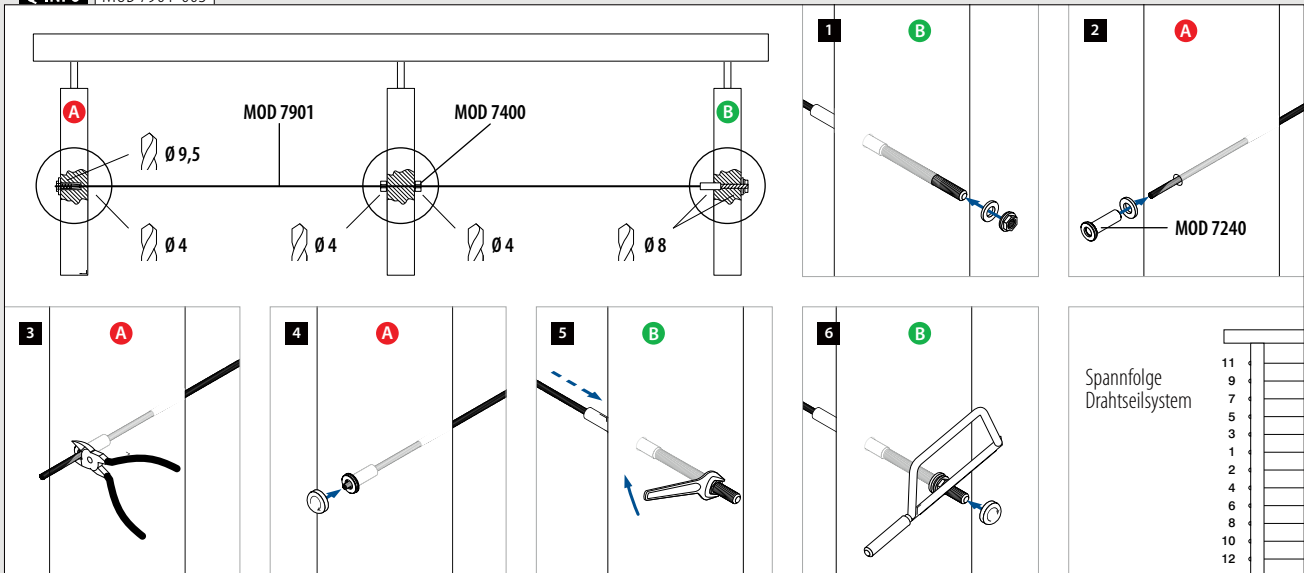

Füllungen

Drahtseilsystem, 4,0 mm

Komplettes Set

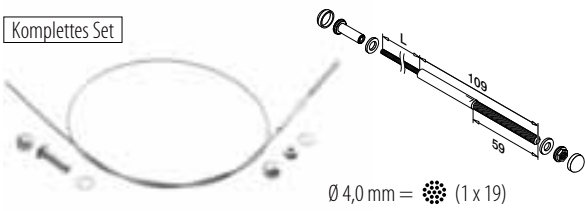

Ø 4,0 mm = (1 x 19)

MOD 7901

V4A	316	Gebürstet	OUTDOOR	Kabel Ø	
147901-004-01	4,0	L = 1 m			
147901-004-02	4,0	L = 2,5 m			
147901-004-05	4,0	L = 5 m			
147901-004-07	4,0	L = 7,5 m			
147901-004-10	4,0	L = 10 m			
147901-004-12	4,0	L = 12,5 m			
147901-004-20	4,0	L = 20 m			

Füllungen

Endkappen

Für MOD 7240

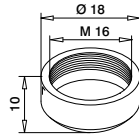

MOD 7245

V4A	316	Gebürstet	OUTDOOR	
147245				8

Füllungen

Entriegelungswerkzeug



MOD 7802

V4A	316	Gebürstet	OUTDOOR	Für Kabel Ø	
207802-004				4,0	1

Füllungen

Adapter



Selbstklemmend

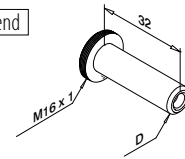

MOD 7240

V4A	316	Gebürstet	OUTDOOR	Für Kabel Ø	D	
147240-004				4,0	11,3	2

Internationaler Geschmacksmusterschutz

Füllungen

Drahtseilstopper

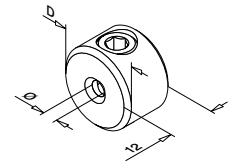

MOD 7400

V4A	316	Gebürstet	OUTDOOR	Für Kabel Ø	D	
147400-003				3,2 - 4,0	18	6



Q-INFO MOD 7400 / 7401

Bitte benutzen Sie immer einen Drahtseilstopper, um die Kräfte auf den nächsten Geländerpfeiler zu übertragen!

Q-INFO MOD 7901-004

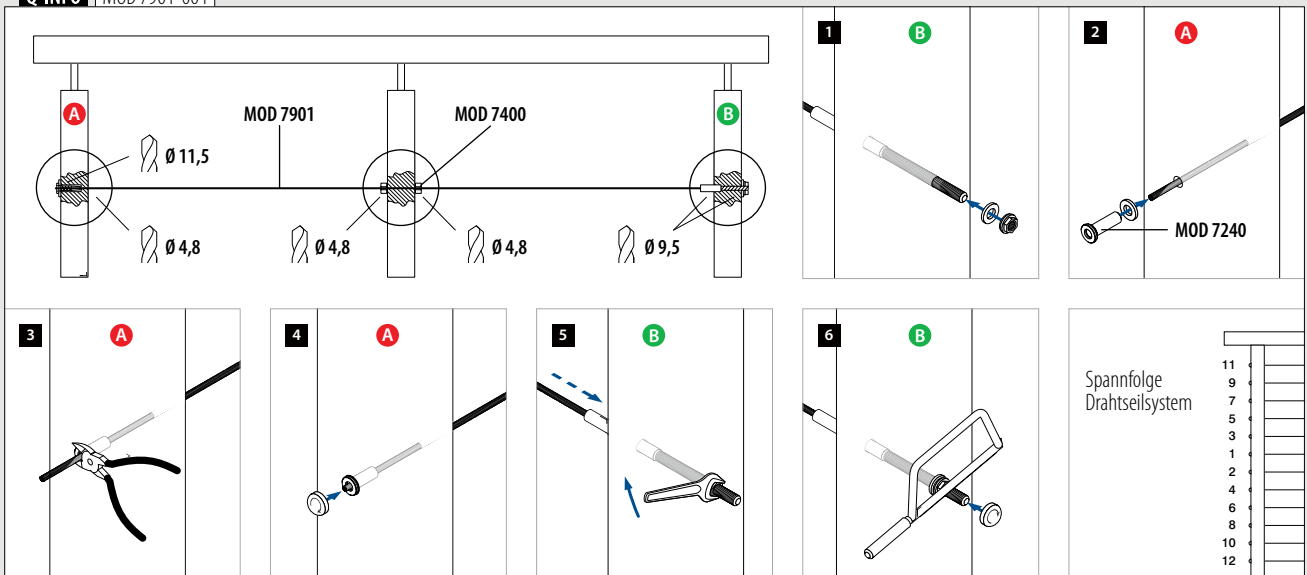

Drahtseilstopper zur diagonalen Montage

Für flaches Rohr

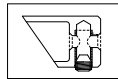
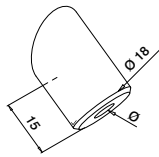

Abwärts
+/- 35°

MOD 7401

V2A	304	Gebürstet		
	INDOOR		Für Kabel Ø	
	137401-000-02		3,2 - 4,0	6
V4A	316	Gebürstet		
	OUTDOOR			
	147401-000-02		3,2 - 4,0	6



Für rundes Rohr

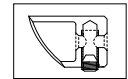
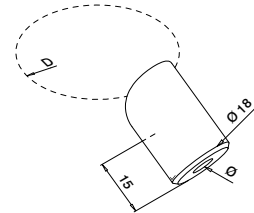

Abwärts
+/- 35°

MOD 7401

V2A	304	Gebürstet		
	INDOOR		D	Für Kabel Ø
	137401-042-02		42,4	3,2 - 4,0
V4A	316	Gebürstet		
	OUTDOOR			
	147401-042-02		42,4	3,2 - 4,0



Für flaches Rohr

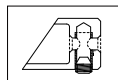
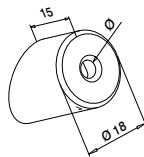

Aufwärts
+/- 35°

MOD 7401

V2A	304	Gebürstet		
	INDOOR		Für Kabel Ø	
	137401-000-01		3,2 - 4,0	6
V4A	316	Gebürstet		
	OUTDOOR			
	147401-000-01		3,2 - 4,0	6



Für rundes Rohr

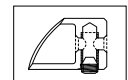
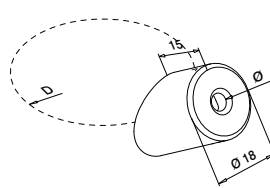

Aufwärts
+/- 35°

MOD 7401

V2A	304	Gebürstet		
	INDOOR		D	Für Kabel Ø
	137401-042-01		42,4	3,2 - 4,0
V4A	316	Gebürstet		
	OUTDOOR			
	147401-042-01		42,4	3,2 - 4,0



Adapter zur diagonalen Installation

Für flaches Rohr

Oben und unten

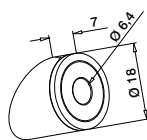

+/- 35°

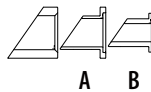

MOD 7403

V2A	304	Gebürstet		
	INDOOR		Für Kabel Ø	
	137403-000		3,2 - 4,0	6
V4A	316	Gebürstet		
	OUTDOOR			
	147403-000		3,2 - 4,0	6

Internationaler Geschmacksmusterschutz

Für rundes Rohr

Oben und unten

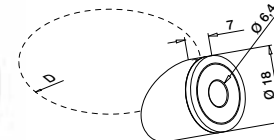

+/- 35°

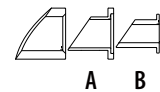

MOD 7403

V2A	304	Gebürstet		
	INDOOR		D	Für Kabel Ø
	137403-042		42,4	3,2 - 4,0
V4A	316	Gebürstet		
	OUTDOOR			
	147403-042		42,4	3,2 - 4,0

Internationaler Geschmacksmusterschutz

Q-INFO MOD 7403

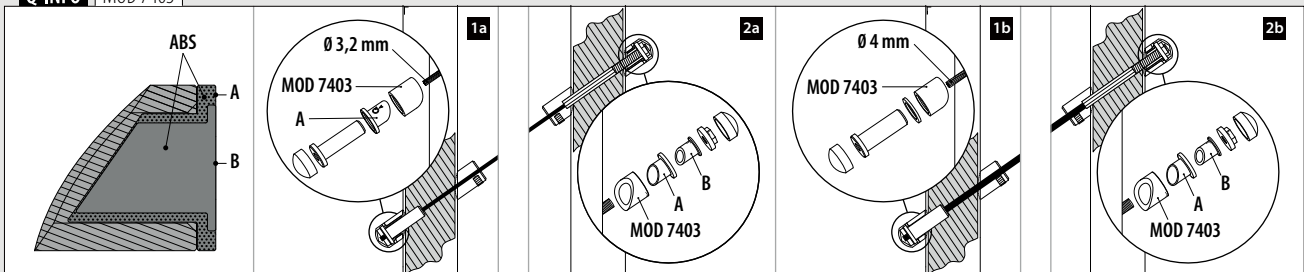

Spanner

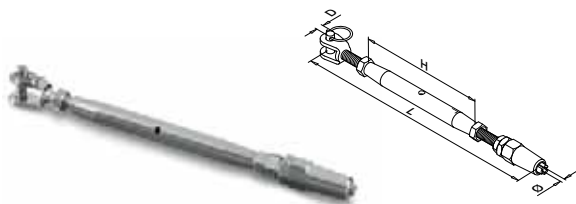

MOD 7250

V2A	304	Gebürstet				
INDOOR	Für Kabel Ø	D	H	L		
137250-003	3,2	5	90	155 - 230	2	
137250-006	6,0	9	125	270 - 325	2	

V4A	316	Gebürstet				
OUTDOOR	Für Kabel Ø	D	H	L		
147250-003	3,2	5	90	155 - 230	2	
147250-006	6,0	9	125	270 - 325	2	



Drahtseil

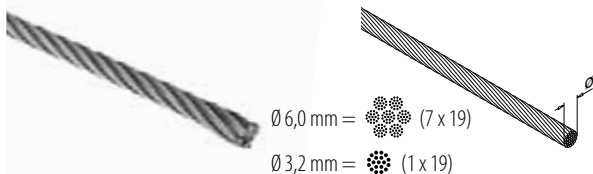

MOD 7900

V2A	304	Gebürstet		
INDOOR	Ø	L		
137900-003-10	3,2	L = 10 m		
137900-003-50	3,2	L = 50 m		
137900-003-01	3,2	L = 100 m		

SELL OUT	304	Gebürstet		
SELL OUT	INDOOR	Ø	L	
	137900-006-10	6,0	L = 10 m	
	137900-006-50	6,0	L = 50 m	
	137900-006-01	6,0	L = 100 m	

V4A	316	Gebürstet		
OUTDOOR	Ø	L		
	147900-003-10	3,2	L = 10 m	
	147900-003-50	3,2	L = 50 m	
	147900-003-01	3,2	L = 100 m	
	147900-006-10	6,0	L = 10 m	
	147900-006-50	6,0	L = 50 m	
	147900-006-01	6,0	L = 100 m	

SELL OUT Nur solange der Vorrat reicht.

Q-INFO | MOD 7400

Bitte benutzen Sie immer einen Drahtseilstopper, um die Kräfte auf den nächsten Geländerpfosten zu übertragen!

Q-INFO | MOD 7900-006

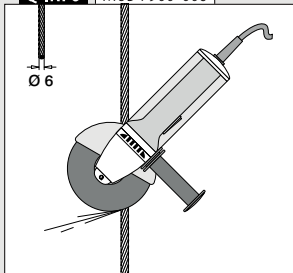

Q-INFO

Drahtseil-Schere



MOD 7800

485

Endstück



MOD 7300

V2A	304	Gebürstet				
INDOOR	Für Kabel Ø	D	L			
137300-003	3,2	5	50		2	
137300-006	6,0	9	97		2	

V4A	316	Gebürstet				
OUTDOOR	Für Kabel Ø	D	L			
147300-003	3,2	5	50		2	
147300-006	6,0	9	97		2	



Augenschrauben

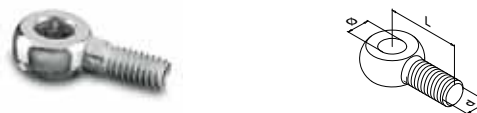

MOD 7350

V2A	304	Gebürstet				
INDOOR	d	Ø	Für Kabel Ø	L		
137350-619	M6	6	3,2	19	10	
137350-130	M10	9	6,0	30	10	

V4A	316	Gebürstet				
OUTDOOR	d	Ø	Für Kabel Ø	L		
147350-619	M6	6	3,2	19	10	
147350-130	M10	9	6,0	30	10	

Drahtseilstopper

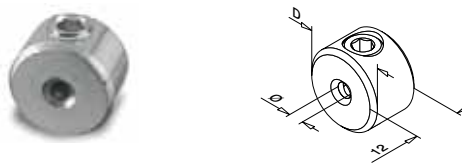

MOD 7400

V2A	304	Gebürstet			
INDOOR	Für Kabel Ø	D			
137400-003	3,2	18		6	
137400-006	6,0	20		6	

V4A	316	Gebürstet			
OUTDOOR	Für Kabel Ø	D			
147400-003	3,2	18		6	
147400-006	6,0	20		6	



Q-INFO

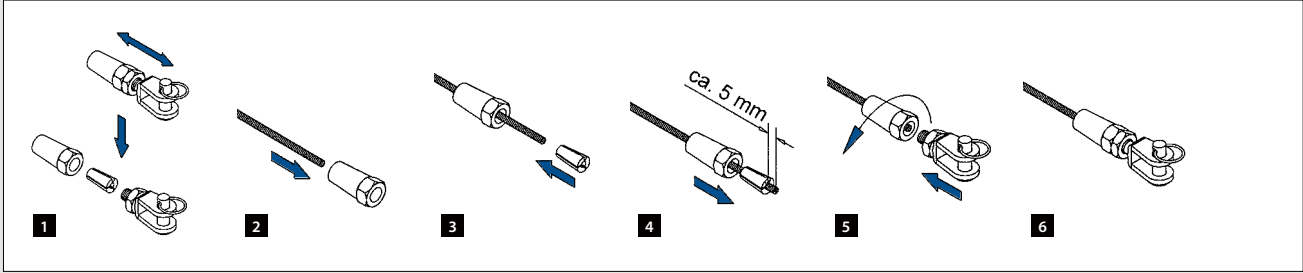

Q-INFO

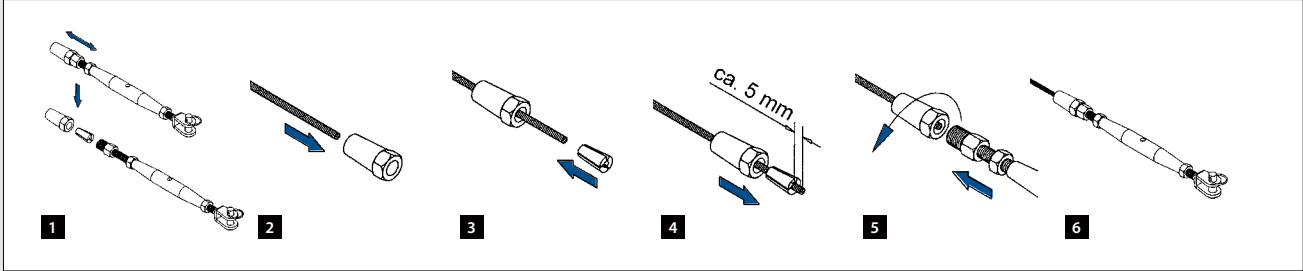

Q-INFO

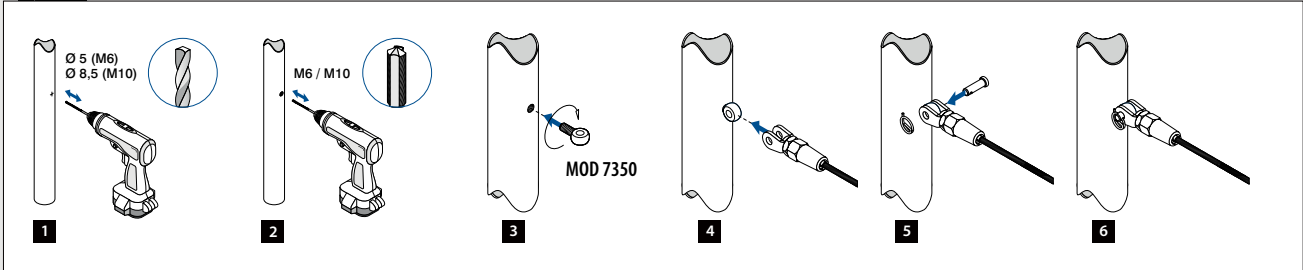

Q-INFO

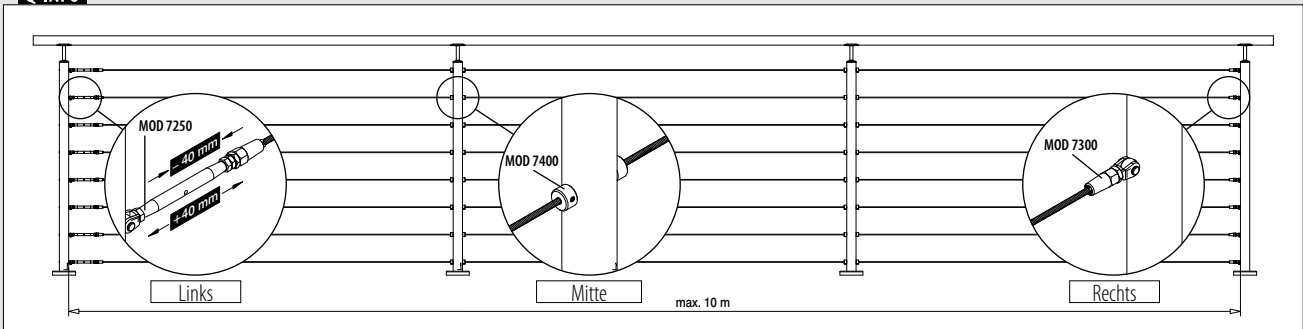

Drahtseilstopper zur diagonalen Montage

Für flaches Rohr

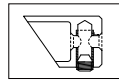
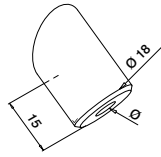

Abwärts
+/- 35°

MOD 7401

V2A	304	Gebürstet		
INDOOR			Für Kabel Ø	
137401-000-02			3,2	6
V4A	316	Gebürstet		
OUTDOOR				
147401-000-02			3,2	6



Für rundes Rohr

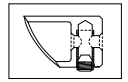
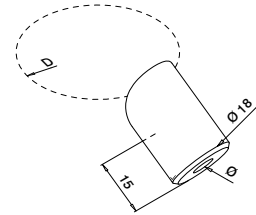

Abwärts
+/- 35°

MOD 7401

V2A	304	Gebürstet		
INDOOR			D	Für Kabel Ø
137401-042-02			42,4	3,2
137401-042-02			42,4	6
V4A	316	Gebürstet		
OUTDOOR				
147401-042-02			42,4	3,2
147401-042-02			42,4	6



Für flaches Rohr

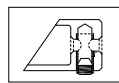
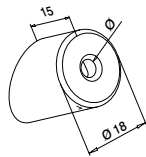

Aufwärts
+/- 35°

MOD 7401

V2A	304	Gebürstet		
INDOOR			Für Kabel Ø	
137401-000-01			3,2	6
V4A	316	Gebürstet		
OUTDOOR				
147401-000-01			3,2	6



Für rundes Rohr

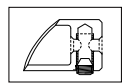
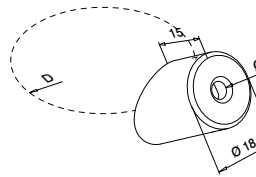

Aufwärts
+/- 35°

MOD 7401

V2A	304	Gebürstet		
INDOOR			D	Für Kabel Ø
137401-042-01			42,4	3,2
137401-042-01			42,4	6
V4A	316	Gebürstet		
OUTDOOR				
147401-042-01			42,4	3,2
147401-042-01			42,4	6



Q-INFO | MOD 7250 / 7401-042 / 7300

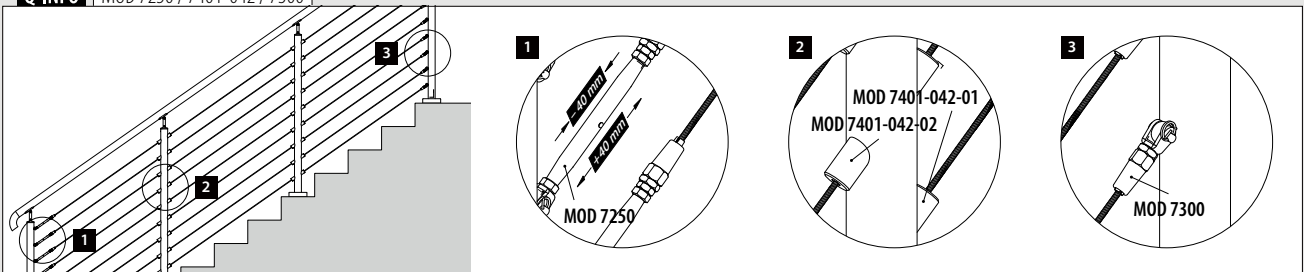

Drahtseilhalter

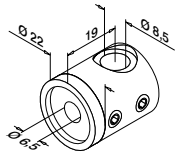

Für flaches Rohr
Links

MOD 7450

V2A	304	Gebürstet		
INDOOR				
137450-000-01	QS-15	472		4

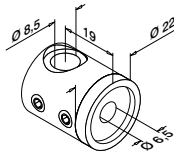

Für flaches Rohr
Rechts

MOD 7450

V2A	304	Gebürstet		
INDOOR				
137450-000-02	QS-15	472		4

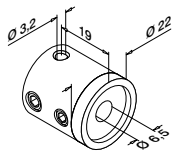

Für flaches Rohr
Mitte

MOD 7450

V2A	304	Gebürstet		
INDOOR				
137450-000-00	QS-15	472		4

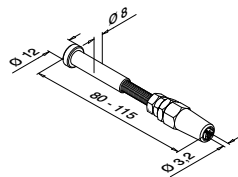

MOD 7500

V2A	304	Gebürstet		
INDOOR				
137500				4

V4A	316	Gebürstet		
OUTDOOR				
147500				4

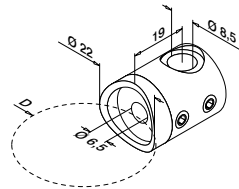

Für rundes Rohr
Links

MOD 7450

V2A	304	Gebürstet		
INDOOR				
137450-042-01	D		QS-15	472
	42,4			4

V4A	316	Gebürstet		
OUTDOOR				
147450-042-01	D		QS-16	472
	42,4			4

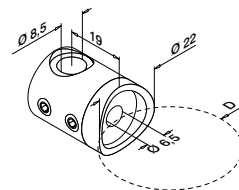

Für rundes Rohr
Rechts

MOD 7450

V2A	304	Gebürstet		
INDOOR				
137450-042-02	D		QS-15	472
	42,4			4

V4A	316	Gebürstet		
OUTDOOR				
147450-042-02	D		QS-16	472
	42,4			4

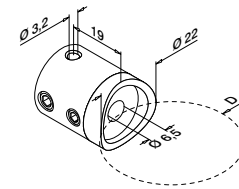

Für rundes Rohr
Mitte

MOD 7450

V2A	304	Gebürstet		
INDOOR				
137450-042-00	D		QS-15	472
	42,4			4

V4A	316	Gebürstet		
OUTDOOR				
147450-042-00	D		QS-16	472
	42,4			4



Q-INFO | MOD 7450 / 7500 / 7900

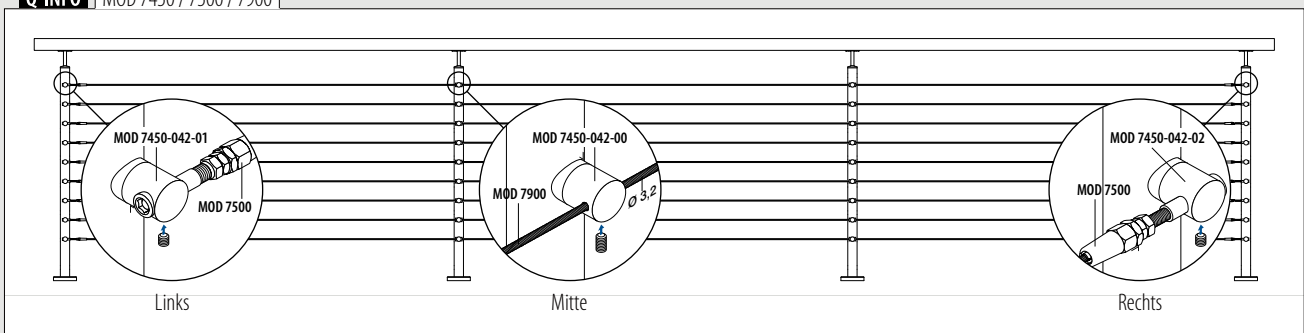



Finden Sie alle
Informationen zu
Netzfüllungen online:



<https://q-ne.ws/QWeb23>

FÜLLUNGEN - NETZ

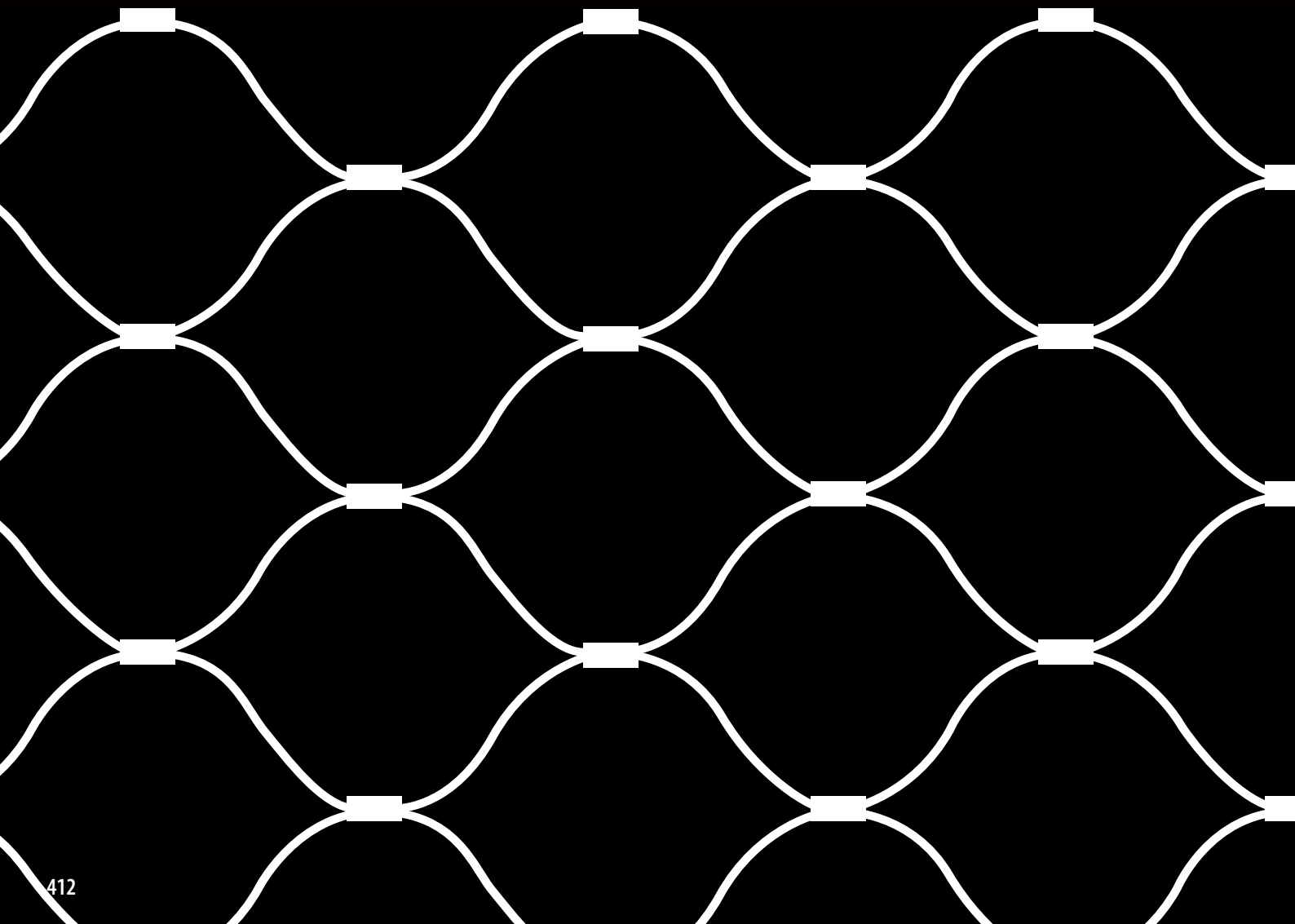

Füllungen

Drahtseil

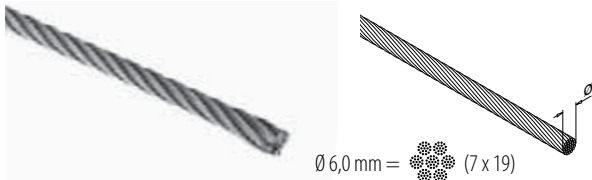

Ø 6,0 mm = (7 x 19)

MOD 7900

V4A	316	Gebürstet		
OUTDOOR		Ø		
147900-006-10	6,0		L = 10 m	
147900-006-50	6,0		L = 50 m	
147900-006-01	6,0		L = 100 m	

Füllungen

Drahtseilspanner



MOD 7260

V4A	316	Gebürstet			
OUTDOOR		Ø	H	L	
147260-006	6		125	340-360	2

Füllungen

Adapter

Für flaches Rohr



MOD 7723

V4A	316	Gebürstet	
OUTDOOR			
147723-000			12

Für rundes Rohr

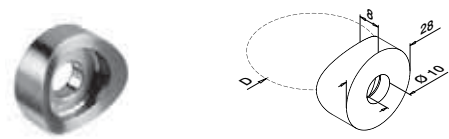

MOD 7723

V4A	316	Gebürstet		
OUTDOOR		D		
147723-042		42,4		12
147723-048		48,3		12

Füllungen

Drahtseilhalter

Für rundes Rohr

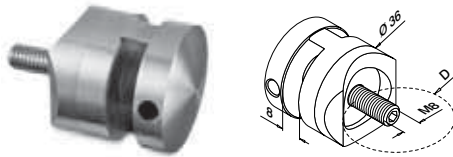

MOD 7356

V4A	316	Gebürstet		
OUTDOOR		D		
147356-042		42,4		2



Füllungen

Augenschrauben

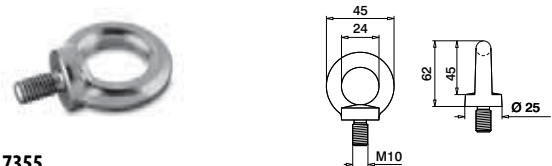

MOD 7355

V4A	316	Gebürstet	
OUTDOOR			
147355-010			12

Zubehör

Kabelbinder



MOD 1050

	Zubehör			
	Q	L		
201050	Q-50	300		100

Q-INFO MOD 7900-006

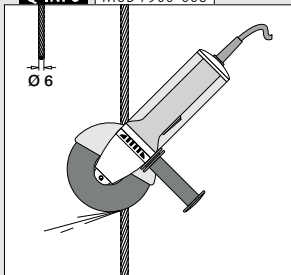

Q-INFO MOD 7356-042

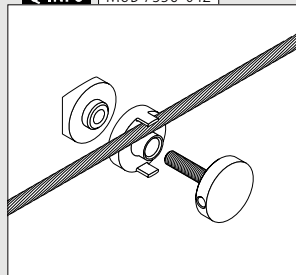

Q-INFO MOD 7355 / 7723

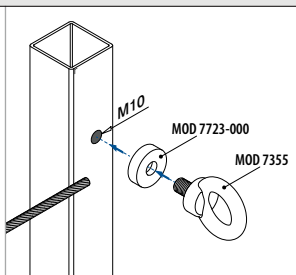
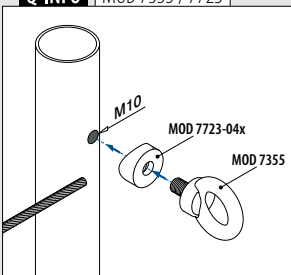

Füllungen

Netze / Q-web

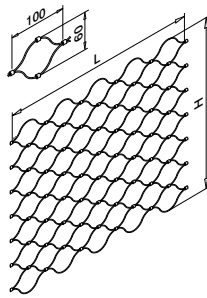
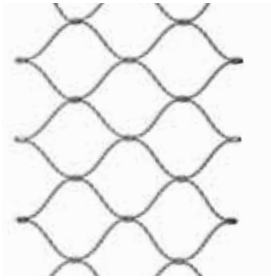

MOD 7910

V4A	316	Gebürstet		
OUTDOOR		H		
147910-050-06	600	L = 5 m		
147910-100-06	600	L = 10 m		
147910-500-06	600	L = 50 m		
147910-050-08	800	L = 5 m		
147910-100-08	800	L = 10 m		
147910-500-08	800	L = 50 m		

Füllungen

Drahtseil

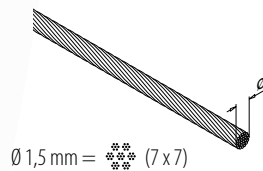

MOD 7911

V4A	316	Gebürstet		
OUTDOOR		Ø		
147911-100	1,5	L = 10 m		
147911-500	1,5	L = 50 m		
147911-001	1,5	L = 100 m		

Füllungen

Netzverbinder

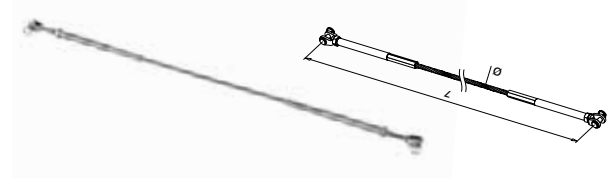

MOD 7780

V4A	316	Gebürstet		
OUTDOOR		Ø	L	
147780	8	800		1

Füllungen

Schrägklemme

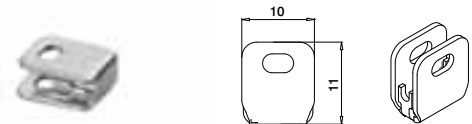

MOD 7810

V4A	316	Gebürstet		
OUTDOOR				
147810				12

Füllungen

Vertikalklemme



MOD 7820

V4A	316	Gebürstet		
OUTDOOR				
147820				12

Internationaler Geschmacksmusterschutz

Füllungen

Verbinder

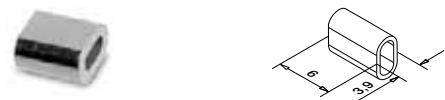

MOD 7830

V4A	316	Gebürstet		
OUTDOOR				
147830				12

Q-INFO | MOD 7260 / 7810 / 7820

Benötigte Menge

MOD 7260		1x pro 10 Meter
MOD 7810		20 Stück pro Meter (10x oben und 10x unten)
MOD 7820	H = 600 mm	10 Stück jede Seite (links und rechts)
	H = 800 mm	13 Stück jede Seite (links und rechts)





Finden Sie alle
Informationen zu
Blechfüllungen online:

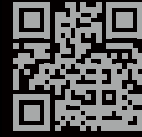

q-ne.ws/lnfills23

PRODUKTE FÜR FÜLLUNGEN - BLECH

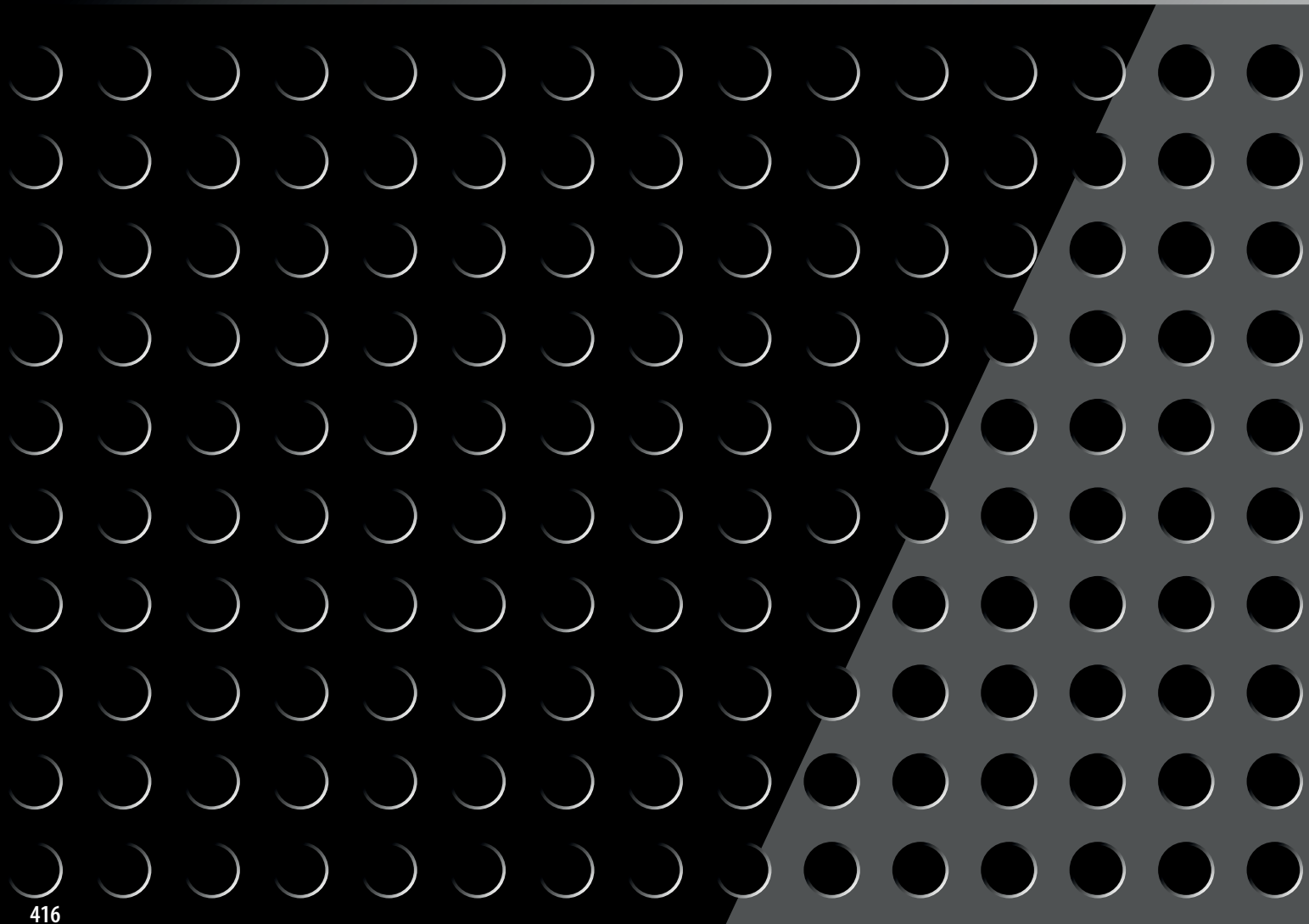

Blechadapter - MOD 2800

Für flaches Rohr

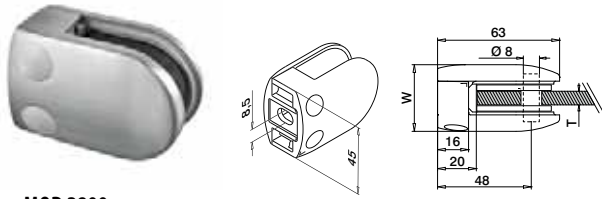

Für rundes Rohr

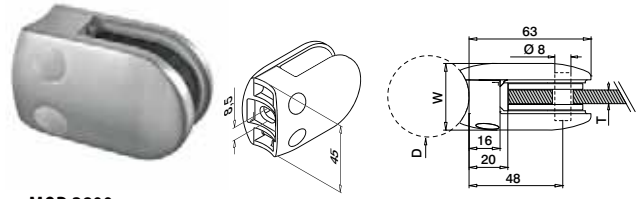

MOD 2800

V2A	304	Gebürstet				
INDOOR*			W	T		
	132800-000-12	34	Siehe MOD 5028	QS-26		474 4
V2A	304	Hochglanzpoliert				
INDOOR*						
	132800-000-10	34	Siehe MOD 5028	QS-26		474 4
V4A	316	Gebürstet				
OUTDOOR						
	142800-000-12	34	Siehe MOD 5028	QS-27		474 4
V4A	316	Hochglanzpoliert				
OUTDOOR						
	142800-000-10	34	Siehe MOD 5028	QS-27		474 4
V4A	316	Black Line				
OUTDOOR						
	142800-000-82	34	Siehe MOD 5028	QS-27		474 4
Zinkdruckguss						
INDOOR						
	102800-000-...	36	Siehe MOD 5028	QS-28		474 4



Internationaler Geschmacksmusterschutz

MOD 2800

V2A	304	Gebürstet					
INDOOR*			D	W	T		
	132800-042-12	42,4	34	Siehe MOD 5028	QS-47		474 4
	132800-048-12	48,3	34	Siehe MOD 5028	QS-47		474 4
V2A	304	Hochglanzpoliert					
INDOOR*							
	132800-042-10	42,4	34	Siehe MOD 5028	QS-47		474 4
	132800-048-10	48,3	34	Siehe MOD 5028	QS-47		474 4
V4A	316	Gebürstet					
OUTDOOR							
	142800-042-12	42,4	34	Siehe MOD 5028	QS-45		474 4
	142800-048-12	48,3	34	Siehe MOD 5028	QS-45		474 4
V4A	316	Hochglanzpoliert					
OUTDOOR							
	142800-042-10	42,4	34	Siehe MOD 5028	QS-45		474 4
	142800-048-10	42,4	34	Siehe MOD 5028	QS-45		474 4
Zinkdruckguss							
INDOOR							
	102800-042-...	42,4	36	Siehe MOD 5028	QS-46		474 4
	102800-048-...	48,3	36	Siehe MOD 5028	QS-46		474 4



Internationaler Geschmacksmusterschutz

Gummieinlagen für Blechadapter MOD 2800



2 Stück pro Blechadapter

MOD 5028

Zubehör

	T	
205028-02	2	8
205028-03	3	8
205028-04	4	8



Nur solange der Vorrat reicht.

Bitte bestellen Sie Befestigungsmaterial separat.

Q-INFO MOD 5015 / 2800

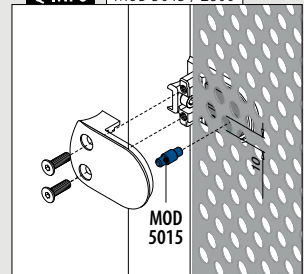

* Auch für Aussenanwendung geeignet bei entsprechenden Bedingungen.

Q-INFO 304 316 MOD 2800 Oberflächen

10	12	82 RAL 9005 Pulver- beschichtet
Hochglanz- poliert	Gebürstet	Schwarz, matt, strukturiert

Q-INFO Zinkdruckguss MOD 2800 Oberflächen

00	17	19	82 RAL 9005 Pulver- beschichtet	89 RAL 9005 Pulver- beschichtet INDOOR
Roh	Glanzverchromt	Edelstahleffekt	Schwarz, matt, strukturiert	Schwarz, matt, glatt
	102800-000-00	102800-000-17	102800-000-19	102800-000-89
	102800-04x-00	102800-04x-19	102800-04x-82	102800-04x-89

Q-INFO

00

Artikel mit .00-Ausführung können pulverbeschichtet werden.

Blechadapter - MOD 4200

Für flaches Rohr

Inklusive Sicherungsplatte

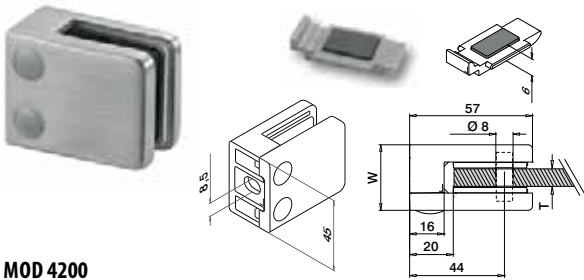

Für rundes Rohr

Inklusive Sicherungsplatte

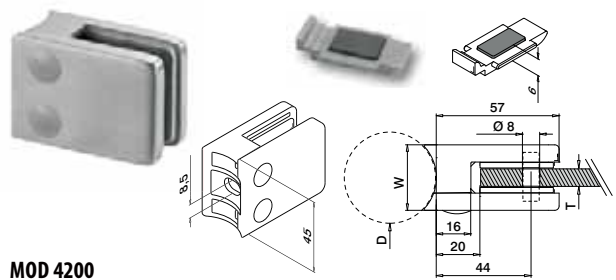

MOD 4200

V2A	304	Gebürstet				
INDOOR*		W	T			
	134200-000-12	28	Siehe MOD 5042	QS-26	474	4
V4A	316	Gebürstet				
OUTDOOR						
	144200-000-12	28	Siehe MOD 5042	QS-27	474	4
V4A	316	Black Line				
OUTDOOR						
NEW	144200-000-82	28	Siehe MOD 5042	QS-27	474	4
V4A	316	Hochglanzpoliert				
OUTDOOR						
	144200-000-10	28	Siehe MOD 5042	QS-27	474	4
Zinkdruckguss						
INDOOR						
SELL OUT	104200-000-...	30	Siehe MOD 5042	QS-28	474	4



Internationaler Geschmacksmusterschutz

MOD 4200

V2A	304	Gebürstet				
INDOOR*		D	W	T		
	134200-042-12	42,4	28	Siehe MOD 5042	QS-47	474 4
	134200-048-12	48,3	28	Siehe MOD 5042	QS-47	474 4
V2A	304	Black Line				
INDOOR*						
NEW	134200-042-82	42,4	28	Siehe MOD 5042	QS-47	474 4
V4A	316	Gebürstet				
OUTDOOR						
	144200-042-12	42,4	28	Siehe MOD 5042	QS-45	474 4
	144200-048-12	48,3	28	Siehe MOD 5042	QS-45	474 4
V4A	316	Hochglanzpoliert				
OUTDOOR						
	144200-042-10	42,4	28	Siehe MOD 5042	QS-45	474 4
	144200-048-10	48,3	28	Siehe MOD 5042	QS-45	474 4
Zinkdruckguss						
INDOOR						
SELL OUT	104200-042-...	42,4	30	Siehe MOD 5042	QS-46	474 4
SELL OUT	104200-048-...	48,3	30	Siehe MOD 5042	QS-46	474 4



Internationaler Geschmacksmusterschutz

Q-INFO 304 316 MOD 4200 Oberflächen

10

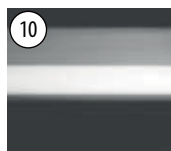

Hochglanzpoliert

12

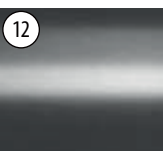

Gebürstet

82 RAL 9005



Schwarz, matt, strukturiert

Q-INFO

00



Artikel mit .00-Ausführung können pulverbeschichtet werden.

Q-INFO MOD 5015 / 4200

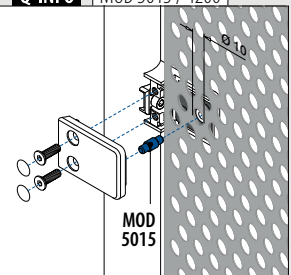

Q-INFO Zinkdruckguss MOD 4200 Oberflächen

00



Roh

17

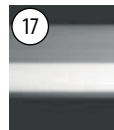

Glanzverchromt

19



Edelfstahleffekt

32 RAL 9016



Weiss, satiniert, glatt

33 RAL 7016



Anthrazitgrau, matt, strukturiert

36 RAL 9006



Weissaluminium, satiniert, glatt

82 RAL 9005



Schwarz, matt, strukturiert

89 RAL 9005



Schwarz, matt, glatt



104200-000-00

104200-000-17

104200-000-19

104200-000-32

104200-000-33

104200-000-36

104200-000-82

104200-000-89



104200-04x-00

104200-04x-19

104200-042-82

104200-042-89

Gummieinlagen für Blechadapter MOD 4200



2 Stück pro Blechadapter

MOD 5042

Zubehör		
	T	
205042-02	2	8
205042-03	3	8
205042-04	4	8

Sicherungsstifte

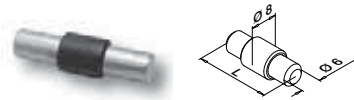

Optional verwendbar für MOD 4200

MOD 5015

Zubehör		
	L	
205015-22	22	4

Blechadapter - MOD 0743

Für flaches Rohr

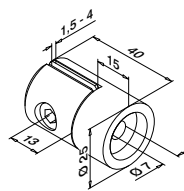

MOD 0743

V2A	304	Gebürstet		
INDOOR*				
130743-000		QS-17	472	4



Für rundes Rohr

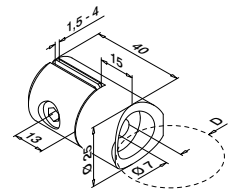

MOD 0743

V2A	304	Gebürstet		
INDOOR*		D		
130743-042		42,4	QS-17	472
130743-048		48,3	QS-17	472



* Auch für Aussenanwendung geeignet bei entsprechenden Bedingungen.



5

GLAS- BEFESTI- GUNGEN

Finden Sie Ihre Glasbefestigung 423 - 430

Glasklemmen 430 - 442

Glashalter 444 - 445

Glasverbinder 446 - 448

Scharniere und Türriegel 448 - 449

Glasadapter 451 - 453



GLAS- HALTER

▣ 444 - 445



Finden Sie alle
Informationen zu
Glasklemmen online:



[https://q-ne.ws/
GlassClamps23](https://q-ne.ws/GlassClamps23)

GLAS- KLEMMEN

▣ 430 - 442



GLAS- VERBINDER

▣ 446 - 448

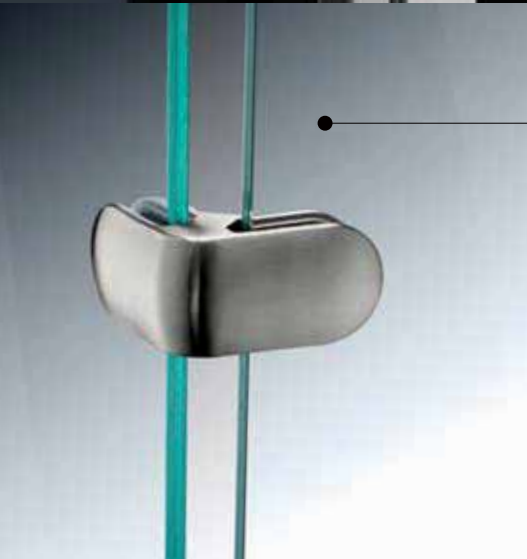

GLAS- ADAPTER

▣ 451 - 453



SCHARNIERE UND TÜRRIEGEL

▣ 448 - 449

GLASKLAR UND ABSOLUT SICHER

Glas wird oft als zerbrechliches Material angesehen, dabei ist es erstaunlich widerstandsfähig. Dies macht es zu einer hervorragenden Geländerfüllung. Kombinieren Sie es mit Q-railings starken Glashaltern und erhalten Sie ein äusserst robustes Geländer. Wir wissen das aus der Praxis: In unserem hauseigenen Prüflabor unterziehen wir unsere Produkte laufend strengen Tests. Ausserdem werden umfangreiche Prüfungen von zertifizierten unabhängigen Testinstituten und führenden Behörden durchgeführt.

Das Ergebnis: Unsere gemäss der internationalen Norm EN-12600 getesteten Glasklemmen halten dynamischen Belastungen von bis zu 50 kg stand – unabhängig davon, ob Sie gehärtetes Verbundglas oder monolithisches Glas (6 - 21,52 mm) wählen. Beide Varianten entsprechen den internationalen DIN- und BS-Normen und besitzen die allgemeine bauaufsichtliche Zulassung (AbZ).

ZERTIFIZIERUNG

Unsere Glasklemmen sind nach DIN/EN 12600 getestet und haben daneben eine AbZ.

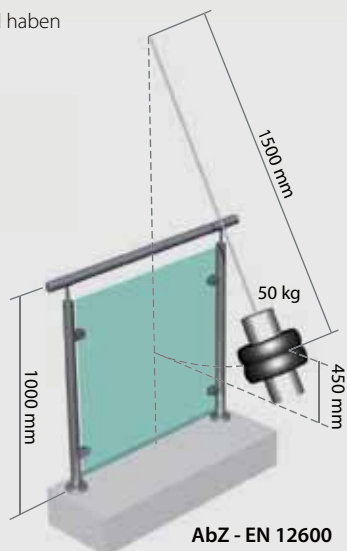
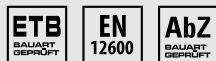

SICHERHEIT

Seitenmontage? Sicherheit geht vor!

Verwenden Sie Sicherungsstifte oder Sicherungsplatten.



(MOD 5015)



(Enthalten in MOD 2300, 2400, 2600, 4200)

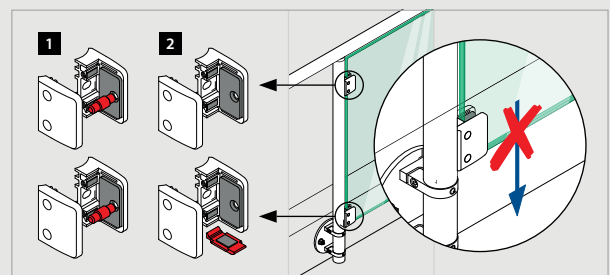

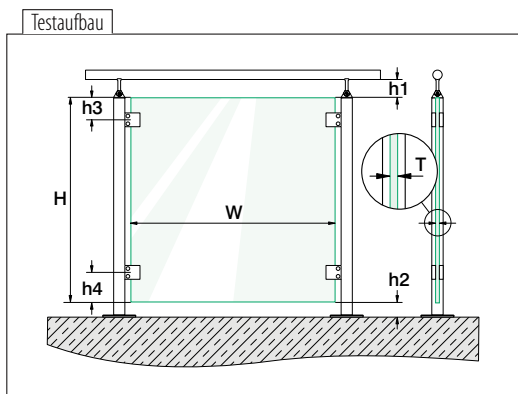

Abmessungen (mm)	min.	max.
W Glasbreite	500	Siehe entspr. Modell
T Glasstärke	Siehe entspr. Modell	Siehe entspr. Modell
H Glashöhe	800	1000
h1 Abstand Handlauf - Glas	10	50 ohne Kantenschutz / 120 mit Kantenschutz
h2 Abstand Boden - Glas	10	50 ohne Kantenschutz / 120 mit Kantenschutz
h3 Glaskante oben - Achse obere Glasklemme	100 : MOD 2500, 2100, 2600, 2400 50 : MOD 2800 120 : MOD 4200	150
h4 Glaskante unten - Achse untere Glasklemme	100 : MOD 2500, 2100, 2600, 2400 50 : MOD 2800 120 : MOD 4200	150

INDOOR

Glasklemmen ohne Sicherungsstift und ohne Sicherungsplatte.

MOD 2700

V2A 304 Zinkdruckguss



Flach oder Rohr
Ø 33,7 mm
Ø 42,4 mm

Glasart	Mono / ESG-H*		
T (mm)	8		
W _{max} (mm)	1200		

MOD 2500

V2A 304 Zinkdruckguss



Flach oder Rohr
Ø 42,4 mm
Ø 48,3 mm

Glasart	VSG / TVG*					VSG / ESG*					Mono / ESG-H*		
T (mm)	8,76	9,52	10,76	11,52	12,76	8,76	9,52	10,76	11,52	12,76	8	10	12
W _{max} (mm)	1500	1500	1500	1500	1500	1500	1500	1500	1500	1500	1500	1500	1500

MOD 2800

V2A 304 Zinkdruckguss



Flach oder Rohr
Ø 48,3 mm

Glasart	VSG / SPG*	VSG / TVG*					VSG / ESG*					Mono / ESG-H*		
T (mm)	12,76	8,76	9,52	10,76	11,52	12,76	8,76	9,52	10,76	11,52	12,76	8	10	12
W _{max} (mm)	1500	1800	1800	1800	1800	1800	1800	1800	1800	1800	2000	1800	1800	1800

MOD 2100

V2A 304 Zinkdruckguss



Flach oder Rohr
Ø 42,4 mm

Glasart	VSG / ESG*									
T (mm)	8,76					9,52				
W _{max} (mm)	1200					1200				

MOD 4200

V2A 304 Zinkdruckguss



Flach oder Rohr
Ø 42,4 mm
Ø 48,3 mm

Glasart	VSG / SPG*	VSG / TVG*				VSG / ESG*				Mono / ESG-H*		
T (mm)	12,76	10,76	11,52	12,76	8,76	9,52	10,76	11,52	12,76	8	10	12
W _{max} (mm)	1600	1600	1600	1600	1800	1800	1800	1800	1800 ¹ 2000 ²	1800	1800	1800

¹ Zinkdruckguss ² Edelstahl 304

MOD 2600

V2A 304



Flach oder Rohr
Ø 42,4 mm
Ø 48,3 mm

Glasart	VSG / TVG*				VSG / ESG*				Mono / ESG-H*		
T (mm)	8,76	10,76	11,52	12,76	8,76	10,76	11,52	12,76	8	10	12
W _{max} (mm)	1400	1600	1600	1600	1400	1600	1600	1600	1400	1600	1600

MOD 2400

V2A 304 Zinkdruckguss



Flach oder Rohr
Ø 48,3 mm

Glasart	VSG / SPG*				VSG / TVG*				VSG / ESG*				Mono / ESG-H*	
T (mm)	12,76	13,52	16,76	17,52	12,76	13,52	16,76	17,52	12,76	13,52	16,76	17,52	12	15
W _{max} (mm)	1500	1500	1500	1500	1500	1500	1500	1500	1600	1600	1600	1600	1600	1600



OUTDOOR

Mögliche Glasbreite für die Anwendung im Aussenbereich abhängig von Windlast, Glastype und Glasstärke - ohne Sicherungsstift und ohne Sicherungsplatte.

MOD 2500

V4A 316



Flach
oder Rohr
Ø 42,4 mm
Ø 48,3 mm

Wind- druck	Glasart T (mm)	VSG / TVG*		VSG / ESG*		Mono / ESG-H*	
		8,76	9,52	10,76	12,76	8	10
2,20 kN/m ²	W _{max} (mm)	-	-	-	-	800	800
1,60 kN/m ²		-	-	500	500	1000	1400
1,40 kN/m ²		-	-	500	500	1000	1400
1,04 kN/m ²		500	500	800	800	1400	1500
1,00 kN/m ²		500	500	1000	1000	1400	1500
0,64 kN/m ²		800	800	1200	1200	1500	1500

MOD 2800 / 4200

V4A 316



Flach
oder Rohr
Ø 42,4 mm
Ø 48,3 mm

Flach
oder Rohr
Ø 42,4 mm
Ø 48,3 mm

Wind- druck	Glasart T (mm)	VSG / SPG*			VSG / TVG*			VSG / ESG*				Mono / ESG-H*			
		12,76	8,76	9,52	10,76	11,52	12,76	8,76	9,52	10,76	11,52	12,76	8	10	12
2,20 kN/m ²	W _{max} (mm)	-	-	-	700	700	950	650	650	950	950	1100	1000	1500	1700
2,00 kN/m ²		-	-	-	700	700	1000	700	700	1000	1000	1200	1050	1600	1800
1,60 kN/m ²		-	-	-	800	800	1100	800	800	1100	1100	1200	1200	1600	1800
1,40 kN/m ²		-	600	600	900	900	1300	850	850	1200	1200	1400	1250	1600	1800
1,04 kN/m ²		-	700	700	1050	1050	1300	1000	1000	1300	1300	1400	1500	1700	1800
1,00 kN/m ²		-	700	700	1050	1050	1300	1000	1000	1300	1300	1400	1500	1700	1800
0,70 kN/m ²		-	900	900	1050	1050	1400	1100	1100	1400	1400	1500	1550	1700	1800

MOD 2600

V4A 316



Flach
oder Rohr
Ø 42,4 mm
Ø 48,3 mm

Wind- druck	Glasart T (mm)	VSG / TVG*				VSG / ESG*				Mono / ESG-H*		
		8,76	10,76	11,52	12,76	8,76	10,76	11,52	12,76	8	10	12
2,20 kN/m ²	W _{max} (mm)	-	-	-	500	500	800	800	800	800	1000	1400
1,60 kN/m ²		-	500	500	800	800	800	800	1000	1000	1400	1400
1,40 kN/m ²		-	800	800	800	800	1000	1000	1200	1200	1400	1400
1,04 kN/m ²		500	800	800	1000	800	1000	1000	1400	1400	1400	1400
1,00 kN/m ²		500	800	800	1000	800	1200	1200	1400	1400	1400	1400
0,64 kN/m ²		800	1000	1000	1200	1200	1400	1400	1400	1400	1400	1400

MOD 2400

V4A 316



Flach
oder Rohr
Ø 48,3 mm

Wind- druck	Glasart T (mm)	VSG / SPG*				VSG / TVG*				VSG / ESG*				Mono / ESG-H*	
		12,76	13,52	16,76	17,52	12,76	13,52	16,76	17,52	12,76	13,52	16,76	17,52	12	16
2,20 kN/m ²	W _{max} (mm)	500	500	800	800	500	500	1000	1000	500	500	1000	1000	1400	1600
1,60 kN/m ²		500	500	1000	1000	800	800	1200	1200	800	800	1200	1200	1500	1600
1,40 kN/m ²		800	800	1000	1000	800	800	1200	1200	800	800	1400	1400	1600	1600
1,04 kN/m ²		800	800	1200	1200	1000	1000	1500	1500	1200	1200	1600	1600	1600	1600
1,00 kN/m ²		1000	1000	1200	1200	1000	1000	1500	1500	1200	1200	1600	1600	1600	1600
0,64 kN/m ²		1200	1200	1500	1500	1500	1500	1500	1500	1500	1500	1600	1600	1600	1600

* VSG: Verbundsicherheitsglas
Mono: Monolithisches Glas

SPG: Spiegelglas
TVG: Teilvorgespanntes Glas

ESG: Einscheibensicherheitsglas
ESG-H: Einscheibensicherheitsglas - Heisslagerungstest

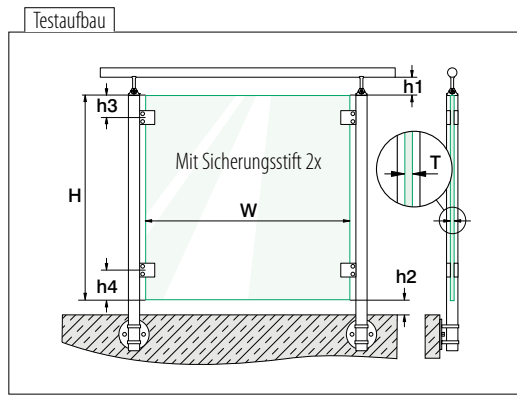

Abmessungen (mm)	min.	max.
W Glasbreite	500	Siehe entspr. Modell
T Glasstärke	Siehe entspr. Modell	Siehe entspr. Modell
H Glashöhe	800	1000
h1 Abstand Handlauf - Glas	10	50 ohne Kantenschutz / 120 mit Kantenschutz
h2 Abstand Boden - Glas	10	50 ohne Kantenschutz / 120 mit Kantenschutz
h3 Glaskante oben - Achse obere Glasklemme	150 : MOD 2500 / MOD 2400 50 : MOD 2800 120 : MOD 4200	150
h4 Glaskante unten - Achse untere Glasklemme	150 : MOD 2500 / MOD 2400 50 : MOD 2800 120 : MOD 4200	150

INDOOR



Glasklemmen mit Sicherungsstift, ohne Sicherungsplatte.

MOD 2500

V2A 304 Zinkdruckguss



Flach oder Rohr
Ø 42,4 mm
Ø 48,3 mm

Glasart	VSG / ESG*
T (mm)	12,76
W _{max} (mm)	1600

MOD 2800

V2A 304 Zinkdruckguss



Flach oder Rohr
Ø 42,4 mm
Ø 48,3 mm

Glasart	VSG / TVG*					VSG / ESG*					Mono / ESG-H*		
T (mm)	8,76	9,52	10,76	11,52	12,76	8,76	9,52	10,76	11,52	12,76	8	10	12
W _{max} (mm)	1800	1800	1800	1800	1800	1800	1800	1800	1800	1800	1800	1800	1800

MOD 4200

V2A 304 Zinkdruckguss



Flach oder Rohr
Ø 42,4 mm
Ø 48,3 mm

Glasart	VSG / SPG*	VSG / TVG*				VSG / ESG*					Mono / ESG-H*		
T (mm)	12,76	10,76	11,52	12,76	8,76	9,52	10,76	11,52	12,76	8	10	12	
W _{max} (mm)	1500	1600	1600	1600	1800	1800	1800	1800	1800 ¹ 2000 ²	1800	1800	1800	

¹ Zinkdruckguss ² Edelstahl 304

MOD 2400

V2A 304 Zinkdruckguss



Flach oder Rohr
Ø 42,4 mm
Ø 48,3 mm

Glasart	VSG / ESG*				Mono / ESG-H*	
T (mm)	12,76	13,52	16,76	17,52	12	15
W _{max} (mm)	1600	1600	1600	1600	1600	1600

* VSG: Verbundsicherheitsglas
Mono: Monolithisches Glas

SPG: Spiegelglas
TVG: Teilvorgespanntes Glas

ESG: Einscheibensicherheitsglas
ESG-H: Einscheibensicherheitsglas - Heisslagerungstest



OUTDOOR



Mögliche Glasbreite für die Anwendung im Aussenbereich abhängig von Windlast, Glastyp und Glasstärke - mit Sicherungsstift, ohne Sicherungsplatte.

MOD 2500

V4A 316



Flach
oder Rohr
Ø 42,4 mm
Ø 48,3 mm

Wind- druck	Glasart	VSG / ESG*	
	T (mm)	12,76	
2,20 kN/m ²	W _{max} (mm)	1100	
2,00 kN/m ²		1200	
1,60 kN/m ²		1200	
1,40 kN/m ²		1400	
1,04 kN/m ²		1400	
1,00 kN/m ²		1400	
0,70 kN/m ²		1500	

MOD 2800 / 4200

V4A 316



Flach
oder Rohr
Ø 42,4 mm
Ø 48,3 mm



Flach
oder Rohr
Ø 42,4 mm
Ø 48,3 mm

Wind- druck	Glasart T (mm)	VSG / TVG*					VSG / ESG*					Mono / ESG-H*		
		8,76	9,52	10,76	11,52	12,76	8,76	9,52	10,76	11,52	12,76	8	10	12
2,20 kN/m ²	W _{max} (mm)	-	-	700	700	950	650	650	950	950	1100	1000	1500	1700
2,00 kN/m ²		-	-	700	700	1000	700	700	1000	1000	1200	1050	1600	1800
1,60 kN/m ²		-	-	800	800	1100	800	800	1100	1100	1200	1200	1600	1800
1,40 kN/m ²		600	600	900	900	1300	850	850	1200	1200	1400	1250	1600	1800
1,04 kN/m ²		700	700	1050	1050	1300	1000	1000	1300	1300	1400	1500	1700	1800
1,00 kN/m ²		700	700	1050	1050	1300	1000	1000	1300	1300	1400	1500	1700	1800
0,70 kN/m ²		900	900	1050	1050	1400	1100	1100	1400	1400	1500	1550	1700	1800

MOD 2400

V4A 316



Flach
oder Rohr
Ø 48,3 mm

Wind- druck	Glasart T (mm)	VSG / ESG*				Mono / ESG-H*	
		12,76	13,52	16,76	17,52	12	15
2,20 kN/m ²	W _{max} (mm)	500	500	1000	1000	1400	1600
1,60 kN/m ²		800	800	1200	1200	1500	1600
1,40 kN/m ²		800	800	1400	1400	1600	1600
1,04 kN/m ²		1200	1200	1600	1600	1600	1600
1,00 kN/m ²		1200	1200	1600	1600	1600	1600
0,64 kN/m ²		1500	1500	1600	1600	1600	1600

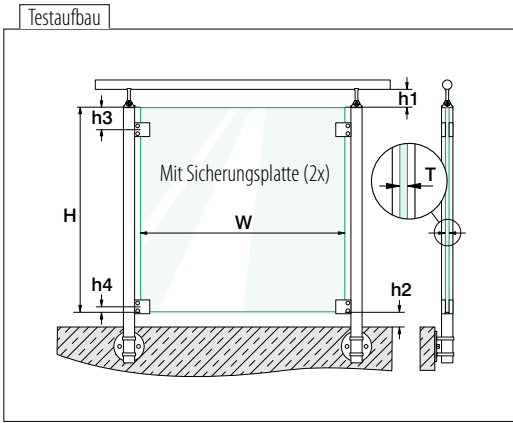

Abmessungen (mm)		min.	max.
W	Glasbreite	500	Siehe entspr. Modell
T	Glasstärke	Siehe entspr. Modell	Siehe entspr. Modell
H	Glashöhe	800	1000
h1	Abstand Handlauf - Glas	10	50 ohne Kantenschutz / 120 mit Kantenschutz
h2	Abstand Boden - Glas	10	50 ohne Kantenschutz / 120 mit Kantenschutz
h3	Glaskante oben - Achse obere Glasklemme	100 : MOD 2600, 2400 120 : MOD 4200	150
h4	Glaskante unten - Achse untere Glasklemme	29 : MOD 2400 22 : MOD 2600 16,5 : MOD 4200	29 : MOD 2400 22 : MOD 2600 16,5 : MOD 4200

INDOOR



Glasklemmen ohne Sicherungstift, mit Sicherungsplatte.

MOD 4200

V2A 304 Zinkdruckguss



Flach
oder Rohr
Ø 42,4 mm
Ø 48,3 mm

Glasart	VSG / SPG*		VSG / TVG*		VSG / ESG*				Mono / ESG-H*				
	T (mm)	12,76	10,76	11,52	12,76	8,76	9,52	10,76	11,52	12,76	8	10	12
W _{max} (mm)	1600	1600	1600	1600	1800	1800	1800	1800	1800	1800 ¹ 2000 ²	1800	1800	1800

¹ Zinkdruckguss ² Edelstahl 304

MOD 2600

V2A 304



Flach
oder Rohr
Ø 42,4 mm
Ø 48,3 mm

Glasart	VSG / ESG*				Mono / ESG-H*			
	T (mm)	8,76	10,76	11,52	12,76	8	10	12
W _{max} (mm)	1400	1400	1400	1400	1400	1400	1400	1400

MOD 2400

V2A 304 Zinkdruckguss



Flach
oder Rohr
Ø 48,3 mm

Glasart	VSG / TVG*				VSG / ESG*				Mono / ESG-H*		
	T (mm)	12,76	13,52	16,76	17,52	12,76	13,52	16,76	17,52	12	15
W _{max} (mm)	1500	1500	1500	1500	1600	1600	1600	1600	1600	1600	1600

* VSG: Verbundsicherheitsglas
Mono: Monolithisches Glas

SPG: Spiegelglas
TVG: Teilvorgespanntes Glas

ESG: Einscheibensicherheitsglas
ESG-H: Einscheibensicherheitsglas - Heisslagerungstest



OUTDOOR



Mögliche Glasbreite für die Anwendung im Aussenbereich abhängig von Windlast, Glastyp und Glasstärke - ohne Sicherungsstift, mit Sicherungsplatte.

MOD 4200

V4A 316



Flach oder Rohr
Ø 42,4 mm
Ø 48,3 mm

Wind-druck	Glasart T (mm)	VSG / TVG*					VSG / ESG*					Mono / ESG-H*		
		8,76	9,52	10,76	11,52	12,76	8,76	9,52	10,76	11,52	12,76	8	10	12
2,20 kN/m ²	W _{max} (mm)	-	-	700	700	1000	650	650	950	950	1100	1000	1500	1700
2,00 kN/m ²		-	-	750	750	1050	700	700	1000	1000	1300	1050	1600	1800
1,60 kN/m ²		-	-	850	850	1200	800	800	1100	1100	1300	1200	1600	1800
1,40 kN/m ²		600	600	950	950	1300	850	850	1200	1200	1500	1250	1600	1800
1,04 kN/m ²		700	700	1100	1100	1300	1000	1000	1400	1400	1500	1500	1700	1800
1,00 kN/m ²		700	700	1100	1100	1300	1000	1000	1400	1400	1500	1500	1700	1800
0,70 kN/m ²		900	900	1100	1100	1400	1050	1050	1500	1500	1600	1550	1700	1800

MOD 2600

V4A 316



Flach oder Rohr
Ø 42,4 mm
Ø 48,3 mm

Wind-druck	Glasart T (mm)	VSG / ESG*				Mono / ESG-H*		
		8,76	10,76	11,52	12,76	8	10	12
2,20 kN/m ²	W _{max} (mm)	500	800	800	800	800	1000	1400
1,60 kN/m ²		800	800	800	1000	1000	1400	1400
1,40 kN/m ²		800	1000	1000	1200	1200	1400	1400
1,04 kN/m ²		800	1000	1000	1400	1400	1400	1400
1,00 kN/m ²		800	1200	1200	1400	1400	1400	1400
0,64 kN/m ²		1200	1400	1400	1400	1400	1400	1400

MOD 2400

V4A 316



Flach oder Rohr
Ø 48,3 mm

Wind-druck	Glasart T (mm)	VSG / TVG*				VSG / ESG*				Mono / ESG-H*	
		12,76	13,52	16,76	17,52	12,76	13,52	16,76	17,52	12	15
2,20 kN/m ²	W _{max} (mm)	500	500	500	500	500	500	1000	1000	1400	1600
1,60 kN/m ²		500	500	800	800	800	800	1200	1200	1500	1600
1,40 kN/m ²		500	500	1000	1000	800	800	1400	1400	1600	1600
1,04 kN/m ²		800	800	1200	1200	1200	1200	1500	1500	1600	1600
1,00 kN/m ²		800	800	1200	1200	1200	1200	1500	1500	1600	1600
0,64 kN/m ²		1500	1500	1500	1500	1500	1500	1600	1600	1600	1600

GLASBEFESTIGUNGEN – GLASSTÄRKEN

	Monolithisches Glas						Laminiertes Glas														
		Glasstärke (mm)						Glasstärke (mm)													
		6	8	10	12	15	19	6,76	8,38	8,76	9,52	10,76	11,52	12,76	13,52	16,76	17,52	20,76	21,52	25,52	
Glasklemmen	MOD 2700	431	■	■	■			■		■		■									
	MOD 2500	432	■	■	■	■		■		■	■	■	■	■							
	MOD 2800	433	■	■	■	■				■	■	■	■	■							
	MOD 4200	434 - 435	■	■	■	■		■	■	■	■	■	■	■							
	MOD 2100	436	■	■	■			■		■	■										
	MOD 2600	437		■	■	■				■		■	■	■							
	MOD 2400	438				■	■				■		■	■	■	■	■				
	MOD 2300	439				■	■	■			■		■	■	■	■	■	■	■	■	
	MOD 4400/4600	440		■	■					■		■									
	MOD 5100/5200	441		■	■					■		■									
	MOD 2900	442		■	■	■				■		■		■	■						
Glashalter	MOD 5500	444		■	■	■				■		■	■	■	■						
	MOD 5501	445		■	■	■				■		■	■	■	■						
Glasverbinder	MOD 2870/2880/2890	446	■	■	■	■				■	■	■	■	■		■	■	■	■		
	MOD 4270/4280/4290	447	■	■	■	■		■	■	■	■	■	■	■		■	■	■	■	■	
	MOD 0742	448					■	■					■	■	■	■	■	■	■		
Scharniere und Türriegel	MOD 0283/0281	449	■	■	■	■		■	■	■	■	■	■	■							
	MOD 0284/0282	448	■	■	■	■		■	■	■	■	■	■	■							
Glasadapter	MOD 0754	451		■	■	■	■		■	■	■	■	■	■	■	■	■	■			
	MOD 0746	452	■	■	■	■	■	■	■	■	■	■	■	■	■	■	■	■			
	MOD 0740	452	■	■	■	■	■	■	■	■	■	■	■	■	■	■	■	■			
	MOD 0755	452	■	■	■	■		■	■	■	■	■	■	■							
	MOD 0747/1747	453		■	■	■	■		■	■	■	■	■	■	■	■	■	■	■	■	

Das Q-railing Sortiment bietet Halter für Glasfüllungen in verschiedenen Ausführungen an. Prüfen Sie die Optionen und die entsprechenden Artikelcodes für Produkte aus Zinkdruckguss, Edelstahl und Aluminium auf Seite 7.

Glasklemmen - MOD 2700

Für flaches Rohr

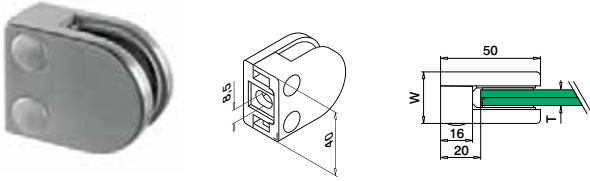

Für rundes Rohr

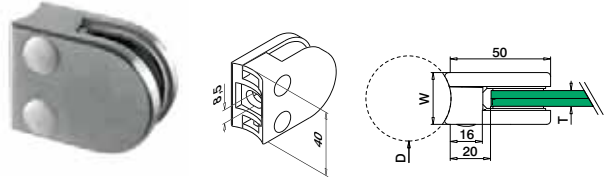

MOD 2700

V2A	304	Gebürstet			
INDOOR*		W	T		
132700-000-12	26	Siehe MOD 5027	QS-26		474 4

V4A	316	Gebürstet			
OUTDOOR		W	T		
142700-000-12	26	Siehe MOD 5027	QS-27		474 4

Zinkdruckguss					
INDOOR		W	T		
102700-000-...	28	Siehe MOD 5027	QS-28		474 4



MOD 2700

V2A	304	Gebürstet				
INDOOR*		D	W	T		
132700-033-12	33,7	26	Siehe MOD 5027	QS-47		474 4
132700-042-12	42,4	26	Siehe MOD 5027	QS-47		474 4

V4A	316	Gebürstet				
OUTDOOR		D	W	T		
142700-033-12	33,7	26	Siehe MOD 5027	QS-45		474 4
142700-042-12	42,4	26	Siehe MOD 5027	QS-45		474 4

Zinkdruckguss						
INDOOR		D	W	T		
102700-033-...	33,7	28	Siehe MOD 5027	QS-46		474 4
102700-042-...	42,4	28	Siehe MOD 5027	QS-46		474 4



Gummieinlagen für MOD 2700



2 Stück pro Glasklemme

MOD 5027

Zubehör		
Für monolithisches Glas	T	
205027-06	6	8
205027-08	8	8
205027-10	10	8

Für laminiertes Glas		
	T	
205027-07	6,76	8
205027-09	8,76	8
205027-11	10,76	8

* Auch für Aussenanwendung geeignet bei entsprechenden Bedingungen.

Nur solange der Vorrat reicht.

Bitte bestellen Sie Befestigungsmaterial separat.

Q-INFO



Artikel mit .00-Ausführung können pulverbeschichtet werden.

Q-INFO Zinkdruckguss MOD 2700 Oberflächen

	00	17	19
	Roh	Glanzverchromt	Edelstahleffekt
	102700-000-00	102700-000-17	102700-000-19
			102700-0xx-19

Q-INFO MOD 1062

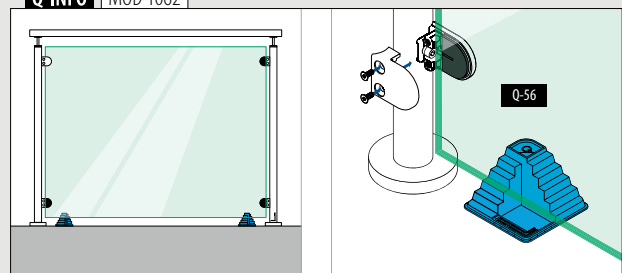

Glasklemmen - MOD 2500

Für flaches Rohr

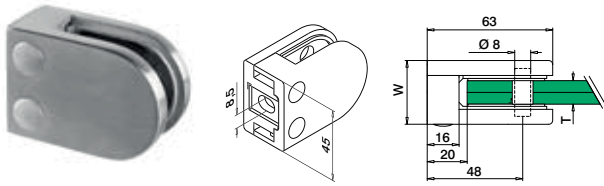

MOD 2500

V2A	304	Gebürstet	INDOOR*	W	T	QS-26	474	4
			132500-000-12	30	Siehe MOD 5025	QS-26	474	4
V4A	316	Gebürstet	OUTDOOR					
			142500-000-12	30	Siehe MOD 5025	QS-27	474	4
V4A	316	Hochglanzpoliert	OUTDOOR					
			142500-000-10	30	Siehe MOD 5025	QS-27	474	4
V4A	316	Black Line	OUTDOOR					
NEW			142500-000-82	30	Siehe MOD 5025	QS-27	474	4
		Zinkdruckguss	INDOOR					
SELL OUT			102500-000-...	32	Siehe MOD 5025	QS-28	474	4



Für rundes Rohr

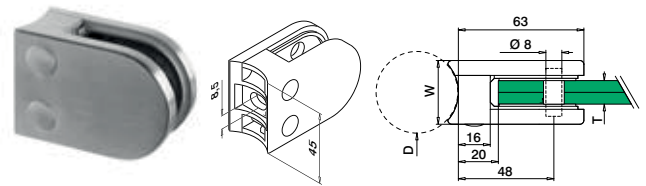

MOD 2500

V2A	304	Gebürstet	INDOOR*	D	W	T	QS-47	474	4
			132500-042-12	42,4	30	Siehe MOD 5025	QS-47	474	4
			132500-048-12	48,3	30	Siehe MOD 5025	QS-47	474	4
V4A	316	Gebürstet	OUTDOOR						
			142500-042-12	42,4	30	Siehe MOD 5025	QS-45	474	4
			142500-048-12	48,3	30	Siehe MOD 5025	QS-45	474	4
V4A	316	Hochglanzpoliert	OUTDOOR						
			142500-042-10	42,4	30	Siehe MOD 5025	QS-45	474	4
			142500-048-10	48,3	30	Siehe MOD 5025	QS-45	474	4
		Zinkdruckguss	INDOOR						
SELL OUT			102500-042-...	42,4	32	Siehe MOD 5025	QS-46	474	4
SELL OUT			102500-048-...	48,3	32	Siehe MOD 5025	QS-46	474	4



Gummieinlagen für MOD 2500



2 Stück pro Glasklemme

MOD 5025

Zubehör		
Für monolithisches Glas	T	
205025-06	6	8
205025-08	8	8
205025-10	10	8
205025-12	12	8
Für laminiertes Glas		
205025-07	6,76	8
205025-09	8,76	8
205025-44	9,52	8
205025-11	10,76	8
205025-54	11,52	8
205025-13	12,76	8

Sicherungsstifte

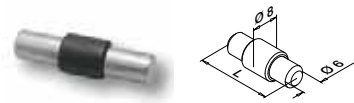

Optional verwendbar für MOD 2500

MOD 5015

Zubehör		
	L	
205015-25	25	4

SELL OUT Nur solange der Vorrat reicht.

* Auch für Aussenanwendung geeignet bei entsprechenden Bedingungen.

Q-INFO 316 MOD 2500 Oberflächen

10	12	82 RAL 9005
Hochglanzpoliert	Gebürstet	Pulverbeschichtet
		Schwarz, matt, strukturiert

Q-INFO Zinkdruckguss MOD 2500 Oberflächen

00	17	19	32 RAL 9016	82 RAL 9005	89 RAL 9005
Roh	Glanzverchromt	Edelstahleffekt	Pulverbeschichtet INDOOR	Pulverbeschichtet	Pulverbeschichtet INDOOR
			Weiss, satiniert, glatt	Schwarz, matt, strukturiert	Schwarz, matt, glatt
□	102500-000-00	102500-000-17	102500-000-19	102500-000-32	102500-000-89
○	102500-04x-00		102500-04x-19		

Q-INFO MOD 5015 / 2500

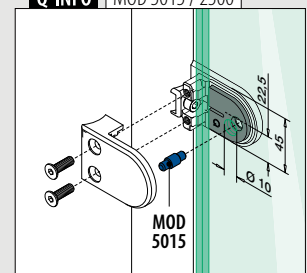

Glasklemmen - MOD 2800

Für flaches Rohr

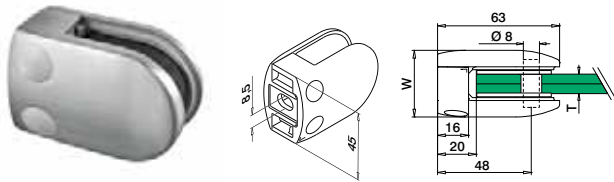

Für rundes Rohr

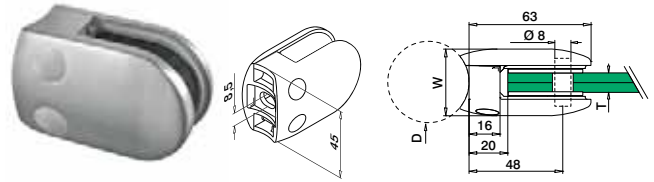

MOD 2800

V2A	304	Gebürstet				
INDOOR*		W	T			
132800-000-12	34	Siehe MOD 5028	QS-26		474	4
V2A	304	Hochglanzpoliert				
INDOOR*						
SELL OUT	132800-000-10	34	Siehe MOD 5028	QS-26		474 4
V4A	316	Gebürstet				
OUTDOOR						
142800-000-12	34	Siehe MOD 5028	QS-27		474	4
V4A	316	Hochglanzpoliert				
OUTDOOR						
142800-000-10	34	Siehe MOD 5028	QS-27		474	4
V4A	316	Black Line				
OUTDOOR						
NEW	142800-000-82	34	Siehe MOD 5028	QS-27		474 4
Zinkdruckguss						
INDOOR						
SELL OUT	102800-000-...	36	Siehe MOD 5028	QS-28		474 4



Internationaler Geschmacksmusterschutz

Gummieinlagen für MOD 2800



2 Stück pro Glasklemme

MOD 5028

Zubehör		
Für monolithisches Glas	T	
205028-06	6	8
205028-08	8	8
205028-10	10	8
205028-12	12	8
Für laminiertes Glas		
205028-09	8,76	8
205028-44	9,52	8
205028-11	10,76	8
205028-54	11,52	8
205028-13	12,76	8

MOD 2800

V2A	304	Gebürstet					
INDOOR*		D	W	T			
132800-042-12	42,4	34	Siehe MOD 5028	QS-47		474 4	
132800-048-12	48,3	34	Siehe MOD 5028	QS-47		474 4	
V2A	304	Hochglanzpoliert					
INDOOR*							
SELL OUT	132800-042-10	42,4	34	Siehe MOD 5028	QS-47		474 4
SELL OUT	132800-048-10	48,3	34	Siehe MOD 5028	QS-47		474 4
V4A	316	Gebürstet					
OUTDOOR							
142800-042-12	42,4	34	Siehe MOD 5028	QS-45		474 4	
142800-048-12	48,3	34	Siehe MOD 5028	QS-45		474 4	
V4A	316	Hochglanzpoliert					
OUTDOOR							
142800-042-10	42,4	34	Siehe MOD 5028	QS-45		474 4	
NEW	142800-048-10	42,4	34	Siehe MOD 5028	QS-45		474 4
Zinkdruckguss							
INDOOR							
SELL OUT	102800-042-...	42,4	36	Siehe MOD 5028	QS-46		474 4
SELL OUT	102800-048-...	48,3	36	Siehe MOD 5028	QS-46		474 4



Internationaler Geschmacksmusterschutz

Zubehör

Sicherungsstifte

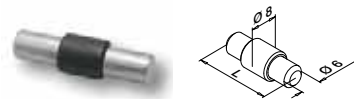

Optional verwendbar für MOD 2800

MOD 5015

Zubehör		
	L	
205015-22	22	4

Q-INFO | 304 | 316 | MOD 2800 | Oberflächen

10 	12 	82 RAL 9005 Pulverbeschichtet
Hochglanzpoliert	Gebürstet	Schwarz, matt, strukturiert

Q-INFO | Zinkdruckguss | MOD 2800 | Oberflächen

00 	17 	19 	82 RAL 9005 Pulverbeschichtet	89 RAL 9005 Pulverbeschichtet INDOOR
Roh	Glanzverchromt	Edelstahleffekt	Schwarz, matt, strukturiert	Schwarz, matt, glatt
	102800-000-00	102800-000-17	102800-000-19	102800-000-82
	102800-04x-00	102800-04x-19	102800-04x-82	102800-04x-89

Q-INFO | MOD 5015 / 2800

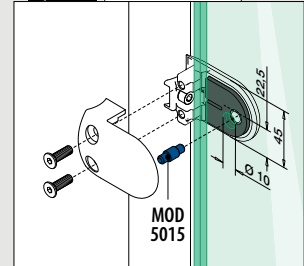

Glasklemmen - MOD 4200

Für flaches Rohr

Inklusive Sicherungsplatte

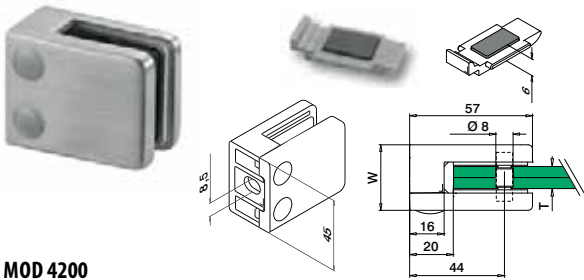

Für rundes Rohr

Inklusive Sicherungsplatte

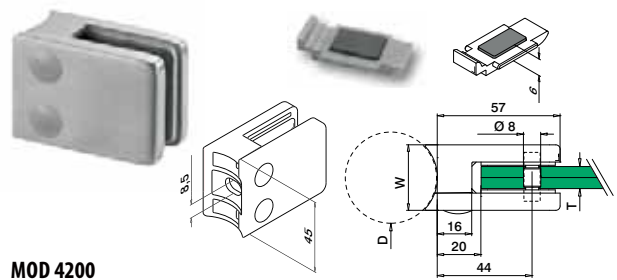

MOD 4200

V2A	304	Gebürstet				
INDOOR*		W	T			
	134200-000-12	28	Siehe MOD 5042	QS-26	474	4
V4A	316	Gebürstet				
OUTDOOR						
	144200-000-12	28	Siehe MOD 5042	QS-27	474	4
V4A	316	Hochglanzpoliert				
OUTDOOR						
	144200-000-10	28	Siehe MOD 5042	QS-27	474	4
V4A	316	Black Line				
OUTDOOR						
NEW	144200-000-82	28	Siehe MOD 5042	QS-27	474	4
Zinkdruckguss						
INDOOR						
SELL OUT	104200-000-...	30	Siehe MOD 5042	QS-28	474	4



Internationaler Geschmacksmusterschutz

MOD 4200

V2A	304	Gebürstet				
INDOOR*		D	W	T		
	134200-042-12	42,4	28	Siehe MOD 5042	QS-47	474 4
	134200-048-12	48,3	28	Siehe MOD 5042	QS-47	474 4
V2A	304	Black Line				
INDOOR*						
NEW	134200-042-82	42,4	28	Siehe MOD 5042	QS-47	474 4
V4A	316	Gebürstet				
OUTDOOR						
	144200-042-12	42,4	28	Siehe MOD 5042	QS-45	474 4
	144200-048-12	48,3	28	Siehe MOD 5042	QS-45	474 4
V4A	316	Hochglanzpoliert				
OUTDOOR						
	144200-042-10	42,4	28	Siehe MOD 5042	QS-45	474 4
	144200-048-10	48,3	28	Siehe MOD 5042	QS-45	474 4
Zinkdruckguss						
INDOOR						
SELL OUT	104200-042-...	42,4	30	Siehe MOD 5042	QS-46	474 4
SELL OUT	104200-048-...	48,3	30	Siehe MOD 5042	QS-46	474 4



Internationaler Geschmacksmusterschutz

Q-INFO 304 316 MOD 4200 Oberflächen

10

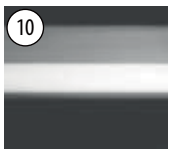

Hochglanzpoliert

12

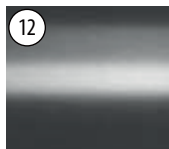

Gebürstet

82 RAL 9005



Schwarz, matt, strukturiert

Q-INFO

00



Artikel mit .00-Ausführung können pulverbeschichtet werden.



Q-INFO



MOD 4200 ist auch als Blechadapter erhältlich

Q-INFO Zinkdruckguss MOD 4200 Oberflächen

00



Roh

17

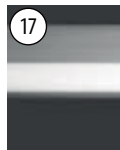

Glanzverchromt

19

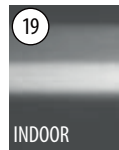

Edelstahleffekt

32 RAL 9016



Weiss, satiniert, glatt

33 RAL 7016



Anthrazitgrau, matt, strukturiert

36 RAL 9006



Weissaluminium, satiniert, glatt

82 RAL 9005



Schwarz, matt, strukturiert

89 RAL 9005



Schwarz, matt, glatt



104200-000-00

104200-000-17

104200-000-19

104200-000-32

104200-000-33

104200-000-36

104200-000-82

104200-000-89



104200-04x-00

104200-04x-19

104200-042-82

104200-042-89

Glasklemmen - MOD 4200

Für flaches Rohr

Inklusive Sicherungsplatte

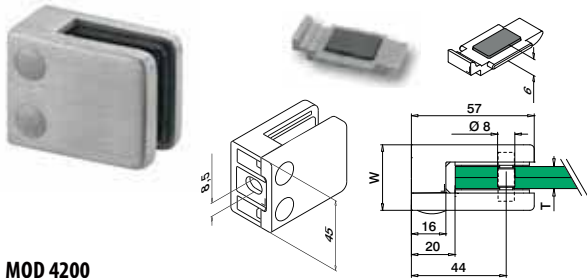

MOD 4200

Aluminium

INDOOR	W	T		
164200-000-...	30	Siehe MOD 5042	QS-26	474 4



Für rundes Rohr

Inklusive Sicherungsplatte

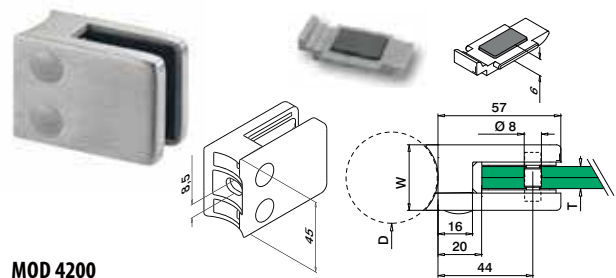

MOD 4200

Aluminium

INDOOR	D	W	T		
164200-042-...	42,4	30	Siehe MOD 5042	QS-47	474 4
164200-048-...	48,3	30	Siehe MOD 5042	QS-47	474 4



Gummieinlagen für MOD 4200



2 Stück pro Glasklemme

MOD 5042

Zubehör

Für monolithisches Glas	T	
205042-06	6	8
205042-08	8	8
205042-10	10	8
205042-12	12	8

Für laminiertes Glas

205042-07	6,76	8
205042-41	8,38	8
205042-09	8,76	8
205042-44	9,52	8
205042-11	10,76	8
205042-54	11,52	8
205042-13	12,76	8

Sicherungsstifte

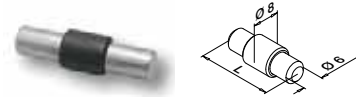

Optional verwendbar für MOD 4200

MOD 5015

Zubehör

	L	
205015-22	22	4

* Auch für Aussenanwendung geeignet bei entsprechenden Bedingungen.

Q-INFO

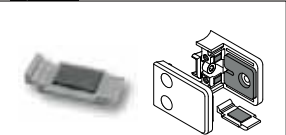

Verwenden Sie die Sicherungsplatte anstelle des Sicherungsstiftes. Das spart Ihnen Zeit und Kosten, weil Löcher im Glas nicht notwendig sind.

Q-INFO Aluminium MOD 4200 Oberflächen

00	32 RAL 9016	33 RAL 7016	36 RAL 9006	82 RAL 9005	89 RAL 9005
Roh	Pulverbeschichtet INDOOR Weiss, satiniert, glatt	Anthrazitgrau, matt, glatt	Weissaluminium, satiniert, glatt	Pulverbeschichtet Schwarz, matt, strukturiert	Pulverbeschichtet INDOOR Schwarz, matt, glatt
□	164200-000-00	164200-000-32	164200-000-33	164200-000-36	164200-000-82
○	164200-04x-00			164200-04x-82	

Q-INFO MOD 5015 / 4200

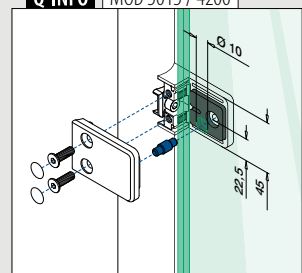

Glasklemmen - MOD 2100

Für flaches Rohr

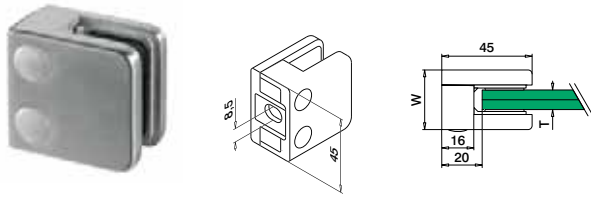

MOD 2100

V2A	304	Gebürstet					
INDOOR*		W	T				
	132100-000-12	27	Siehe MOD 5021	QS-26	474	4	
V2A	304	Black Line					
INDOOR*							
NEW	132100-000-82	27	Siehe MOD 5021	QS-26	474	4	
V4A	316	Gebürstet					
OUTDOOR							
	142100-000-12	27	Siehe MOD 5021	QS-27	474	4	



MOD 2100 getestet für INDOOR, 8 mm

MOD 2100

Zinkdruckguss

INDOOR		W	T			
SELL OUT	102100-000-...	29	Siehe MOD 5021	QS-28	474	4



Für rundes Rohr

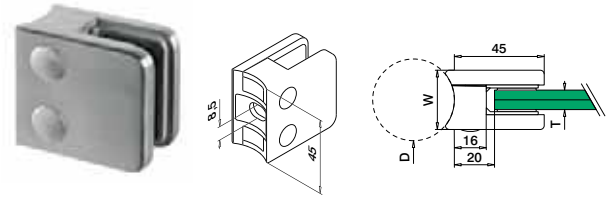

MOD 2100

V2A	304	Gebürstet					
INDOOR*		D	W	T			
	132100-042-12	42,4	27	Siehe MOD 5021	QS-47	474	4
V4A	316	Gebürstet					
OUTDOOR							
	142100-042-12	42,4	27	Siehe MOD 5021	QS-45	474	4



MOD 2100 getestet für INDOOR, 8 mm

MOD 2100

Zinkdruckguss

INDOOR		D	W	T			
SELL OUT	102100-042-...	42,4	29	Siehe MOD 5021	QS-46	474	4



Gummieinlagen für MOD 2100



2 Stück pro Glasklemme

MOD 5021

Zubehör

Für monolithisches Glas		T	
	205021-06	6	8
	205021-08	8	8
	205021-10	10	8
Für laminiertes Glas			
	205021-07	6,76	8
	205021-09	8,76	8
	205021-44	9,52	8

Q-INFO 304 316 Oberflächen

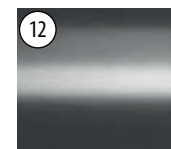

12 Gebürstet



82 RAL 9005 Pulverbeschichtet

Q-INFO Zinkdruckguss MOD 2100 Oberflächen



00 Roh



17 Glanzverchromt

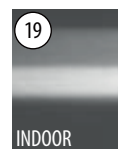

19 Edeltahleffekt INDOOR



32 RAL 9016 Weiss, satiniert, glatt



82 RAL 9005 Schwarz, matt, strukturiert



89 RAL 9005 Schwarz, matt, glatt

□	102100-000-00	102100-000-17	102100-000-19	102100-000-32	102100-000-82	102100-000-89
○	102100-042-00		102100-042-19			

Q-INFO



00 Artikel mit .00-Ausführung können pulverbeschichtet werden.



Glasklemmen - MOD 2600

Für flaches Rohr

Inklusive Sicherungsplatte

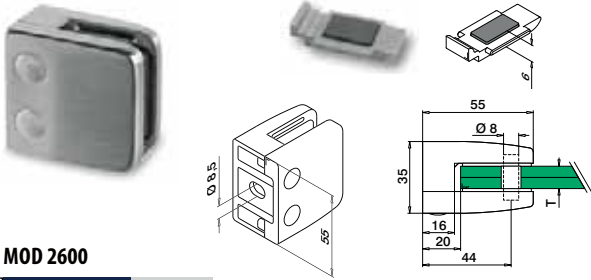

MOD 2600

V2A	304	Gebürstet
-----	-----	-----------

INDOOR*		T		
SELL OUT	132600-000-12	Siehe MOD 5026	QS-26	4

V4A	316	Gebürstet
-----	-----	-----------

OUTDOOR				
SELL OUT	142600-000-12	Siehe MOD 5026	QS-27	4



Für rundes Rohr

Inklusive Sicherungsplatte

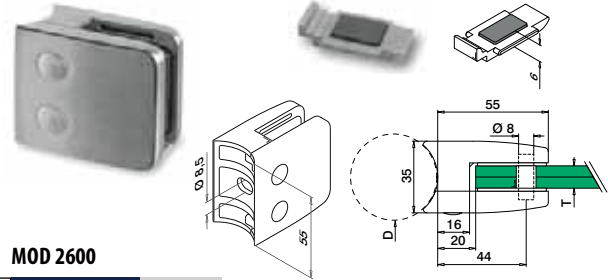

MOD 2600

V2A	304	Gebürstet
-----	-----	-----------

INDOOR*		D	T		
SELL OUT	132600-042-12*	42,4	Siehe MOD 5026	QS-47	4
SELL OUT	132600-048-12	48,3	Siehe MOD 5026	QS-47	4

V4A	316	Gebürstet
-----	-----	-----------

OUTDOOR					
SELL OUT	142600-042-12*	42,4	Siehe MOD 5026	QS-45	4
SELL OUT	142600-048-12	48,3	Siehe MOD 5026	QS-45	4
SELL OUT	142600-060-12	60,3	Siehe MOD 5026	QS-45	4



Gummieinlagen für MOD 2600



2 Stück pro Glasklemme

MOD 5026

Zubehör

Für monolithisches Glas		
SELL OUT	205026-08	8
SELL OUT	205026-10	8
SELL OUT	205026-12	8

Für laminiertes Glas		
SELL OUT	205026-09	8,76
SELL OUT	205026-11	10,76
SELL OUT	205026-54	11,52
SELL OUT	205026-13	12,76

Zubehör

Sicherungsstifte

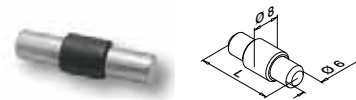

Optional verwendbar für MOD 2600

MOD 5015

Zubehör

	L	
205015-25	25	4

* Auch für Aussenanwendung geeignet bei entsprechenden Bedingungen.

Nur solange der Vorrat reicht.

Bitte bestellen Sie Befestigungsmaterial separat.

Q-INFO MOD 5015 / 2600

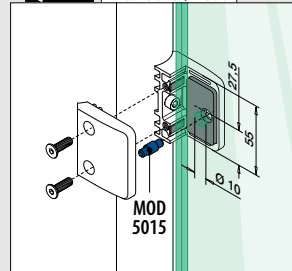

Q-INFO



Q-INFO MOD 2600

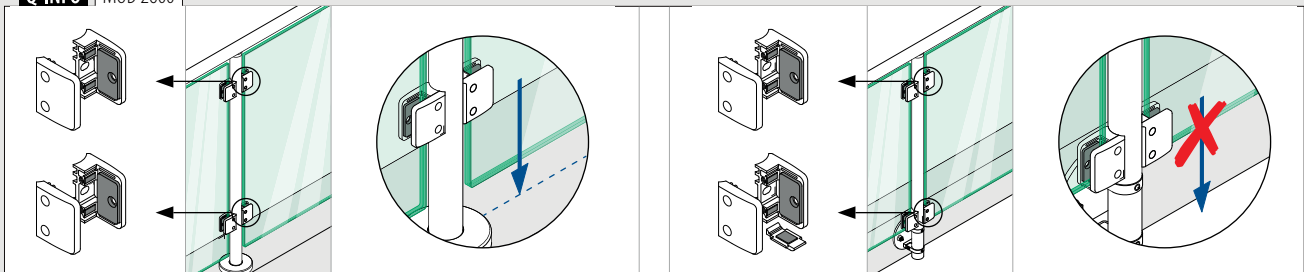

Glasklemmen - MOD 2400

Für flaches Rohr

Inklusive Sicherungsplatte

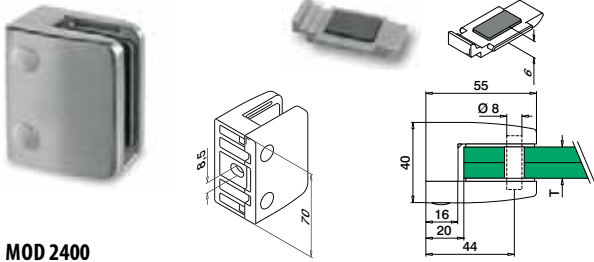

MOD 2400

V2A	304	Gebürstet		
INDOOR*				
SELL OUT	132400-000-12	Siehe T in MOD 5024	QS-26	474 4
V2A	304	Hochglanzpoliert		
INDOOR*				
SELL OUT	132400-000-10	Siehe T in MOD 5024	QS-26	474 4
V4A	316	Gebürstet		
OUTDOOR				
SELL OUT	142400-000-12	Siehe T in MOD 5024	QS-27	474 4
V4A	316	Hochglanzpoliert		
OUTDOOR				
SELL OUT	142400-000-10	Siehe T in MOD 5024	QS-27	474 4
Zinkdruckguss				
INDOOR				
SELL OUT	102400-000-...	Siehe T in MOD 5024	QS-28	474 4



Gummieinlagen für MOD 2400



2 Stück pro Glasklemme

MOD 5024

Zubehör

Für monolithisches Glas		
SELL OUT		
205024-12	12	8
205024-15	15	8
Für laminiertes Glas		
205024-44	9,52	8
205024-54	11,52	8
205024-13	12,76	8
205024-64	13,52	8
205024-17	16,76	8
205024-18	17,52	8

Q-INFO Zinkdruckguss Oberflächen

	00	19
	Roh	Edelstahleffekt
□	102400-000-00	102400-000-19
○	102400-048-00	

Für rundes Rohr

Inklusive Sicherungsplatte

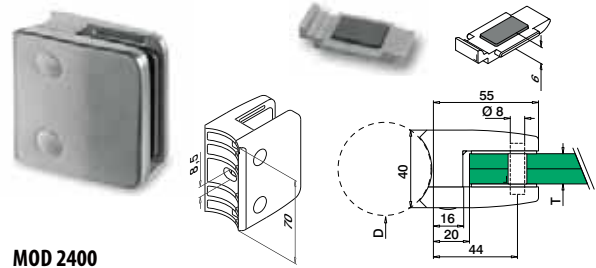

MOD 2400

V2A	304	Gebürstet		
INDOOR*				
SELL OUT	132400-048-12	48,3	Siehe T in MOD 5024	QS-47 474 4
V4A	316	Gebürstet		
OUTDOOR				
SELL OUT	142400-048-12	48,3	Siehe T in MOD 5024	QS-45 474 4
Zinkdruckguss				
INDOOR				
SELL OUT	102400-048-...	48,3	Siehe T in MOD 5024	QS-46 474 4



Zubehör

Sicherungsstifte

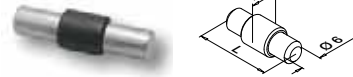

Optional verwendbar für MOD 2400

MOD 5015

Zubehör

	L	
205015-24	30	4

* Auch für Aussenanwendung geeignet bei entsprechenden Bedingungen.

SELL OUT Nur solange der Vorrat reicht.

Q-INFO MOD 5015 / 2400

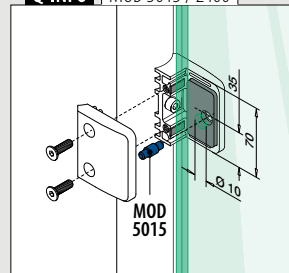

Q-INFO



Q-INFO 304 316



Q-INFO



Glasklemmen - MOD 2300

Für flaches Rohr + Wandmontage

Inklusive Sicherungsplatte

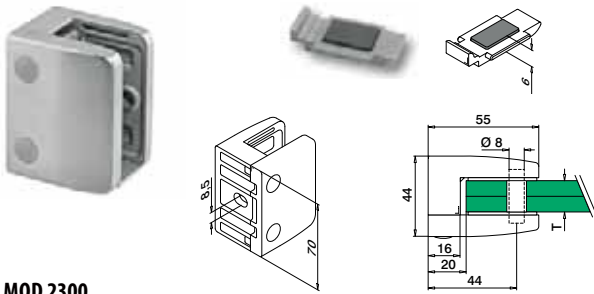

MOD 2300

V2A	304	Gebürstet	T		
INDOOR*					
NEW	132300-000-12		Siehe T in MOD 5023	QS-26	474 4
V4A	316	Gebürstet			
OUTDOOR					
	142300-000-12		Siehe T in MOD 5023	QS-27	474 4



Für rundes Rohr

Inklusive Sicherungsplatte

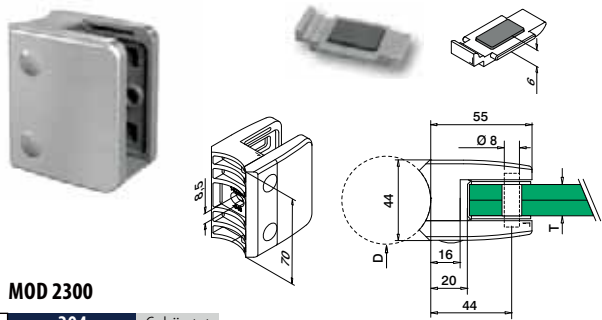

MOD 2300

V2A	304	Gebürstet	D	T		
INDOOR*						
	132300-048-12		48,3	Siehe T in MOD 5023	QS-47	474 4
V4A	316	Gebürstet				
OUTDOOR						
	142300-048-12		48,3	Siehe T in MOD 5023	QS-45	474 4

NEW

Gummieinlagen für MOD 2300



2 Stück pro Glasklemme

MOD 5023

Zubehör

Für monolithisches Glas	T	
NEW 205023-12	12	8
NEW 205023-15	15	8
205023-19	19	8

Für laminiertes Glas

NEW 205023-44	9,52	8
NEW 205023-54	11,52	8
NEW 205023-13	12,76	8
NEW 205023-64	13,52	8
NEW 205023-17	16,76	8
NEW 205023-18	17,52	8
205023-21	20,76	8
205023-22	21,52	8

Bitte bestellen Sie Befestigungsmaterial separat.

Q-INFO

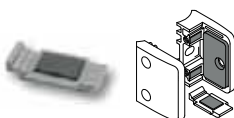

Verwenden Sie die Sicherungsplatte anstelle des Sicherungsstiftes. Das spart Ihnen Zeit und Kosten, weil Löcher im Glas nicht notwendig sind.

Q-INFO MOD 5015 / 2300

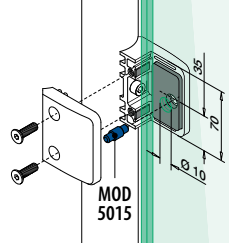

Sicherungsstifte

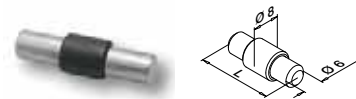

Optional verwendbar für MOD 2300

MOD 5015

Zubehör

	L	
205015-23	34	4

MOD 4901

304



Q-INFO MOD 2300

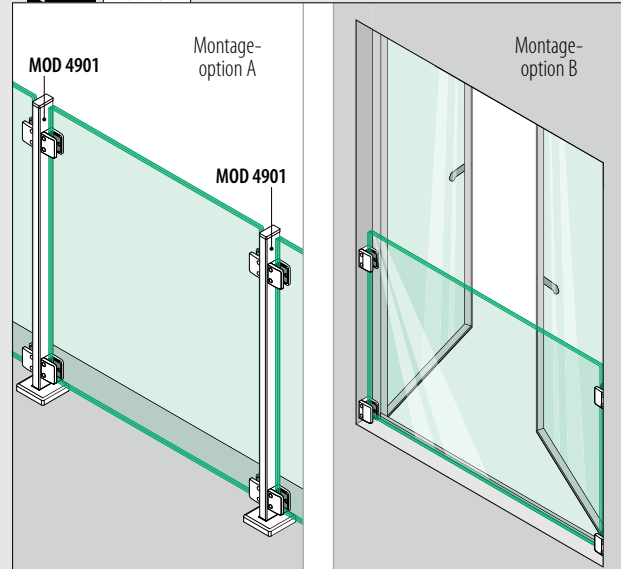

Glasklemmen - MOD 4400 / 4600

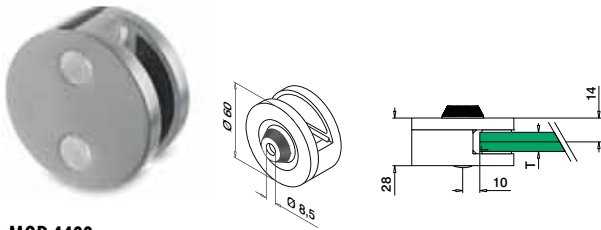

MOD 4400

V2A	304	Gebürstet		
INDOOR*		T		
134400-12	Siehe T in MOD 5044		QS-47	4
V4A	316	Gebürstet		
OUTDOOR				
144400-12	Siehe T in MOD 5044		QS-45	4
Zinkdruckguss		Edelstahleffekt		
OUTDOOR				
SELL OUT	104400-20	Siehe T in MOD 5044		QS-46

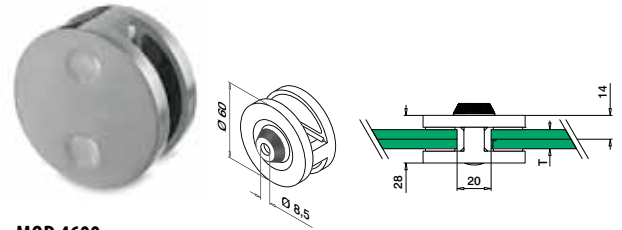

MOD 4600

V2A	304	Gebürstet		
INDOOR*		T		
134600-12	Siehe T in MOD 5044		QS-47	4
V4A	316	Gebürstet		
OUTDOOR				
144600-12	Siehe T in MOD 5044		QS-45	4
Zinkdruckguss		Edelstahleffekt		
OUTDOOR				
SELL OUT	104600-20	Siehe T in MOD 5044		QS-46



Adapter für MOD 4400 / 4600

Für flaches Rohr



MOD 0723

V2A	304	Gebürstet		
INDOOR*				
130723-000-12				4
V4A	316	Gebürstet		
OUTDOOR				
140723-000-12				4
Zinkdruckguss		Edelstahleffekt		
OUTDOOR				
SELL OUT	100723-000			4

Für rundes Rohr

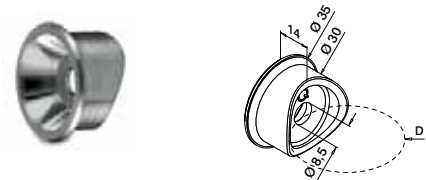

MOD 0723

V2A	304	Gebürstet		
INDOOR*		D		
130723-042-12	42,4			4
SELL OUT	130723-048-12	48,3		4
V4A	316	Gebürstet		
OUTDOOR				
140723-042-12	42,4			4
140723-048-12	48,3			4
Zinkdruckguss		Edelstahleffekt		
OUTDOOR				
SELL OUT	100723-042	42,4		4

Gummeinlagen für MOD 4400 / 4600



2 Stück für MOD 4400,
4 Stück für MOD 4600

MOD 5044

Zubehör		
Für monolithisches Glas T		
205044-08	8	8
205044-10	10	8
205044-12	12	8
Für laminiertes Glas		
205044-09	8,76	8
205044-11	10,76	8
205044-13	12,76	8

SELL OUT Nur solange der Vorrat reicht.

Q-INFO

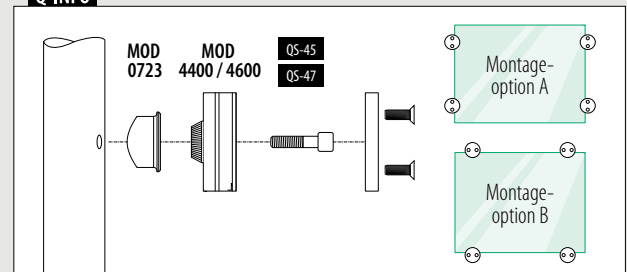

* Auch für Aussenanwendung geeignet bei entsprechenden Bedingungen.

Glasklemmen - MOD 5100 / 5200

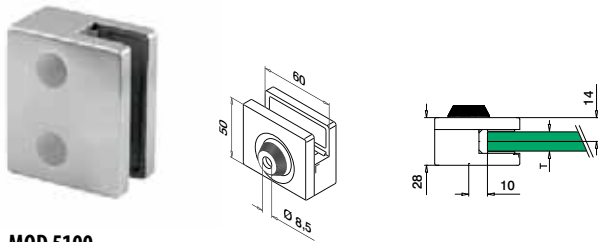

MOD 5100

V2A	304	Gebürstet			
INDOOR*		T			
135100-12	Siehe T in MOD 5051		QS-47	474	4
V4A	316	Gebürstet			
OUTDOOR					
145100-12	Siehe T in MOD 5051		QS-45	474	4

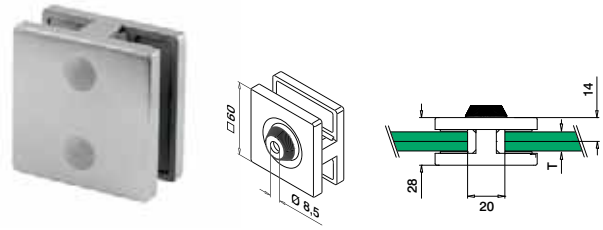

MOD 5200

V2A	304	Gebürstet			
INDOOR*		T			
135200-12	Siehe T in MOD 5051		QS-47	474	4
V4A	316	Gebürstet			
OUTDOOR					
145200-12	Siehe T in MOD 5051		QS-45	474	4



Adapter für MOD 5100 / 5200



MOD 0723

V2A	304	Gebürstet			
INDOOR*					
130723-000-12				4	
V4A	316	Gebürstet			
OUTDOOR					
140723-000-12				4	



MOD 0723

V2A	304	Gebürstet			
INDOOR*		D			
130723-042-12	42,4			4	
SELL OUT	130723-048-12	48,3		4	
V4A	316	Gebürstet			
OUTDOOR					
140723-042-12	42,4			4	
140723-048-12	48,3			4	

Gummieinlagen für MOD 5100 / 5200



MOD 5051

Zubehör		
Für monolithisches Glas		
205051-08	8	8
205051-10	10	8
Für laminiertes Glas		
205051-09	8,76	8
205051-11	10,76	8
205051-13	12,76	8

Q-INFO

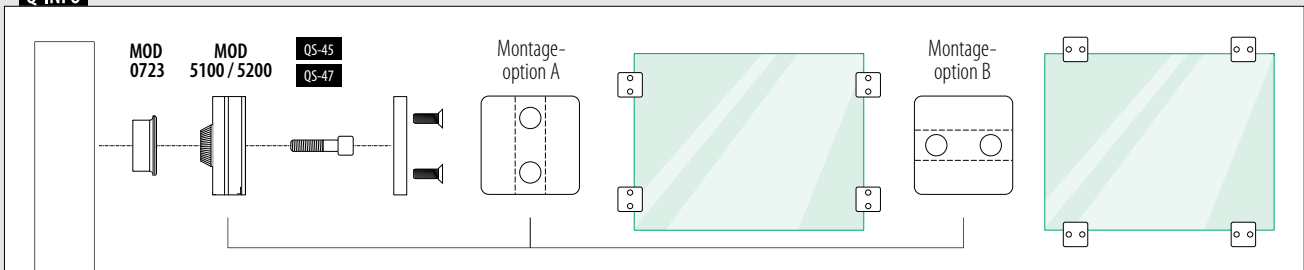

Glasklemmen - MOD 2900

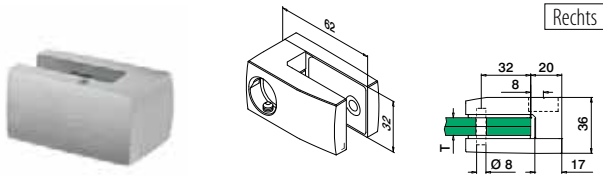

Rechts

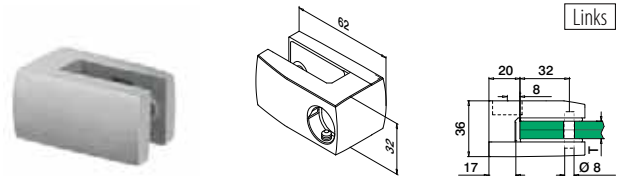

Links

MOD 2900

V4A	316	Gebürstet		
	OUTDOOR		T	
SELL OUT	142900-01-12		Siehe T in MOD 5029	2



Internationaler Geschmacksmusterschutz

MOD 2900

V4A	316	Gebürstet		
	OUTDOOR		T	
SELL OUT	142900-02-12		Siehe T in MOD 5029	2



Internationaler Geschmacksmusterschutz

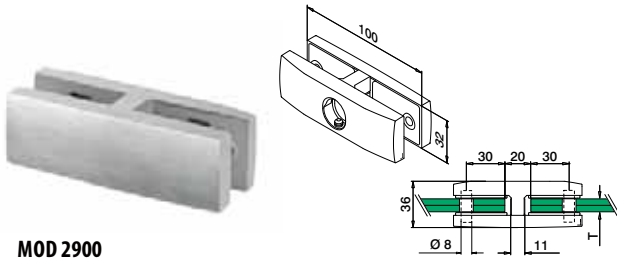

MOD 2900

V4A	316	Gebürstet		
	OUTDOOR		T	
SELL OUT	142900-00-12		Siehe T in MOD 5029	2



Internationaler Geschmacksmusterschutz

Zubehör

Sicherungsstifte

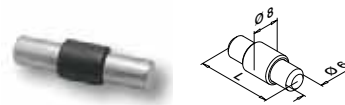

Optional verwendbar für MOD 2900

MOD 5015

	Zubehör			
		L		
205015-22		22		4

Adapter für MOD 2900

Für flaches Rohr



MOD 0785

V4A	316	Gebürstet		
	OUTDOOR			
140785-000-12		QS-16 ■ 472		4



Für rundes Rohr

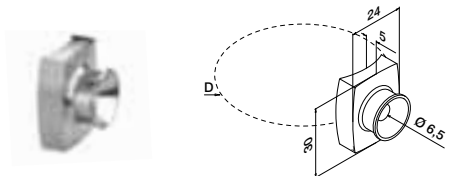

MOD 0785

V4A	316	Gebürstet		
	OUTDOOR		D	
140785-042-12		42,4		QS-16 ■ 472
140785-048-12		48,3		QS-16 ■ 472



Q-INFO MOD 0785

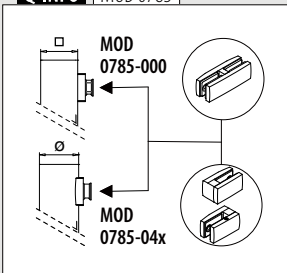

Bitte bestellen Sie Befestigungsmaterial separat.

Nur solange der Vorrat reicht.

Q-INFO MOD 2900

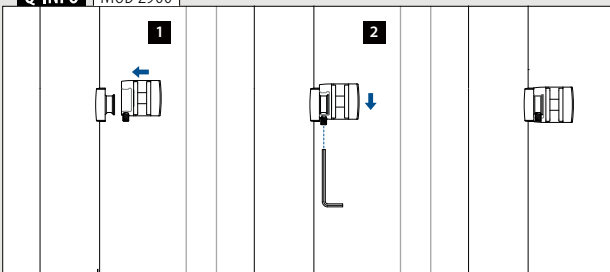

Füllungen

Gummieinlagen für MOD 2900



2 Stück pro Glasklemme,
4 Stück für MOD 142900-00-12

MOD 5029

	Zubehör			
	Für monolithisches Glas	T		
SELL OUT	205029-08	8		4
SELL OUT	205029-10	10		4
SELL OUT	205029-12	12		4

Für laminiertes Glas

SELL OUT	205029-09	8,76		4
SELL OUT	205029-11	10,76		4
SELL OUT	205029-13	12,76		4
SELL OUT	205029-64	13,52		4



MOD 5500

 Q-railing

Glashalter - MOD 5500

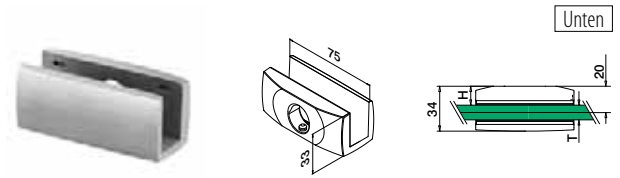
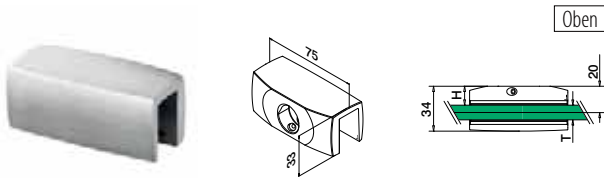

MOD 5500

V4A	316	Gebürstet		
OUTDOOR		T	H	
145500-01-12	Siehe T in MOD 5055		Siehe H in MOD 5055	2



Internationaler Geschmacksmusterschutz

MOD 5500

V4A	316	Gebürstet		
OUTDOOR		T	H	
145500-02-12	Siehe T in MOD 5055		Siehe H in MOD 5055	2



Internationaler Geschmacksmusterschutz

Adapter für MOD 5500

Für flaches Rohr

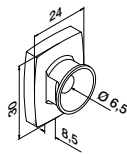

Für rundes Rohr

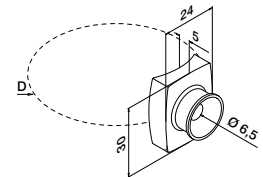

MOD 0785

V4A	316	Gebürstet		
OUTDOOR				
140785-000-12	QS-16	472	4	



MOD 0785

V4A	316	Gebürstet		
OUTDOOR		D		
140785-042-12	42,4	QS-16	472	4
140785-048-12	48,3	QS-16	472	4



Gummieinlagen



1 Stück pro Glasklemme

MOD 5055

Zubehör

Für monolithisches Glas	T	H	
205055-08	8	15,5	2
205055-10	10	14,5	2
205055-12	12	13,5	2

Für laminiertes Glas

205055-08	8,76	15	2
205055-10	10,76	14,5	2
205055-54	11,52	14	2
205055-12	12,76	13,5	2
205055-64	13,52	13	2

Q-INFO MOD 0785

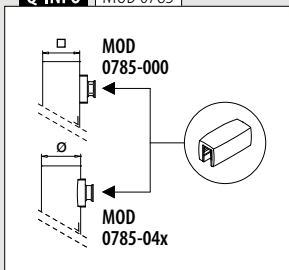

Q-INFO MOD 5500-02

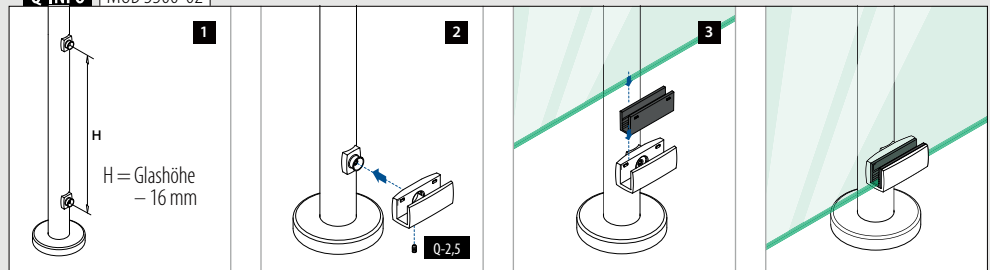

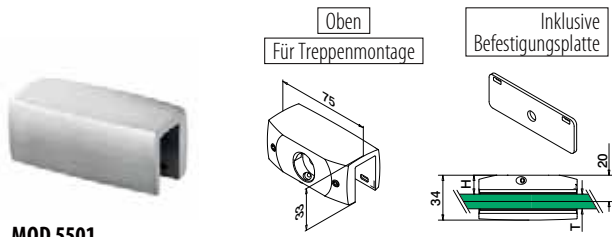

MOD 5501

V4A	316	Gebürstet		
OUTDOOR		T	H	
145501-01-12	Siehe T in MOD 5055		Siehe H in MOD 5055	2



Internationaler Geschmacksmusterschutz

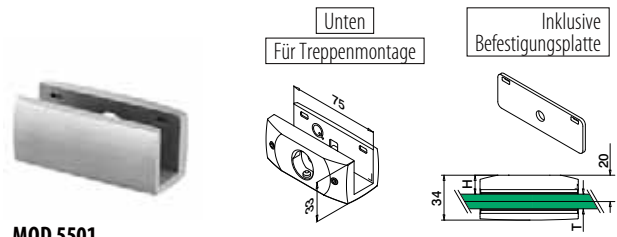

MOD 5501

V4A	316	Gebürstet		
OUTDOOR		T	H	
145501-02-12	Siehe T in MOD 5055		Siehe H in MOD 5055	2



Internationaler Geschmacksmusterschutz



MOD 0786

V4A	316	Gebürstet		
OUTDOOR				
140786-000-12	QS-16	472		2

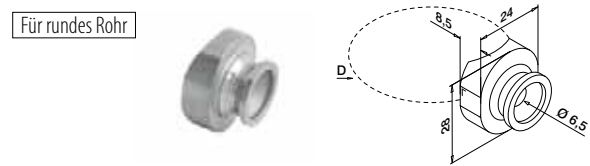

MOD 0786

V4A	316	Gebürstet		
OUTDOOR		D		
140786-042-12	42,4	QS-16	472	2
140786-048-12	48,3	QS-16	472	2

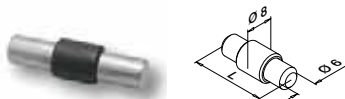

MOD 5015

Zubehör			
	L		
205015-25	25		4

Q-INFO MOD 5501

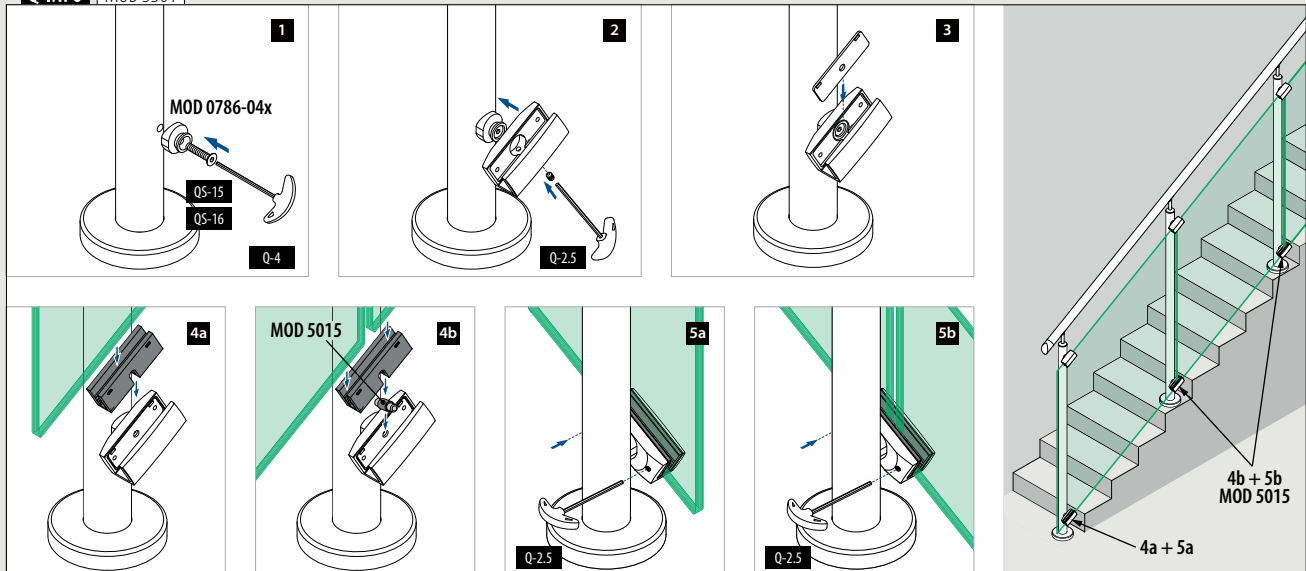

Glasverbinder - MOD 2870 / 2880 / 2890

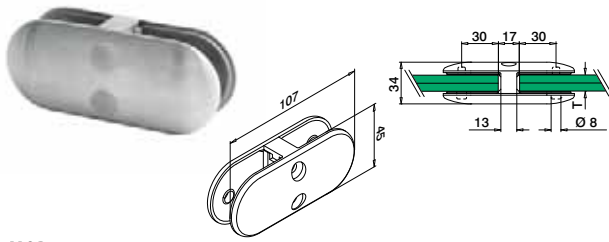

MOD 2870

V2A	304	Gebürstet		
	INDOOR*	T		
	132870-13-12	Siehe T in MOD 5028	2	

V4A	316	Gebürstet		
	OUTDOOR			
	142870-13-12	Siehe T in MOD 5028	2	



Internationaler Geschmacksmusterschutz

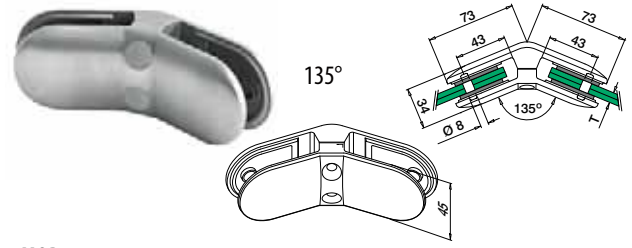

MOD 2880

V4A	316	Gebürstet		
	OUTDOOR	T		
	142880-13-12	Siehe T in MOD 5028	2	



Internationaler Geschmacksmusterschutz

Gummieinlagen für MOD 2870 / 2880 / 2890

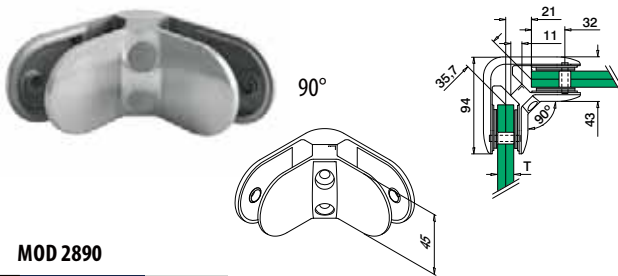

MOD 2890

V2A	304	Gebürstet		
	INDOOR*	T		
	132890-13-12	Siehe T in MOD 5028	2	

V4A	316	Gebürstet		
	OUTDOOR			
	142890-13-12	Siehe T in MOD 5028	2	



Internationaler Geschmacksmusterschutz



4 Stück pro Glasverbinder

MOD 5028

Zubehör

Für monolithisches Glas	T	
205028-06	6	8
205028-08	8	8
205028-10	10	8
205028-12	12	8

Für laminiertes Glas

205028-09	8,76	8
205028-44	9,52	8
205028-11	10,76	8
205028-54	11,52	8
205028-13	12,76	8

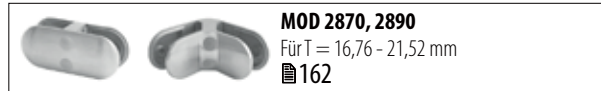

* Auch für Aussenanwendung geeignet bei entsprechenden Bedingungen.

Q-INFO MOD 2870

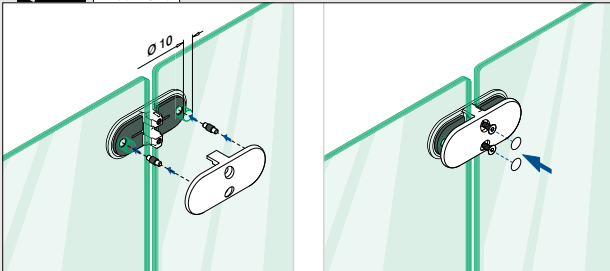

Q-INFO MOD 2880

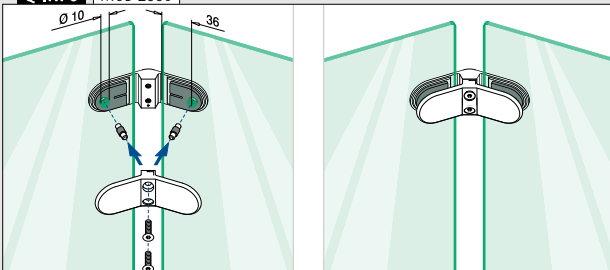

Zubehör

Sicherungsstifte

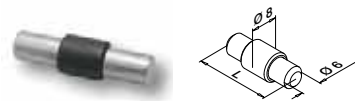

Optional verwendbar für MOD 2870 / 2880 / 2890

MOD 5015

Zubehör

	L	
205015-22	22	4

Q-INFO MOD 2890

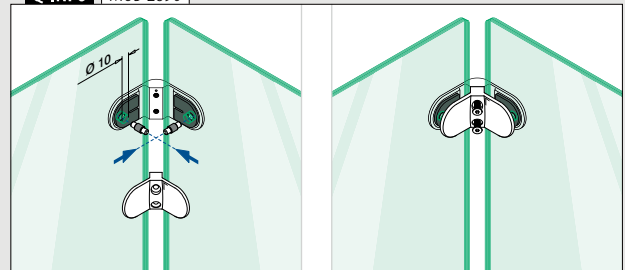

Glasverbinder - MOD 4270 / 4280 / 4290

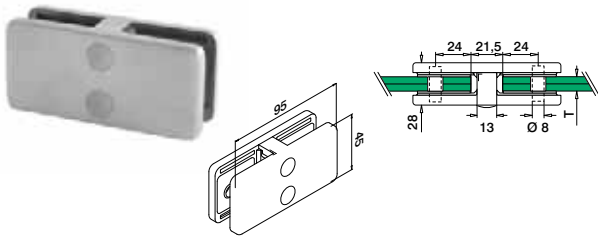

MOD 4270

V2A	304	Gebürstet		
	INDOOR*	T		
	134270-13-12	Siehe T in MOD 5042		2
V4A	316	Gebürstet		
	OUTDOOR			
	144270-13-12	Siehe T in MOD 5042		2



Internationaler Geschmacksmusterschutz

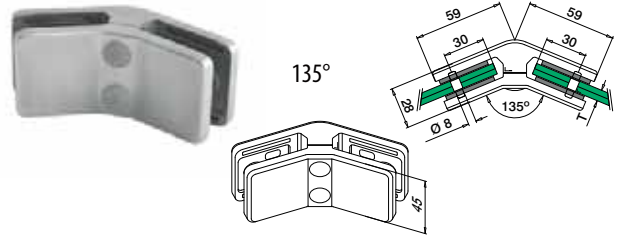

MOD 4280

V4A	316	Gebürstet		
	OUTDOOR	T		
	144280-13-12	Siehe T in MOD 5042		2



Internationaler Geschmacksmusterschutz

Gummieinlagen für MOD 4270 / 4280 / 4290

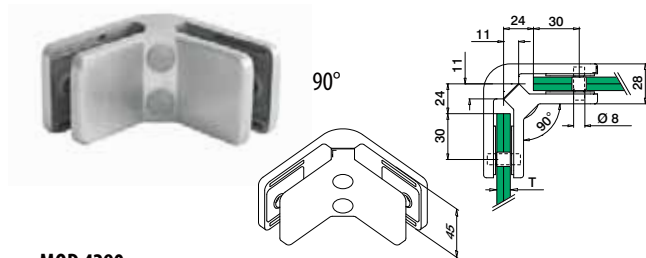

MOD 4290

V2A	304	Gebürstet		
	INDOOR*	T		
	134290-13-12	Siehe T in MOD 5042		2
V4A	316	Gebürstet		
	OUTDOOR			
	144290-13-12	Siehe T in MOD 5042		2



4 Stück pro Glasverbinder

MOD 5042

Zubehör

Für monolithisches Glas		T	
205042-06	6		8
205042-08	8		8
205042-10	10		8
205042-12	12		8

Für laminiertes Glas

205042-07	6,76	8
205042-41	8,38	8
205042-09	8,76	8
205042-44	9,52	8
205042-11	10,76	8
205042-54	11,52	8
205042-13	12,76	8

Sicherungsstifte

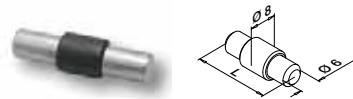

Optional verwendbar für MOD 4270 / 4280 / 4290

MOD 5015

Zubehör

	L	
205015-22	22	4

Q-INFO MOD 4270

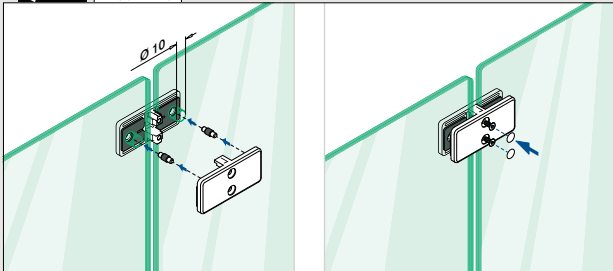

Q-INFO MOD 4280

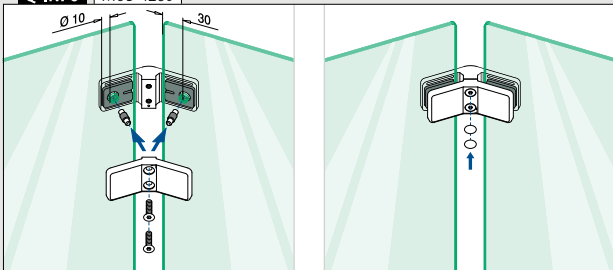

Q-INFO MOD 4290

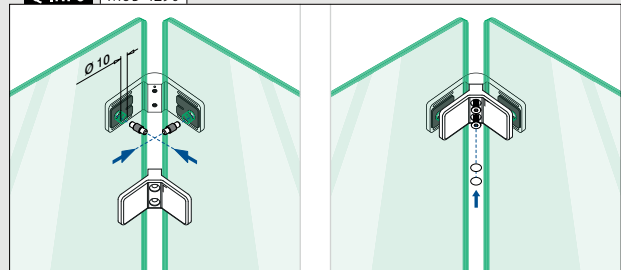

Glas - Glas

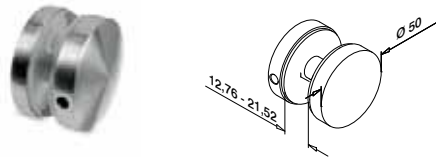

MOD 0742

V2A	304	Gebürstet	
INDOOR			
130742-12			2
V4A	316	Gebürstet	
OUTDOOR			
140742-12			2
V4A	316	Hochglanzpoliert	
OUTDOOR			
140742-10			2



Türriegel

Für flaches Rohr

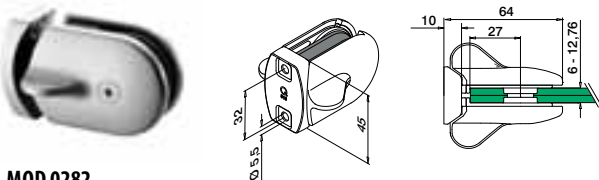

MOD 0282

V4A	316	Gebürstet	
OUTDOOR			
140282-000	QS-13	472	1



Internationaler Geschmacksmusterschutz

Für rundes Rohr

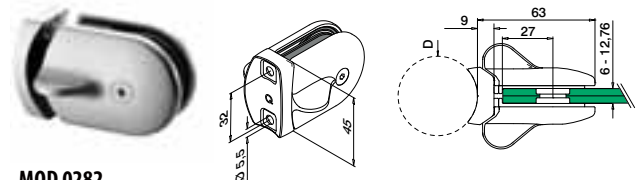

MOD 0282

V4A	316	Gebürstet	D	
OUTDOOR				
140282-042	42,4	QS-13	472	1
140282-048	48,3	QS-13	472	1



Internationaler Geschmacksmusterschutz

Glas - Glas

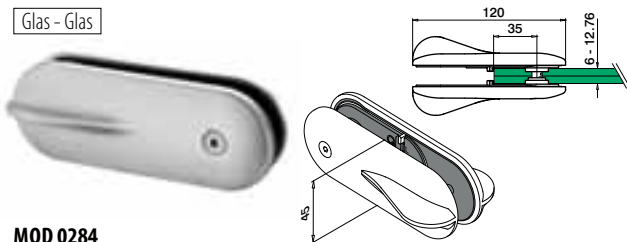

MOD 0284

V4A	316	Gebürstet	
OUTDOOR			
140284			1



Internationaler Geschmacksmusterschutz

* Auch für Aussenanwendung geeignet bei entsprechenden Bedingungen.

Bitte bestellen Sie Befestigungsmaterial separat.

Q-INFO 304 316

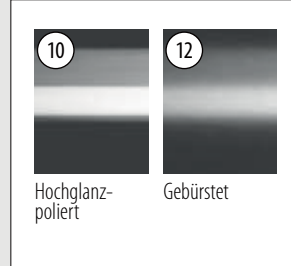

Q-INFO MOD 0742

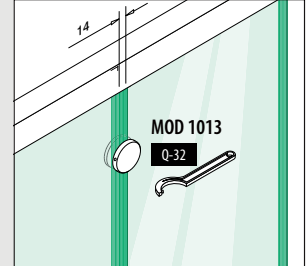

Q-INFO MOD 0284

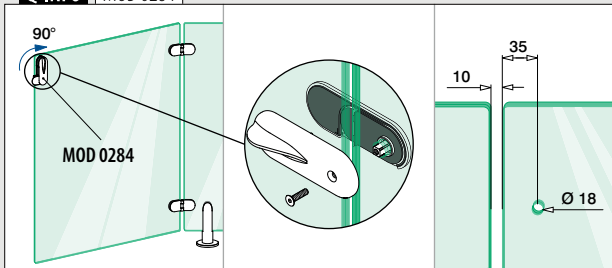

Q-INFO MOD 0282

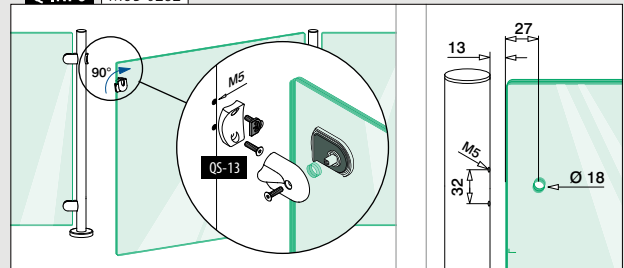

Scharniere

Für flaches Rohr

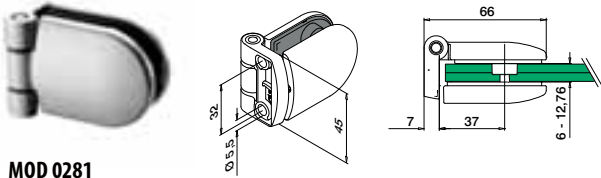

MOD 0281

Für rundes Rohr

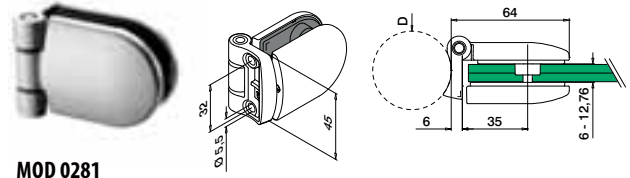

MOD 0281

V4A	316	Gebürstet	
	OUTDOOR		
140281-000	QS-13	472	2



Internationaler Geschmacksmusterschutz

V4A	316	Gebürstet	
	OUTDOOR	D	
140281-042	42,4	QS-13	472
140281-048	48,3	QS-13	472



Internationaler Geschmacksmusterschutz

Glas - Glas

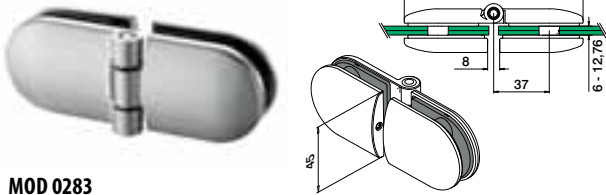

MOD 0283

V4A	316	Gebürstet	
	OUTDOOR		
140283			2



Internationaler Geschmacksmusterschutz

V4A Q-INFO MOD 0283

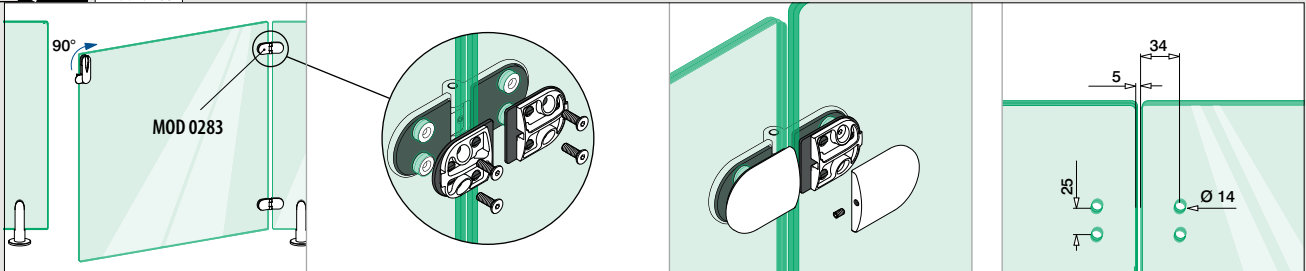

Q-INFO MOD 0281

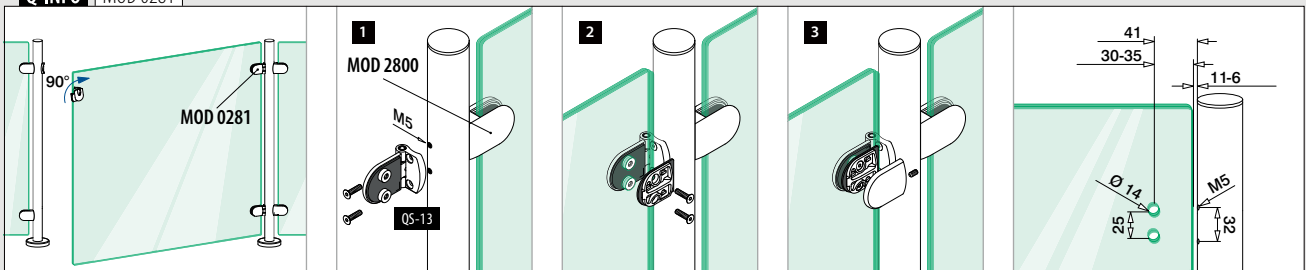



MOD 0754

Für flaches Rohr

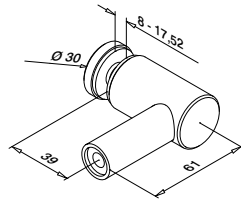

MOD 0754

V4A	316	Gebürstet		
OUTDOOR				
140754-000-12	QS-30	472		4



Internationaler Geschmacksmusterschutz

Für rundes Rohr

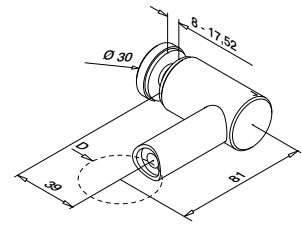

MOD 0754

V4A	316	Gebürstet		
OUTDOOR		D		
140754-042-12		42,4	QS-30	472
140754-048-12		48,3	QS-30	472



Internationaler Geschmacksmusterschutz

Bitte bestellen Sie Befestigungsmaterial separat.

Q-INFO

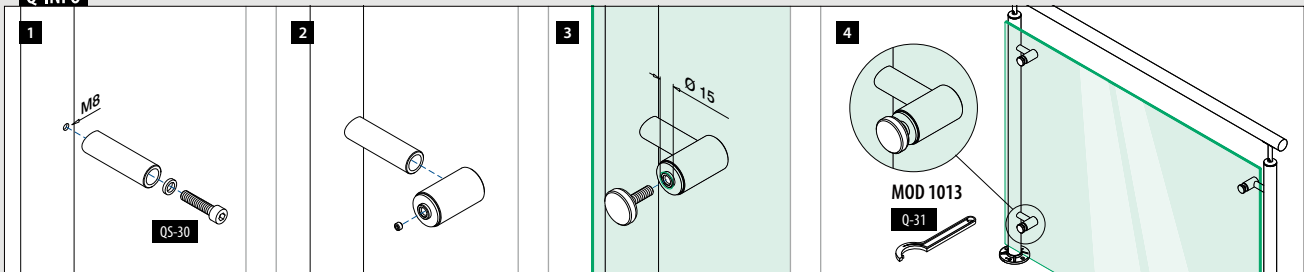

Für flaches Rohr



MOD 0746

V2A	304	Gebürstet	INDOOR*	H	L	L1	
			130746-015-12	15	50	10 - 22	4
			130746-020-12	20	60	14 - 26	4
			130746-030-12	30	70	14 - 26	4
			130746-040-12	40	80	14 - 26	4
			130746-050-12	50	90	14 - 26	4

V4A	316	Gebürstet	OUTDOOR	H	L	L1	
			140746-015-12	15	50	10 - 22	4

V4A	316	Hochglanzpoliert	OUTDOOR	H	L	L1	
SELL OUT			140746-015-10	15	50	10 - 22	4

Zinkdruckguss
INDOOR

SELL OUT	100746-...		15	50	10 - 22	4	
----------	------------	--	----	----	---------	---	--



Für rundes Rohr



MOD 0746

V2A	304	Gebürstet	INDOOR*	D	L1	
SELL OUT			130746-033-12	33,7	10 - 22	4
SELL OUT			130746-042-12	42,4	10 - 22	4
SELL OUT			130746-048-12	48,3	10 - 22	4

V4A	316	Gebürstet	OUTDOOR	D	L1	
SELL OUT			140746-033-12	33,7	10 - 22	4
SELL OUT			140746-042-12	42,4	10 - 22	4
SELL OUT			140746-048-12	48,3	10 - 22	4
SELL OUT			140746-060-12	60,3	10 - 22	4



MOD 0740

V2A	304	Gebürstet	INDOOR*	
SELL OUT			130740-12	4

V4A	316	Gebürstet	OUTDOOR	
			140740-12	4

V4A	316	Hochglanzpoliert	OUTDOOR	
SELL OUT			140740-10	4



MOD 0755

V2A	304	Gebürstet	INDOOR*	Ø	
SELL OUT			130755-16	16	4

V4A	316	Gebürstet	OUTDOOR	Ø	
SELL OUT			140755-12	12	4



Q-INFO 316

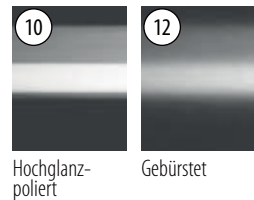

Q-INFO MOD 0746

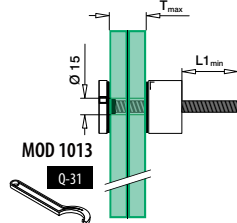

Q-INFO MOD 0755

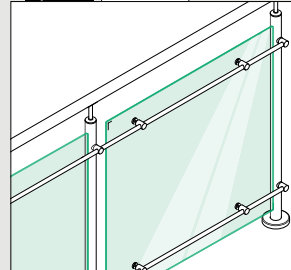

Q-INFO MOD 0755

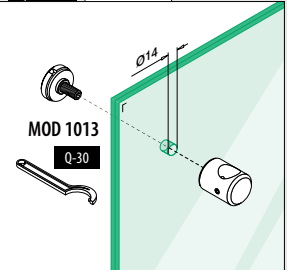

Q-INFO Zinkdruckguss MOD 0746 Oberflächen



Q-INFO



Für flaches Rohr

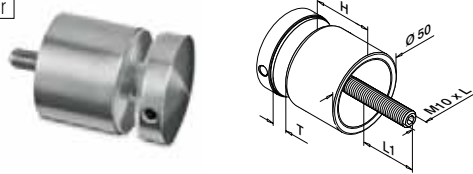

MOD 0747

V2A	304	Gebürstet	INDOOR*	H	T	L	L1	
				10	8 - 17,52	50	11 - 22	2
				20	8 - 25,52	70	13 - 31	2
				30	8 - 25,52	80	13 - 31	2
				40	8 - 17,52	80	11 - 22	2
				50	8 - 17,52	90	11 - 22	2

V2A	304	Black Line	INDOOR*	H	T	L	L1	
				10	8 - 17,52	50	11 - 22	2
				30	8 - 25,52	80	13 - 31	2

V4A	316	Gebürstet	OUTDOOR	H	T	L	L1	
				10	8 - 17,52	50	11 - 22	2
				20	8 - 25,52	70	13 - 31	2
				30	8 - 25,52	80	13 - 31	2
				40	8 - 17,52	80	11 - 21	2
				50	8 - 17,52	90	11 - 21	2

V4A	316	Hochglanzpoliert	OUTDOOR	H	T	L	L1	
				30	8 - 25,52	80	13 - 31	2

Zinkdruckguss	Roh	INDOOR	H	T	L	L1	
			10	8 - 17,52	50	11 - 22	2

Zinkdruckguss	Edelstahleffekt	OUTDOOR	H	T	L	L1	
			10	8 - 17,52	50	11 - 22	2

Zinkdruckguss	Edelstahleffekt	OUTDOOR	H	T	L	L1	
			10	8 - 17,52	50	11 - 22	2



Für rundes Rohr

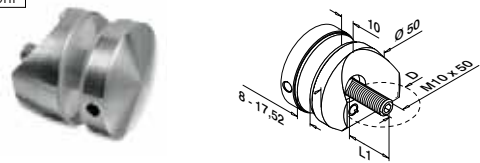

MOD 1747

V2A	304	Gebürstet	INDOOR*	D	L1	
				42,4	10 - 20	2
				48,3	10 - 20	2

V4A	316	Gebürstet	OUTDOOR	D	L1	
				42,4	10 - 20	2



Q-INFO Zinkdruckguss

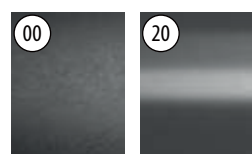

Roh Edelstahleffekt

Q-INFO



Artikel mit .00-Ausführung können pulverbeschichtet werden.

Q-INFO 304 316



Hochglanzpoliert

Gebürstet

Schwarz, matt, strukturiert

* Auch für Aussenanwendung geeignet bei entsprechenden Bedingungen.

SELL OUT Nur solange der Vorrat reicht.

Q-INFO MOD 0747

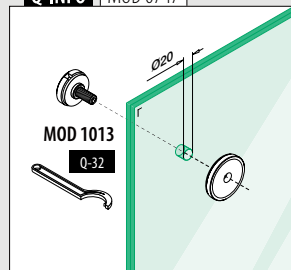

Q-INFO MOD 1747

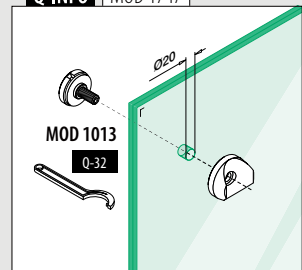







6

ZUBEHÖR

Übersicht Q-Schrauben / Q-Anker	456
Finden Sie den richtigen Anker	457 - 463
Anker	464 - 467
Schrauben	468 - 472
Befestigungsmaterial	473 - 474
Ersatzmaterial für Glasklemmen/Glasadapter	475
Bohren und Gewindeschneiden	476 - 477
Montagezubehör	478 - 481
Pflege und Reinigung	482
Werkzeug	483 - 485
Symbolverzeichnis	487

Schrauben schneller bestellen. Eine Zusammenfassung der Seiten 464 - 480.

QS	#		
QS-1	230205-050	50	471
QS-2	240205-050	50	471
QS-3	230200-760	50	471
QS-4	240200-760	50	471
QS-5	230210-025	50	471
QS-6	240210-025	50	471
QS-7	230210-038	50	471
QS-8	230230-025	50	471
QS-9	240230-025	50	471
QS-10	230690-516	50	472
QS-11	240690-516	50	472
QS-12	230670-520	50	472
QS-13	240670-520	50	472
QS-14	230670-620	50	472
QS-15	230670-625	50	472
QS-16	240670-625	50	472
QS-17	230670-630	50	472
QS-18	240670-630	50	472
QS-19	230670-825	50	472
QS-20	240670-825	50	472
QS-21	230670-840	50	472
QS-22	240670-840	50	472
QS-23	230680-620	50	472
QS-24	230680-635	50	472
QS-25	230680-660	50	472
QS-26	230680-820	50	472
QS-27	240680-820	50	472
QS-28	250680-820	50	472
QS-29	230680-835	50	472
QS-30	240680-835	50	472
QS-32	244010-212	10	464
QS-33	254010-212	10	464
QS-34	244110-875	10	467
QS-35	254110-875	10	467
QS-36	254210-212	25	467
QS-38	230800-616	50	474
QS-39	230800-817	50	474
QS-40	230800-121	50	474
QS-41	240670-616	50	475
QS-42	240670-620	50	475
QS-43	250670-616	50	475
QS-44	250670-620	50	475
QS-45	240681	50	474
QS-46	250681	50	474
QS-47	230681	50	474
QS-48	230670-612	50	472
QS-49	230211-340	50	471
QS-50	240210-038	50	471
QS-51	200842	50	480
QS-53	240680-620	50	472
QS-54	230680-645	50	472
QS-55	200851-827	50	470
QS-56	230230-038	50	471
QS-57	240230-038	50	471
QS-58	244110-190	10	467
QS-59	254110-190	10	467
QS-60	244010-217	10	464
QS-62	244010-880	10	464
QS-63	254010-880	10	464
QS-64	244010-185	10	464
QS-65	254010-185	10	464
QS-66	250803-120	50	478
QS-67	230680-140	50	472
QS-69	230803-818	50	478
QS-70	240680-645	50	472
QS-71	240680-660	50	472
QS-72	240680-140	50	472
QS-74	240670-240	50	472
QS-80	240800-616	50	474
QS-81	240800-817	50	474
QS-82	240800-121	50	474
QS-83	230690-616	50	472
QS-84	240690-616	50	472
QS-85	230205-090	50	471
QS-86	240205-090	50	471
QS-87	200841-635	100	470
QS-89	240670-612	50	472
QS-90	240400-505	50	472
QS-91	230400-505	50	472
QS-92	240400-610	50	472
QS-93	240490-506	50	472
QS-94	230490-506	50	472
QS-200	230240-412	50	471
QS-202	230690-510	50	472
QS-203	240690-510	50	472

QS	#		
QS-205	240670-608	50	472
QS-207	244510-290	10	465
QS-208	254510-290	10	465
QS-211	244510-212	10	465
QS-212	254510-212	10	465
QS-213	244260-180	50	468
QS-214	244250-180	50	468
QS-215	240663-224	50	473
QS-216	250663-224	50	473
QS-217	240664-220	50	473
QS-219	240661-235	50	473
QS-221	240662-230	50	473
QS-222	250662-230	50	473
QS-223	240661-230	50	473
QS-224	250661-230	50	473
QS-225	240661-245	50	473
QS-250	250260-008	50	469
QS-251	250260-012	50	469
QS-255	250250-808	50	469
QS-256	250250-812	50	469
QS-258	250250-012	50	469
QS-261	240690-608	50	472
QS-264	230250-608	50	469
QS-265	230250-610	50	469
QS-266	240915-550	50	469
QS-267	240212-438	50	471
QS-268	240212-413	50	471
QS-270	254410-811	10	464
QS-271	244410-811	10	464
QS-272	254410-113	10	464
QS-273	244410-113	10	464
QS-274	254410-215	10	464
QS-275	244410-215	10	464
QS-276	254410-217	10	464
QS-277	244410-217	10	464
QS-281	254410-820	10	464
QS-282	244410-820	10	464
QS-284	254410-226	10	464
QS-285	244410-226	10	464
QS-286	240665-232	50	468
QS-287	240666-816	50	473
QS-288	230491-850	50	470
QS-289	240651-208	50	473
QS-290	250251-010	25	469
QS-503	230210-060	50	471
QS-504	240210-060	50	471
QS-505	254510-210	10	465
QS-507	254010-217	10	464
QS-512	200203	50	478
QS-513	240650-865	50	473
QS-514	230650-865	50	473
QS-515	240650-108	50	473
QS-516	240650-210	50	473
QS-517	230650-108	50	473
QS-518	230650-210	50	473
QS-519	244210-212	25	467
QS-520	244510-180	10	465
QS-521	254510-180	10	465
QS-528	254510-875	10	465
QS-529	244510-875	10	465
QS-530	240670-135	50	472
QS-531	230670-135	50	472
QS-532	230670-130	50	472
QS-533	240670-130	50	472
QS-549	244010-213	10	464
QS-551	230680-240	50	472
QS-555	200841-160	50	470
QS-556	240200-890	50	471
QS-557	244519-290	10	465
QS-558	254519-290	10	465
QS-559	244519-210	10	465
QS-560	244220-285	25	467
QS-561	254220-285	25	467
QS-562	244220-211	25	467
QS-563	254220-211	25	467
QS-570	200843-008	25	470
QS-571	254300-110	50	468
QS-572	244300-110	50	468
QS-573	244300-112	50	468
QS-574	254310-110	50	468
QS-575	244310-110	50	468
QS-576	254310-112	50	468
QS-577	244310-112	50	468
QS-578	244310-870	50	468
QS-579	230805-665	2	469

FINDEN SIE DEN RICHTIGEN ANKER FÜR IHR PROJEKT

Bitte prüfen Sie vor dem Kauf die entsprechenden lokalen Normen bezüglich der Verwendung von Anker.











Finden Sie alle Informationen zu Q-pac online:













<https://q-ne.ws/QPac23>

Die Anker in dieser Übersicht sind NICHT berechnet oder getestet, sondern lediglich eine Empfehlung basierend auf dem Q-railing Sortiment. Andere Anker und Optionen sind möglich. Unsere Services, wie Q-pac und Ankertabellen, helfen Ihnen bei der Wahl der richtigen Anker für Ihre Projekte. Bei Fragen kontaktieren Sie gerne auch Ihren Verkaufsberater.

















EASY GLASS® SMART / SMART+ / PRIME

Montage	t (mm)	Anker	QS	Typ	Verwendung	Schraube / Bolzen	QS	Typ	Verwendung			
 MOD 8210 / 8410 MOD 8310	7 / 8,5	Chemisch	FÜR BETON					FÜR STAHL				
			QS-276	QVMU-A M12x175	INDOOR	464		QS-224	M12 x 30	INDOOR	473	
			QS-277	QVMU-A M12x175 A4	OUTDOOR	464		+ QS-216	Für M12	INDOOR	473	
			QS-207	QVMZ-IG 90 M12 A4	OUTDOOR	465		QS-223	M12 x 30	OUTDOOR	473	
			+ QS-225	M12 x 45	OUTDOOR	473		+ QS-215	Für M12	OUTDOOR	473	
		+ QS-215	Für M12	OUTDOOR	473	QS-225		M12 x 45	OUTDOOR	473		
		Mechanisch	FÜR STAHL						FÜR HOLZ			
			QS-574	QBSZ SU 10x100	INDOOR	468			QS-258	10 x 120	INDOOR	469
			QS-575	QBSZ SU 10x100 A4	OUTDOOR	468			QS-290	10 x 100	OUTDOOR	469
			QS-576	QBSZ SU 10x120	INDOOR	468						
			QS-577	QBSZ SU 10x120 A4	OUTDOOR	468						
			QS-560	QSZ 12/10 A4	OUTDOOR	467						
			QS-561	QSZ-S 12/10	INDOOR	467						
			QS-562	QSZ 12/30 A4	OUTDOOR	467						
			QS-563	QSZ-S 12/30	INDOOR	467						
 MOD 8220 / 8420	15 / 20		Chemisch	FÜR BETON						FÜR STAHL		
		QS-276		QVMU-A M12x175	INDOOR	464	QS-225	M12 x 45		OUTDOOR	473	
		QS-277		QVMU-A M12x175 A4	OUTDOOR	464	+ QS-215	Für M12		OUTDOOR	473	
		QS-207		QVMZ-IG 90 M12 A4	OUTDOOR	465						
		+ QS-225		M12 x 45	OUTDOOR	473	FÜR HOLZ					
		+ QS-215	Für M12	OUTDOOR	473	QS-258	10 x 120	INDOOR		469		
		Mechanisch	QS-290	10 x 100	OUTDOOR	469						
			QS-562	QSZ 12/30 A4	OUTDOOR	467						
			QS-563	QSZ-S 12/30	INDOOR	467						
			QS-576	QBSZ SU 10x120	INDOOR	468						
QS-577	QBSZ SU 10x120 A4		OUTDOOR	468								
 MOD 8230 / 8430 MOD 8330	4 / 5	Chemisch	FÜR BETON					FÜR STAHL				
			QS-207	QVMZ-IG 90 M12 A4	OUTDOOR	465		QS-224	M12 x 30	INDOOR	473	
			+ QS-225	M12 x 45	OUTDOOR	473		+ QS-216	Für M12	INDOOR	473	
			+ QS-215	Für M12	OUTDOOR	473		QS-223	M12 x 30	OUTDOOR	473	
								+ QS-215	Für M12	OUTDOOR	473	
		Mechanisch	FÜR STAHL						FÜR HOLZ			
			QS-571	QBSZ SK 10x100	INDOOR	468			QS-225	M12 x 45	OUTDOOR	473
			+ QS-286	Für QBSZ SK 10	INDOOR	468			+ QS-215	Für M12	OUTDOOR	473
			QS-572	QBSZ SK 10x100 A4	OUTDOOR	468						
			+ QS-286	Für QBSZ SK 10	OUTDOOR	468			QS-258	10 x 120	INDOOR	469
			QS-573	QBSZ SK 10x120 A4	OUTDOOR	468			QS-290	10 x 100	OUTDOOR	469
			+ QS-286	Für QBSZ SK 10	OUTDOOR	468						
			QS-560	QSZ 12/10 A4	OUTDOOR	467						
			QS-561	QSZ-S 12/10	INDOOR	467						
			QS-562	QSZ 12/30 A4	OUTDOOR	467						
QS-563	QSZ-S 12/30	INDOOR	467									
 MOD 8240 / 8440	5 / 5	Chemisch	FÜR BETON					FÜR STAHL				
			QS-276	QVMU-A M12x175	INDOOR	464		QS-224	M12 x 30	INDOOR	473	
			QS-277	QVMU-A M12x175 A4	OUTDOOR	464		+ QS-216	Für M12	INDOOR	473	
			QS-207	QVMZ-IG 90 M12 A4	OUTDOOR	465		QS-223	M12 x 30	OUTDOOR	473	
			+ QS-225	M12 x 45	OUTDOOR	473		+ QS-215	Für M12	OUTDOOR	473	
		+ QS-215	Für M12	OUTDOOR	473	QS-225		M12 x 45	OUTDOOR	473		
		Mechanisch	FÜR STAHL						FÜR HOLZ			
			QS-574	QBSZ SU 10x100	INDOOR	468			QS-258	10 x 120	INDOOR	469
			QS-575	QBSZ SU 10x100 A4	OUTDOOR	468			QS-290	10 x 100	OUTDOOR	469
			QS-576	QBSZ SU 10x120	INDOOR	468						
			QS-577	QBSZ SU 10x120 A4	OUTDOOR	468						
			QS-560	QSZ 12/10 A4	OUTDOOR	467						
			QS-561	QSZ-S 12/10	INDOOR	467						













EASY GLASS® SLIM

Montage	t (mm)	Anker	QS	Typ	Verwendung	Schraube / Bolzen	QS	Typ	Verwendung				
 MOD 8010	12,5		FÜR BETON				FÜR STAHL						
			QS-36	Q SZ-SK 12/50	INDOOR		467	QS-531	M10 x 35	INDOOR	472		
			QS-519	Q SZ-SK 12/50 A4	OUTDOOR		467	QS-530	M10 x 35	OUTDOOR	472		
			QS-571	Q BSZ SK 10x100	INDOOR		468	FÜR HOLZ					
			QS-572	Q BSZ SK 10x100 A4	OUTDOOR		468	QS-251	10 x 120	INDOOR	469		
			QS-573	Q BSZ SK 10x120 A4	OUTDOOR		468						
 MOD 8020	10,5		FÜR BETON				FÜR STAHL						
			QS-276	Q VMU-A M12x175	INDOOR		464	QS-223	M12 x 30	OUTDOOR	473		
			QS-277	Q VMU-A M12x175 A4	OUTDOOR		464	+ QS-215	Für M12	OUTDOOR	473		
			QS-207	Q VMZ-IG 90 M12 A4	OUTDOOR		465	QS-225	M12 x 45	OUTDOOR	473		
			+ QS-225	M12 x 45	OUTDOOR		473	+ QS-215	Für M12	OUTDOOR	473		
			+ QS-215	Für M12	OUTDOOR		473	FÜR HOLZ					
			QS-562	Q SZ 12/30 A4	OUTDOOR	467	QS-258	10 x 120	INDOOR	469			
			QS-563	Q SZ-S 12/30	INDOOR	467	QS-290	10 x 100	OUTDOOR	469			
			QS-576	Q BSZ SU 10x120	INDOOR	468							
			QS-577	Q BSZ SU 10x120 A4	OUTDOOR	468							
			 MOD 8030	7		FÜR BETON				FÜR STAHL			
						QS-36	Q SZ-SK 12/50	INDOOR		467	QS-74	M12 x 40	OUTDOOR
QS-519	Q SZ-SK 12/50 A4	OUTDOOR				467	FÜR HOLZ						
QS-571	Q BSZ SK 10x100	INDOOR				468	QS-250	10 x 80		INDOOR	469		
QS-572	Q BSZ SK 10x100 A4	OUTDOOR				468	QS-251	10 x 120		INDOOR	469		
QS-573	Q BSZ SK 10x120 A4	OUTDOOR				468							









EASY GLASS® PRO

Montage	t (mm)	Anker	QS	Typ	Verwendung	Schraube / Bolzen	QS	Typ	Verwendung				
 MOD 8110	7,5		FÜR BETON				FÜR STAHL						
			QS-558	Q VMZ-IG 90 M12	INDOOR		465	QS-222	M12 x 30	INDOOR	473		
		QS-557	Q VMZ-IG 90 M12 A4	OUTDOOR	465		+ QS-217	Für M12	INDOOR	473			
			QS-574	Q BSZ SU 10x100	INDOOR		468	QS-221	M12 x 30	OUTDOOR	473		
			QS-575	Q BSZ SU 10x100 A4	OUTDOOR		468	+ QS-217	Für M12	OUTDOOR	473		
			QS-576	Q BSZ SU 10x120	INDOOR		468	FÜR HOLZ					
			QS-577	Q BSZ SU 10x120 A4	OUTDOOR		468	QS-258	10 x 120	INDOOR	469		
			QS-560	Q SZ 12/10 A4	OUTDOOR		467	QS-290	10 x 100	OUTDOOR	469		
			QS-561	Q SZ-S 12/10	INDOOR		467						
		 MOD 8120	12		FÜR BETON				FÜR STAHL				
QS-276	Q VMU-A M12x175				INDOOR	464	QS-219		M12 x 35	OUTDOOR	473		
QS-277	Q VMU-A M12x175 A4				OUTDOOR	464	+ QS-215		Für M12	OUTDOOR	473		
QS-207	Q VMZ-IG 90 M12 A4				OUTDOOR	465	QS-225		M12 x 45	OUTDOOR	473		
+ QS-225	M12 x 45				OUTDOOR	473	+ QS-215		Für M12	OUTDOOR	473		
+ QS-215	Für M12				OUTDOOR	473	FÜR HOLZ						
	QS-562			Q SZ 12/30 A4	OUTDOOR	467	QS-258	10 x 120	INDOOR	469			
	QS-563			Q SZ-S 12/30	INDOOR	467	QS-290	10 x 100	OUTDOOR	469			
	QS-576			Q BSZ SU 10x120	INDOOR	468							
	QS-577			Q BSZ SU 10x120 A4	OUTDOOR	468							
	 MOD 8130 / 8150			5,5 / 5,5		FÜR BETON				FÜR STAHL			
						QS-558	Q VMZ-IG 90 M12	INDOOR		465	QS-222	M12 x 30	INDOOR
QS-557		Q VMZ-IG 90 M12 A4	OUTDOOR		465	+ QS-217	Für M12	INDOOR		473			
		QS-560	Q SZ 12/10 A4		OUTDOOR	467	QS-221	M12 x 30		OUTDOOR	473		
		QS-561	Q SZ-S 12/10		INDOOR	467	+ QS-217	Für M12		OUTDOOR	473		
						FÜR HOLZ							
					QS-258	10 x 120	INDOOR	469					
 MOD 8140	4,5		FÜR BETON				FÜR STAHL						
			QS-558	Q VMZ-IG 90 M12	INDOOR		465	QS-222	M12 x 30	INDOOR	473		
		QS-557	Q VMZ-IG 90 M12 A4	OUTDOOR	465		+ QS-217	Für M12	INDOOR	473			
			QS-574	Q BSZ SU 10x100	INDOOR		468	QS-551	M12 x 40	INDOOR	472		
			QS-575	Q BSZ SU 10x100 A4	OUTDOOR		468	+ QS-217	Für M12	INDOOR	473		
			QS-576	Q BSZ SU 10x120	INDOOR		468	QS-221	M12 x 30	OUTDOOR	473		
			QS-577	Q BSZ SU 10x120 A4	OUTDOOR		468	+ QS-217	Für M12	OUTDOOR	473		
			QS-560	Q SZ 12/10 A4	OUTDOOR		467	FÜR HOLZ					
			QS-561	Q SZ-S 12/10	INDOOR		467	QS-258	10 x 120	INDOOR	469		
							QS-290	10 x 100	OUTDOOR	469			













EASY GLASS® MAX / STRONG

Montage	t (mm)	Anker	QS	Typ	Verwendung	Schraube / Bolzen	QS	Typ	Verwendung	
 MOD 8510 MOD 8610	9,5		FÜR BETON				FÜR STAHL			
			QS-208	Q VMZ-IG 90 M12	INDOOR		465	QS-224	M12 x 30	INDOOR
			+ QS-224	M12 x 30	INDOOR	473	+ QS-216	Für M12	INDOOR	473
			+ QS-216	Für M12	INDOOR	473	QS-223	M12 x 30	OUTDOOR	473
			QS-207	Q VMZ-IG 90 M12 A4	OUTDOOR	465	+ QS-215	Für M12	OUTDOOR	473
			+ QS-219	M12 x 35	OUTDOOR	473	QS-225	M12 x 45	OUTDOOR	473
			+ QS-215	Für M12	OUTDOOR	473	+ QS-215	Für M12	OUTDOOR	473
 MOD 8520	9,5		FÜR BETON				FÜR STAHL			
			QS-276	Q VMU-A M12x175	INDOOR		464	QS-225	M12 x 45	OUTDOOR
			QS-277	Q VMU-A M12x175 A4	OUTDOOR	464	+ QS-215	Für M12	OUTDOOR	473
			QS-207	Q VMZ-IG 90 M12 A4	OUTDOOR	465				
			+ QS-225	M12 x 45	OUTDOOR	473				
			+ QS-215	Für M12	OUTDOOR	473				
 MOD 8530 MOD 8630	26,5		FÜR BETON				FÜR STAHL			
			QS-208	Q VMZ-IG 90 M12	INDOOR		465	QS-224	M12 x 30	INDOOR
			+ QS-224	M12 x 30	INDOOR	473	+ QS-216	Für M12	INDOOR	473
			+ QS-216	Für M12	INDOOR	473	QS-223	M12 x 30	OUTDOOR	473
			QS-207	Q VMZ-IG 90 M12 A4	OUTDOOR	465	+ QS-215	Für M12	OUTDOOR	473
			+ QS-219	M12 x 35	OUTDOOR	473	QS-225	M12 x 45	OUTDOOR	473
			+ QS-215	Für M12	OUTDOOR	473	+ QS-215	Für M12	OUTDOOR	473
 MOD 8540	8		FÜR BETON				FÜR STAHL			
			QS-276	Q VMU-A M12x175	INDOOR		464	QS-224	M12 x 30	INDOOR
			QS-277	Q VMU-A M12x175 A4	OUTDOOR	464	+ QS-216	Für M12	INDOOR	473
			QS-207	Q VMZ-IG 90 M12 A4	OUTDOOR	465	QS-219	M12 x 35	OUTDOOR	473
			+ QS-219	M12 x 35	OUTDOOR	473	+ QS-215	Für M12	OUTDOOR	473
			+ QS-215	Für M12	OUTDOOR	473	QS-225	M12 x 45	OUTDOOR	473
							+ QS-215	Für M12	OUTDOOR	473





EASY GLASS® UP

Montage	t (mm)	Anker	QS	Typ	Verwendung	Schraube / Bolzen	QS	Typ	Verwendung	
 MOD 6610	5,5		FÜR BETON				FÜR STAHL			
			QS-558	Q VMZ-IG 90 M12	INDOOR		465	QS-221	M12 x 30	OUTDOOR
			QS-557	Q VMZ-IG 90 M12 A4	OUTDOOR	465	+ QS-217	Für M12	OUTDOOR	473
			QS-560	Q SZ 12/10 A4	OUTDOOR	467				
			QS-561	Q SZ-S 12/10	INDOOR	467				
 MOD 6620	4,5		FÜR BETON				FÜR STAHL			
			QS-558	Q VMZ-IG 90 M12	INDOOR		465	QS-221	M12 x 30	OUTDOOR
			QS-557	Q VMZ-IG 90 M12 A4	OUTDOOR	465	+ QS-217	Für M12	OUTDOOR	473
			QS-560	Q SZ 12/10 A4	OUTDOOR	467				
			QS-561	Q SZ-S 12/10	INDOOR	467				

EASY GLASS® BODENGLASKLEMMEN

Montage	t (mm)	Anker	QS	Typ	Verwendung	Schraube / Bolzen	QS	Typ	Verwendung	
 MOD 6000	12		FÜR BETON				FÜR STAHL			
			QS-276	Q VMU-A M12x175	INDOOR		464	QS-551	M12 x 40	INDOOR
			QS-277	Q VMU-A M12x175 A4	OUTDOOR	464	+ QS-217	Für M12	INDOOR	473
			QS-507	Q VMU-A M12x175	INDOOR	464	QS-221	M12 x 30	OUTDOOR	473
			QS-60	Q VMU-A M12x175 A4	OUTDOOR	464	+ QS-217	Für M12	OUTDOOR	473
 MOD 6400	11,5		FÜR BETON				FÜR STAHL			
			QS-507	Q VMU-A M12x175	INDOOR		464	QS-551	M12 x 40	INDOOR
			QS-60	Q VMU-A M12x175 A4	OUTDOOR	464	+ QS-217	Für M12	INDOOR	473
			QS-276	Q VMU-A M12x175	INDOOR	464	QS-221	M12 x 30	OUTDOOR	473
			QS-277	Q VMU-A M12x175 A4	OUTDOOR	464	+ QS-217	Für M12	OUTDOOR	473
			QS-559	Q VMZ-IG 105 M12 A4	OUTDOOR	465	QS-225	M12 x 45	OUTDOOR	473
							+ QS-215	Für M12	OUTDOOR	473
 MOD 6100 / 6200	8 / 8		FÜR BETON				FÜR HOLZ			
			QS-207	Q VMZ-IG 90 M12 A4	OUTDOOR		465	QS-250	10 x 80	INDOOR
			+ QS-74	M12 x 40	OUTDOOR	472	QS-251	10 x 120	INDOOR	469
			QS-36	Q SZ-SK 12/50	INDOOR	467				
			QS-519	Q SZ-SK 12/50 A4	OUTDOOR	467				









EASY GLASS® FRANZÖSISCHE BALKONE - EASY GLASS® VIEW

Montage	t (mm)	Anker	QS	Typ	Verwendung	Schraube / Bolzen	QS	Typ	Verwendung		
 MOD 6839 / 6830 MOD 6849	4,5	 Chemisch	FÜR BETON		OUTDOOR		FÜR STAHL				
			QS-529	Q VMZ-IG 75 M8			465	QS-27	M8 x 20	OUTDOOR	472
			+ QS-27	M8 x 20			472	QS-30	M8 x 35	OUTDOOR	472
					+ QS-287	Für M8	473				
		 Mechanisch	Andere		OUTDOOR		FÜR HOLZ				
			QS-266	5,5 x 50			469	QS-264	6 x 80	OUTDOOR	469
			QS-579	M16 x 65	469						

EASY GLASS® FRANZÖSISCHE BALKONE - MOD 6507-6508













Montage	t (mm)	Anker	QS	Typ	Verwendung	Schraube / Bolzen	QS	Typ	Verwendung	
 MOD 6507 / 6508	4	 Chemisch	FÜR BETON		OUTDOOR		FÜR STAHL			
			QS-64	Q VMZ-A 60 M10-10/85 A4			464	QS-72	M10 x 45	OUTDOOR
					QS-273	Q VMU-A M10x130 A4	464			
		 Mechanisch			OUTDOOR					
QS-58	Q BZ 10 10-30/90 A4		467							

EASY GLASS® FRANZÖSISCHE BALKONE MIT GLASADAPTERN







Montage	t (mm)	Anker	QS	Typ	Verwendung	Schraube / Bolzen	QS	Typ	Verwendung		
 MOD 0749	5,5	 Chemisch	FÜR BETON		OUTDOOR		FÜR STAHL				
			QS-520	Q VMZ-IG 80 M10 A4			465	QS-533	M10 x 30	OUTDOOR	472
			+ QS-533	M10 x 30mm			472	QS-530	M10 x 35	OUTDOOR	472
 MOD 0763	9	 Chemisch	FÜR BETON		OUTDOOR		FÜR STAHL				
			QS-277	Q VMU-A M12x175 A4			464	QS-221	M12 x 30	OUTDOOR	473
					QS-60	Q VMU-A M12x175 A4	464	+ QS-217	Für M12	OUTDOOR	473
		 Mechanisch			OUTDOOR						
			QS-560	Q SZ 12/10 A4			467				
			QS-34*	Q BZ 8 10-21/75 A4	467						

*Optional



ABSTURZSTANGEN

Montage	t (mm)	Anker	QS	Typ	Verwendung	Schraube / Bolzen	QS	Typ	Verwendung		
 MOD 4828	7	 Chemisch	FÜR BETON		OUTDOOR		FÜR STAHL				
			QS-529	Q VMZ-IG 75 M8			465	QS-20	M8 x 25	OUTDOOR	472
								Andere			
			QS-579	M16 x 65	469						
 MOD 0842 MOD 0843	14,5	 Chemisch	FÜR BETON		OUTDOOR		FÜR STAHL				
			QS-529	Q VMZ-IG 75 M8			465	QS-22	M8 x 40	OUTDOOR	472
								Andere			
			QS-579	M16 x 65	469						
 MOD 6517	4	 Chemisch	FÜR BETON		OUTDOOR		FÜR STAHL				
			QS-529	Q VMZ-IG 75 M8			465	QS-27	M8 x 20	OUTDOOR	472
								Andere			
			QS-579	M16 x 65	469						
 MOD 6518	4	 Chemisch	FÜR BETON		OUTDOOR		FÜR STAHL				
			QS-529	Q VMZ-IG 75 M8			465	QS-27	M8 x 20	OUTDOOR	472
								Andere			
			QS-579	M16 x 65	469						



EASY ALU

Montage	t (mm)	Anker	QS	Typ	Verwendung	Schraube/ Bolzen	QS	Typ	Verwendung				
Boden  MOD 9026	26	Chemisch	FÜR BETON					FÜR HOLZ					
			QS-284	Q VMU-A M12 x 265	INDOOR			464	QS-255	8 x 80	INDOOR	469	
			QS-285	Q VMU-A M12 x 265	OUTDOOR	464							
Seiten  MOD 9028-120-00  MOD 9028-120-90	8	Chemisch	FÜR BETON					FÜR HOLZ					
			QS-276	Q VMU-A M12x175	INDOOR			464	QS-255	8 x 80	INDOOR	469	
				QS-277	Q VMU-A M12x175 A4	OUTDOOR	464						
	20	Mechanisch											
				QS-574	Q BSZ SU 10x100	INDOOR			468				
				QS-575	Q BSZ SU 10x100 A4	OUTDOOR			468				
QS-576				Q BSZ SU 10x120	INDOOR	468							
			QS-577	Q BSZ SU 10x120 A4	OUTDOOR	468							

















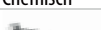







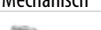

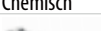

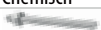
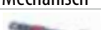

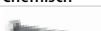
SQUARE LINE® 40x40

Für	t (mm)	Anker	QS	Typ	Verwendung			
Boden  MOD 4921 / 4972  MOD 4942 / 4940	8	Chemisch	FÜR BETON					
			QS-65	Q VMZ-A 60 M10-10/85	INDOOR		464	
			QS-64	Q VMZ-A 60 M10-10/85 A4	OUTDOOR	464		
		Mechanisch						
				QS-59	Q BZ 10 10-30/90	INDOOR		467
				QS-58	Q BZ 10 10-30/90 A4	OUTDOOR		467

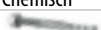
SQUARE LINE® 60x30

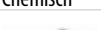
Für	t (mm)	Anker	QS	Typ	Verwendung	
Boden  MOD 4901 / 3503	11	Chemisch	FÜR BETON			
			QS-559	Q VMZ-IG 105 M12 A4	OUTDOOR	
		Mechanisch		QS-577	Q BSZ SU 10x120 A4	OUTDOOR
Seiten  MOD 4558	11	Chemisch	FÜR BETON			
			QS-63	Q VMZ-A 50 M8-15/80	INDOOR	
			QS-62	Q VMZ-A 50 M8-15/80 A4	OUTDOOR	464

Q-LINE

Montage	t (mm)	Anker	QS	Typ	Verwendung	Schraube / Bolzen	QS	Typ	Verwendung	
 MOD 3504	10	Chemisch	FÜR BETON							
			QS-273	Q VMU-A M10 x 130	OUTDOOR					464
		Mechanisch								
			QS-58	Q BZ 10 10-30/90	OUTDOOR					467
			QS-578	Q BSZ SU 8 x 70 A4	OUTDOOR	468				
 MOD 0948 MOD 0949	12							FÜR STAHL		
								QS-223	M12 x 30	OUTDOOR
							+ QS-217	Für M12	OUTDOOR	473
							QS-219	M12 x 35	OUTDOOR	473
							+ QS-217	Für M12	OUTDOOR	473
							QS-225	M12 x 40	OUTDOOR	473
							+ QS-217	Für M12	OUTDOOR	473
 MOD 0921 / 9921	8	Chemisch	FÜR BETON							
			QS-65	Q VMZ-A 60 M10-10/85	INDOOR					464
			QS-64	Q VMZ-A 60 M10-10/85 A4	OUTDOOR					464
		Mechanisch								
 MOD 0962 / 0940			QS-59	Q BZ 10 10-30/90	INDOOR	467				
			QS-58	Q BZ 10 10-30/90 A4	OUTDOOR	467				
 MOD 0912 / 3502	8	Chemisch	FÜR BETON							
			QS-63	VMZ-A 50 M8-15/80	INDOOR					464
			QS-62	Q VMZ-A 50 M8-15/80 A4	OUTDOOR					464
		Mechanisch								
			QS-35	Q BZ 8 10-21/75	INDOOR	467				
			QS-34	Q BZ 8 10-21/75 A4	OUTDOOR	467				
 MOD 0916 / 0917 / 3505	13,5	Chemisch	FÜR BETON							
			QS-272	Q VMU-A M10 x 130	INDOOR					464
			QS-273	Q VMU-A M10 x 130	OUTDOOR					464
 MOD 3508	10	Chemisch	FÜR BETON							
			QS-275	Q VMU-A M12 x 155	OUTDOOR					464
		Mechanisch								
			QS-560	Q SZ 12/10 A4	OUTDOOR					467
			QS-562	Q SZ 12/30 A4	OUTDOOR	467				
 MOD 0557	11	Chemisch	FÜR BETON							
			QS-33	Q VMZ-A 75 M12-25/120	INDOOR					464
			QS-32	Q VMZ-A 75 M12-25/120 A4	OUTDOOR					464
 MOD 0555 0551 / 0552										
 MOD 0558	10,5	Chemisch	FÜR BETON							
			QS-33	Q VMZ-A 75 M12-25/120	INDOOR					464
			QS-275	Q VMU-A M12x155	OUTDOOR					464
 MOD 0556	20	Chemisch	FÜR BETON							
			QS-505	Q VMZ-IG 105 M12	INDOOR					465
			+ QS-551	M12 x 40	INDOOR					472
			+ QS-217	Für M12	INDOOR					473
								FÜR STAHL		
						QS-551		M12 x 40	INDOOR	472



MOD 4410

Stahl, verzinkt

INDOOR	QS	Typ	d		L	
254410-811	QS-270	QVMU-A M8x110	M8	Ø 10	110	10
254410-820	QS-281	QVMU-A M8x205	M8	Ø 10	205	10
254410-113	QS-272	QVMU-A M10x130	M10	Ø 12	130	10
254410-215	QS-274	QVMU-A M12x155	M12	Ø 14	155	10
254410-217	QS-276	QVMU-A M12x175	M12	Ø 14	175	10
254410-226	QS-284	QVMU-A M12x265	M12	Ø 14	265	10

V4A 316

OUTDOOR

244410-811	QS-271	QVMU-A M8x110	M8	Ø 10	110	10
244410-820	QS-282	QVMU-A M8x205	M8	Ø 10	205	10
244410-113	QS-273	QVMU-A M10x130	M10	Ø 12	130	10
244410-215	QS-275	QVMU-A M12x155	M12	Ø 14	155	10
244410-217	QS-277	QVMU-A M12x175	M12	Ø 14	175	10
244410-226	QS-285	QVMU-A M12x265	M12	Ø 14	265	10

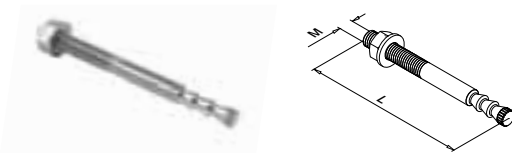

MOD 4010

Stahl, verzinkt

INDOOR	QS	Typ		L	
254010-880	QS-63	QVMZ-A 50 M8-15/80	Ø 10	80	10
254010-185	QS-65	QVMZ-A 60 M10-10/85	Ø 12	85	10
254010-212	QS-33	QVMZ-A 75 M12-25/120	Ø 14	120	10
254010-217	QS-507	QVMZ-A 125 M12-25/170	Ø 14	170	10

V4A 316

OUTDOOR

244010-880	QS-62	QVMZ-A 50 M8-15/80 A4	Ø 10	80	10
244010-185	QS-64	QVMZ-A 60 M10-10/85 A4	Ø 12	85	10
244010-212	QS-32	QVMZ-A 75 M12-25/120 A4	Ø 14	120	10
244010-213	QS-549	QVMZ-A 75 M12-40/135 A4	Ø 14	135	10
244010-217	QS-60	QVMZ-A 125 M12-25/170 A4	Ø 14	170	10



Q-INFO MOD 4410

Montage-Informationen Q-Anker VMU-A

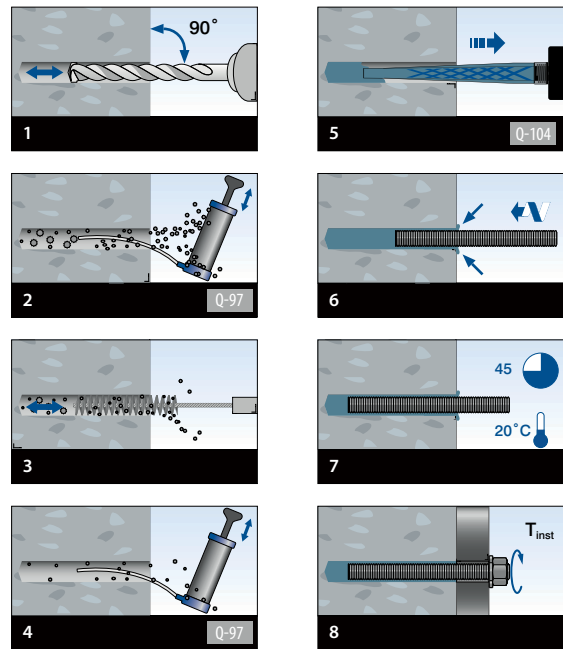

Q-INFO MOD 4010

Montage-Informationen Q-Anker VMZ-A

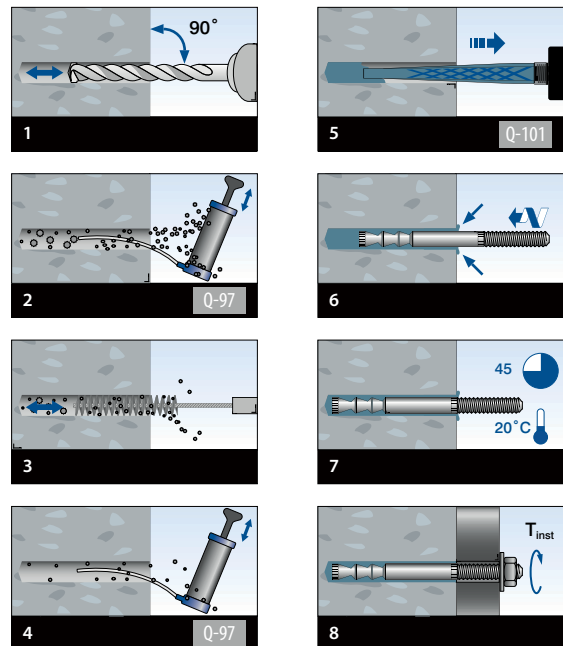

Chemische Betonanker



MOD 4510

Stahl, verzinkt

INDOOR	QS	Typ	d		L	
254510-875	QS-528	QVMZ-IG 75 M8	M8	Ø 12	78	10
254510-180	QS-521	QVMZ-IG 80 M10	M10	Ø 14	84	10
254510-290	QS-208	QVMZ-IG 90 M12	M12	Ø 18	94	10
254510-210	QS-505	QVMZ-IG 105 M12	M12	Ø 18	109	10
254510-212	QS-212	QVMZ-IG 125 M12	M12	Ø 18	130	10

V4A 316

OUTDOOR

244510-875	QS-529	QVMZ-IG 75 M8	M8	Ø 12	78	10
244510-180	QS-520	QVMZ-IG 80 M10 A4	M10	Ø 14	84	10
244510-290	QS-207	QVMZ-IG 90 M12 A4	M12	Ø 18	94	10
244510-212	QS-211	QVMZ-IG 125 M12 A4	M12	Ø 18	130	10

Q-INFO MOD 4510

Montage-Informationen Q-Anker VMZ-IG

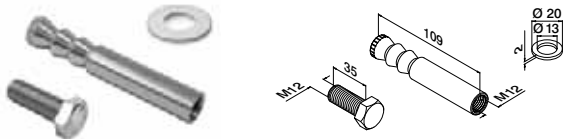
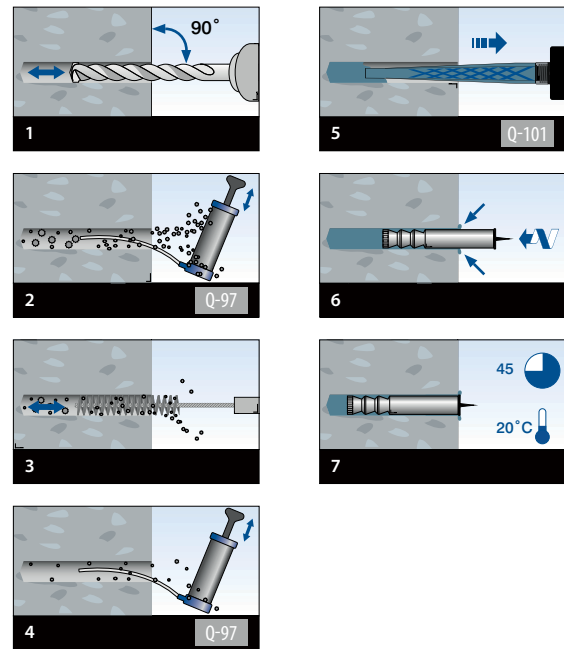

MOD 4519

V4A 316

OUTDOOR

244519-210	QS-559	QVMZ-IG 105 M12 A4	Ø 18	10
------------	--------	--------------------	------	----

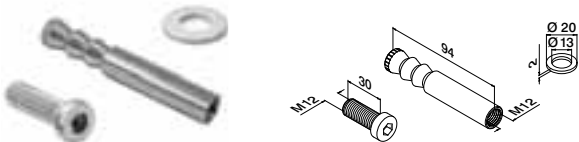

MOD 4519

Stahl, verzinkt

INDOOR	QS	Typ		
254519-290	QS-558	QVMZ-IG 90 M12	Ø 18	10

V4A 316

OUTDOOR

244519-290	QS-557	QVMZ-IG 90 M12 A4	Ø 18	10
------------	--------	-------------------	------	----



Q-INFO MOD 4519

Montage-Informationen Q-Anker VMZ-IG

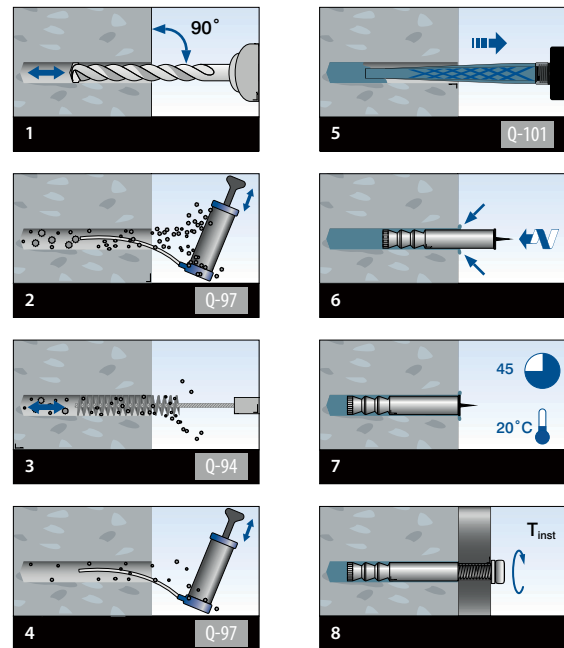

Zubehör für chemische Betonanker



Injektionsmörtel

MOD 4089 / 4090

Zubehör				
	Q	e		
204089-28	Q-104	280 ml	Q-VMU-A	1
NEW 204089-30	Q-104	300 ml	Q-VMU-A	1
204090-28	Q-101	280 ml	Q-VMZ	1
NEW 204090-30	Q-101	300 ml	Q-VMZ	1



Ausbläser für Bohrlöcher

MOD 4092

Zubehör		
	Q	
204092	Q-97	1



Reinigungsbürste für Bohrlöcher

MOD 4093

Zubehör			
	Q		
204093-010	Q-91	Ø 10	1
204093-012	Q-92	Ø 12	1
204093-014	Q-93	Ø 14	1
204093-018	Q-94	Ø 18	1
204093-020	Q-95	Ø 20	1



Statikmischer für Injektionsmörtel

MOD 4091

Zubehör		
	Q	
204091	Q-103	1



Verlängerung für Reinigungsbürste mit M6 Anschlussgewinde, 150 mm

MOD 4094

Zubehör		
	Q	
204094	Q-89	1



Verlängerung für Statikmischer für Injektionsmörtel VMZ 280/300, 200 mm

MOD 4096

Zubehör		
	Q	
204096	Q-88	1



Auspresspistole für Injektionsmörtel

MOD 4095

Zubehör		
	Q	
204095	Q-102	1

Q-INFO | MOD 4089 / 4090

Anzahl Bohrlochfüllungen pro Injektionskartusche

VMZ-A	QS-32	QS-33	QS-60	QS-62	QS-63	QS-64	QS-65	QS-507	QS-549
Q-101 (280 ml)	34	34	24	58	58	39	39	24	34
Q-101 (300 ml)	36	36	25	62	62	41	41	25	36

VMZ-IG	QS-207	QS-208	QS-211	QS-212	QS-505	QS-520	QS-521	QS-528	QS-557	QS-558	QS-559
Q-101 (280 ml)	21	21	16	16	19	27	27	34	21	21	19
Q-101 (300 ml)	22	22	17	17	20	29	29	36	22	22	20

VMU-A	QS-270	QS-271	QS-281	QS-282	QS-272	QS-273	QS-274	QS-275	QS-276	QS-277	QS-284	QS-285
Q-104 (280 ml)	46	46	40	40	32	32	22	22	22	22	19	19
Q-104 (300 ml)	50	50	42	42	34	34	23	23	23	23	20	20



Q-101 / Q-104
280 ml
204090-28
204089-28

Q-101 / Q-104
300 ml
204090-30
204089-30

Mechanische Betonanker



MOD 4110

Stahl, verzinkt

INDOOR	QS	Typ	d		L	
254110-875	QS-35	Q BZ 8 10-21/75	M8	Ø 8	75	10
254110-190	QS-59	Q BZ 10 10-30/90	M10	Ø 10	90	10

V4A 316

OUTDOOR

244110-875	QS-34	Q BZ 8 10-21/75 A4	M8	Ø 8	75	10
244110-190	QS-58	Q BZ 10 10-30/90 A4	M10	Ø 10	90	10



Q-INFO MOD 4110

Montage-Informationen Q-Anker BZ Plus 8 & BZ Plus 10

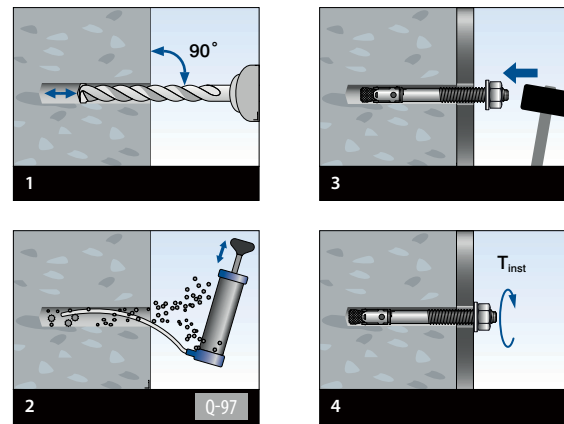

MOD 4210

Stahl, verzinkt

INDOOR	QS	Typ	Ø		L	
254210-212	QS-36	Q SZ-SK 12/50	12	Ø 12	120	25

V4A 316

OUTDOOR

244210-212	QS-519	Q SZ-SK 12/50 A4	12	Ø 12	120	25
------------	--------	------------------	----	------	-----	----



Q-INFO MOD 4210

Montage-Informationen Q-Anker SZ-SK 12/50

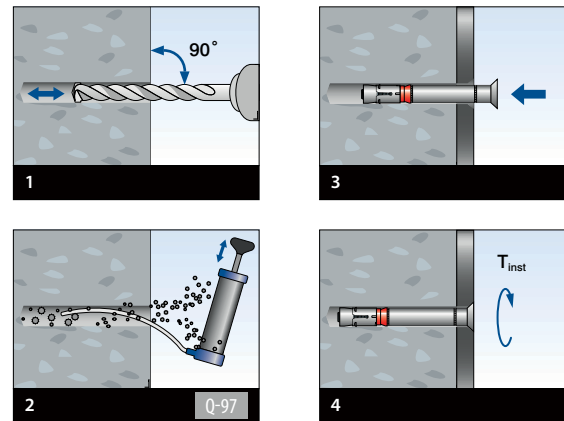

MOD 4220

Stahl, verzinkt

INDOOR	QS	Typ	Ø		L	
254220-285	QS-561	Q SZ-S 12/10	12	Ø 12	85	25
254220-211	QS-563	Q SZ-S 12/30	12	Ø 12	105	25

V4A 316

OUTDOOR

244220-285	QS-560	Q SZ-S 12/10 A4	12	Ø 12	85	25
244220-211	QS-562	Q SZ-S 12/30 A4	12	Ø 12	105	25



Q-INFO MOD 4220

Montage-Informationen Q-Anker SZ-S 12/10-30

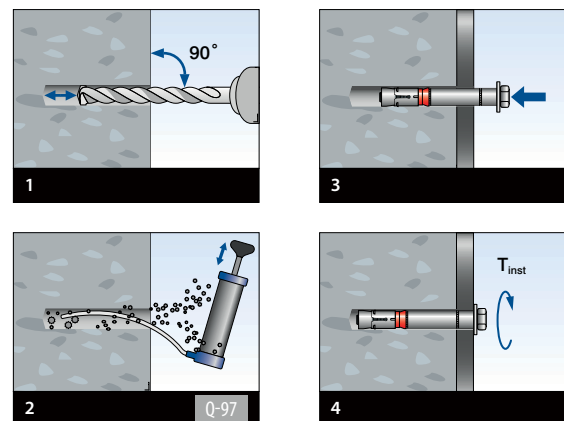

Betonschrauben



MOD 4310

Stahl, verzinkt

INDOOR	QS	Typ	Ø	L	50	
254310-110	QS-574	Q BSZ SU 10x100	10	Ø 10	100	50
254310-112	QS-576	Q BSZ SU 10x120	10	Ø 10	120	50

V4A 316

OUTDOOR

244310-110	QS-575	Q BSZ SU 10x100 A4	10	Ø 10	100	50
244310-112	QS-577	Q BSZ SU 10x120 A4	10	Ø 10	120	50
NEW 244310-870	QS-578	Q-BSZ SU 8x70 A4	8	Ø 8	70	50



MOD 4300

Stahl, verzinkt

INDOOR	QS	Typ	Q	Ø	L	50	
254300-110	QS-571	Q BSZ SK 10x100	114	10	Ø 10	100	50

V4A 316

OUTDOOR

244300-110	QS-572	Q BSZ SK 10x100 A4	114	10	Ø 10	100	50
244300-112	QS-573	Q BSZ SK 10x120 A4	114	10 <td>Ø 10</td> <td>120</td> <td>50</td>	Ø 10	120	50



MOD 0665

V4A 316

OUTDOOR

240665-232	QS-286	Für d	25
		M12	25

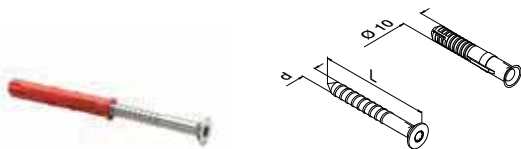

MOD 4250

V4A 316

OUTDOOR

244250-180	QS-214	d	Ø 10	L	80	50
		7	Ø 10	80	50	



Q-INFO MOD 4310

Montage-Informationen Q-Anker Q BSZ SU 10x100 + 10x120 (A4)

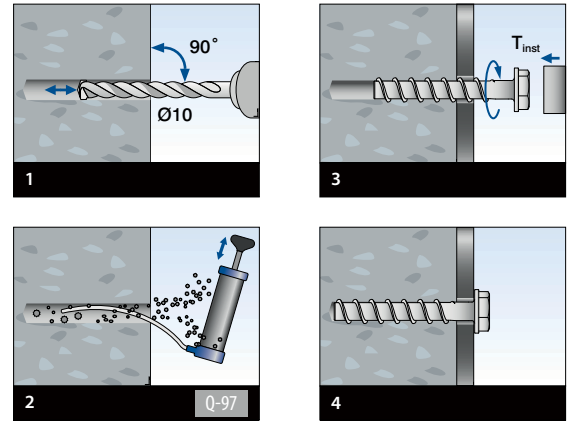

Q-INFO MOD 4300

Montage-Informationen Q-Anker Q BSZ SK 10x100 + 10x120 (A4)

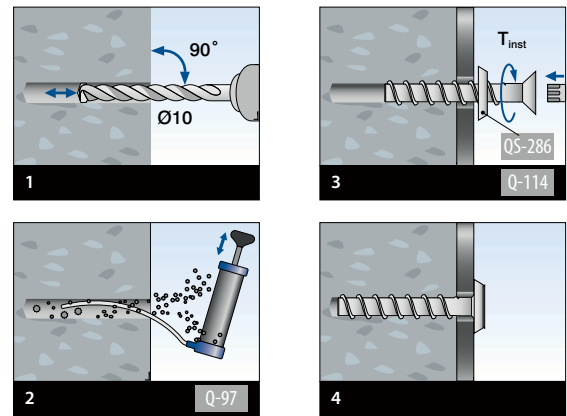

MOD 4260

V4A 316

OUTDOOR

244260-180	QS-213	d	Ø 10	L	80	50
		7	Ø 10	80	50	



Schrauben

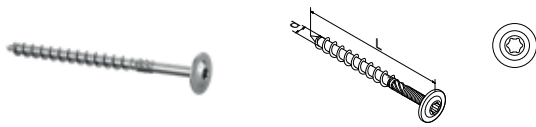

MOD 0250

Stahl, verzinkt

INDOOR	QS	Q	d	L	☐
250250-808	QS-255	Q-113	8	80	50
250250-812	QS-256	Q-113	8	120	50
250250-012	QS-258	Q-114	10	120	50

V2A 304

INDOOR

230250-608	QS-264	Q-115	6	80	50
230250-610	QS-265	Q-115	6	100	50



Q-INFO MOD 0250

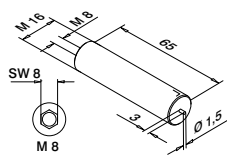
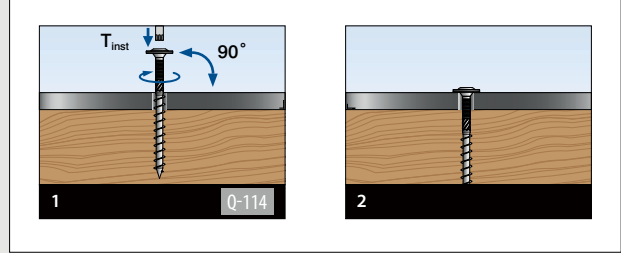

MOD 0805

V4A 316

OUTDOOR

OUTDOOR	QS	Q	d	Ø	L	☐
230805-665	QS-579	Q-8	M8	M16	65	2



Q-INFO MOD 0805

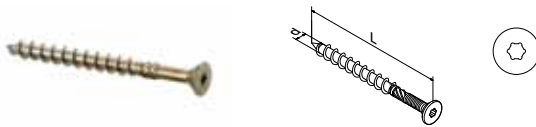
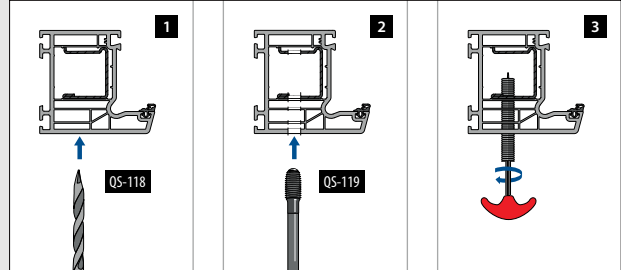

MOD 0260

Stahl, verzinkt

INDOOR	QS	Q	d	L	☐
250260-008	QS-250	Q-113	10	80	50
250260-012	QS-251	Q-113	10	120	50



MOD 0251

Stahl, verzinkt C4

OUTDOOR	QS	d	L	☐
250251-010	QS-290	10	100	25



MOD 0915

V4A 316

OUTDOOR

OUTDOOR	QS	☐
240915-550	QS-266	50



Bit 1/4", 5/16" Antrieb

MOD 1016

Zubehör

Zubehör	Q	☐	AW	L	☐
201016-230	Q-115	1/4"	30	25	1
201016-240	Q-113	1/4"	40	26	1
201016-550	Q-114	5/16"	50	50	1

Q-INFO MOD 0915

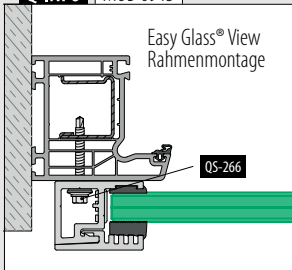

Q-INFO MOD 0805

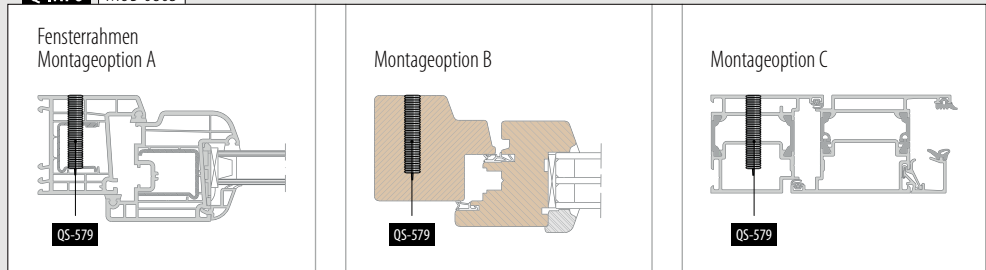

Dübel



MOD 0841

Zubehör		QS	Ø	L	
200841-635	QS-87	6	35	100	
200841-160	QS-555	10	60	50	

SELL OUT



MOD 0843

Stahl, verzinkt		QS	Für	
IN/OUTDOOR				
200843-008	QS-570	M8	25	



MOD 0491 - DIN 914 / ISO 4027

V2A	304	QS	Q	d	L	
INDOOR						
230491-850	QS-288	4	M8	50	50	



MOD 0851

Messing		QS	
IN/OUTDOOR			
200851-827	QS-55	50	

Q-INFO | MOD 0841

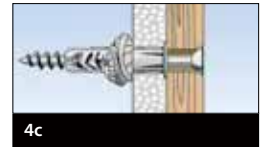

Q-INFO | MOD 0843 / 0491

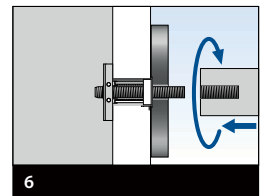
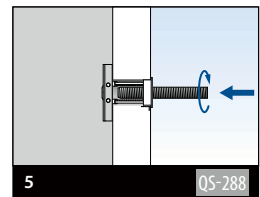
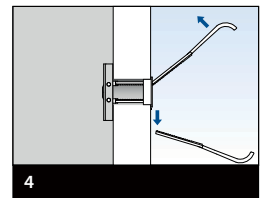
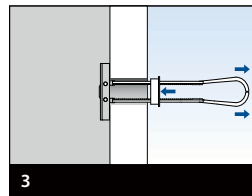
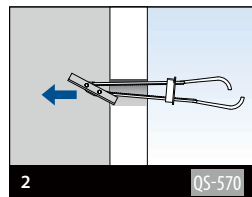
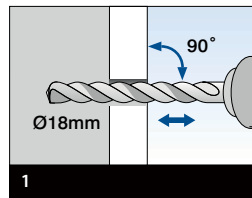

Q-INFO | MOD 0851

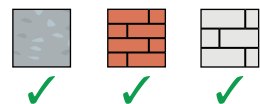
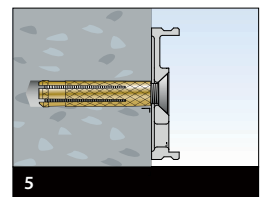
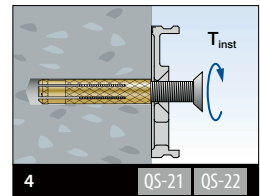
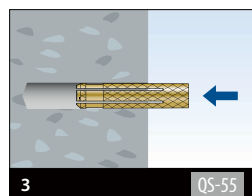
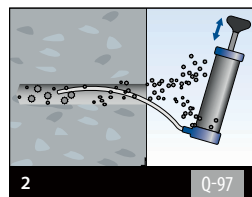
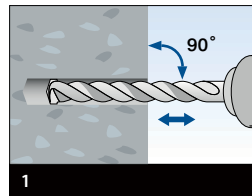

Schrauben

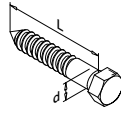

MOD 0200 - DIN 571

V2A	304				
INDOOR		QS	d	L	
230200-760	QS-3	7	60	50	
V4A	316	OUTDOOR			
240200-760	QS-4	7	60	50	
240200-890	QS-556	8	90	50	

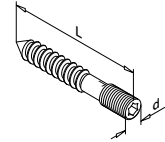

MOD 0205

V2A	304					
INDOOR		QS	Q	d	L	
230205-050	QS-1	Q-4	M8 x 12	50	50	
230205-090	QS-85	Q-4	M8 x 33	90	50	
V4A	316	OUTDOOR				
240205-050	QS-2	Q-4	M8 x 12	50	50	
240205-090	QS-86	Q-4	M8 x 33	90	50	

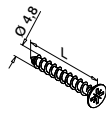

MOD 0210 - DIN 7982 C-H

V2A	304			
INDOOR		QS	L	
230210-025	QS-5	25	50	
230210-038	QS-7	38	50	
230210-060	QS-503	60	50	
V4A	316	OUTDOOR		
240210-025	QS-6	25	50	
240210-038	QS-50	38	50	
SELL OUT	240210-060	QS-504	60	50

SELL OUT

MOD 0240

V2A	304			
INDOOR		QS	L	
230240-412	QS-200	12	50	

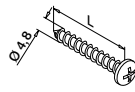

MOD 0230 - DIN 7981 C-H

V2A	304			
INDOOR		QS	L	
230230-025	QS-8	25	50	
230230-038	QS-56	38	50	
V4A	316	OUTDOOR		
240230-025	QS-9	25	50	
240230-038	QS-57	38	50	

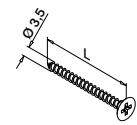

MOD 0211 - DIN 7997

V2A	304			
INDOOR		QS	L	
230211-340	QS-49	40	50	

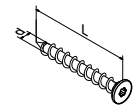

MOD 0212 - ISO 14586

V4A	316				
OUTDOOR		QS	d	L	
240212-413	QS-268	4,2	13	50	
240212-438	QS-267	4,2	38	50	



Schrauben

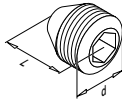

MOD 0400 - DIN 916 / ISO 4029

V2A	304						
		INDOOR	QS	Q	d	L	☐
		230400-505	QS-91	Q-2,5	M5	5	50

V4A	316						
		OUTDOOR					
		240400-505	QS-90	Q-2,5	M5	5	50
		240400-610	QS-92	Q-3	M6	10	50

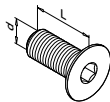

MOD 0670 - DIN 7991

V2A	304						
		INDOOR	QS	Q	d	L	☐
		230670-520	QS-12	Q-3	M5	20	50
		230670-612	QS-48	Q-4	M6	12	50
		230670-620	QS-14	Q-4	M6	20	50
		230670-625	QS-15	Q-4	M6	25	50
		230670-630	QS-17	Q-4	M6	30	50
		230670-825	QS-19	Q-5	M8	25	50
		230670-840	QS-21	Q-5	M8	40	50
		230670-130	QS-532	Q-6	M10	30	50
		230670-135	QS-531	Q-6	M10	35	50

V4A	316						
		OUTDOOR					
		240670-520	QS-13	Q-3	M5	20	50
		240670-608	QS-205	Q-4	M6	8	50
		240670-612	QS-89	Q-4	M6	12	50
		240670-625	QS-16	Q-4	M6	25	50
		240670-630	QS-18	Q-4	M6	30	50
		240670-825	QS-20	Q-5	M8	25	50
		240670-840	QS-22	Q-5	M8	40	50
		240670-130	QS-533	Q-6	M10	30	50
		240670-135	QS-530	Q-6	M10	35	50
		240670-240	QS-74	Q-8	M12	40	50

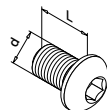

MOD 0690 - ISO 7380

V2A	304						
		INDOOR	QS	Q	d	L	☐
		230690-510	QS-202	Q-3	M5	10	50
		230690-516	QS-10	Q-3	M5	16	50
		230690-616	QS-83	Q-4	M6	16	50

V4A	316						
		OUTDOOR					
		240690-510	QS-203	Q-3	M5	10	50
		240690-516	QS-11	Q-3	M5	16	50
		240690-608	QS-261	Q-4	M6	8	50
		240690-616	QS-84	Q-4	M6	16	50

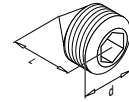

MOD 0490 - DIN 914 / ISO 4027

V2A	304						
		INDOOR	QS	Q	d	L	☐
		230490-506	QS-94	Q-2,5	M5	6	50

V4A	316						
		OUTDOOR					
		240490-506	QS-93	Q-2,5	M5	6	50

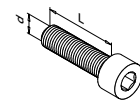

MOD 0680 - DIN 912 / ISO 4762

Stahl, verzinkt

		INDOOR	QS	Q	d	L	☐
		250680-820	QS-28	Q-6	M8	20	50

V2A	304						
		INDOOR	QS	Q	d	L	☐
		230680-620	QS-23	Q-5	M6	20	50
		230680-635	QS-24	Q-5	M6	35	50
		230680-645	QS-54	Q-5	M6	45	50
		230680-660	QS-25	Q-5	M6	60	50
		230680-820	QS-26	Q-6	M8	20	50
		230680-835	QS-29	Q-6	M8	35	50
		230680-140	QS-67	Q-8	M10	40	50
		230680-240	QS-551	-	M12	40	50

V4A	316						
		OUTDOOR					
		240680-620	QS-53	Q-5	M6	20	50
		240680-645	QS-70	Q-5	M6	45	50
		240680-660	QS-71	Q-5	M6	60	50
		240680-820	QS-27	Q-6	M8	20	50
		240680-835	QS-30	Q-6	M8	35	50
		240680-140	QS-72	Q-8	M10	45	50

SELB
OUT

Bolzen

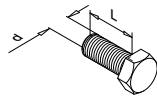

MOD 0661 - DIN 933

Stahl, verzinkt

INDOOR	QS	d	L	
250661-230	QS-224	M12	30	50

V4A 316

OUTDOOR

240661-230	QS-223	M12	30	50
240661-235	QS-219	M12	35	50
240661-245	QS-225	M12	45	50

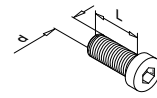

MOD 0662 - DIN 7984

Stahl, verzinkt

INDOOR	QS	Q	d	L	
250662-230	QS-222	Q-8	M12	30	50

V4A 316

OUTDOOR

240662-230	QS-221	Q-8	M12	30	50
------------	--------	-----	-----	----	----



Unterlegscheiben

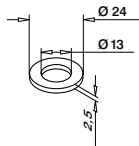

MOD 0663 - DIN 125A / ISO 7089

Stahl, verzinkt

INDOOR	QS	Für d	
250663-224	QS-216	M12	50

V4A 316

OUTDOOR

240663-224	QS-215	M12	50
------------	--------	-----	----

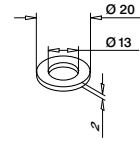

MOD 0664 - DIN 433 / ISO 7092

V4A 316

OUTDOOR	QS	Für d	
240664-220	QS-217	M12	50

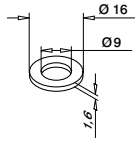

MOD 0666 - DIN 125A / ISO 7089

V4A 316

OUTDOOR

OUTDOOR	QS	Für d	
240666-816	QS-287	M8	50

(Hut-)Muttern

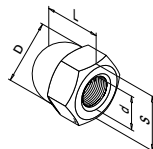

MOD 0650 - DIN 1587

V2A 304

INDOOR	QS	S	d	D	L	
230650-865	QS-514	13	M8	12,5	15	50
230650-108	QS-517	17	M10	16	18	50
230650-210	QS-518	19	M12	18	22	50

V4A 316

OUTDOOR

240650-865	QS-513	13	M8	12,5	15	50
240650-108	QS-515	17	M10	16	18	50
240650-210	QS-516	19	M12	18	22	50

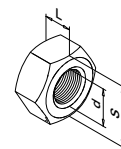

MOD 0651 - DIN 934

V4A 316

OUTDOOR	QS	S	d	L	
240651-208	QS-289	19	M12	10	50

SELL
OUT

Befestigungsmaterial für Glasklemmen

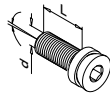

Justierbare Schraube
+/- 5°

MOD 0681

Für alle Modelle in Zinkdruckguss

Stahl, verzinkt						
INDOOR	QS	Q	d	L		
250681	QS-46	Q-5	M8	20	50	

Für alle Modelle in V2A

V2A	304					
INDOOR	QS	Q	d	L		
230681	QS-47	Q-5	M8	20	50	

Für alle Modelle in V4A

V4A	316					
OUTDOOR	QS	Q	d	L		
240681	QS-45	Q-5	M8	20	50	

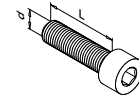

Zylinderschraube mit Innensechskant

MOD 0680 - DIN 912 / ISO 4762

Für alle Modelle in Zinkdruckguss

Stahl, verzinkt						
INDOOR	QS	Q	d	L		
250680-820	QS-28	Q-6	M8	20	50	

Für alle Modelle in V2A

V2A	304					
INDOOR	QS	Q	d	L		
230680-820	QS-26	Q-6	M8	20	50	

Für alle Modelle in V4A

V4A	316					
OUTDOOR	QS	Q	d	L		
240680-820	QS-27	Q-6	M8	20	50	

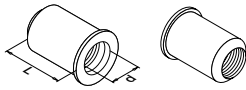

Blindnietmutter mit Flachkopf

MOD 0800

V2A	304						
INDOOR	QS	Q	d	L			
230800-616	QS-38	Q-29	M6	Ø 9,0	16	50	
230800-817	QS-39	Q-29	M8	Ø 11,0	17	50	
230800-121	QS-40	Q-29	M10	Ø 12,0	21	50	

V4A	316						
OUTDOOR	QS	Q	d	L			
240800-616	QS-80	Q-29	M6	Ø 9,0	16	50	
240800-817	QS-81	Q-29	M8	Ø 11,0	17	50	
240800-121	QS-82	Q-29	M10	Ø 12,0	21	50	

SELL OUT

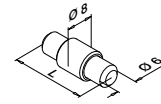

Sicherungsstifte für Glasklemmen und Blechadapter

MOD 5015

Zubehör	Für MOD	L	
205015-22	2800, 4200	22	4
205015-25	2500, 2600	25	4
205015-24	2400, 6000	30	4
205015-23	2300	34	4

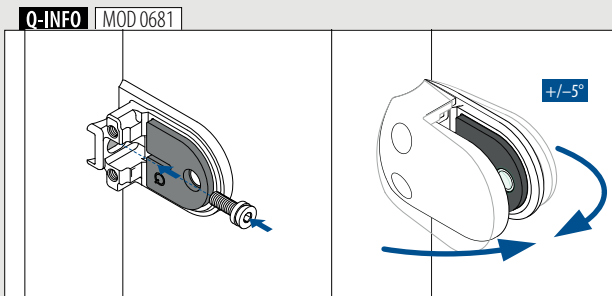
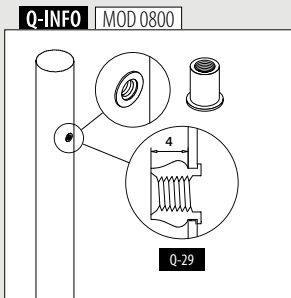

SELL OUT Nur solange der Vorrat reicht.

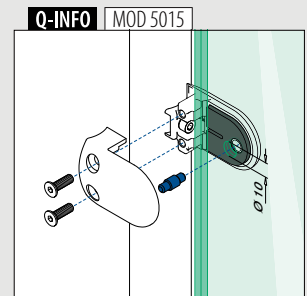
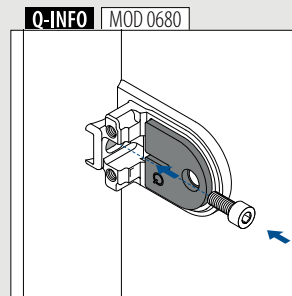

Ersatzmaterial für Glasklemmen

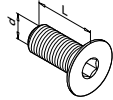

Senkkopfschraube mit Innensechskant

MOD 0670 - DIN 7991

Für MOD 2100, 2500, 2700, 2800, 4200, 4400, 4600 in Zinkdruckguss

Stahl, verzinkt					
INDOOR	QS	Q	d	L	
250670-616	QS-43	Q-4	M6	16	50

Für MOD 2400 in Zinkdruckguss

Stahl, verzinkt					
INDOOR	QS	Q	d	L	
250670-620	QS-44	Q-4	M6	20	50

Für MOD 2100, 2500, 2700, 2800, 4200, 4400, 4600, 5100, 5200 in V2A und V4A

V4A 316					
OUTDOOR	QS	Q	d	L	
240670-616	QS-41	Q-4	M6	16	50

Für MOD 2300, 2400, 2600 in V2A und V4A

V4A 316					
OUTDOOR	QS	Q	d	L	
240670-620	QS-42	Q-4	M6	20	50



Kunststoff-Abdeckkappen für seitliche Schrauben (2 Stück pro Glasklemme)

MOD 5010

Zubehör		Farbe	Für MOD	
205010-00-00		Roh (grau)	2100, 2300, 2400, 2500, 2600, 2700, 4200, 4400, 4600, 5100, 5200	8
205010-00-17		Glanzverchromt		8
205010-00-19		Edelstahleffekt		8
205010-00-31		Schwarz RAL 9005		8
205010-00-32		Weiss RAL 9016		8
205010-00-33		Anthrazitgrau RAL 7016		8
205010-28-00		Roh (grau)	2800	8
205010-28-17		Glanzverchromt		8
205010-28-19		Edelstahleffekt		8
205010-28-31		Schwarz RAL 9005		8

Einlagen für Glasadapter

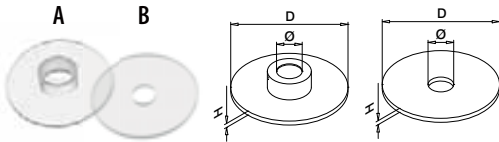

MOD 5031 / 5032 / 5034 / 5035 / 5039 / 5038 / 5030

Zubehör		Für MOD	D	Ø	H	Stück pro Glasadapter	
205032-47	A	0747 + 0750 + 0751 (Ø 50mm)	48	10	2	1	8
205031-47	B		1	8			
205034-030	A	0746 + 0740 + 0754 (Ø 30 mm)	28	8	2	2	8
205034-025	A	0755 (Ø 25 mm)	24	6	1	1	8
205035	B		1	8			
205034-050	A	0148 + 0117 + 9350 (Ø 50 mm)	48	8	2	2	8
205039	A	0752 + 0753	38	8	2	1	8
205038	B		1	8			
NEW 205030-150-01-03	A	0749	45	19	3	1	8
NEW 205030-150-02-03	B		46	13	3	1	8

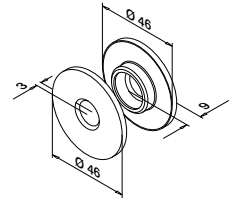

MOD 5030

Zubehör		Für MOD	
205030-150-99-80		0749	4

NEW

Q-INFO MOD 0670

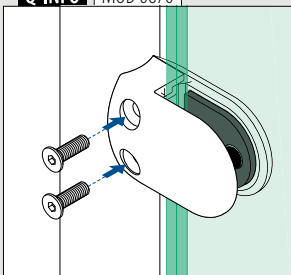

Bohren und Gewindeschneiden



14-teiliges Bohrer- und Gewindeschneideset für Edelstahl

MOD 1025

Zubehör			
	Q	M	
201025	Q-61	M3 - M12	1



Bohrschablone

MOD 1020

Zubehör				
	Q	Für Rohr Ø	M	
201020-042	Q-74	42,4	M5, M6, M8, M10	1
201020-048	Q-75	48,3	M5, M6, M8, M10	1



Gewindeschneider für MOD 0805

MOD 1029

Zubehör		
	Q	
201029	Q-119	1

NEW



Bohrer für MOD 0805

MOD 1028

Zubehör		
	Q	
201028	Q-118	1

NEW

Komplettes Set



Bohrschablone, 2-fach mit Führung

MOD 1021

Zubehör				
	Q	Für Rohr Ø	M	
201021-042	Q-76	42,4	M5, M6, M8, M10	1
201021-048	Q-77	48,3	M5, M6, M8, M10	1

SELL OUT



Bohr- und Schneidöl
Konzentriert, ohne Treibgas

MOD 1027

Zubehör			
	Q	e	
201027	Q-64	300 ml	1

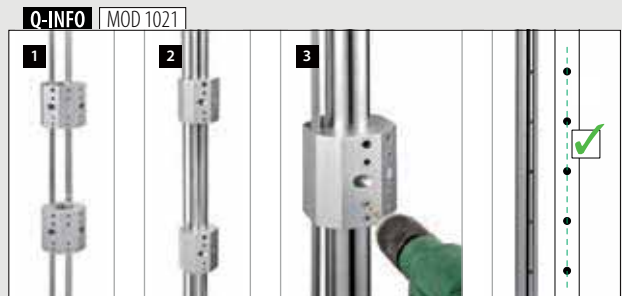

Nur solange der Vorrat reicht.

Bohren und Gewindeschneiden

Bohrschablone für Easy Alu Geländerpfosten

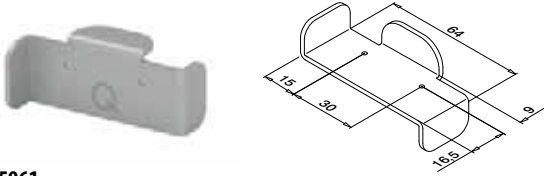

MOD 5961

Zubehör		
	Q	
205961	Q-85	1



Bohrschablone für Glas-Stopp

MOD 1041

Zubehör		
	Q	
201041	Q-117	1

NEW

Bohrschablonen für Glasleistenrohre, Set

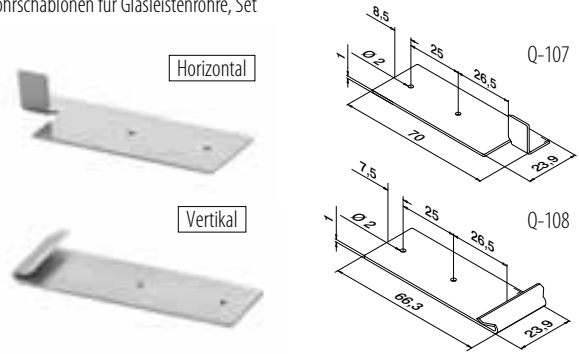

MOD 1022

Zubehör		
	Q	
201022	Q-107/Q-108	1

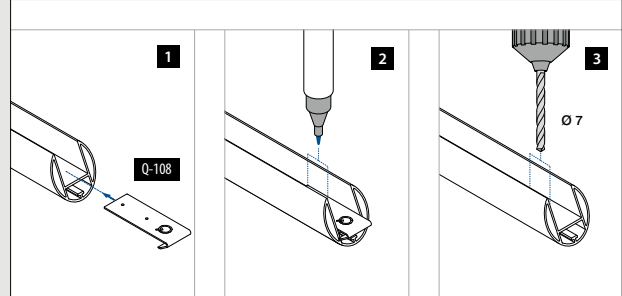
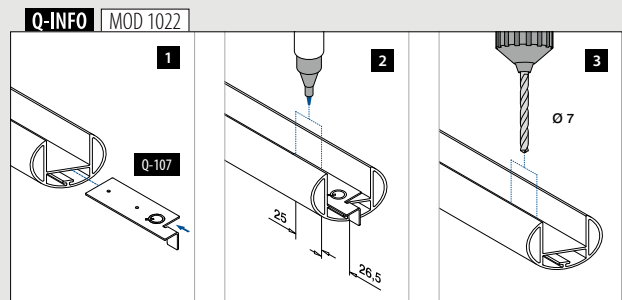
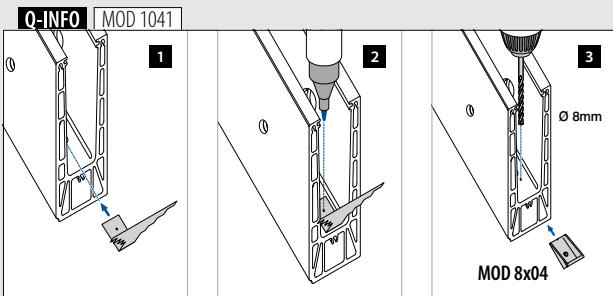
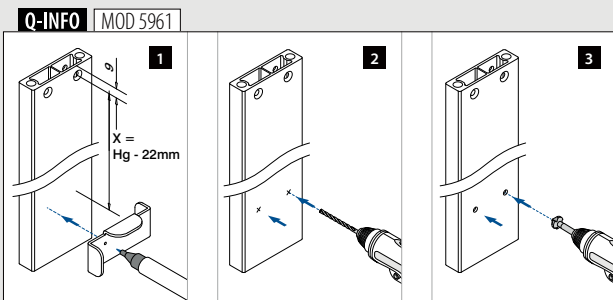

Q-82

Q-20

Bohrschablone



MOD 1023

Zubehör			
	Q	Für Ø	
201023	Q-82	42,0 + 48,0	1

MOD 1024

Zubehör			
	Q	Für Ø	
201024-042	Q-20	42,0	1



Holzleim

PVAC Leim zur Verbindung von Holzbauteilen

MOD 1335

Zubehör			
	Q	e	
201335	Q-73	250 ml	1

Verbindungsstifte

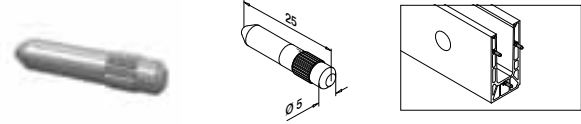

MOD 3005

V4A	316	Roh	
OUTDOOR			
143005			6



Bohrer mit Stopper für Holz

MOD 1026

Zubehör			
	Q	D	
201026	Q-80	15	1

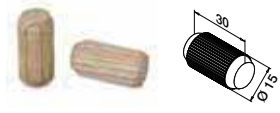

Dübel

MOD 0203

Holz		
INDOOR		
	QS	
200203	QS-512	50



MOD 0803 - DIN 7965

Stahl, verzinkt					
INDOOR					
	QS	d		L	
250803-120	QS-66	M10	Ø 17	20	50

V2A	304				
INDOOR					
	QS	d		L	
230803-818	QS-69	M8	Ø 14,5	18	50



Kabelbinder

MOD 1050

Zubehör			
	Q	L	
201050	Q-50	300	100

MONTAGEZUBEHÖR

ZUBEHÖR

Q-INFO | MOD 1024

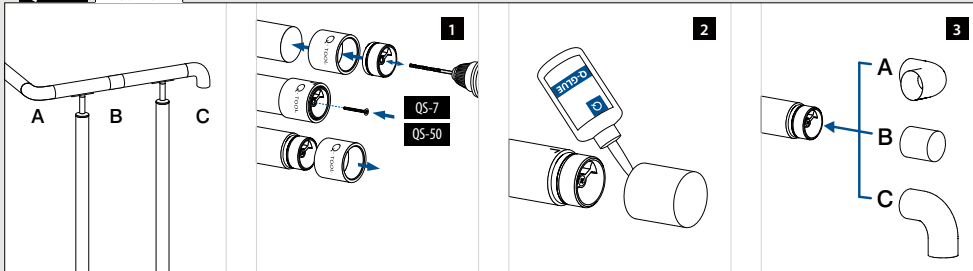

Q-INFO | MOD 1023 / 1024

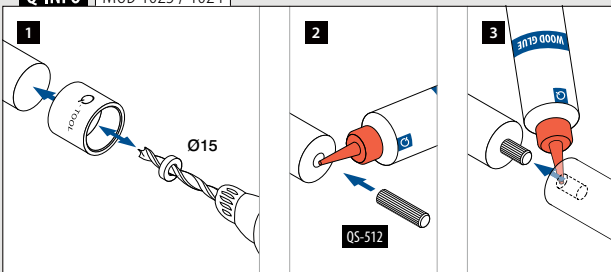

Q-INFO | MOD 0803

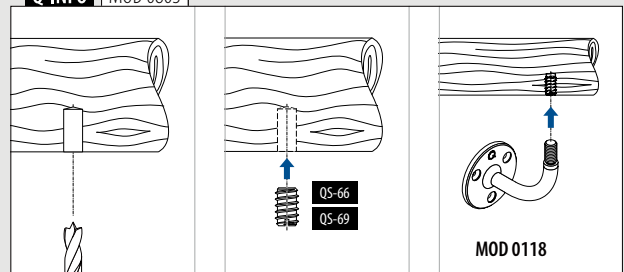

Montagezubehör



Q-glue®
Spezialkleber für Edelstahl.
Verbrauch pro Verbindung ca. 1 ml

MOD 1331

Zubehör			
	Q	e	
201331	Q-21	50 ml	1

Klebeverbindungen pro Flasche (50 ml)

Ø 16 mm	Ø 42,4 mm	Ø 48,3 mm	Ø 60,3 mm
150	60	50	40



Acrylat-Klebeband

MOD 1360

Zubehör				
	Q	W	L	
201360	Q-53	9	33 m (für 11 m Blendleiste)	1



Transparentes Acrylat-Klebeband

MOD 1362

Zubehör				
	Q	W	L	
201362-012	Q-122	12	33 m	1

NEW



Q-spray, transparent
Für die reibungslose Montage

MOD 0620

Zubehör			
	Q	e	
200620	Q-65	1000 ml	1



Q-seal
Glas-Silikon, Farbe schwarz,
mit beigelegten Düsen

MOD 1340

Zubehör			
	Q	e	
201340	Q-24	310 ml = ca. 11,40 m	1



Doppelseitiges Klebeband, geschäumt

MOD 1361

Zubehör				
	Q	W	L	
201361-012	Q-111	12,7	33 m	1
201361-016	Q-98	16	33 m	1
201361-020	Q-99	20	33 m	1
201361-025	Q-112	25,4	33 m	1



Applikationswerkzeug für Klebebänder

MOD 1040

Zubehör	
201040	1

NEW

Q-INFO | MOD 1360 / 1361 / 1362

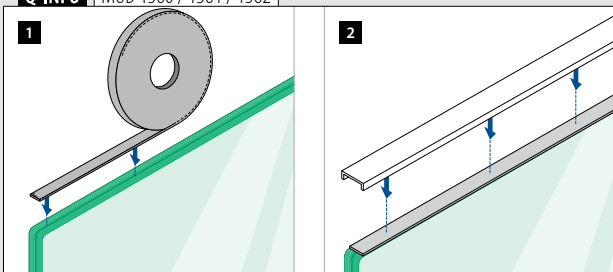

Q-INFO | MOD 0620

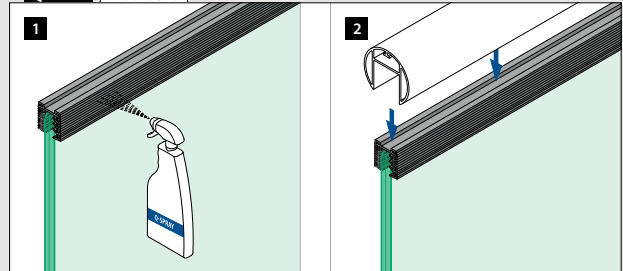

Q-INFO | MOD 1040

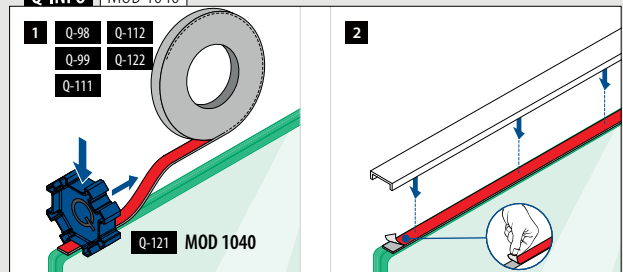

Montagezubehör

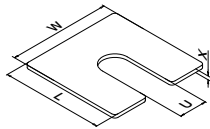

Unterlegscheiben zur Bodenmontage

MOD 8216 - Easy Glass® Smart

	Aluminium		Roh		
	W	L	U	X	
168216-001	58	58	16	1	100
168216-002	58	58	16	2	100
168216-003	58	58	16	3	100

MOD 8416 - Easy Glass® Prime

	Aluminium		Roh		
	W	L	U	X	
168416-001	69	69	24	1	100
168416-002	69	69	24	2	100
168416-003	69	69	24	3	100

MOD 8516 - Easy Glass® Max

	Aluminium		Roh		
	W	L	U	X	
168516-001	78	78	24	1	100
168516-002	78	78	24	2	100
168516-003	78	78	24	3	100

MOD 8616 - Easy Glass® Strong

	Aluminium		Roh		
	W	L	U	X	
NEW 168616-001	93	93	24	1	100
NEW 168616-002	93	93	24	2	100
NEW 168616-003	93	93	24	3	100



Montageplatten für Easy Glass®

MOD 1006

	Zubehör		Stärken	
	Q			
201006	Q-62		1, 2, 3, 4, 5 mm	520

Q-INFO MOD 1006

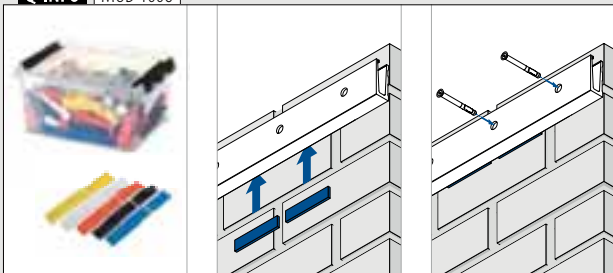

Q-INFO MOD 8x16

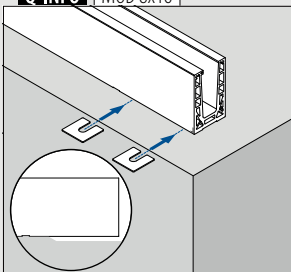

Q-INFO MOD 8x36 / 6636

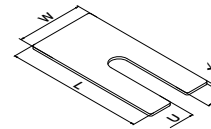
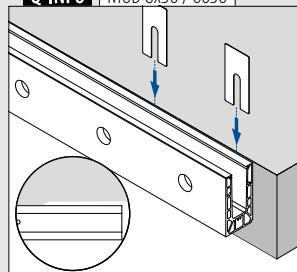

Unterlegscheiben zur Seitenmontage

MOD 8236 - Easy Glass® Smart

	Aluminium		Roh		
	W	L	U	X	
168236-001	58	120	16	1	100
168236-002	58	120	16	2	100
168236-003	58	120	16	3	100

MOD 8336 - Easy Glass® Smart+

	Aluminium		Roh		
	W	L	U	X	
NEW 168336-001	58	122	16	1	100
NEW 168336-002	58	122	16	2	100
NEW 168336-003	58	122	16	3	100

MOD 8436 - Easy Glass® Prime

	Aluminium		Roh		
	W	L	U	X	
168436-001	58	135	16	1	100
168436-002	58	135	16	2	100
168436-003	58	135	16	3	100

MOD 8636 - Easy Glass® Strong

	Aluminium		Roh		
	W	L	U	X	
NEW 168636-001	58	144	16	1	100
NEW 168636-002	58	144	16	2	100
NEW 168636-003	58	144	16	3	100

MOD 6636 - Easy Glass® Up

	Aluminium		Roh		
	W	L	U	X	
166636-001	58	89	16	1	100
166636-002	58	89	16	2	100
166636-003	58	89	16	3	100

Nivellierblock für Easy Alu

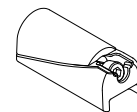

MOD 9027

	Aluminium		Q	
	OUTDOOR			
169027	Q-4			1



Q-INFO MOD 9027

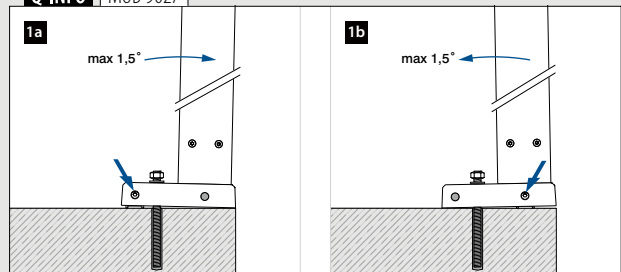



Q-cleaner

Edelstahl-Reinigungsspray,
konzentriert, ohne Freibgas

MOD 0601

Zubehör			
	Q	e	
200601	Q-23	300 ml	1



Q-ultra-clean

Chemischer Passivator und Edelstahl-
reiniger (zur Starkschmutz- und
Rostentfernung).

MOD 0610

Zubehör			
	Q	e	
200610	Q-22	500 ml	1



Q-protector

Schützt Aluminium- und Edelstahl-
komponenten direkt nach der Montage

MOD 0602

Zubehör			
	Q	e	
200602	Q-63	500 ml	1



Scotch®-Brite

Sehr feine Handschleifpads
Zum Entfernen von Kratzern auf
Edelstahlprodukten

MOD 0640

Zubehör			
	Q		
200640	Q-25		10



Q-glass tex

Glas-Reinigungstücher,
100% Viskose, 33x37cm

MOD 0660

Zubehör			
	Q		
200660	Q-27		20



Lackstift zur Ausbesserung von Kratzern

MOD 0802

Zubehör				Farbe	e	
	200802-31	Schwarz, RAL 9005	12 ml		1	
	200802-33	Anthrazitgrau, RAL 7016	12 ml		1	
	200802-34	Telegrau 4, RAL 7047	12 ml		1	

Q-INFO | MOD 0640 / 0610

Q-25



MOD 0610
Q-21
Q-ultra-clean

Q-INFO

Reinigung und Pflege-
informationen

9

Werkzeuge



Sechskant-Schraubendreher-Satz,
7-teilig

MOD 1010

Zubehör

SELL OUT	Q (□)							☐
201010	Q-2	Q-2,5	Q-3	Q-4	Q-5	Q-6	Q-8	1



Sechskant-Schraubendreher

MOD 1008

Zubehör

SELL OUT	Q (□)	☐
201008-10	Q-10	1



Zange für Blindnietmutter

MOD 1031

Zubehör

SELL OUT	Q	∅	☐
201031	Q-29	M6, M8, M10	1



Kunststoffhammer

MOD 1030

Zubehör

Q	☐	
201030	Q-45	1



Multiwasserwaage für Rohr, rund und eckig

MOD 1034

Zubehör

Q	☐	
201034	Q-46	1



Hakenschlüssel

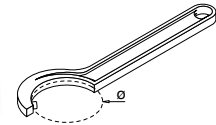

MOD 1013

Zubehör

	Q	∅	☐
201013-025	Q-30	25 - 28	1
201013-030	Q-31	30 - 32	1
201013-050	Q-32	45 - 50	1
201013-060	Q-33	58 - 62	1
201013-070	Q-51	68 - 75	1



Zweilochmutterdreher für ∅ 3 mm
Löcher, Pin 2,9 mm, Abstand 15 mm

MOD 1032

Zubehör

	Q	☐
201032	Q-78	1



Zange für Zweilochmuttern, für ∅ 2 mm
Löcher, Pin 4,0 mm, Abstand 28 mm

MOD 1033

Zubehör

	Q	☐
201033	Q-110	1



Multiwasserwaage für ∅ 40, ∅ 42,4,
∅ 48,3 mm

MOD 1035

Zubehör

	Q	☐
201035	Q-72	1

SELL OUT Nur solange der Vorrat reicht.

Q-INFO MOD 1034



Q-INFO MOD 1035



Q-INFO MOD 1035



Werkzeuge



Q-disc®- und Inlay-Werkzeug

MOD 1000

Zubehör		
	Q	
201000	Q-84	1



Easy Glass® Multitool

MOD 1001

Zubehör		
	Q	
201001	Q-71	1



Q-glass Saugheber, 2-Kopf, Tragkraft/Tragrichtung: 60 kg / parallel

MOD 1060

Zubehör		
	Q	
201060	Q-28	1



Glasmontagehilfe

MOD 1062

Zubehör		
	Q	
201062	Q-56	2



Plattentragehilfe
Spannweiten bis 80 mm
Maximallast pro Stück: 100 kg

MOD 1061

Zubehör		
	Q	
201061	Q-55	2

SELL
OUT

WERKZEUG

ZUBEHÖR

Q-INFO MOD 1000

- 1 Fixieren und Ausrichtung prüfen
- 2 Drehen
- 3 Ausrichten
- 4 Fixieren
- 5 Prüfen Sie die Montageanleitung zum Einstellen des Drehmomentschlüssels
- 6 Q-spray 200620

Q-INFO MOD 1001

- 1
- 2
- 3

Q-INFO MOD 1061

- 1
- 2
- 3

Q-INFO MOD 1062

- 1
- 2

Werkzeuge



Fast Fix Entriegelungswerkzeug

MOD 7802

V4A	316	Gebürstet		
OUTDOOR		Für Kabel Ø		
207802-003		3,2		1
207802-004		4,0		1



Drahtseil-Schere

MOD 7800

Zubehör				
	Q	Für Kabel Ø		
207800	Q-39	1,5 - 4,0		1

Edelstahl sollte mit einer geeigneten Säge geschnitten werden, um effizientes Arbeiten und ein optimales Ergebnis zu ermöglichen. Um dies zu gewährleisten hat die Edelstahlsäge einen extra starken aber langsam drehenden Motor. Das geringe Gewicht macht diese Säge zum professionellen Begleiter auf der Baustelle.

201070-23
Q-34

Montagesäge

Motor 0,8 kW - 230 V, 60 rpm, Kühlautomatik, 17 kg, Masse 490x425x600 (LxBxH), exklusive Sägeblatt, für gerade Zuschnitte

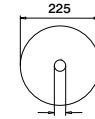
201071
Q-35Untergestell für
Montagesäge201072
Q-36Sägeblatt für
MontagesägeHSS, 225 x 2,2 x 32,
168 Z201074
Q-38Höhenverstellbare
Materialauflage mit
Kugelführung für Rohre
mit Ø26-168 mm201073
Q-44Aussen-/Innen-
Rohrentgrater,
für Rohre mit
Ø10-54 mm

MOD 1070 / 1071 / 1072 / 1073 / 1074

Zubehör

	Q		
201070-23	Q-34		1
SELL OUT 201071	Q-35		1
201072	Q-36		1
201073	Q-44		1
SELL OUT 201074	Q-38		1



























































SUCHEN SIE NACH Q-RAILING PROMOTIONARTIKEL?

Dann erkundigen Sie sich bei uns nach Displays, Mustersets und anderen Möglichkeiten.



Q-railing

SYMBOLVERZEICHNIS

V2A	304	304 Edelstahl (V2A)	(Verbund-)Sicherheitsglas	Monolithisch	Glas
V4A	316	316 Edelstahl (V4A)	(Verbund-)Sicherheitsglas	ESG/VSG	
	Aluminium	Aluminium	Buche	Eiche	Holz
	Kunststoff	Kunststoff	Kambala	Holz	
	Stahl	Stahl	Gebürstet	Hochglanzpoliert	Materialoberfläche
	Zinkdruckguss	Zinkdruckguss	INDOOR		Für Innenanwendung
	Stahl, verzinkt	Stahl, verzinkt	OUTDOOR		Für Aussenanwendung
	Messing	Messing			
 /  /  / \emptyset		Form/Grösse des Rohrs/Glasleistenrohrs			Grösse des Bohrkopfes
		Extra Produktinformation	 QS-36  467 /  QS-36		Diese Q-Anker benutzen, siehe Seite 467
T		Glasstärke	 QS-53  472 /  QS-53		Diese Q-Schraube benutzen, siehe Seite 472
		Verpackungseinheit	Q-22		Dieses Werkzeug benutzen
NEW		Neues Produkt			CE-Kennzeichnung
SELL OUT		Ausverkaufartikel (nur verfügbar solange der Vorrat reicht)	EXTRA STRONG		Extra stark
PREFIX		Prefix-Optionen verfügbar			
 		Versand per Spedition			AVIS Technique-Label
		Produkt wird geschraubt (Sechskant-Schraubendreher)			Geprüft von CSTB
		Drehmomentschlüssel	 		SIA 358:2010 / SIA 261:2014
		Produkt wird geschraubt (Schlüssel)	 		Geprüft gemäss EN 1991 / EN 1990
		Hakenschlüssel			Geprüft gemäss NEN 2608 (Eurocodes 1990-1999:2011)
		Schraubendreher			LGA Typen geprüft-Label
		Vielzahn-Schraubendreher			Statische Berechnung gemäss DIN 18008
		Produkt wird eingeschlagen (Easy Hit®)			CTE-Label
		Produkt wird geklebt			Geprüft von Applus
		Produkt wird geschnitten			Geprüft gemäss NTC UNI 11678-2017
		Produkt wird gesägt			Geprüft gemäss DIN 18008
		Produkt wird geschweisst			Geprüft von WTCB.be & CSTC.be
		AW-Antrieb			Geprüft gemäss NBN B03-004
		90° Ecke nicht möglich			Geprüft gemäss Miami Dade County
		Wandabstand 85 mm			Geprüft von International ICC Evaluation Service
		AbP-Label (Allgemeines bauaufsichtliches Prüfzeugnis)			IK-Code (Stossfestigkeitswert)
		ETB-Label			Farbwiedergabe-Index
		AbZ-Label (Allgemeine bauaufsichtliche Zulassung)			Dali Lighting Control
		Gemäss DIN/EN 12600 geprüft			Minimaler Biegeradius
		Gemäss British Standard 6180 geprüft			Installation durch eine zugelassene Elektrofachkraft
		Verrotec-Label			

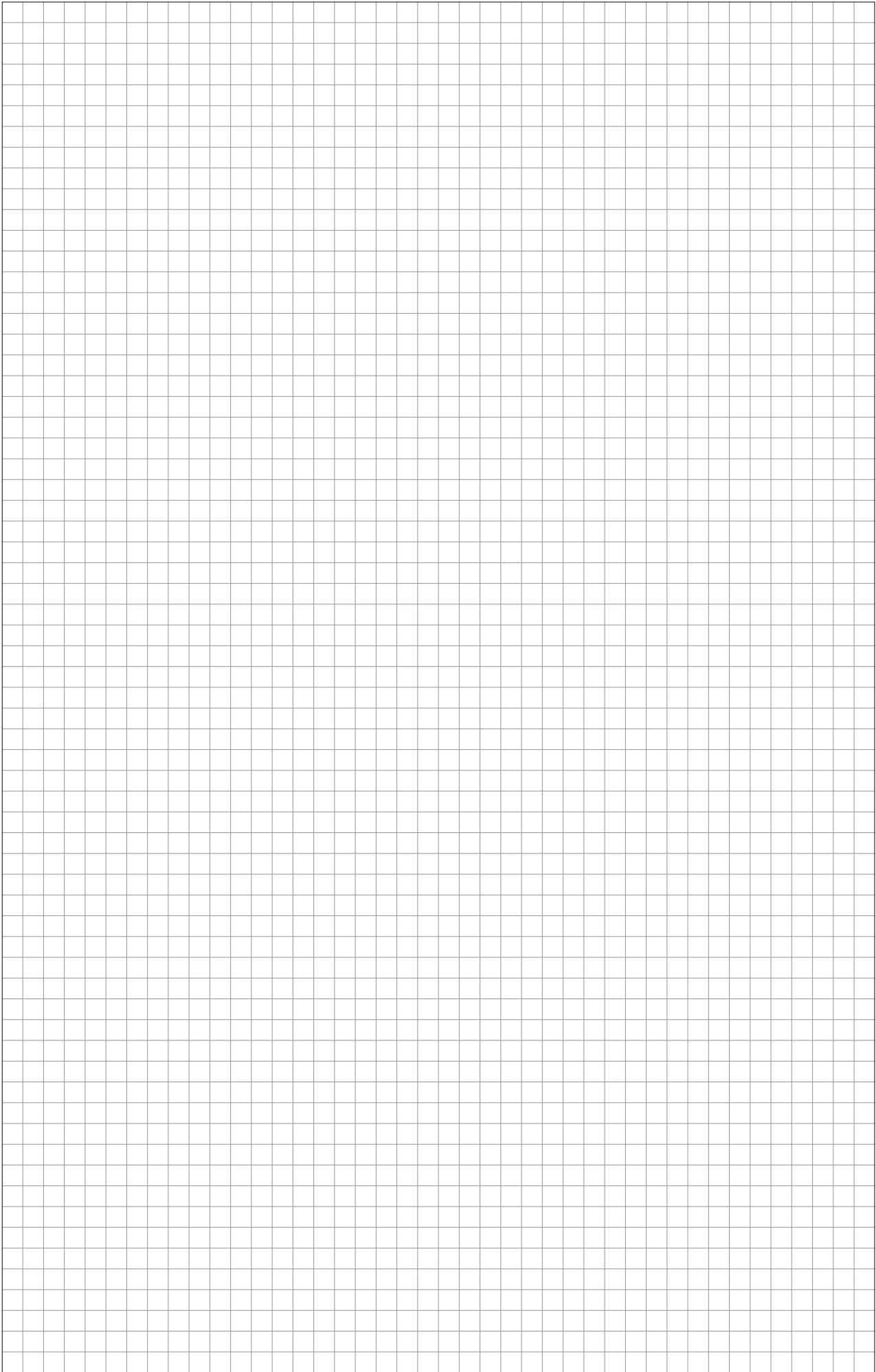

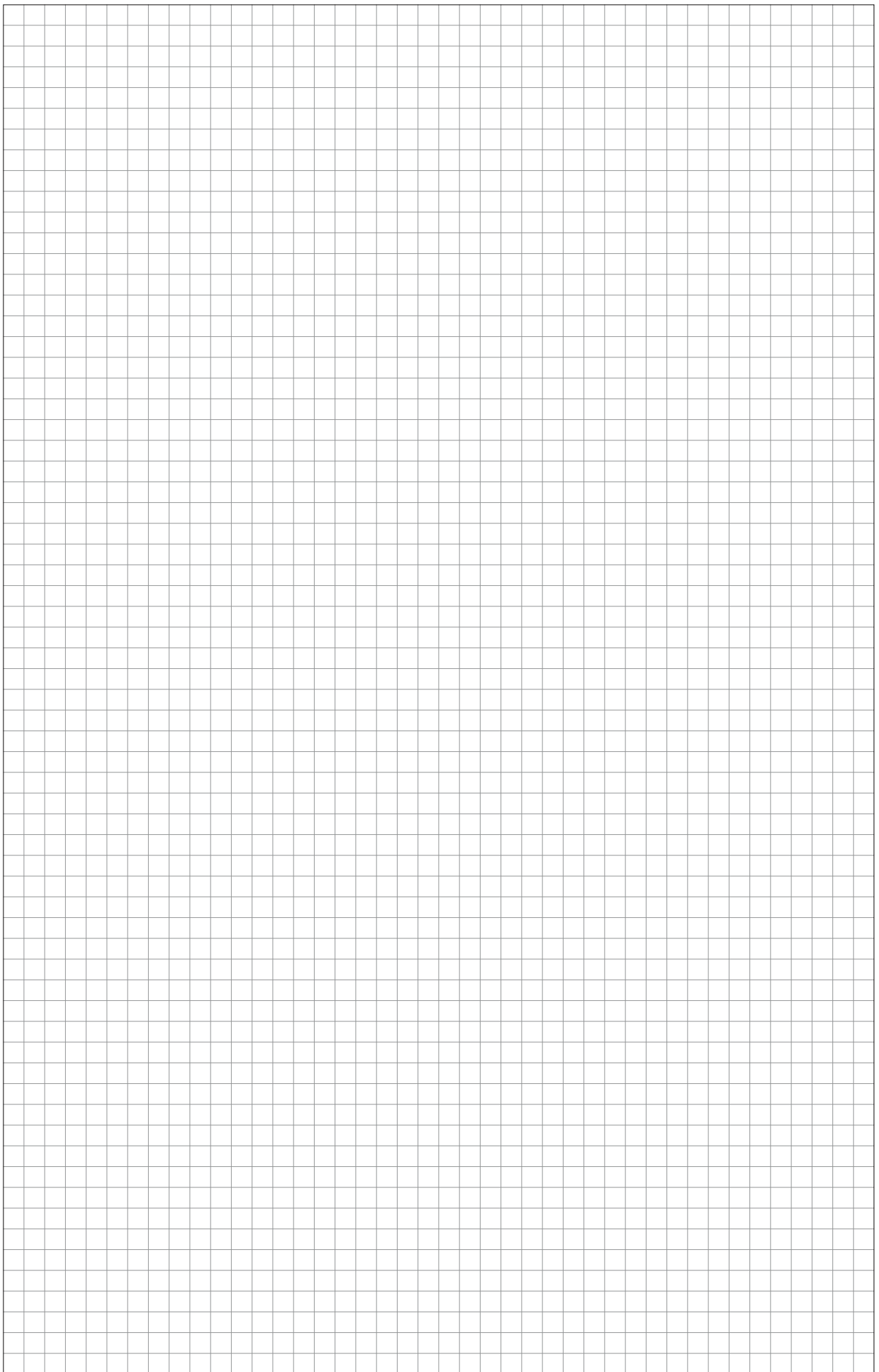



© 2023 Q-railing
Emmerich am Rhein, Deutschland

Urheberrecht / Copyright

Die Gestaltung, das Layout dieses Kataloges, Texte, Textteile, Tabellen, Bilder, Marken, Warenzeichen, Logos, Grafiken und andere Inhalte dieses Kataloges stehen entweder im Eigentum der Q-railing Europe GmbH & Co. KG, Deutschland oder werden mit Einwilligung des Eigentümers verwendet. Sie unterliegen weltweitem Urheberrecht. Soweit nicht anders angegeben sind alle in diesem Katalog verwendeten Marken und Warenzeichen sowie Kennzeichenrechte, Geschmacksmuster und Gebrauchsmuster Eigentum der Q-railing Europe GmbH & Co. KG, Deutschland oder unserer Geschäftspartner. In Deutschland und in vielen anderen Ländern ist sowohl eine strafrechtliche als auch eine zivilrechtliche Verfolgung von Verstößen gegen das Urheberrecht, Markenrecht und weiterer Schutzrechte möglich. Sollten Sie einzelne Inhalte oder komplette Seiten verwenden, kopieren, reproduzieren, im weitesten Sinne verändern, übersetzen und oder an Dritte weiterreichen oder weiterreichen wollen, so benötigen Sie unsere Einwilligung, welche wir nur schriftlich im Voraus erteilen. Fragen Sie uns also bitte vorab. Anderenfalls behalten wir uns rechtliche Schritte gegen Sie vor.



BITTE BEACHTEN

Fertigungstechnische Änderungen sowie Massabweichungen bleiben vorbehalten. Die Originalprodukte können sich von den Fotodarstellungen geringfügig unterscheiden. Ein Reklamationsanspruch entsteht hieraus nicht. Druckfehler vorbehalten. Eine Haftung von Q-railing, gleich aus welchen Rechtsgründen, ist ausgeschlossen, sofern nicht rechtlich zwingend gehaftet wird. Hier begrenzt sich die Haftungssumme auf den reinen Warenwert des Auftrages, eine darüber hinaus gehende Haftungssumme ist ausgeschlossen. Bitte beachten Sie die gesetzlichen Vorgaben, die von Land zu Land unterschiedlich sein können. Q-railing haftet nicht für Auflagen und Bestimmungen, die für den jeweiligen Montageort Gültigkeit haben.

Es gelten unsere allgemeinen Geschäftsbedingungen. Diese finden Sie auf www.q-railing.com.





THE PREMIUM BRAND IN RAILING SYSTEMS

Q-railing Schweiz
St. Gallerstrasse 23
9524 Zuzwil SG
Schweiz

T. +41 (0)71 945 70 30
F. +41 (0)71 945 70 29
sales@q-railing.ch



Q-RAILING CATALOGUE 2023, CH • LANGUAGE DE • NO CURRENCY