

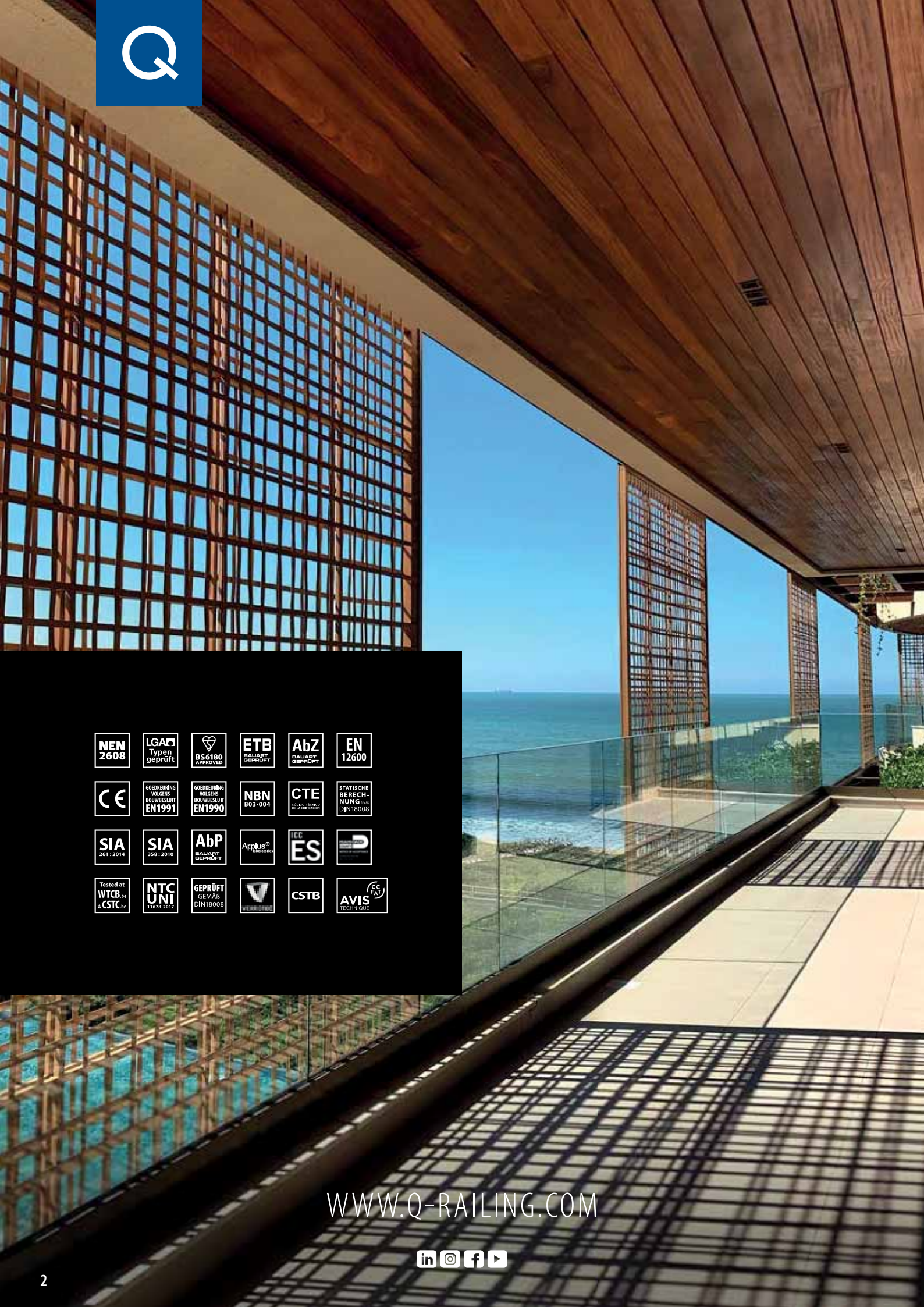

B^{FR}

EDITION
À partir de 2023





NEN 2608	LGAM Typen geprüft	BS 6180 APPROVED	ETB BALAJART GEPRÜFT	AbZ BALAJART GEPRÜFT	EN 12600
CE	GOEDKEURING VOLGENS BOUWBESLUIT EN1991	GOEDKEURING VOLGENS BOUWBESLUIT EN1990	NBN B03-004	CTE CONFORME TECNICO DE PROTECCION	STATISCHE BERECHNUNG GEMÄß DIN18008
SIA 261 : 2014	SIA 358 : 2010	AbP BALAJART GEPRÜFT	AppPlus® laboratoire	ICC ES	D
Tested at WTCB & CSTC	NTC UNI 11678-2017	GEPRÜFT GEMÄß DIN18008	V	CSTB	AVIS TECHNIQUE CE FAI

WWW.Q-RAILING.COM



BIENVENUE CHEZ LA MARQUE PAR EXCELLENCE DES SYSTÈMES DE GARDE-CORPS

Que signifie l'« excellence » pour nous ?
Nous cherchons inlassablement à atteindre
la perfection à laquelle vous aspirez.

L'EXCELLENCE EN TOUT POINT

Le meilleur, sinon rien

- Qualité constante
- Matériaux de choix
- Surfaces et finitions irréprochables
- Précision extrême des dimensions et des tolérances

Rapidité extrême

- Stock important
- Livraison rapide
- Conseil technique personnalisé et détaillé

Des possibilités pour chaque situation

- Large gamme de produits
- Grande variété de styles
- Tout ce dont vous avez besoin pour créer une main courante ou un garde-corps complet
- Associez différents éléments pour composer un ensemble sur-mesure

Sécurité optimale

- Précision extrême des dimensions et des tolérances
- Contrôles approfondis effectués par des autorités de premier plan et des organismes indépendants et certifiés
- Essais et certifications officielles conformes aux principaux codes et normes de construction internationaux

La beauté et l'intelligence

- Nombreuses innovations et améliorations de produits chaque année
- Des designs pour tous les goûts
- Propriétés qui facilitent le montage

Ressources en ligne : www.q-railing.com

- Vidéos d'assemblage, objets BIM, dessins CAO et autres spécifications techniques
- Logiciel Q-PAC (Professional Anchor Calculation) qui vous permet d'identifier facilement le goujon Q-railing adapté
- Catalogues, brochures, projets de référence, etc.



1

SYSTÈMES DE GARDE-CORPS TOUT EN VERRE

APERÇU DES SYSTÈMES

6 - 7

COMMENT TROUVER FACILEMENT UN PRODUIT

8 - 9

PIÈCES POUR SOCLES DE GARDE-CORPS

VERRE ET PINCES DE LIAISON

PIÈCES POUR MAINS COURANTES

26 - 185



2

SYSTÈMES DE PROTECTION DE FENÊTRES

APERÇU DES SYSTÈMES

10 - 11

COMMENT TROUVER FACILEMENT UN PRODUIT

10 - 11

EASY GLASS® VIEW

EASY GLASS® MOD 6507-6508

AVEC PINCES À VERRE

AVEC ADAPTATEURS À VERRE

BARRES D'APPUI

186 - 231



3

SYSTÈMES Q-LIGHTS

APERÇU DES SYSTÈMES

12 - 13

COMMENT TROUVER FACILEMENT UN PRODUIT

12 - 13

SPOTLIGHT POUR MAIN-COURANTE

LINEAR LIGHT POUR TUBES À FOND DE GORGE

LINEAR LIGHT POUR MAIN-COURANTE

232 - 265



4

SYSTÈMES DE GARDE-CORPS À POTEAUX

APERÇU DES SYSTÈMES	14 - 15
COMMENT TROUVER FACILEMENT UN PRODUIT	16 - 17
PIÈCES POUR POTEAUX	
PIÈCES POUR MAINS COURANTES	
PIÈCES POUR REMPLISSAGES	

266 - 419



5

SUPPORTS DE REMPLISSAGE EN VERRE

TROUVEZ VOTRE FIXATION POUR VERRE	423 - 430
PINCES À VERRE	430 - 442
SUPPORTS DE VERRE	444 - 445
PINCES DE LIAISON	446 - 448
CHARNIÈRES ET LOQUETS	448 - 449
ADAPTATEURS À VERRE	451 - 453

420 - 453



6

ACCESSOIRES

APERÇU Q-VISSERIE	456
TROUVER LA BONNE FIXATION	457 - 463
GOUJONS	464 - 467
VIS ET MATÉRIEL DE FIXATION	468 - 474
PIÈCES DÉTACHÉES POUR PINCES ET ADAPTATEURS À VERRE	475
PERÇAGE ET TARAUDAGE	476 - 477
ACCESSOIRES D'AIDE À L'INSTALLATION	478 - 481
NETTOYAGE ET ENTRETIEN	482
OUTILLAGE	483 - 485
INDEX DES SYMBOLES	487

454 - 487



1

SYSTÈMES DE GARDE-CORPS TOUT EN VERRE

26 - 185



EASY GLASS® SMART

≡ 12 - 21,52 mm ▲ ● H | IHI



EASY GLASS® SMART+

≡ 16,76 - 21,52 mm ▲ H | IHI

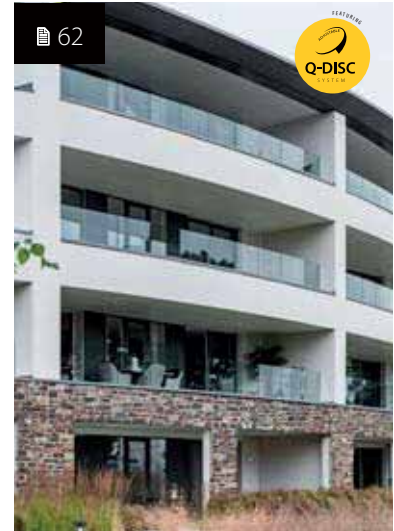

EASY GLASS® PRIME

≡ 16,76 - 25,52 mm ▲ H | IHI



EASY GLASS® MAX

≡ 19 - 31,52 mm ● IHI | IIII



EASY GLASS® UP

≡ 12 - 17,52 mm ● H | IHI



EASY GLASS® HYBRID

≡ 8 - 13,52 mm ● H | IHI

Que votre projet concerne une maison ou un stade de 100 000 places assises, il implique toujours l'optimisation de la lumière et de l'espace. Les systèmes Q-railing vous permettent d'obtenir une transparence maximale dans un cadre lumineux et ouvert, sans rupture visuelle.



82
EASY GLASS® **STRONG**
= 21,52 - 33,04 mm ▲ | H | H | H



94
EASY GLASS® **SLIM**
= 12 - 21,52 mm ● H



104
EASY GLASS® **PRO**
= 12 - 21,52 mm ▲ ● H | H



140
EASY GLASS®
PINCES À VERRE DE SOL
= 12 - 21,52 mm ● H | H



146
EASY GLASS® **AIR**
= 15 - 21,52 mm ● H | H



150
EASY GLASS®
ADAPTATEURS À VERRE
= 8 - 25,52 mm ▲ ● H | H

= = Epaisseur de verre ▲ = Ajustable ● = Non-ajustable
H = Installation légère | H = Installation moyenne | H | H = Installation résistante || H | H = Installation très résistante



1

SYSTÈMES DE GARDE-CORPS TOUT EN VERRE

26 - 185

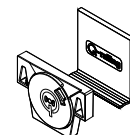
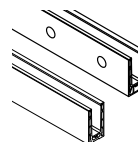

A

BASES DE GARDE-CORPS

PROFIL DE SOL

FIXATION POUR VERRE

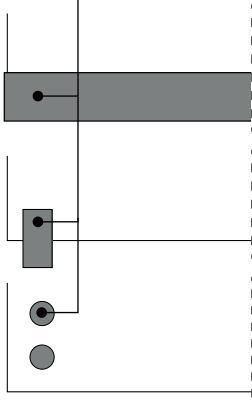

EASY GLASS® SMART	33, 36, 38, 44	31-32
EASY GLASS® SMART+	54, 55	53
EASY GLASS® PRIME	66, 68, 70, 76	65
EASY GLASS® STRONG	86, 88	85
EASY GLASS® SLIM	97, 99, 100	96
EASY GLASS® PRO	108, 110, 112, 114	106-107
EASY GLASS® MAX	119, 121, 122, 124	118
EASY GLASS® UP	130, 131	128
EASY GLASS® HYBRID	136	136
EASY GLASS® PINCES À VERRE DE SOL		
EASY GLASS® AIR		
EASY GLASS® ADAPTATEURS À VERRE		

B

VERRE

Q-GLASS

PINCES DE LIAISON

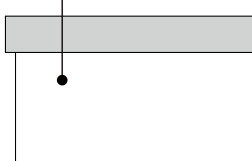

VERRE SUR-MESURE	160	162-164
PANNEAU DE VERRE STANDARD	161	

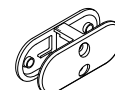

C

MAINS COURANTES

PROFILÉ DE MAIN COURANTE EDGE

PROFILÉ EN U DE MAIN COURANTE EDGE

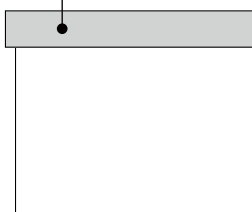

EASY GLASS® SMART	166	167
EASY GLASS® SMART+		
EASY GLASS® PRIME		
EASY GLASS® STRONG		
EASY GLASS® SLIM		
EASY GLASS® PRO		
EASY GLASS® MAX		
EASY GLASS® UP		
EASY GLASS® HYBRID		
EASY GLASS® PINCES À VERRE DE SOL		
EASY GLASS® AIR		
EASY GLASS® ADAPTATEURS À VERRE		

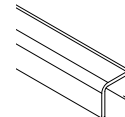
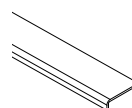

COMMENT TROUVER FACILEMENT UN PRODUIT

Nos systèmes de garde-corps sont généralement composés de trois sections : les bases de garde-corps **A**, verre **B** et mains courantes **C**. Chaque section comprend différentes familles de produits. Repérez la section et la famille dont fait partie votre produit pour trouver rapidement ce que vous cherchez.

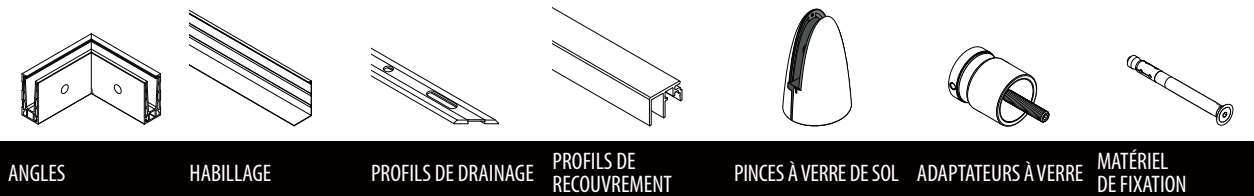
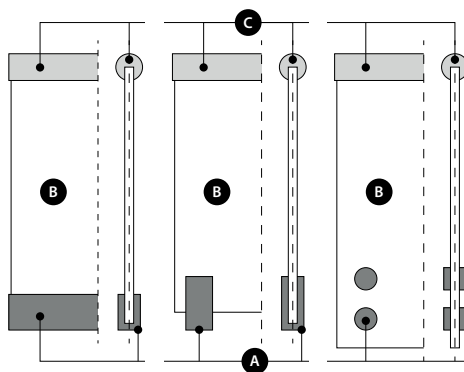

ANGLES	HABILLAGE	PROFILS DE DRAINAGE	PROFILS DE RECOUVREMENT	PINCES À VERRE DE SOL	ADAPTATEURS À VERRE	MATÉRIEL DE FIXATION
34, 37, 38, 45	42, 47	35, 41	37, 48-49			456-463
54-55	57	56	59-60			
66, 69, 70, 77	74, 79	67, 73	80-81			
86, 88	91	87, 90	92-93			
97, 99, 100	102	98				
109, 110, 112, 115	113, 115	109, 112				
123, 121, 122, 124	123, 125					
130, 131	132	133				
				142-145		
				148		
					152-159	

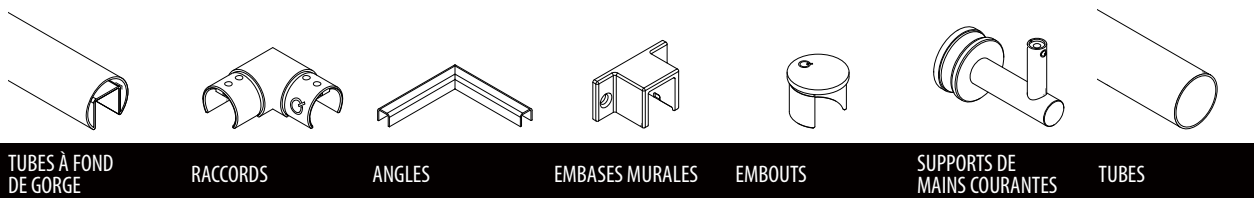

169-170, 174, 176, 178, 180, 182, 184	169, 171-173, 175, 177, 179, 181, 183, 185	166, 168, 174, 178	173, 177, 181, 182, 184	168, 169, 173, 174, 177, 178, 181, 182, 185	286, 297, 340-341, 365	285, 300, 351, 367
137-138			137-138			
169-170, 174, 176, 178, 180, 182, 184	169, 171-173, 175, 177, 179, 181, 183, 185 148	166, 168, 174, 178	173, 177, 181, 182, 184 149	168, 169, 173, 174, 177, 178, 181, 182, 185 149	286, 297, 340-341, 365	285, 300, 351, 367 149
	169, 171-173, 175, 177, 179, 181, 183, 185	166, 168, 174, 178	173, 177, 181, 182, 184	168, 169, 173, 174, 177, 178, 181, 182, 185	286, 297, 340-341, 365	285, 300, 351, 367



2

SYSTÈMES DE PROTECTION DE FENÊTRES

186 - 231



EASY GLASS® VIEW

12 - 21,52 mm



EASY GLASS® MOD 6507 / 6508

8 - 21,52 mm

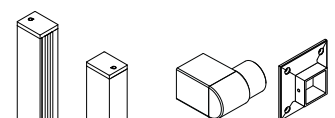

PROFILS DE MUR

EMBASES MURALES

PROTECTION DE FENÊTRES

EASY GLASS® VIEW	192-193, 195	
EASY GLASS® MOD 6507 / 6508		200-208
AVEC PINCES À VERRE		
AVEC ADAPTATEURS À VERRE		
BARRES D'APPUI		220-221, 223-230

Un balcon à la française modifie significativement l'aspect général d'une façade. Pour vous garantir une harmonie de style dans tous vos projets, nos balcons à la française se déclinent en un large choix de solutions et d'esthétiques.



AVEC PINCES À VERRE

== 9,52 - 21,52 mm

● H | HI



AVEC ADAPTATEURS À VERRE

== 8 - 31,52 mm

▲ H | HI



BARRES D'APPUI

● H

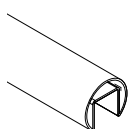

TUBES À FOND DE GORGE

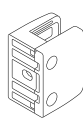

PINCES À VERRE

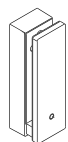

ADAPTATEURS À VERRE

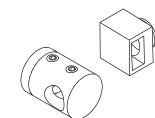

SUPPORTS AXIAUX

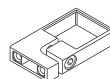

ENTRETOISES

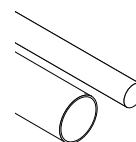

BARRE ET TUBE



EMBOUTS

						197
200-207, 209						
	211					
		213-217				
			219, 222	221	219-221, 223-231	219, 221-222, 225

== = Epaisseur de verre ▲ = Ajustable ● = Non-ajustable

H = Installation légère HI = Installation moyenne



3

SYSTÈMES Q-LIGHTS 232 - 265



Q-LIGHTS **SPOTLIGHT**

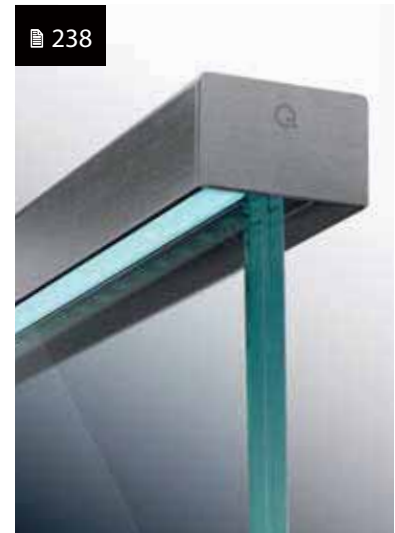

Q-LIGHTS **LINEAR LIGHT**

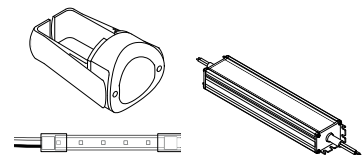

BANDES LED /
SPOTS À LED

TRANSFORMATEURS

SECTION PRODUIT

Q-LIGHTS SPOTLIGHT	236	237
Q-LIGHTS LINEAR LIGHT	238, 245	239, 246

Créez une lumière d'ambiance et un environnement sécurisé en habillant votre garde-corps d'un magnifique éclairage.

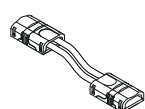

CONNECTEURS

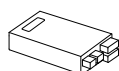

CONTRÔLEURS

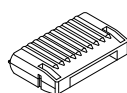

ALIMENTATIONS

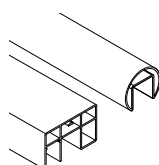

TUBES À FOND DE GORGE
/ MAINS COURANTES

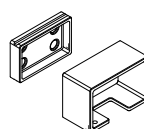

EMBASES MURALES

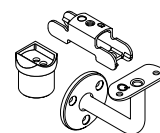

SUPPORTS ET ADAPTATEURS
DE MAINS COURANTES

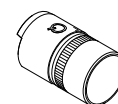

RACCORDS

			351	265	260-262	352-355
240-242, 247-251	252	252-253	254, 257, 259	254, 265	256, 258, 260-262	255, 263-264



4

SYSTÈMES DE GARDE-CORPS À POTEAUX

266 - 419



EASY ALU



SQUARE LINE® 40x10

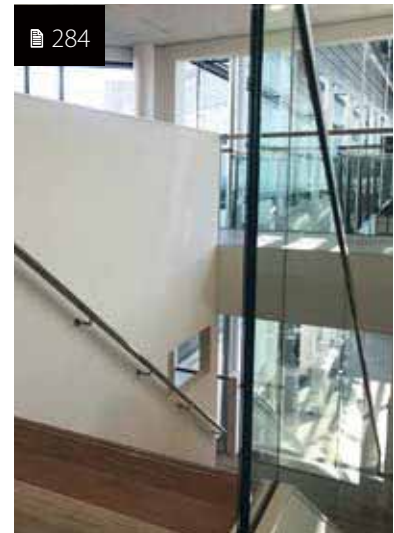

SQUARE LINE® 40x20



BARRIER LINE



Q-LINE POLI MIROIR



PIÈCES À SOUDER

Pour apporter une touche d'élégance à votre cage d'escalier, balcon ou atrium, choisissez un système de garde-corps à poteaux Q-railing. Avec notre large gamme de produits, il existe des solutions pour toutes les configurations de construction et contraintes de conception.



SQUARE LINE® 40x40

H



SQUARE LINE® 60x30

H | H-H



Q-LINE

H | H-H



BENDYWOOD



NATURAIL



REPLISSAGES



4

SYSTÈMES DE GARDE-CORPS À POTEAUX

266 - 419

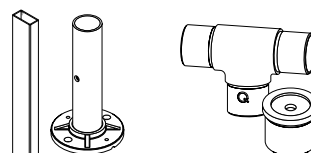

A

POTEAUX

POTEAUX

RACCORDS / ADAPTATEURS

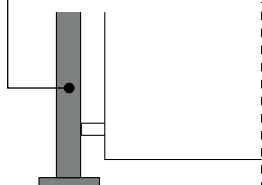

EASY ALU	270, 273	
SQUARE LINE® 40x40	290-291	296, 301
SQUARE LINE® 60x30	304	305
Q-LINE	310-314, 316, 320-322	332-333, 354, 356
BARRIER LINE	361	
Q-LINE POLI MIROIR	363	365, 368

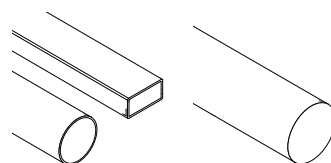

TUBES

MAINS COURANTES EN BOIS

B

MAINS COURANTES / GARDE-CORPS MURAUX

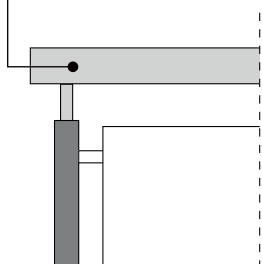

EASY ALU	275-276	
SQUARE LINE® 40x10	282	
SQUARE LINE® 40x20	285	
SQUARE LINE® 40x40	300	
SQUARE LINE® 60x30	305, 307	
Q-LINE	351	383-384
Q-LINE POLI MIROIR	367	
BENDYWOOD		383
NATURAIL		384

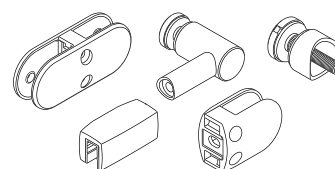

C

REMPLISSAGES

SUPPORTS DE REMPLISSAGE EN VERRE

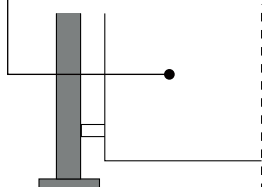

EASY ALU	
SQUARE LINE® 40x40	
SQUARE LINE® 60x30	431-453
Q-LINE	
Q-LINE POLI MIROIR	432-434, 438, 452-453

COMMENT TROUVER FACILEMENT UN PRODUIT

Nos systèmes de garde-corps sont généralement composés de trois sections : les poteaux **A**, les mains courantes **B** et les remplissages **C**. Chaque section comprend différentes familles de produits. Repérez la section et la famille dont fait partie votre produit pour trouver rapidement ce que vous cherchez.

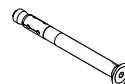
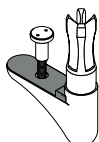
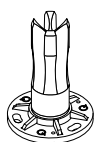
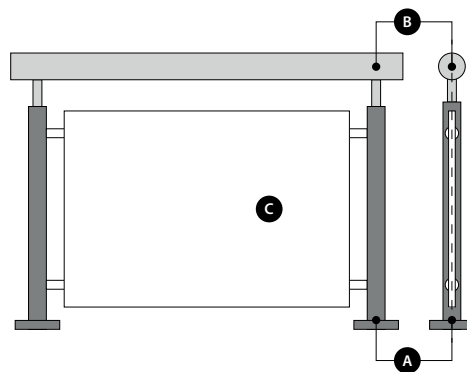

EMBASES-MANCHONS

CACHE EMBASES

EMBASES-MANCHONS,
FIXATION TRAVERSANTE

SUPPORT MURAL
POUR POTEAU

PIÈCES À SOUDER

MATÉRIEL
DE FIXATION

271	274		274		457-473
290, 292	290-292		293	374	
304	304-305		305	374	
310-312, 316	310-312, 315	322-323	317-319	373-374	
312	361				
			363		

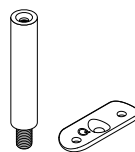
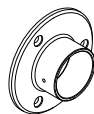
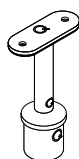
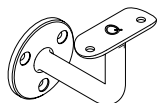

SUPPORTS DE
MAINS COURANTES

SUPPORTS
POUR POTEAU

RACCORDS / EMBOUTS

EMBASES MURALES

PIÈCES DE
MAINS COURANTES

PIÈCES À SOUDER

		277-279	278		375-379
282		283			
286-287		285	285		
297-299	294-295	300-301	301	296	
	306	305, 307	307	305	
338-349	324-326, 328-332, 349	352-358	359	329, 334-337	
365-366	364	367-368	368		
345-346, 349	324-326, 338	385			

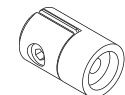
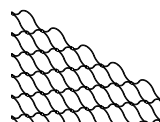
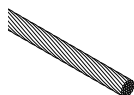
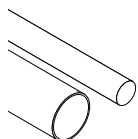

ENCADREMENT
DEVITRAGE

VERRE

BARRE ET TUBE

CÂBLE

FILET

PINCES À TÔLE

388-390	386-387	392-394, 396-397, 399, 401-403	405-411	413-414	417-419
		392-393, 395-397, 401-403			370-371
		369			

Easy Glass® Smart+

Vous cherchez une solution vous permettant d'installer rapidement du verre de 21,52 mm d'épaisseur et d'aligner chaque panneau de verre individuellement ? Easy Glass® Smart+ est fait pour vous ! Ce nouveau profil de sol inclut le Q-disc® System ajustable qui facilite l'alignement du verre.

📄 50

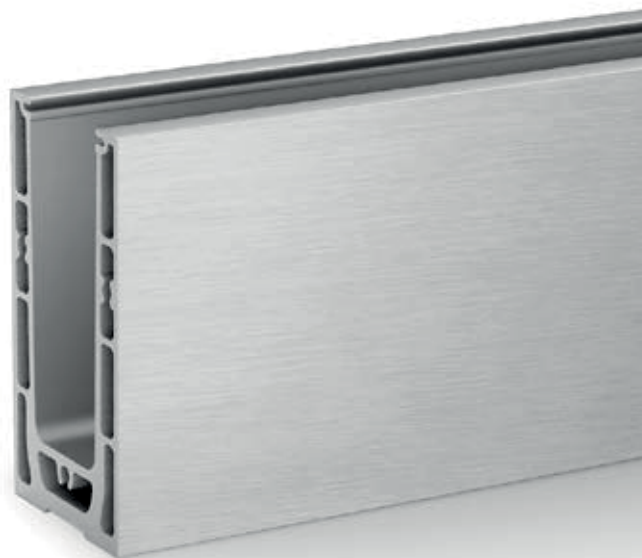

NEW 2023



Easy Glass® Strong

Notre système de garde-corps en verre Easy Glass Strong est un canal de base ultra résistant vous offrant une ajustabilité maximale grâce à notre Q-disc® System révolutionnaire. Sa résistance et son ergonomie le rendent idéal pour les stades, les aéroports, les centres commerciaux et autres lieux publics.

📄 82

Différentes solutions de protection de fenêtres

Découvrez les nouveautés d'Easy Glass® View. Les nouveaux profils préperçés et les profils intermédiaires vous permettent d'installer rapidement et facilement des protections de fenêtres encore plus large. Et notre gamme inclut plus de solutions de balcon à la française que vous ne le pensez : vous pouvez également utiliser des pinces à verre, des adaptateurs à verre, des barres d'appui ou le système Easy Alu pour créer une protection anti-chute à la fois élégante et résistante pour les fenêtres allant du sol au plafond.

📄 188



BLACK LINE



La gamme Black Line met à votre disposition tous les produits noirs dont vous avez besoin pour créer un système de garde-corps à poteaux ou en verre complet avec une élégante teinte sombre.



Supports de main-courante

Découvrez notre vaste gamme de nouveaux supports de main-courante Q-line et Square Line®.

Bandes LED et connecteurs Linear Light

Découvrez notre vaste gamme Q-lights Linear Light comprenant des bandes LED, des connecteurs et des transformateurs. Sa grande densité de LED par mètre permet à Linear Light de changer complètement l'ambiance d'un lieu, ainsi que de sécuriser davantage un garde-corps. L'installation de Linear Light au garde-corps que vous avez choisi est également très facile.

238



Bandes de LED multicolores

Envie d'une explosion de couleurs ? Sublimez vos mains-courantes, garde-corps, passerelles et escaliers avec nos bandes de LED multicolores qui leur confèrent une ambiance haute en couleur. Disponible à la demande.

Catalogue numérique

Vous préféreriez utiliser notre catalogue dans une version numérique ? Retrouvez-le en ligne ou téléchargez-le au format PDF sur www.q-railing.com.

Besoin d'aide ou de conseils ?

Q-railing s'attache à vous offrir un service personnalisé et se fait toujours un plaisir de vous assister dans vos projets ! Envoyez-nous un e-mail ou appelez-nous pour nous poser vos questions, nous demander un devis ou passer commande. Nous sommes à votre disposition.

Plus d'infos avec les QR codes

Scannez les QR codes figurant sur les pages de nos systèmes ! Vous accédez directement à leur page dédiée comprenant toutes les informations disponibles. Laissez-vous inspirer par les photos de différents projets et trouvez les informations dont vous avez besoin sur nos vidéos d'assemblage, manuels de produit, rapports d'essai et dessins CAO.

SCAN ME!



NOS MATÉRIAUX, COULEURS ET SURFACES



304

316

Inox

Résistant et d'aspect esthétique, l'inox est l'un des matériaux les plus appréciés pour les systèmes de garde-corps. Il en existe plusieurs types, caractérisés par de légères variations de composition. L'acier est naturellement sensible à la corrosion, mais divers éléments y sont ajoutés pour le rendre inoxydable. L'inox 304 correspond au standard de l'industrie pour un usage intérieur. Toutefois, l'inox 316 contient 2 % de molybdène, qui lui assure une résistance supplémentaire aux fissures, aux points de rouille et aux dégradations causées par la tension. Nous conseillons donc généralement l'inox 316 pour l'extérieur.



Plastique

Le thermoplastique que nous utilisons présente une excellente résistance chimique et mécanique. Il peut aussi être fabriqué dans n'importe quelle couleur RAL pour compléter votre système de garde-corps. Ce matériau offre un bon compromis entre la résistance à l'impact, à la chaleur, aux produits chimiques et à l'abrasion. Sa stabilité dimensionnelle, sa résistance à la traction, la dureté de sa surface et ses caractéristiques électriques sont également très satisfaisantes.



Aluminium

Robuste et léger à la fois, l'aluminium est naturellement protégé de la corrosion par une couche d'oxyde. Mais celle-ci doit être renforcée pour plus de protection. La plupart des produits en aluminium du catalogue sont composés de métal anodisé (25 μ). Dans le cas contraire, le matériau est décrit comme de l'aluminium « brut de laminage ».

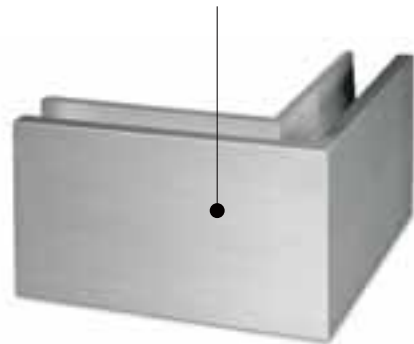

Zamak

Robuste et bon marché, le zamak moulé est une alternative économique à d'autres métaux. Pour lui donner plus d'éclat, vous pouvez lui appliquer un vernis ou un revêtement. D'ailleurs, de nombreux produits en zamak de Q-railing sont déjà thermolaqués pour vous simplifier la vie.















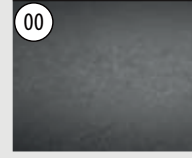
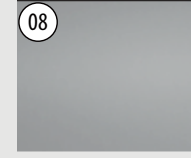

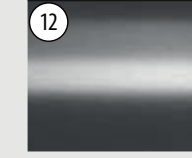







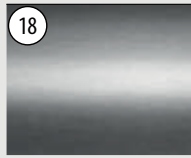

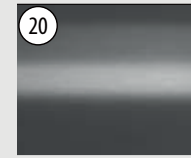
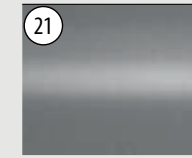
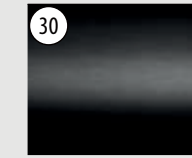



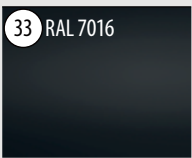

Acier

L'acier comprend différents alliages ayant chacun un usage précis. Sa résistance mécanique et à la rupture est liée à une teneur précise en fer, en carbone et en d'autres éléments. Il peut notamment embellir votre projet lorsqu'il est thermolaqué dans la couleur de votre choix.

Les couleurs et surfaces disponibles sont indiquées ci-dessous.
 Dans la plupart des cas, les deux derniers chiffres des références
 d'article correspondent à la couleur et/ou la surface.

158238-**36**
 133507-033-**12**
 168410-050-00-**82**

Couleur/surface disponible

00  Brut	00  Brut	00  Brut	08  Effet argenté mat	10  Poli miroir	12  Inox brossé
					
17  Chromé brillant	18  Brossé, anodisé	19  Aspect inox brossé	20  Aspect inox brossé	21  Aspect inox brossé	30  Revêtement électrophorétique*
					
33 RAL 7016  Gris anthracite, mat, uni	36 RAL 9006  Aluminium blanc, brillant de soie, uni	80 RAL 9005  Noir, brillant de soie, texture	Disponible en  Inox  Aluminium  Zamak  Acier  Plastique		*Le revêtement, également appelé traitement par électrophorèse, est une fine couche de 15 µ qui protège (apprêt) les produits en acier. Après le revêtement, le produit reçoit le traitement de surface final, qui peut être plaqué ou thermolaqué.
					

Thermolaqué

32 RAL 9016  Blanc, brillant de soie, uni	33 RAL 7016  Gris anthracite, mat, texture	34 RAL 7047  Telegris 4, brillant de soie, uni	82 RAL 9005  Noir, mat, texture	89 RAL 9005  Noir, mat, uni
				

Tous les produits finis/bruts, finissant par -00, peuvent recevoir un revêtement par poudre dans toutes les couleurs RAL disponibles.



DE NOUVEAU DISPONIBLE EN NOIR

DISPONIBLE EN DIFFÉRENTES SURFACES

Black Line est une gamme complète de composants noirs en RAL 9005. Elle peut s'utiliser sur tous les projets de garde-corps. Pincés à verre, adaptateurs à verre, profils de sol pour garde-corps plein en verre, poteaux et main-courantes : tous ces composants sont disponibles dans la gamme Black Line. Fabriqués dans des matériaux de qualité supérieure et bénéficiant d'une finition optimale, tous les composants sont conçus pour être faciles à assembler.



Nettoyage et entretien



L'acier inoxydable est extrêmement résistant à la corrosion et aux rayures grâce à sa composition, mais nécessite de l'entretien, notamment dans les environnements difficiles. Les effets mécaniques et/ou chimiques peuvent également altérer ou détruire la couche passive pendant l'installation. Nous recommandons de traiter toute la surface avec la solution Q-ultra-clean après l'installation pour assurer une couche de passivant solide, une protection durable et une belle finition.

Utilisation	
Q-protector	Inox + aluminium
Q-ultra-clean	Inox
Q-cleaner	Inox (+ aluminium)

Q-protector

Appliquez ce spray offrant une protection durable après avoir installé votre garde-corps en acier inoxydable ou en aluminium. Il permet d'éliminer du garde-corps la poussière et les autres dépôts tout en le protégeant des traces de doigt, de l'humidité et des influences climatiques en créant une couche protectrice sur le matériau. Cerise sur le gâteau : il est inutile d'attendre et de le rincer à l'eau. Q-protector prolonge la durée de vie de votre garde-corps en acier inoxydable ou en aluminium et vous permet de le nettoyer moins souvent.

Q-ultra-clean

Ce spray nettoyant est spécialement conçu pour l'acier inoxydable. Il doit être utilisé après l'assemblage, préventivement ou lorsque la corrosion se produit, car il élimine la saleté persistante et la corrosion de surface. Il renouvelle et renforce également la couche protectrice/passive de l'acier inoxydable.

Q-cleaner

Le Q-cleaner dégraisse et élimine les tâches, les traces de doigts et les autres traces. Il est idéal pour l'utilisation pendant l'assemblage et ainsi que comme nettoyant régulier pour l'entretien de la rambarde.

D'autres matériaux utilisés dans nos produits, comme l'acier et le zamak, peuvent se nettoyer avec de l'eau savonneuse tiède.

Applications des matériaux

Facteurs environnementaux	Applications	Zamak	Aluminium (brossé, anodisé)	Aluminium (brut)	Aluminium (thermolaqué)	Inox 304	Inox 316
Basse	Structures intérieures Hormis dans les espaces humides.	✓	✓	✓	✓	✓	✓
Modérée	Structures intérieures Hormis dans les espaces humides ou fortement chargés en chlore ou dioxyde de soufre (ex. : usines semi-chimiques).	✓	✓	✓	✓	✓	✓
Moyenne	Structures extérieures Dans les espaces modérément chargés en chlore ou dioxyde de soufre (ex. : à au moins 25 km de la côte ou d'autres environnements aquatiques).	!	✓	✗	✗	✗	✓
Élevée	Structures extérieures Dans les espaces susceptibles d'entraîner une forte corrosion due au chlore, au dioxyde de soufre, à une humidité importante ou à l'accumulation de substances nocives (ex. : régions côtières et environnements de piscine).	✗	✓	✗	✗	✗	✓ 

✓ = Adapté

! = Convient, mais nécessite une attention particulière

✗ = Non adapté



PREFIX VOUS SIMPLIFIE LA VIE

La préparation est la clé du succès. Alors pourquoi ne pas économiser votre temps et votre argent en faisant appel à notre service prefix lors de votre prochain achat d'une solution de garde-corps auprès de Q-railing ? Vos articles vous seront livrés prêts à installer.

PREFIX

Options de préfixes disponibles.



Cintrage

Nous pouvons réaliser des opérations de cintrage en 2D ou 3D sur les éléments tubulaires, tubes à fond de gorge, profils en U, profils de protection pour traverses supérieures et même les profils de sol Easy Glass®. Grâce à ce service de qualité, vous recevrez les tailles et courbures exactes que vous avez commandées.



Découpe et fraisage

Pour vous simplifier la vie, vous pouvez nous demander de pré-découper des produits en inox, en aluminium ou en bois. Ce service s'applique aux mains-courantes, tubes à fond de gorge, poteaux et profils de sol Easy Glass®. À réception de vos articles, vous constaterez que les onglets auront été découpés ou les trous fraisés pour permettre l'installation de spots LED, par exemple.



Perçage et taraudage

Lorsque vous aurez essayé notre service de perçage et de taraudage, vous ne pourrez plus vous en passer pour vos achats de poteaux ou de mains-courantes auprès de Q-railing. En appliquant vos spécifications exactes, nous réaliserons tous les trous et filetages nécessaires à l'installation.



Soudure

Nos produits standard ne nécessitent que très rarement d'être soudés pour s'adapter à des configurations particulières. Mais cela n'est pas un problème. Laissez-nous pré-souder vos produits sur mesure et vous les livrer prêts à installer.



Thermolaquage

Ajoutez facilement un thermolaquage lors de votre commande de profils de sol, tubes à fond de gorge, caches pour les extrémités ou pour tout autre produit que vous aimeriez personnaliser avec de la couleur. Sélectionnez la couleur RAL de votre choix.

Pré-assemblage

Pour recevoir des produits Q-railing pré-assemblés selon vos besoins, il vous suffit de commander notre service prefix. Imaginez le gain de temps si vous recevez, par exemple, les supports de vos pinces à verre ou de vos barres transversales déjà montés.

Pour commander des services prefix, il vous suffit de télécharger et de remplir le formulaire de demande Ou contactez-nous. Nos techniciens sera heureux de vous aider.



THERMOLAQUAGE /
CINTRAGE EN 2D



FLOWDRILL

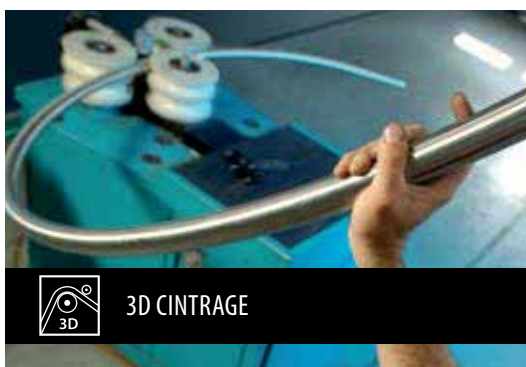

3D CINTRAGE



PERÇAGE



1

SYSTÈMES DE GARDE-CORPS TOUT EN VERRE

Easy Glass® Smart	28 - 49
Easy Glass® Smart+	50 - 61
Easy Glass® Prime	62 - 81
Easy Glass® Strong	82 - 93
Easy Glass® Slim	94 - 103
Easy Glass® Pro	104 - 115
Easy Glass® Max	116 - 125
Easy Glass® Up	126 - 133
Easy Glass® Hybrid	134 - 139
Easy Glass® pinces à verre de sol	140 - 145
Easy Glass® Air	146 - 149
Easy Glass® adaptateurs à verre	150 - 164



Conçu pour : Utilisation faible à résistante
Utilisation : Intérieur et extérieur
Variantes : Montage au sol, latéral et engravé
Applications : Balcons, galeries, passerelles, cloisons, escaliers, pare-vents et protection de fenêtres
Matériau : Aluminium (brossé anodisé, brut et thermolaqué en RAL 9005 noir)
Épaisseur de verre : 12 à 21,52 mm

Retrouvez toutes les informations sur Easy Glass Smart en ligne :



<https://q-ne.ws/Smart23>

EASY GLASS® SMART



red dot winner 2020
innovative product

La facilité d'installation par excellence

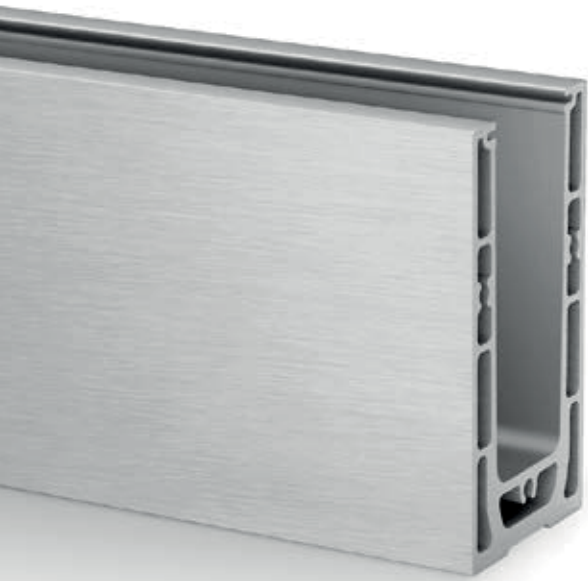

Easy Glass® Smart fonctionne avec le Q-disc® System. L'utilisation conjointe de la cale et de l'inimitable Q-disc garantit une installation du verre extrêmement rapide. Installez le profil de sol, positionnez le verre, puis fixez chaque panneau de verre en toute sécurité et d'un seul geste. La version ajustable du Q-disc System vous permet même d'aligner individuellement chacun des panneaux de verre. Le profil de recouvrement Easy Glass est un accessoire en option assurant une transition harmonieuse avec le sol. Cette finition élégante confère également une plus grande protection aux matériaux du garde-corps. Éligible aux fonctions combinées de garde-corps de grandes hauteurs suivant Avis Technique.

Easy Glass® Smart

Max. charge linéaire (kN/m)

BE

1,0

Tested at
WTCB.be
& CSTC.be

NBN
B03-004

Merci de prendre en considération les spécifications de chaque certificat telles qu'épaisseur du verre, fixation.

Tests/calculs/certificats internationaux:



- 1 Avec le Q-disc System ajustable, vous pouvez aligner individuellement chacun des panneaux de verre jusqu'à 0,6° à la verticale.
- 2 Le Q-disc vous confirme la bonne installation en émettant des « clics » sonores.
- 3 Convient pour des épaisseurs de verre comprises entre 12 et 21,52 mm.

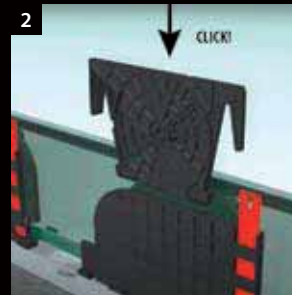
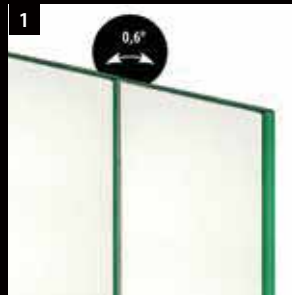

DÉCLINAISONS D'EASY GLASS® SMART

Smart

Montage au sol

- Également pour scellement au sol

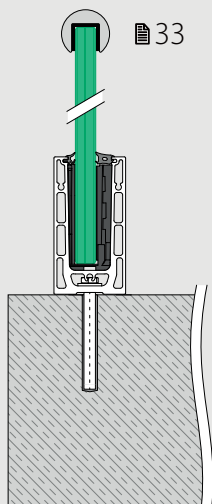

Smart F

Montage au sol

- Pour les sols bruts
- Peut aussi s'installer sur le bord d'une surface ou en débord

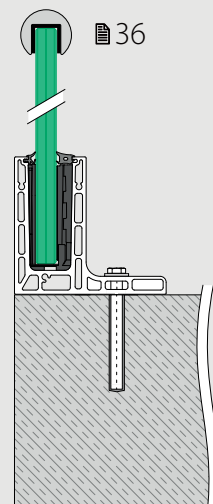

Smart

Montage latéral

- Également pour l'installation sur le côté intérieur des murs de parapet
- Habillages disponibles

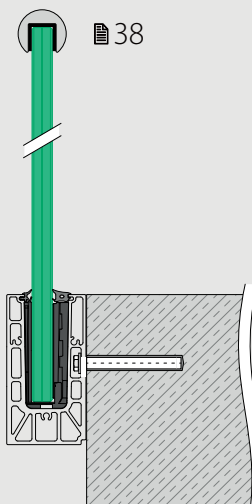

Smart Y

Montage latéral

- Pose latéral
- Peut aussi s'installer sur le bord d'une surface ou en débord
- Habillages disponibles

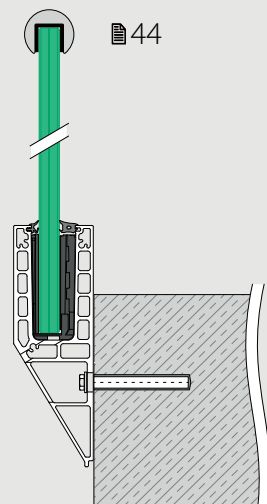



Q-DISC® SYSTEM AJUSTABLE FAITES COULISSER ET ALIGNEZ !



LE PRINCIPE:

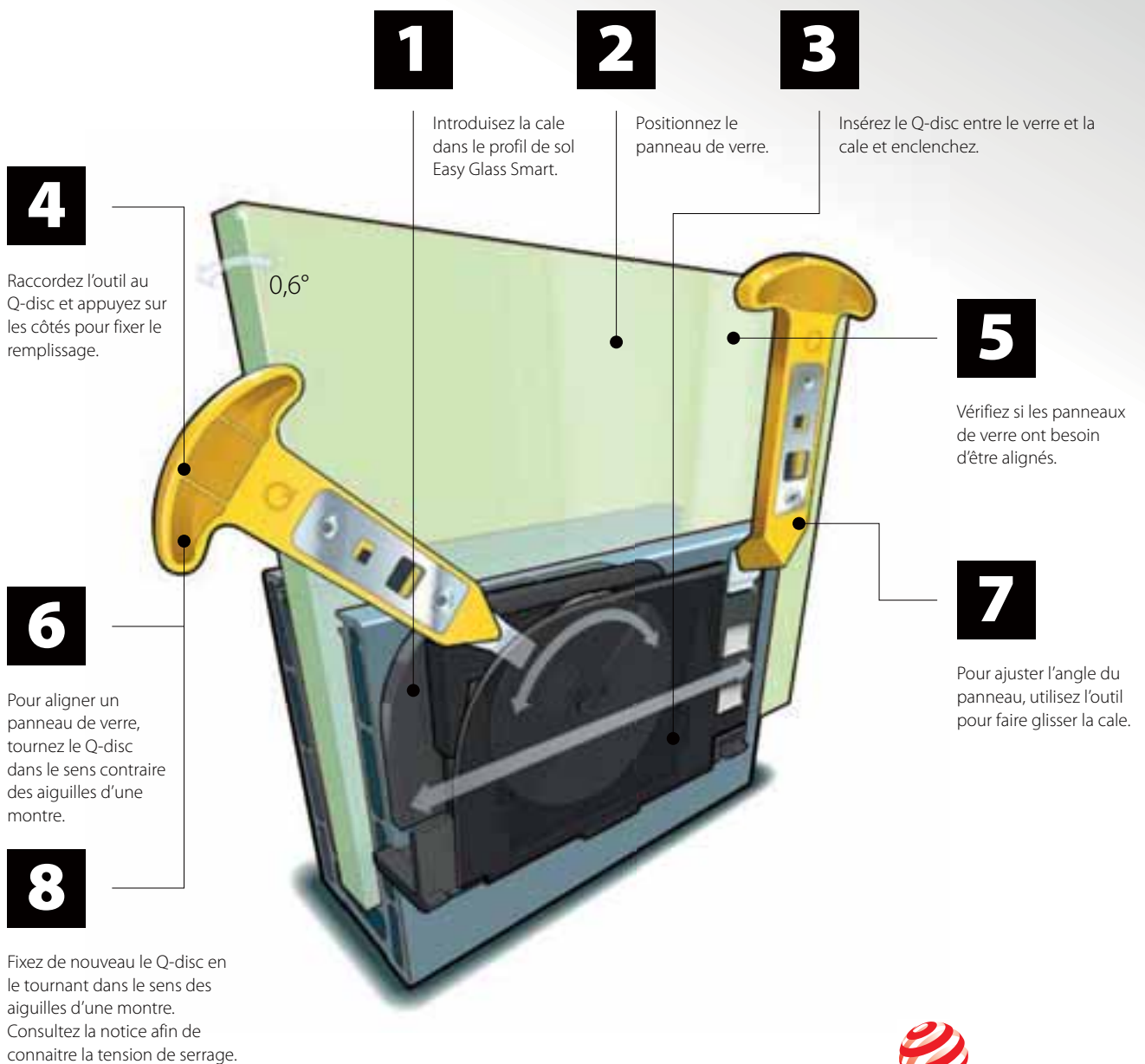

reddot winner 2020
innovative product

Q-disc® System (set de caoutchouc, cale et Q-disc®)

Pour une fixation ajustable du verre

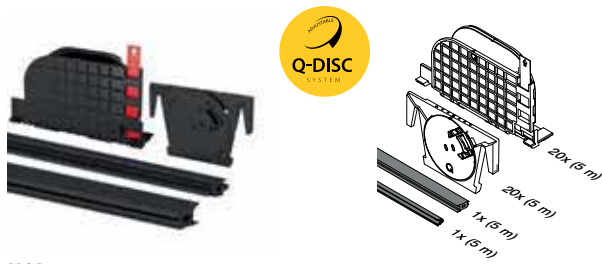

MOD 8201

Accessoires

Pour verre monolithique	T	
208201-050-12	12	L = 5 m
208201-050-15	15	L = 5 m
208201-250-12	12	L = 25 m
208201-250-15	15	L = 25 m

Pour verre feuilleté

208201-050-13	12,76	L = 5 m
208201-050-14	13,52	L = 5 m
208201-050-17	16,76	L = 5 m
208201-050-18	17,52	L = 5 m
208201-250-13	12,76	L = 25 m
208201-250-14	13,52	L = 25 m
208201-250-17	16,76	L = 25 m
208201-250-18	17,52	L = 25 m



International Design Modèle Protection

Accessoires

Outil pour Q-disc® et cale



MOD 1000

Accessoires

	Q	
201000	Q-84	1

Q-INFO MOD 1000

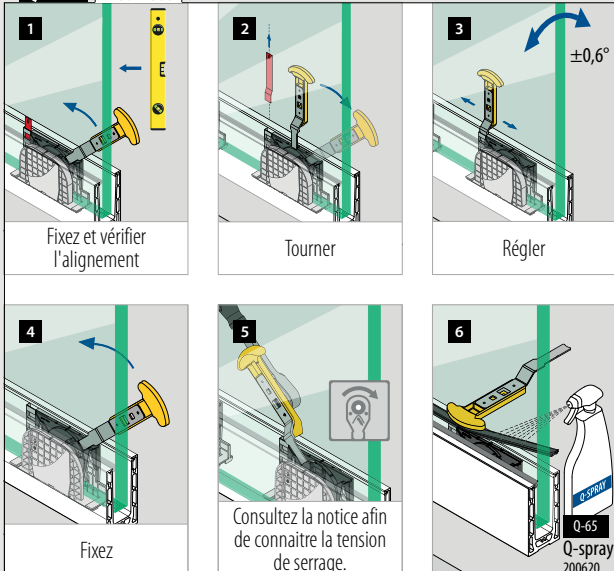

Accessoires

Joint de bourrage seuls



MOD 8207

Accessoires

208207-250-00	L = 25 m
---------------	----------

NEW



MOD 8207

Accessoires

Pour verre monolithique	T	
208207-250-12	12	L = 25 m
208207-250-15	15	L = 25 m

Pour verre feuilleté

208207-250-14	12,76 - 13,52	L = 25 m
208207-250-18	16,76 - 17,52	L = 25 m

NEW

Accessoires

Sets de Q-disc®

Pour une fixation ajustable du verre



MOD 8209

Accessoires

Pour verre monolithique	T	
208209-12	12	5
208209-15	15	5

Pour verre feuilleté

208209-13	12,76	5
208209-14	13,52	5
208209-17	16,76	5
208209-18	17,52	5

NEW



Q-INFO

Guide pour verre

MOD 1002

480



Profil de garde-corps

Q-disc® System (set de caoutchouc, cale et Q-disc®)

Pour une fixation du verre

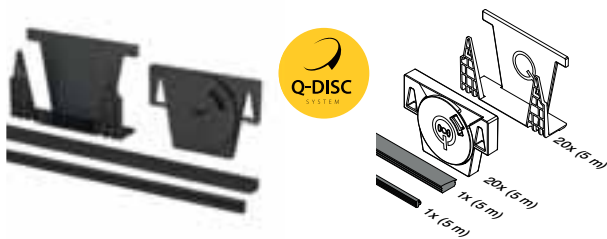

MOD 8200

Accessoires

Pour verre monolithique

T

SELL OUT	208200-050-12	12	L = 5 m
SELL OUT	208200-050-15	15	L = 5 m
SELL OUT	208200-050-19	19	L = 5 m

Pour verre feuilleté

SELL OUT	208200-050-13	12,76 - 13,52	L = 5 m
SELL OUT	208200-050-17	16,76 - 17,52	L = 5 m
SELL OUT	208200-050-21	20,76 - 21,52	L = 5 m

SELL OUT	208200-250-13	12,76 - 13,52	L = 25 m
SELL OUT	208200-250-17	16,76 - 17,52	L = 25 m
SELL OUT	208200-250-21	20,76 - 21,52	L = 25 m



International Design Modèle Protection

Accessoires

Outil pour Q-disc® et cale



MOD 1000

Accessoires

Q

201000	Q-84	1
--------	------	---

Seulement jusqu'à épuisement des stocks.

Q-INFO | MOD 1000

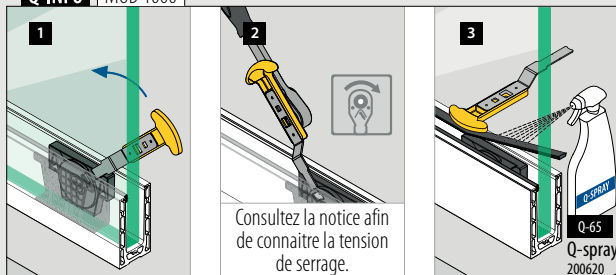

Accessoires

Joint de bourrage seuls



MOD 8206

Accessoires



208206-250-00	L = 25 m
---------------	----------

NEW

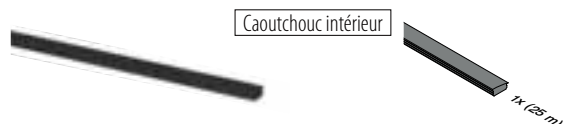

MOD 8206

Accessoires

Pour verre feuilleté

T

208206-250-13	12,76 - 13,52	L = 25 m
208206-250-17	16,76 - 17,52	L = 25 m
208206-250-21	20,76 - 21,52	L = 25 m

NEW

Accessoires

Sets de Q-disc®

Pour une fixation du verre



MOD 8208

Accessoires

Pour verre monolithique

T

208208-12	12	5
208208-15	15	5
208208-19	19	5

Pour verre feuilleté

208208-13	12,76 - 13,52	5
208208-17	16,76 - 17,52	5
208208-21	20,76 - 21,52	5

NEW



Profil de sol, montage au sol

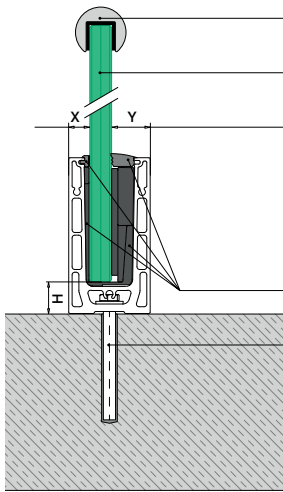

Optionnel :
 Tubes à fond de gorge : ■ 169 - 185
 Profilé de main courante Edge: ■ 166 - 168

Verre de sécurité : ■ 160 - 161

Pour une fixation ajustable du verre
 X = variable
 Y = 25,5
 H = 25

Pour une fixation non ajustable du verre
 X = 15
 Y = variable
 H = 23

Q-disc® System: ■ 31, 32

Fixations : ■ 457 - 463

Merci de prendre en considération les spécifications de chaque certificat telles qu'épaisseur du verre, fixation et types de verre.

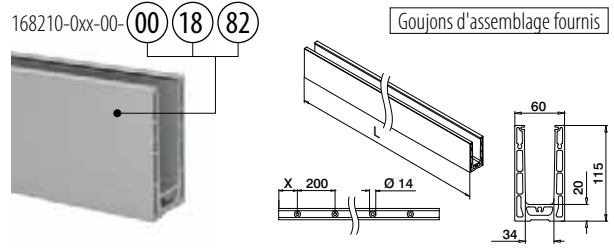

MOD 8210

168210-0xx-00	00	18	82
Aluminium Brut			
	X		
168210-050-00-00	100	■ 457 - 463	L = 5 m
Aluminium Brossé, anodisé			
OUTDOOR			
168210-025-00-18	50	■ 457 - 463	L = 2,5 m
168210-050-00-18	100	■ 457 - 463	L = 5 m
Aluminium Black Line			
OUTDOOR			
NEW 168210-050-00-82	100	■ 457 - 463	L = 5 m



International Design
 Modèle Protection

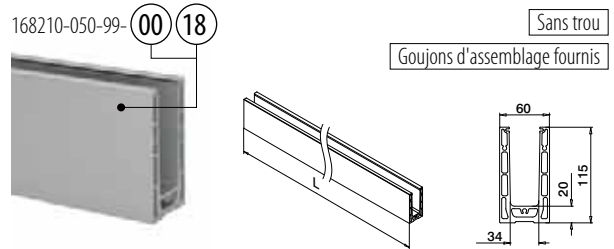

MOD 8210

168210-050-99-00	00	18
Aluminium Brut		
168210-050-99-00		L = 5 m
Aluminium Brossé, anodisé		
OUTDOOR		
168210-050-99-18		L = 5 m



International Design
 Modèle Protection

Q-INFO

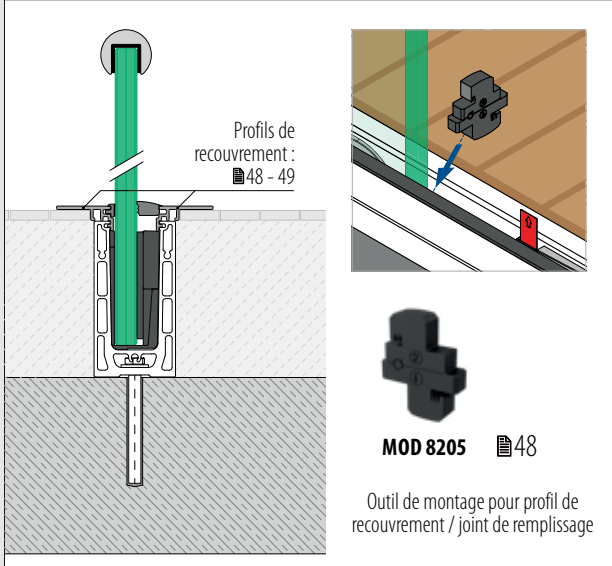

Q-INFO

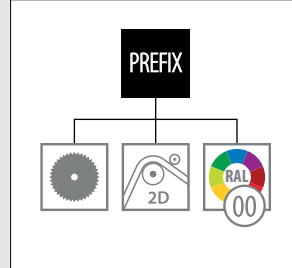

Q-INFO

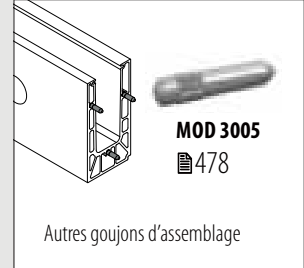

Q-INFO Aluminium

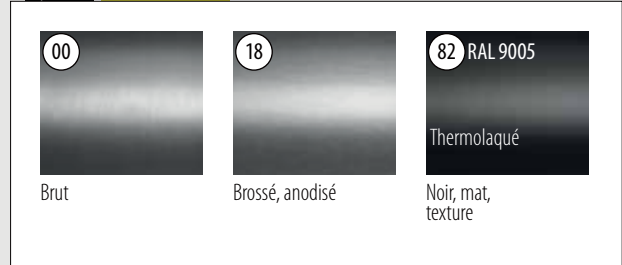

Profil de garde-corps

Angles, montage au sol

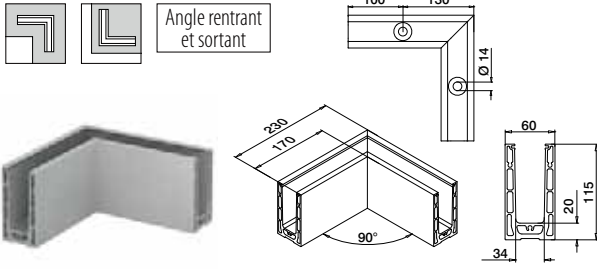

MOD 8211

Aluminium	Brut		
168211-00-00		457 - 463	1
Aluminium	Brossé, anodisé		
OUTDOOR			
168211-00-18		457 - 463	1
Aluminium	Black Line		
OUTDOOR			
NEW 168211-00-82		457 - 463	1



International Design Modèle Protection

Profil de garde-corps

Embouts, montage au sol



MOD 8212

Aluminium	Brut		
Ruban adhésif			
168212-00-00	Fourni		1
Aluminium	Brossé, anodisé		
OUTDOOR			
168212-00-18	Pré-collé		1
Aluminium	Black Line		
OUTDOOR			
NEW 168212-00-82	Fourni		1

Q-INFO MOD 8212

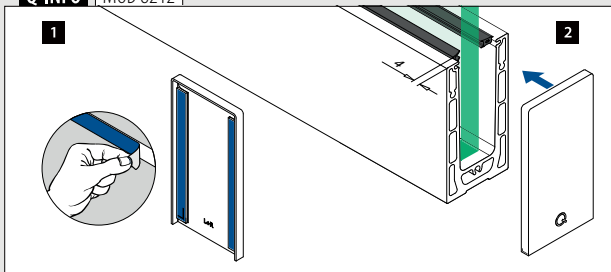

Q-INFO Aluminium

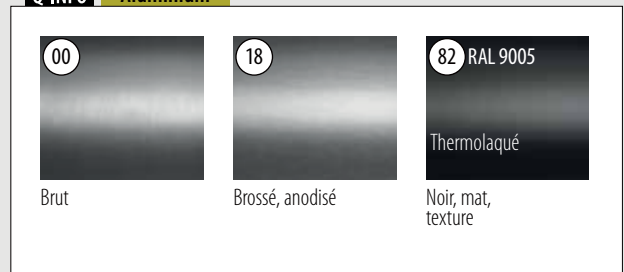

Embouts, montage au sol



Gauche / droite
Pour escaliers

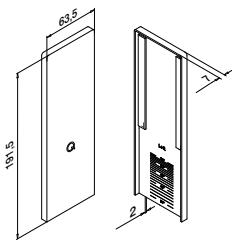

MOD 8213

Aluminium	Brut		
		Ruban adhésif	
168213-00-00	Fourni		1
Aluminium	Brossé, anodisé		
		OUTDOOR	
168213-00-18	Pré-collé		1



Cale, montage au sol

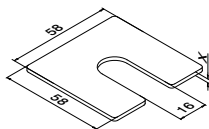

MOD 8216

Aluminium	Brut	X	
168216-001		1	100
168216-002		2	100
168216-003		3	100

Profils de drainage, montage au sol

4 pièces pour un profil de sol de 2,5 mètres
8 pièces pour un profilé de sol de 5 mètres

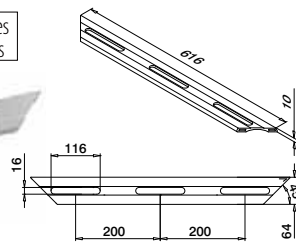

MOD 8217

Aluminium	Brossé, anodisé		
		OUTDOOR	
168217-18			4

Q-INFO MOD 8213

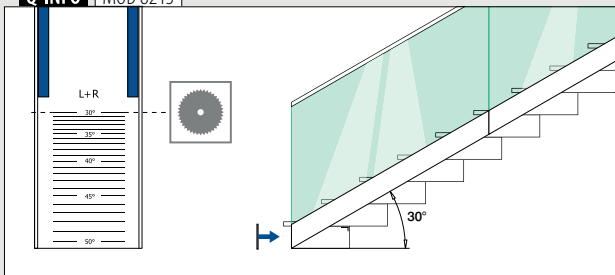

Q-INFO MOD 8216

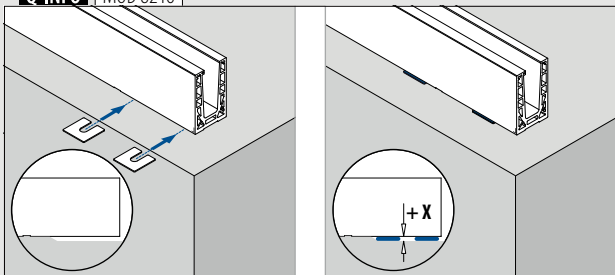

Q-INFO MOD 8217



Profil de garde-corps

Profil de sol, montage au sol

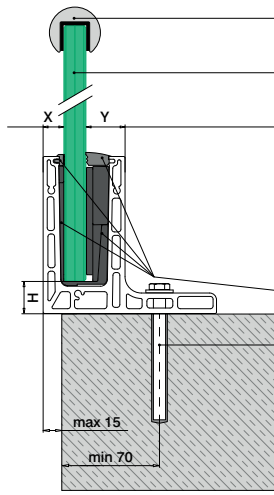

Optionnel :
Tubes à fond de gorge : 169 - 185
Profilé de main courante Edge: 166 - 168

Verre de sécurité : 160 - 161

Pour une fixation ajustable du verre	Pour une fixation non ajustable du verre
X = variable	X = 15,5
Y = 25,5	Y = variable
H = 25	H = 23

Q-disc® System: 31, 32

Fixations : 457 - 463

Merci de prendre en considération les spécifications de chaque certificat telles qu'épaisseur du verre, fixation et types de verre.

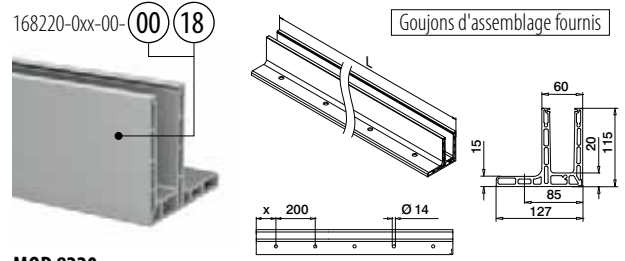

MOD 8220

Aluminium	Brut	X		
168220-050-00-00	100	457 - 463		L = 5 m
Aluminium	Brossé, anodisé	OUTDOOR		
168220-025-00-18	50	457 - 463		L = 2,5 m
168220-050-00-18	100	457 - 463		L = 5 m



International Design
Modèle Protection

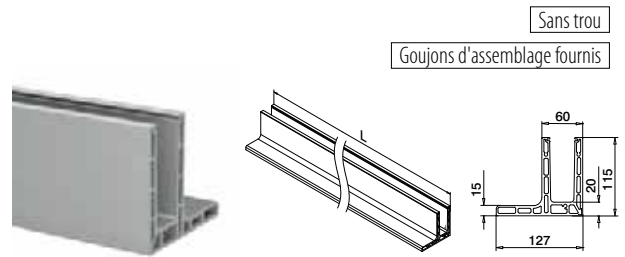

MOD 8220

Aluminium	Brossé, anodisé		
168220-050-99-18			L = 5 m



International Design
Modèle Protection

Q-INFO

Profil de recouvrement : 48 - 49

MOD 8205 48

Outil de montage pour profil de recouvrement / joint de remplissage

Q-INFO

Q-INFO Aluminium

Brut	Brossé, anodisé

Q-INFO

MOD 3005 478

Autres goujons d'assemblage

Angles, montage au sol

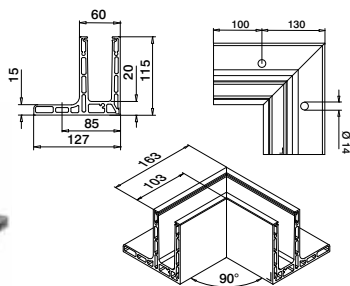

MOD 8221

Aluminium	Brossé, anodisé		
OUTDOOR			
168221-01-18	457 - 463		1



International Design Modèle Protection

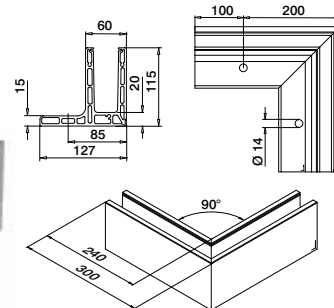

MOD 8221

Aluminium	Brossé, anodisé		
OUTDOOR			
168221-02-18	457 - 463		1



International Design Modèle Protection

Emboutis, montage au sol



Gauche

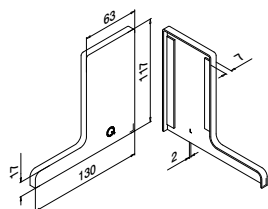

MOD 8222

Aluminium	Brut		
	Ruban adhésif		
168222-01-00	Fourni		1
Aluminium	Brossé, anodisé		
OUTDOOR			
168222-01-18	Pré-collé		1



Droite

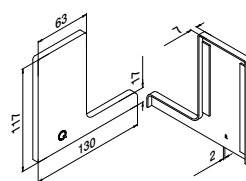

MOD 8222

Aluminium	Brut		
	Ruban adhésif		
168222-02-00	Fourni		1
Aluminium	Brossé, anodisé		
OUTDOOR			
168222-02-18	Pré-collé		1

Profilés de recouvrement étanches, montage au sol

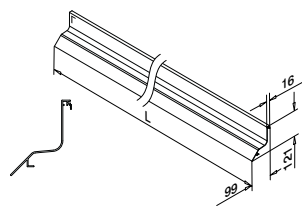

MOD 6980

Aluminium	Brut		
	Ruban adhésif		
166980-50-00	Non compris*		1
Aluminium	Brossé, anodisé		
OUTDOOR			
166980-50-18	Non compris*		1

NEW

*Commander MOD 1360 (ruban adhésif)

Ruban adhésif acrylique



MOD 1360

	Accessoires				
201360	Q-53	9	33 m		1

Q-INFO MOD 8222

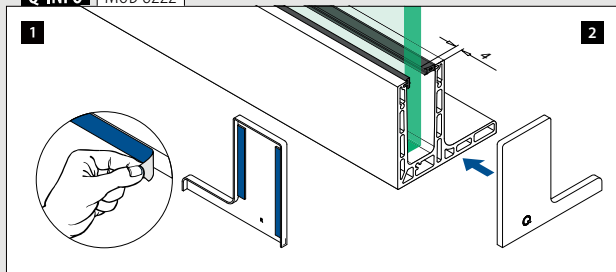

Q-INFO MOD 6980

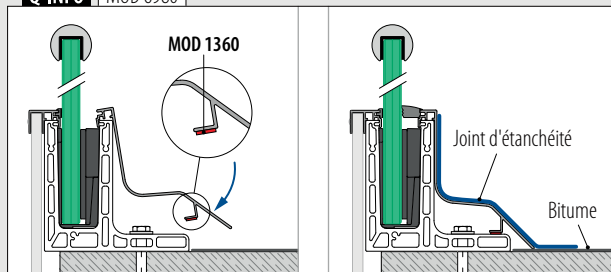

Profil de garde-corps

Profil de sol, montage latéral

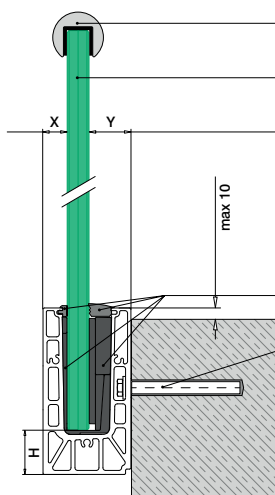

Optionnel :
Tubes à fond de gorge : █ 169 - 185
Profilé de main courante Edge: █ 166 - 168

Verre de sécurité : █ 160 - 161

Pour une fixation ajustable du verre
X = variable
Y = 28,5
H = 35

Pour une fixation non ajustable du verre
X = 18,5
Y = variable
H = 33

Q-disc® System: █ 31, 32

Fixations : █ 457 - 463

Merci de prendre en considération les spécifications de chaque certificat telles qu'épaisseur du verre, fixation et types de verre.

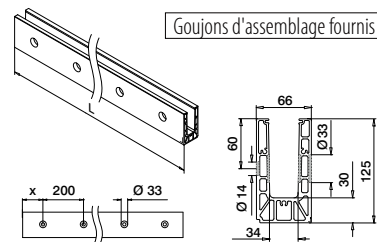

Goujons d'assemblage fournis

MOD 8230

Aluminium	Brut	X	Fixations	L
168230-050-00-00		100	█ 457 - 463	L = 5 m
Aluminium	Brossé, anodisé			
OUTDOOR				
168230-025-00-18		50	█ 457 - 463	L = 2,5 m
168230-050-00-18		100	█ 457 - 463	L = 5 m



International Design
Modèle Protection

Profil de garde-corps

Angles, montage latéral

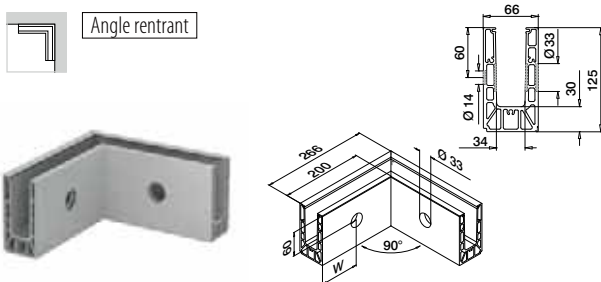

MOD 8231

Aluminium	Brut	W	Fixations	Q
168231-01-00		100*	█ 457 - 463	1
Aluminium	Brossé, anodisé			
OUTDOOR				
168231-01-18		100*	█ 457 - 463	1



International Design Modèle Protection

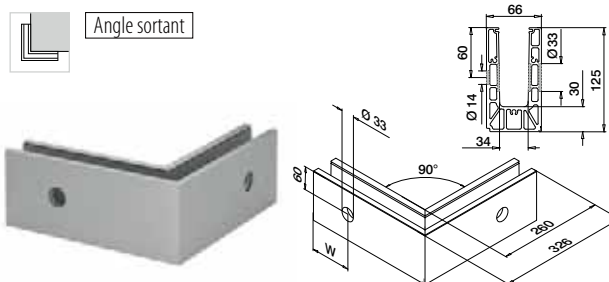

MOD 8231

Aluminium	Brut	W	Fixations	Q
168231-02-00		100*	█ 457 - 463	1
Aluminium	Brossé, anodisé			
OUTDOOR				
168231-02-18		100*	█ 457 - 463	1



International Design Modèle Protection

*La position du trou peut varier en raison de la technique de production.

Q-INFO MOD 8230

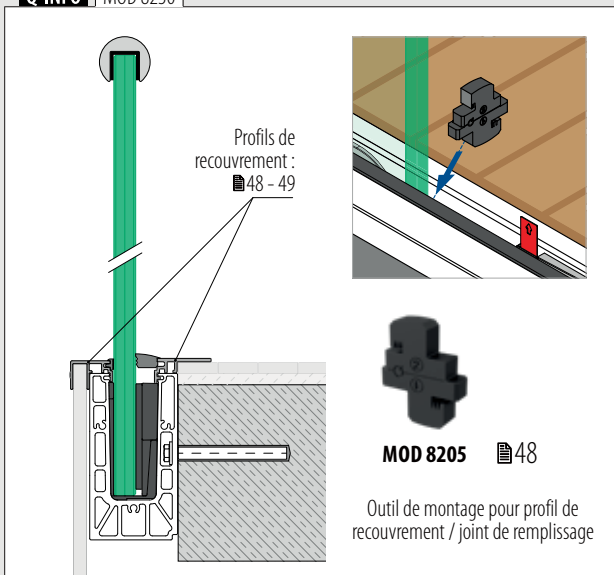

Q-INFO MOD 8230

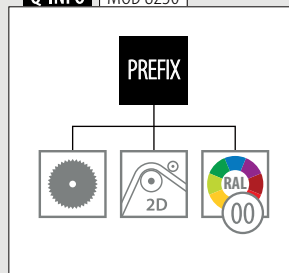

Q-INFO Aluminium



Q-INFO

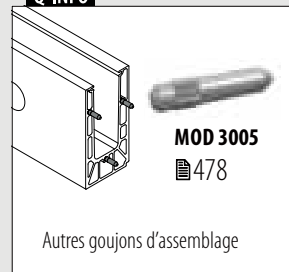

Embouts, montage latéral

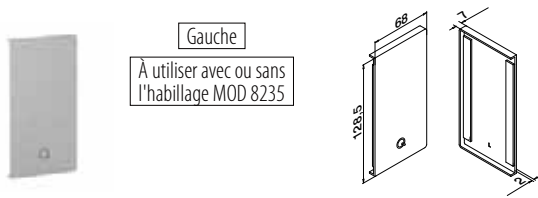

MOD 8232

Aluminium	Brut		
Ruban adhésif			
168232-01-00	Fourni	1	
Aluminium	Brossé, anodisé		
OUTDOOR			
168232-01-18	Pré-collé	1	

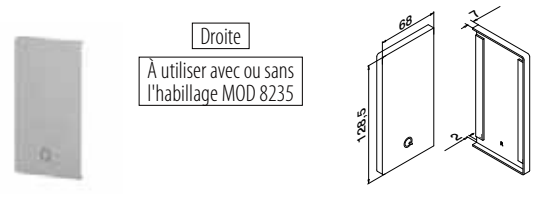

MOD 8232

Aluminium	Brut		
Ruban adhésif			
168232-02-00	Fourni	1	
Aluminium	Brossé, anodisé		
OUTDOOR			
168232-02-18	Pré-collé	1	

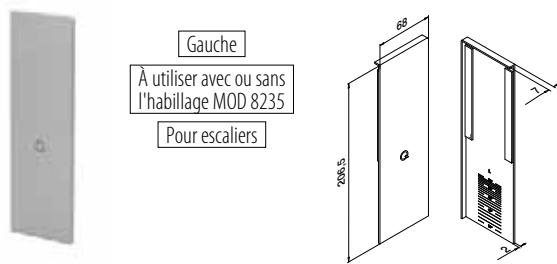

MOD 8233

Aluminium	Brut		
Ruban adhésif			
168233-01-00	Fourni	1	
Aluminium	Brossé, anodisé		
OUTDOOR			
168233-01-18	Pré-collé	1	

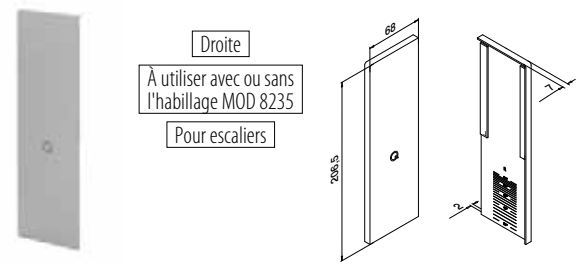

MOD 8233

Aluminium	Brut		
Ruban adhésif			
168233-02-00	Fourni	1	
Aluminium	Brossé, anodisé		
OUTDOOR			
168233-02-18	Pré-collé	1	



Q-INFO Aluminium

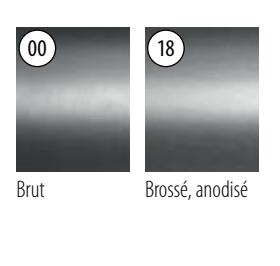

Q-INFO MOD 8232 / 8233

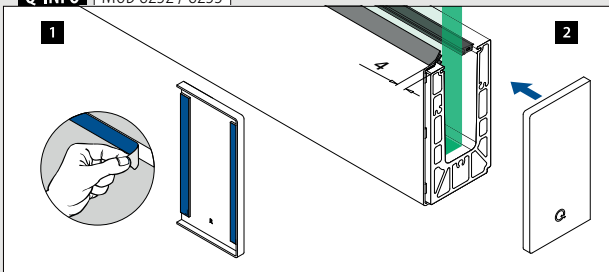

Q-INFO MOD 8233

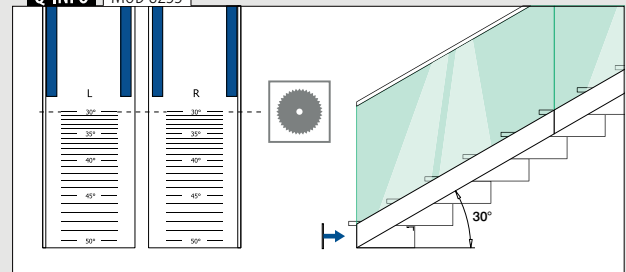

Embouts, montage latéral

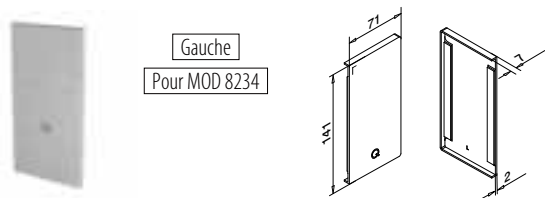

MOD 8232

Aluminium	Brut		
	Ruban adhésif		
168232-41-00	Fourni		1
Aluminium	Brossé, anodisé		
OUTDOOR			
168232-41-18	Pré-collé		1

NEW

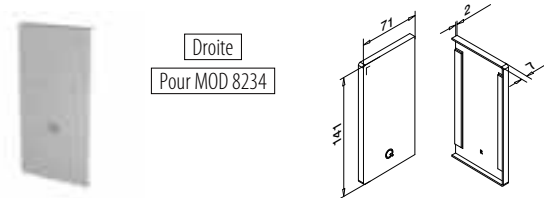

MOD 8232

Aluminium	Brut		
	Ruban adhésif		
168232-42-00	Fourni		1
Aluminium	Brossé, anodisé		
OUTDOOR			
168232-42-18	Pré-collé		1

NEW

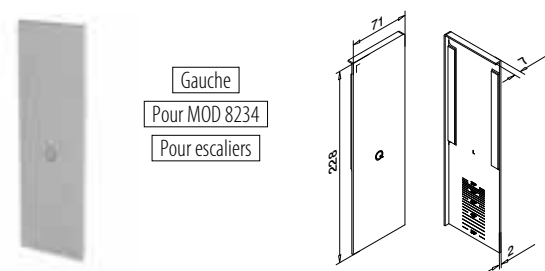

MOD 8233

Aluminium	Brossé, anodisé		
OUTDOOR	Ruban adhésif		
168233-41-18	Pré-collé		1

NEW

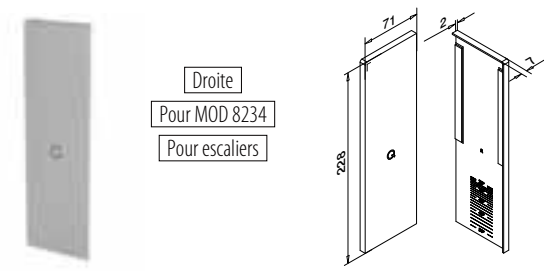

MOD 8233

Aluminium	Brossé, anodisé		
OUTDOOR	Ruban adhésif		
168233-42-18	Pré-collé		1

NEW



Q-INFO Aluminium

00

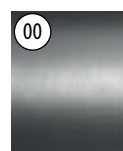

Brut

18



Brossé, anodisé

Profils de drainage, montage latéral

4 pièces pour un profil de sol de 2,5 mètres
8 pièces pour un profilé de sol de 5 mètres

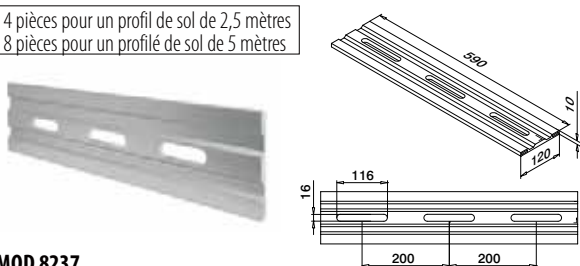

MOD 8237

Aluminium	Brossé, anodisé	
OUTDOOR		
168237-18		4

Embouts, montage latéral

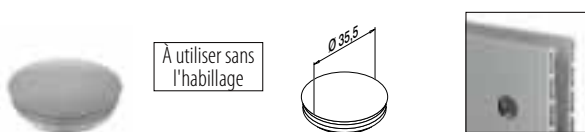

MOD 8238

Plastique	Aluminium blanc RAL 9006	
INDOOR		
158238-36		10

Cale, montage latéral

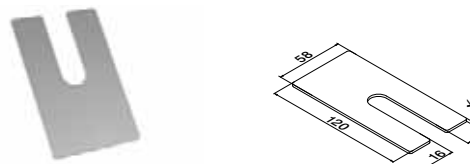

MOD 8236

Aluminium	Brut	
	X	
168236-001	1	100
168236-002	2	100
168236-003	3	100

Butée de verre



MOD 8204

Accessoires		
208204		1

NEW

Q-INFO MOD 8237

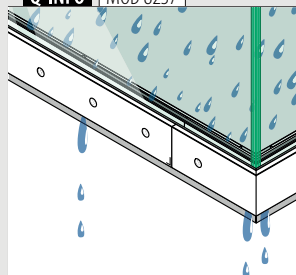

Informations sur l'assemblage :



<https://q-ne.ws/Smart23>

Q-INFO MOD 8238

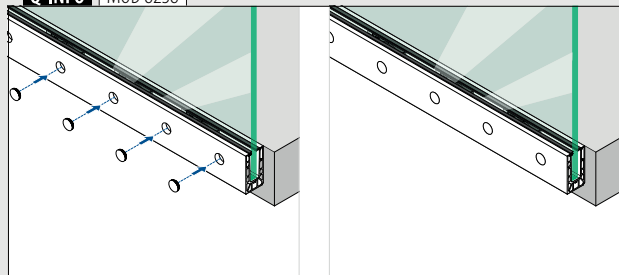

Q-INFO MOD 8236

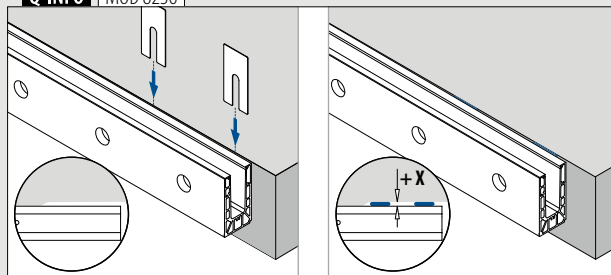

Q-INFO MOD 8204

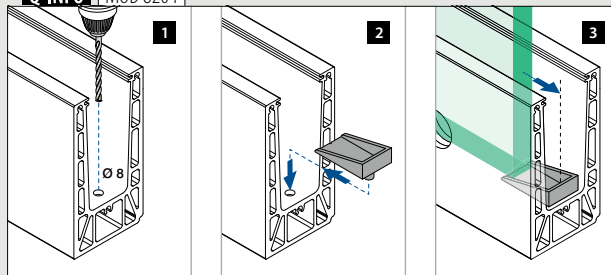

Profil de garde-corps

Habillage, montage latéral

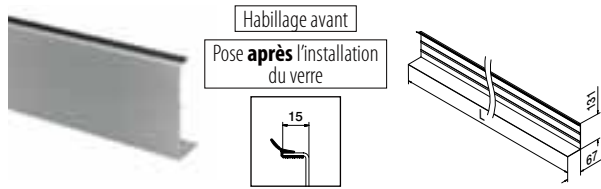

MOD 8235

Aluminium	Brut		
Ruban adhésif			
SELL OUT 168235-050-00	Non compris*	L = 5 m	
Aluminium	Brossé, anodisé		
OUTDOOR			
SELL OUT 168235-050-18	Pré-collé	L = 5 m	



*Commander MOD 1360 (ruban adhésif)

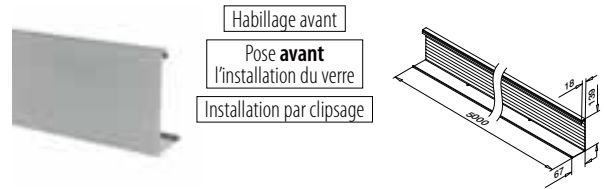

MOD 8234

Aluminium	Brut		
Ruban adhésif			
168234-050-00		L = 5 m	
Aluminium	Brossé, anodisé		
OUTDOOR			
168234-050-18		L = 5 m	



Accessoires

Ruban adhésif acrylique



MOD 1360

Accessoires				
	Q	W	L	
201360	Q-53	9	33 m (pour 11 m d'habillage)	1



Seulement jusqu'à épuisement des stocks.

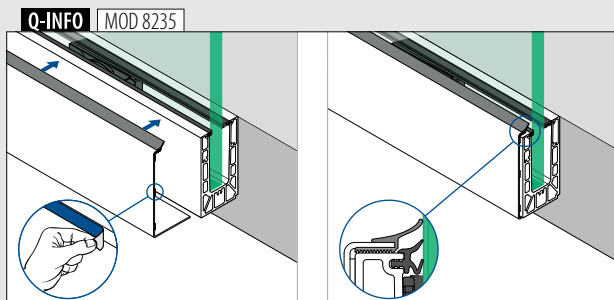

Q-INFO MOD 8235-050-00 / 1360

Informations sur l'assemblage :

<https://q-ne.ws/Smart23>

Q-INFO **Aluminium**

Brut Brossé, anodisé

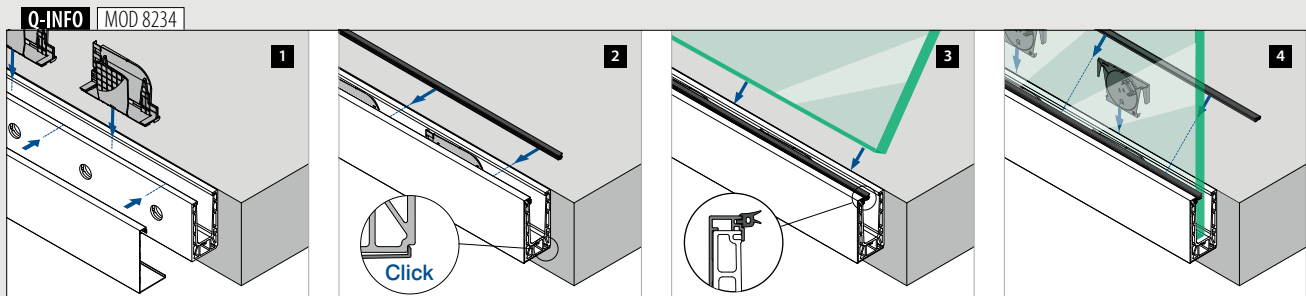



Profil de garde-corps

Profil de sol, montage latéral

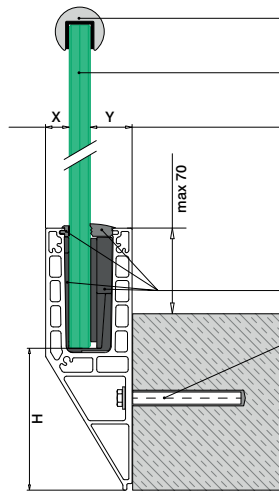

Optionnel :
Tubes à fond de gorge : 169 - 185
Profilé de main courante Edge: 166 - 168

Verre de sécurité : 160 - 161

Pour une fixation ajustable du verre	Pour une fixation non ajustable du verre
X = variable	X = 18,5
Y = 28,5	Y = variable
H = 110	H = 108

Q-disc® System: 31, 32

Fixations : 457 - 463

Merci de prendre en considération les spécifications de chaque certificat telles qu'épaisseur du verre, fixation et types de verre.

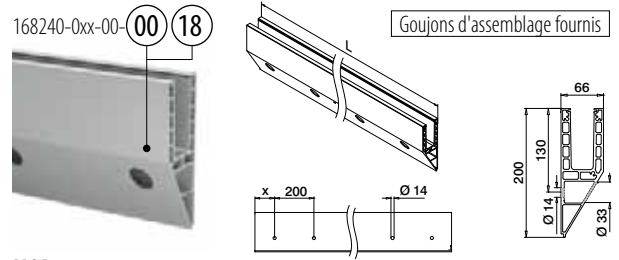

MOD 8240

Aluminium	Brut	X	457 - 463	L = 5 m
168240-050-00-00		100		
Aluminium	Brossé, anodisé	OUTDOOR		
168240-025-00-18		50	457 - 463	L = 2,5 m
168240-050-00-18		100	457 - 463	L = 5 m



International Design
Modèle Protection

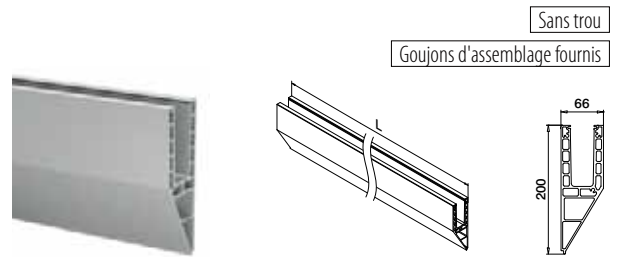

MOD 8240

Aluminium	Brossé, anodisé	Sans trou		
168240-050-99-18		457 - 463		L = 5 m



International Design
Modèle Protection

Q-INFO

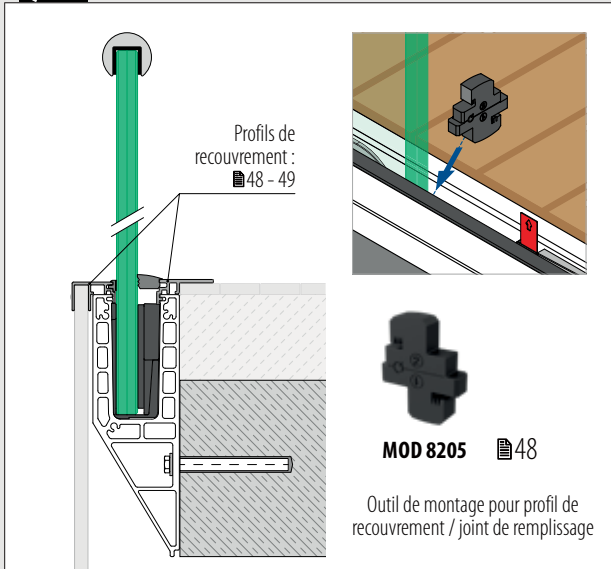

Q-INFO

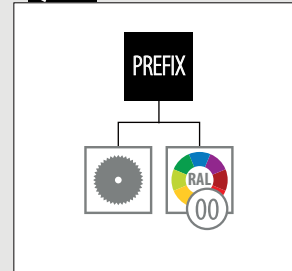

Q-INFO Aluminium

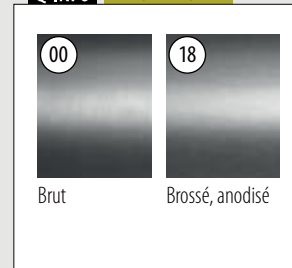

Q-INFO

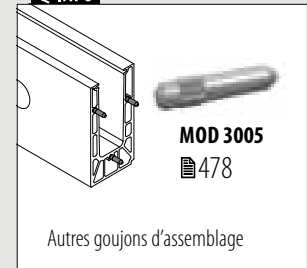

Angles, montage latéral

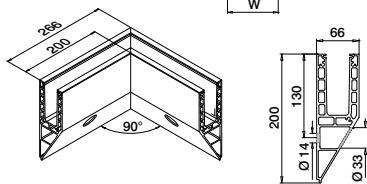

MOD 8241

Aluminium	Brossé, anodisé		
OUTDOOR	W		
168241-01-18	100*	457 - 463	1



International Design Modèle Protection

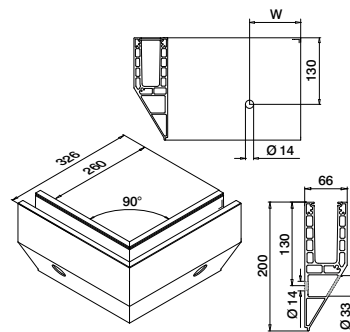

MOD 8241

Aluminium	Brossé, anodisé		
OUTDOOR	W		
168241-02-18	100*	457 - 463	1



International Design Modèle Protection

*La position du trou peut varier en raison de la technique de production.

Embout, montage latéral



Gauche
À utiliser sans l'habillage

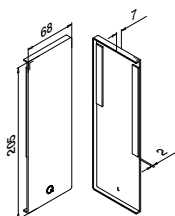

MOD 8242

Aluminium	Brut		
	Ruban adhésif		
168242-01-00	Fourni		1
Aluminium	Brossé, anodisé		
OUTDOOR			
168242-01-18	Pré-collé		1



Droite
À utiliser sans l'habillage

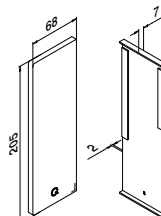

MOD 8242

Aluminium	Brut		
	Ruban adhésif		
168242-02-00	Fourni		1
Aluminium	Brossé, anodisé		
OUTDOOR			
168242-02-18	Pré-collé		1



Gauche
À utiliser avec ou sans l'habillage MOD 8245
Pour escaliers

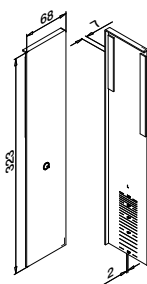

MOD 8243

Aluminium	Brossé, anodisé		
OUTDOOR	Ruban adhésif		
168243-01-18	Pré-collé		1



Droite
À utiliser avec ou sans l'habillage MOD 8245
Pour escaliers

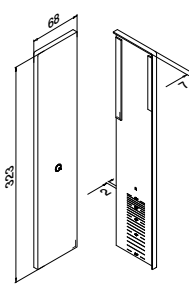

MOD 8243

Aluminium	Brossé, anodisé		
OUTDOOR	Ruban adhésif		
168243-02-18	Pré-collé		1



Q-INFO MOD 8242 / 8243

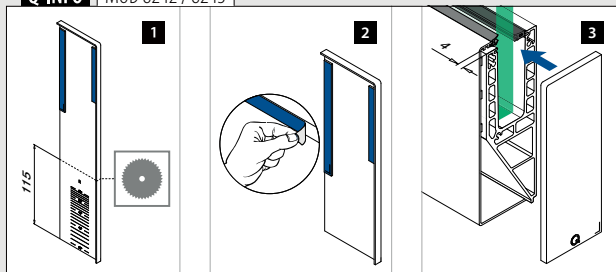

Q-INFO MOD 8243

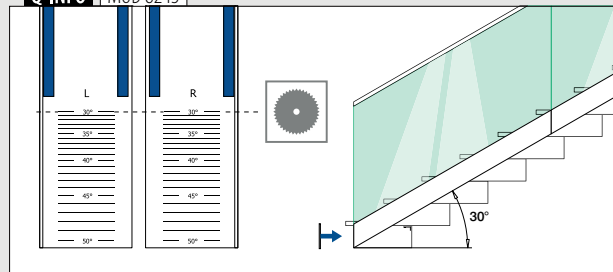

Profil de garde-corps

Embouts, montage latéral

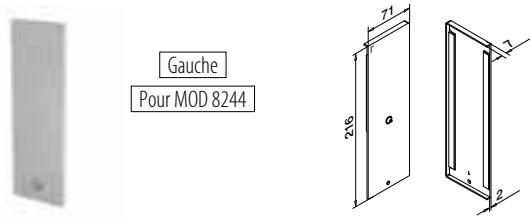

Gauche
Pour MOD 8244

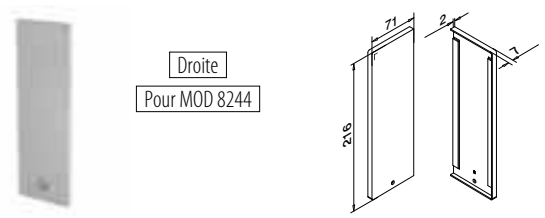

Droite
Pour MOD 8244

MOD 8242

Aluminium	Brut		
	Ruban adhésif		
168242-41-00	Fourni	1	
Aluminium	Brossé, anodisé		
OUTDOOR			
168242-41-18	Pré-collé	1	

NEW

MOD 8242

Aluminium	Brut		
	Ruban adhésif		
168242-42-00	Fourni	1	
Aluminium	Brossé, anodisé		
OUTDOOR			
168242-42-18	Pré-collé	1	

NEW

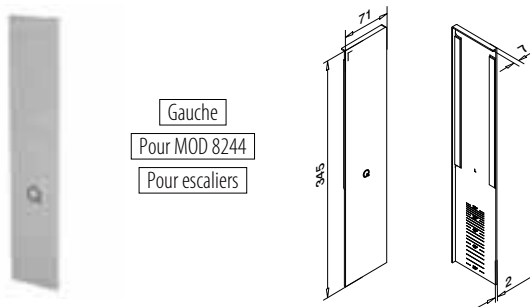

Gauche
Pour MOD 8244
Pour escaliers

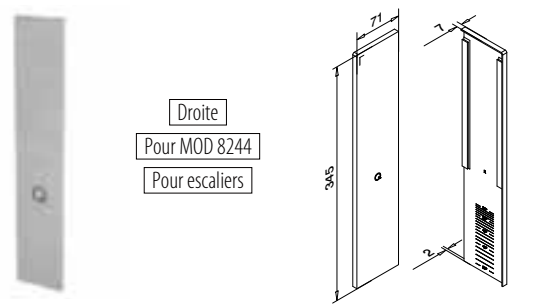

Droite
Pour MOD 8244
Pour escaliers

MOD 8243

Aluminium	Brossé, anodisé		
OUTDOOR	Ruban adhésif		
168243-41-18	Pré-collé	1	

NEW



MOD 8243

Aluminium	Brossé, anodisé		
OUTDOOR	Ruban adhésif		
168243-42-18	Pré-collé	1	

NEW



Profil de garde-corps

Butée de verre



Pour escaliers

MOD 8204

Accessoires			
208204	1		

NEW

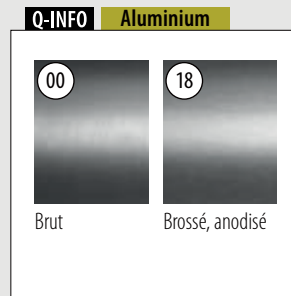
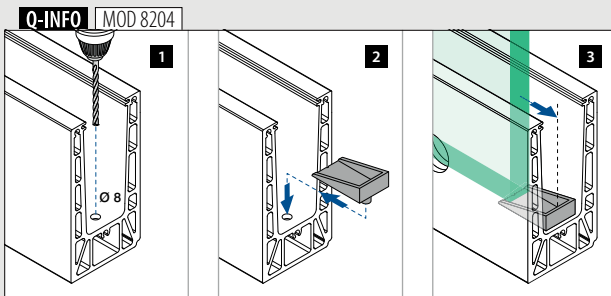

Habillage, montage latéral

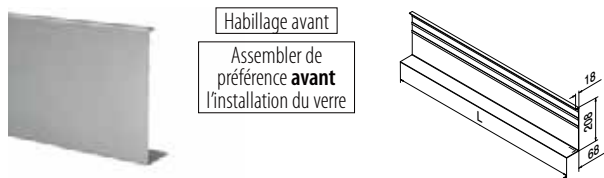

MOD 8245

Aluminium	Brut		
Ruban adhésif			
SELL OUT 168245-050-00	Non compris*	L = 5 m	
Aluminium	Brossé, anodisé		
OUTDOOR			
SELL OUT 168245-050-18	Pré-collé	L = 5 m	



*Commander MOD 1360 (ruban adhésif)

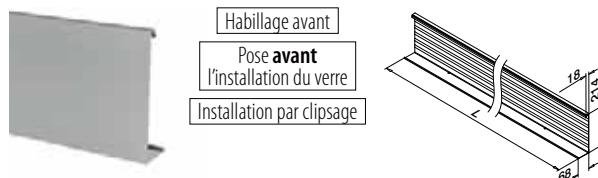

MOD 8244

Aluminium	Brut		
Ruban adhésif			
168244-050-00		L = 5 m	
Aluminium	Brossé, anodisé		
OUTDOOR			
168244-050-18		L = 5 m	



Accessoires

Ruban adhésif acrylique



MOD 1360

Accessoires				
	Q	W	L	
201360	Q-53	9	33 m (pour 11 m d'habillage)	1

Q-INFO MOD 8245-050-00 / 1360

Informations sur l'assemblage :



SELL OUT Seulement jusqu'à épuisement des stocks.

Q-INFO MOD 8245

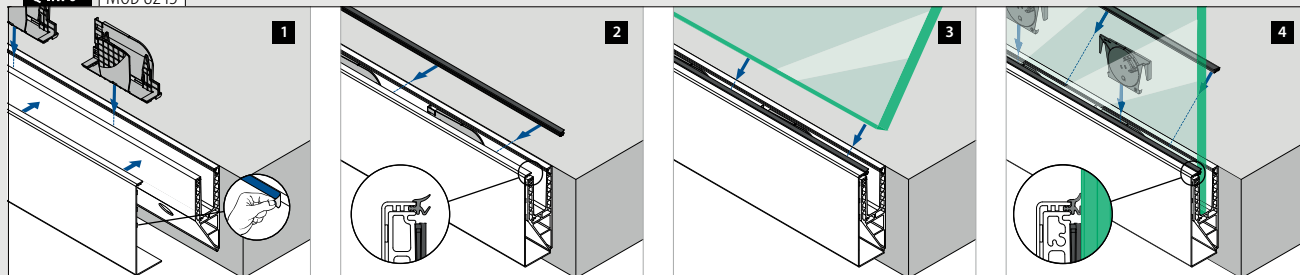

Q-INFO MOD 8244

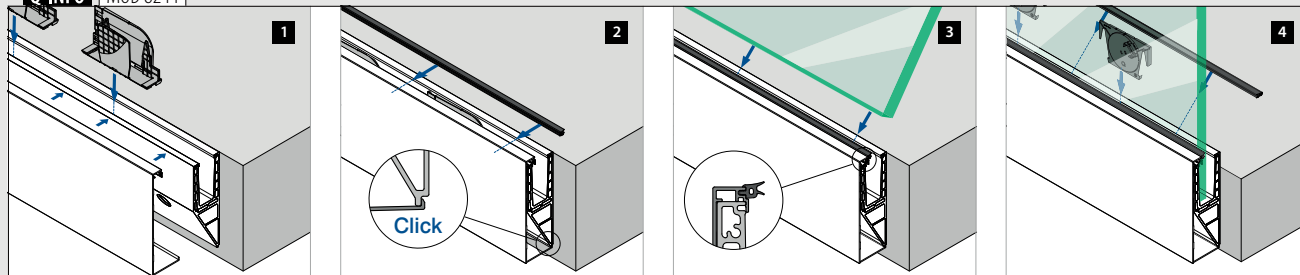

Profil de garde-corps

Profils de recouvrement, montage au sol

Pour tous les profils Smart

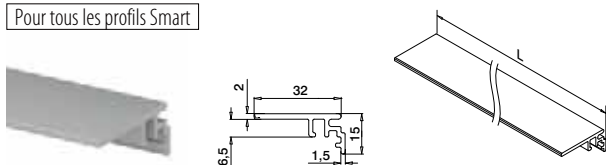

MOD 6973

Aluminium	Brut	
166973-50-00	L = 5 m	
Aluminium	Brossé, anodisé	
OUTDOOR		
166973-50-18	L = 5 m	

PREFIX

Pour les profils Smart
au sol et profils en F

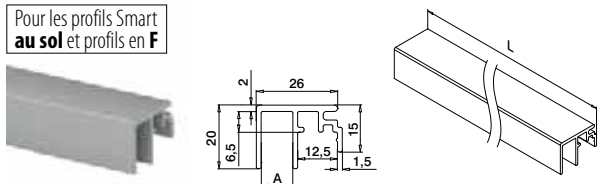

MOD 6972

Aluminium	Brut	
	A	
166972-010-50-00	10	L = 5 m
Aluminium	Brossé, anodisé	
OUTDOOR		
166972-010-50-18	10	L = 5 m

PREFIX

Pour tous les profils Smart

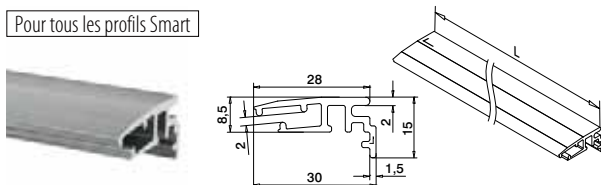

MOD 6979

Aluminium	Brut	
166979-002-50-00	L = 5 m	
Aluminium	Brossé, anodisé	
OUTDOOR		
166979-002-50-18	L = 5 m	

NEW

PREFIX

Pour les profils Smart
au sol et profils en F

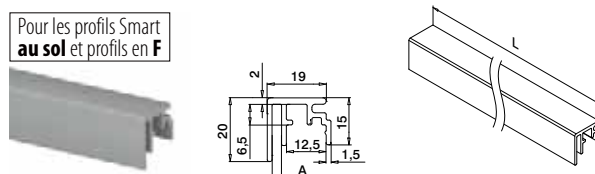

MOD 6972

Aluminium	Brut	
	A	
166972-003-50-00	3	L = 5 m
Aluminium	Brossé, anodisé	
OUTDOOR		
166972-003-50-18	3	L = 5 m

PREFIX

Pour les profils Smart
au sol et profils en F

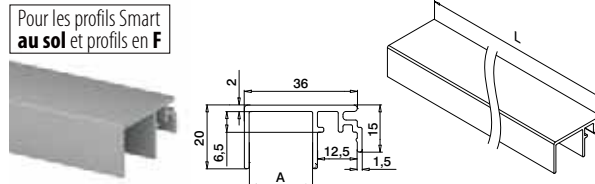

MOD 6972

Aluminium	Brut	
	A	
166972-020-50-00	20	L = 5 m
Aluminium	Brossé, anodisé	
OUTDOOR		
166972-020-50-18	20	L = 5 m

PREFIX

Profil de garde-corps

Outil de montage pour profil de recouvrement / joint de remplissage



MOD 8205

Accessoires	
208205-010	5



Q-INFO Aluminium

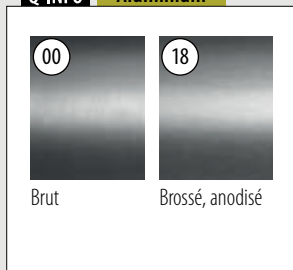

Q-INFO

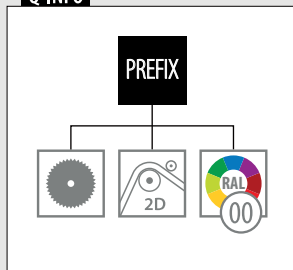

Q-INFO MOD 8205

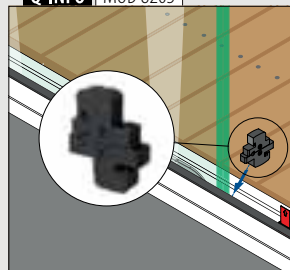

Profils de recouvrement, montage latéral

Pour tous les profils Smart

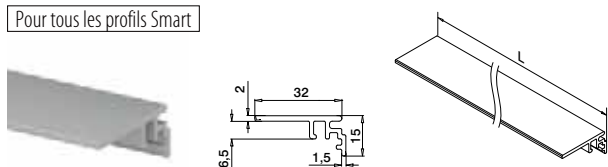

MOD 6973

Aluminium	Brut		
166973-50-00		L = 5 m	
Aluminium	Brossé, anodisé		
OUTDOOR			
166973-50-18		L = 5 m	

PREFIX

Pour les profils Smart latéral et profils en Y

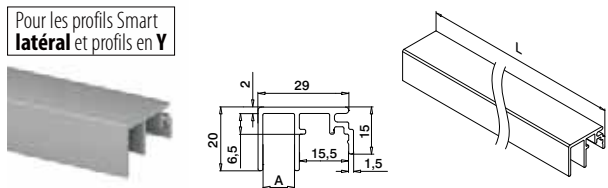

MOD 6970

Aluminium	Brut	A	
166970-010-50-00		10	L = 5 m
Aluminium	Brossé, anodisé		
OUTDOOR			
166970-010-50-18		10	L = 5 m

PREFIX

Pour les profils Smart latéral et profils en Y

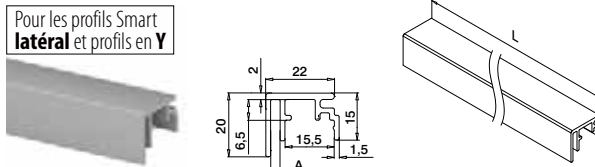

MOD 6970

Aluminium	Brut	A	
166970-003-50-00		3	L = 5 m
Aluminium	Brossé, anodisé		
OUTDOOR			
166970-003-50-18		3	L = 5 m

PREFIX

Pour les profils Smart latéral et profils en Y

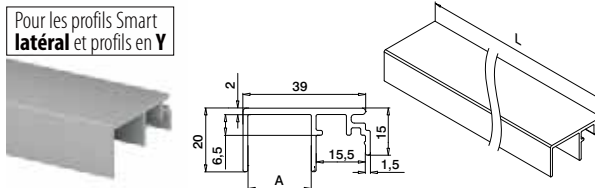

MOD 6970

Aluminium	Brut	A	
166970-020-50-00		20	L = 5 m
Aluminium	Brossé, anodisé		
OUTDOOR			
166970-020-50-18		20	L = 5 m

PREFIX

Q-INFO MOD 6979

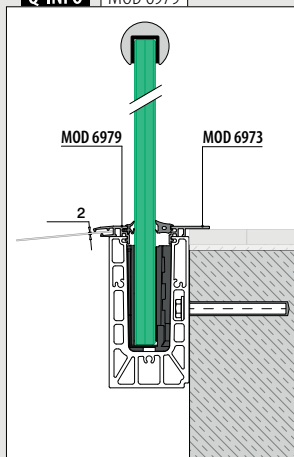

Q-INFO MOD 6972-010 / 6973

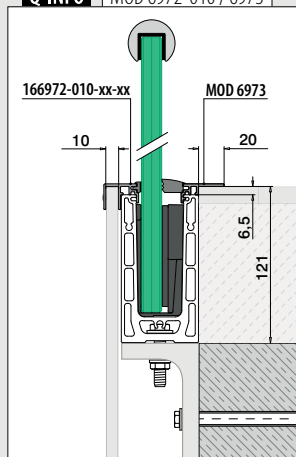

Q-INFO MOD 6972-020 / 6973

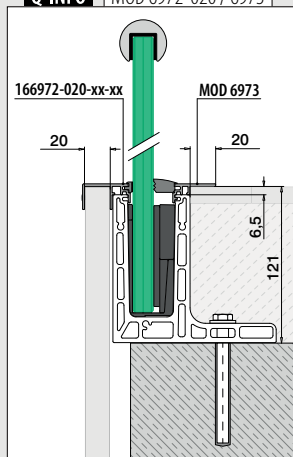

Q-INFO MOD 6970-010 / 6973

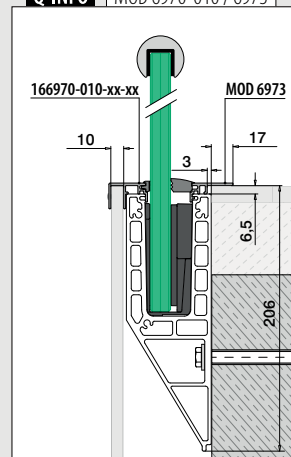



Conçu pour : Utilisation faible à résistante
Utilisation : Intérieur et extérieur
Variantes : Montage au sol, latéral et engravé
Applications : Balcons, galeries, passerelles, cloisons, escaliers, pare-vents et protection de fenêtres
Matériau : Aluminium (brossé anodisé et brut)
Épaisseur de verre : 16,76 à 21,52 mm

Retrouvez toutes les informations sur Easy Glass Smart+ en ligne :



<https://q-ne.ws/SmartPlus23>

EASY GLASS® SMART+



red dot winner 2020
innovative product

Pose rapide et facile de verre de 16,76 - 21,52 mm d'épaisseur

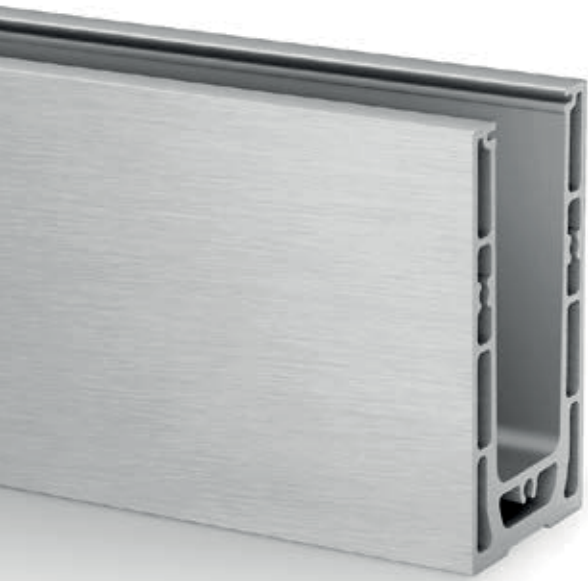

Vous recherchez une solution qui vous permet d'installer rapidement du verre feuilleté de 16,76 - 21,52 mm d'épaisseur et d'aligner chaque panneau de verre individuellement ? Easy Glass® Smart+ est fait pour vous. Comme avec Easy Glass® Smart, il vous suffit de poser le profil de sol, de positionner le verre et, d'un simple mouvement de la main, d'aligner solidement chaque panneau et de le fixer en toute sécurité.

Easy Glass® Smart+

Max. charge linéaire (kN/m)

BE

1,0

Tested at
WTCB.be
& CSTC.be

NBN
803-004

Merci de prendre en considération les spécifications de chaque certificat telles qu'épaisseur du verre, fixation.

Tests/calculs/certificats internationaux:



- 1 Avec le Q-disc System ajustable, vous pouvez réaligner individuellement chacun des panneaux de verre jusqu'à 0,6° à la verticale.
- 2 Le Q-disc vous confirme la bonne installation en émettant des « clics » sonores.
- 3 Adapté au verre feuilleté d'une épaisseur de 16,76 - 21,52 mm.

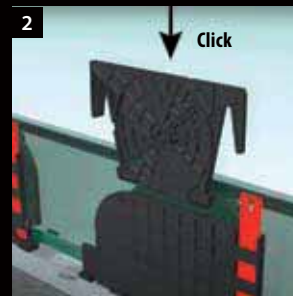
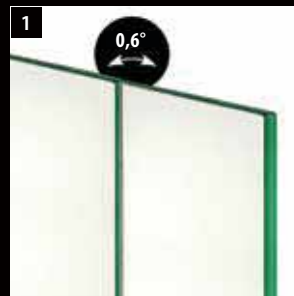

DÉCLINAISONS D'EASY GLASS® SMART+

Smart+

Montage au sol

- Également pour scellement au sol

Smart+

Montage latéral

- Également pour l'installation sur le côté intérieur des murs de parapet
- Habillages disponibles

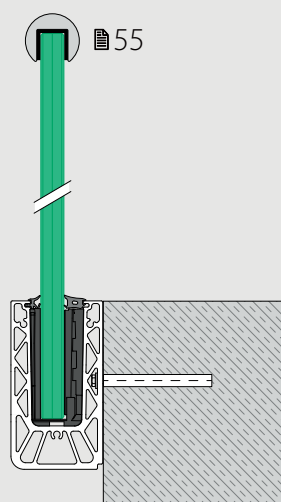
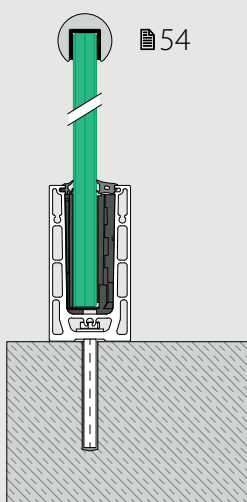

COMING SOON

F et Y profils de sol

Smart+ F

Montage au sol

- Pour les sols bruts
- Peut aussi s'installer sur le bord d'une surface ou en débord

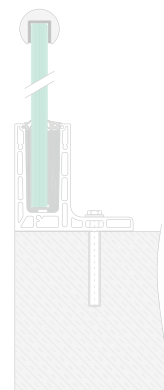

Smart+ Y

Montage latéral

- Pose latéral
- Peut aussi s'installer sur le bord d'une surface ou en débord

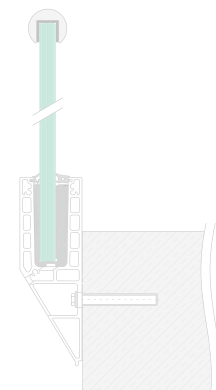



Q-DISC® SYSTEM AJUSTABLE FAITES COULISSER ET ALIGNEZ !



LE PRINCIPE:

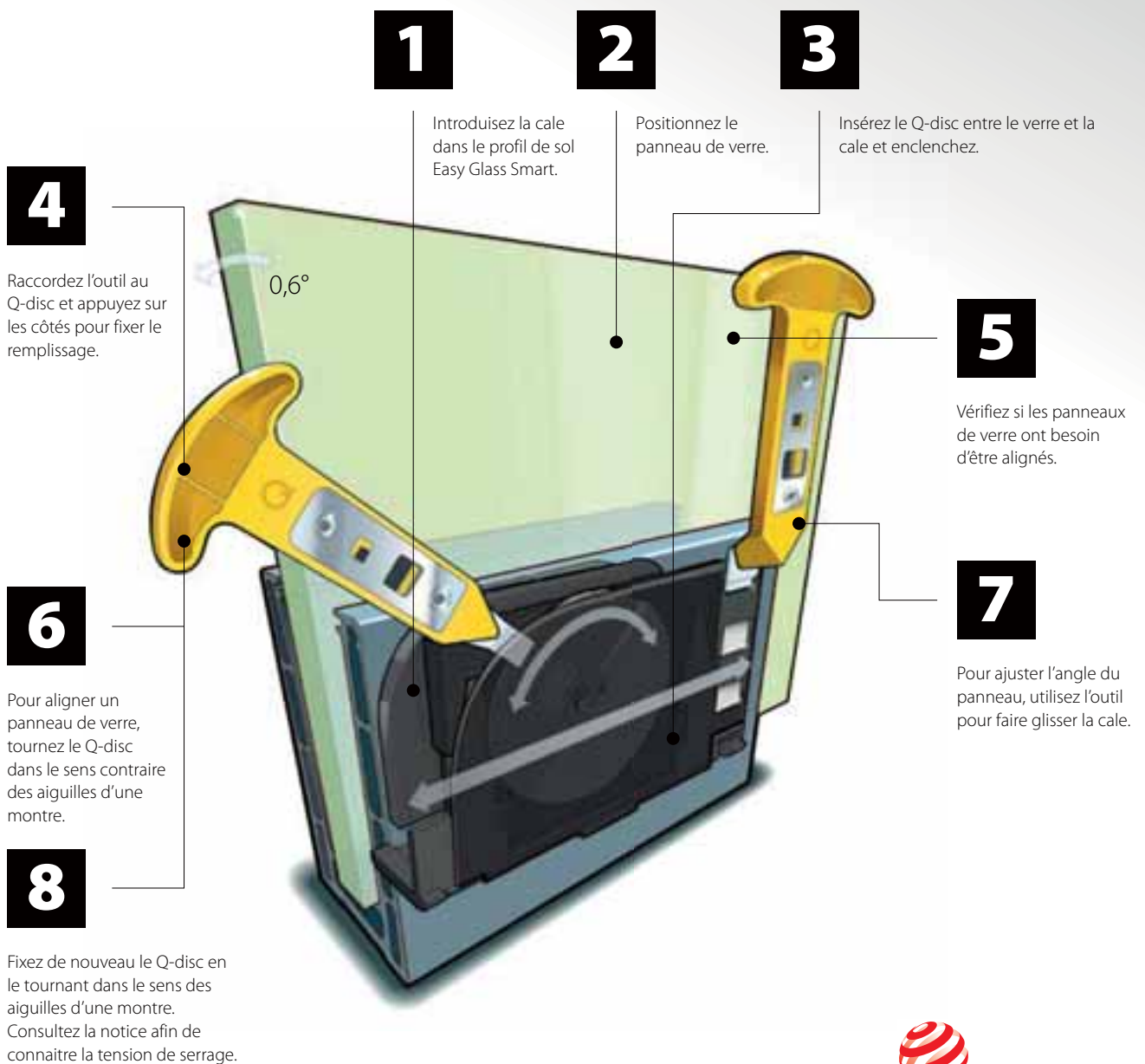

reddot winner 2020
innovative product

Q-disc® System (set de caoutchouc, cale et Q-disc®)

Pour une fixation ajustable du verre

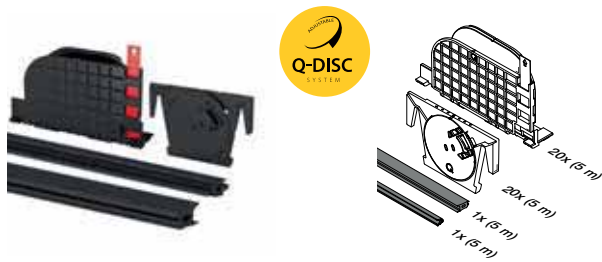

MOD 8301

Accessoires

Pour verre feuilleté	T	
208301-050-17	16,76	L = 5 m
208301-050-18	17,52	L = 5 m
208301-050-22	21,52	L = 5 m
208301-250-17	16,76	L = 25 m
208301-250-18	17,52	L = 25 m
208301-250-22	21,52	L = 25 m



International Design Modèle Protection

Accessoires

Outil pour Q-disc® et cale



MOD 1000

Accessoires

	Q	
201000	Q-84	1

Accessoires

Joint de bourrage seuls



MOD 8207

Accessoires

208207-250-00		L = 25 m
---------------	-------------------------------------------------------------------------------------	----------

NEW

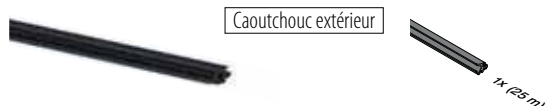

MOD 8207

Accessoires

Pour verre feuilleté	T	
208207-250-14	16,76 - 17,52	L = 25 m
208207-250-18	21,52	L = 25 m

NEW

Accessoires

Sets de Q-disc®

Pour une fixation ajustable du verre



MOD 8309

Accessoires

Pour verre feuilleté	T	
208309-17	16,76	5
208309-18	17,52	5
208309-22	21,52	5

NEW



Q-INFO MOD 1000

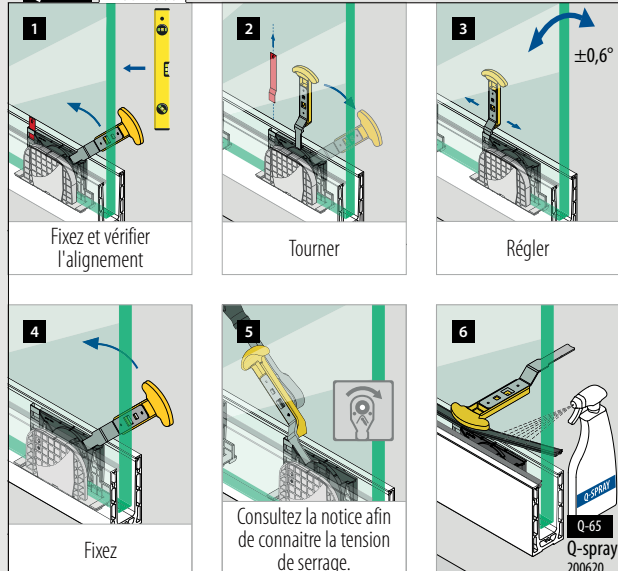

Q-INFO

Guide pour verre

MOD 1002

 480



Profil de garde-corps

Profil de sol, montage au sol

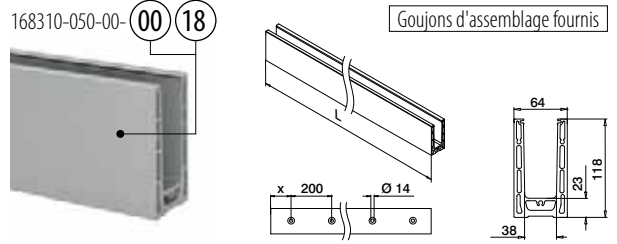
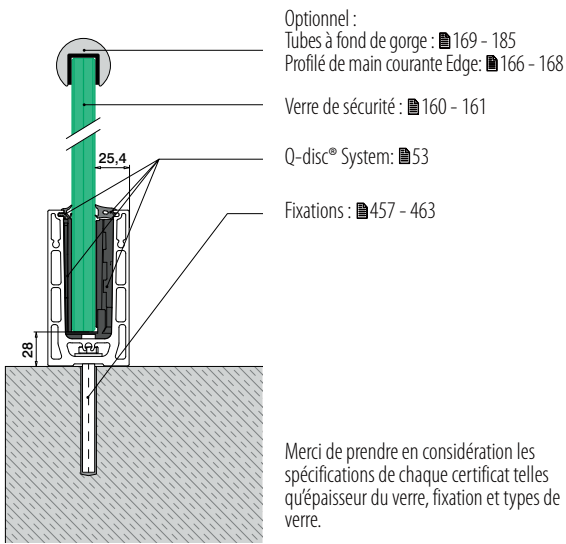

MOD 8310

Aluminium	Brut	X	■ 457 - 463	L = 5 m
168310-050-00-00	100			
Aluminium	Brossé, anodisé	OUTDOOR		
168310-025-00-18	50		■ 457 - 463	L = 2,5 m
168310-050-00-18	100		■ 457 - 463	L = 5 m



International Design
Modèle Protection

Profil de garde-corps

Angles, montage au sol

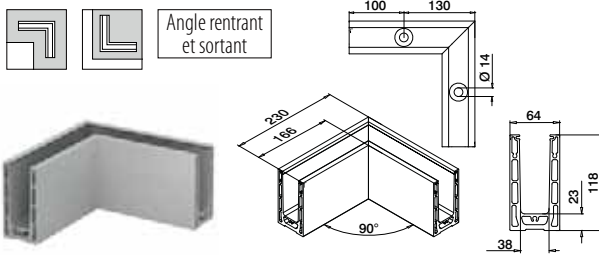

MOD 8311

Aluminium	Brut	■ 457 - 463	1
168311-00-00			
Aluminium	Brossé, anodisé	OUTDOOR	
168311-00-18		■ 457 - 463	1



International Design Modèle Protection

Profil de garde-corps

Embout, montage au sol



MOD 8312

Aluminium	Brut	Ruban adhésif	■
168312-00-00	Fourni		1
Aluminium	Brossé, anodisé	OUTDOOR	
168312-00-18	Pré-collé		1



Q-INFO MOD 8310

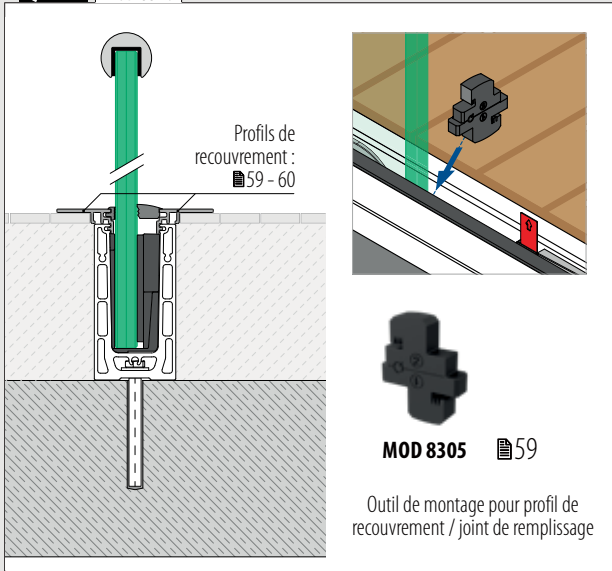

Q-INFO MOD 8310

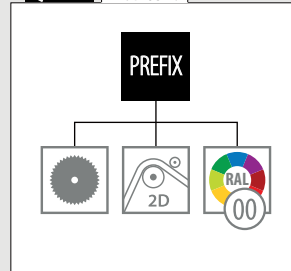

Q-INFO MOD 8310 / 8311

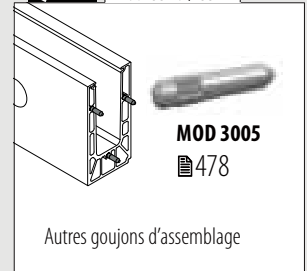

Q-INFO MOD 8312

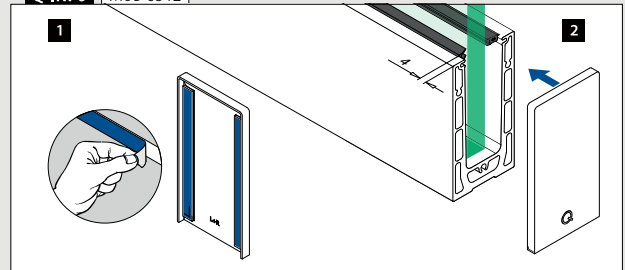

Profil de sol, montage latéral

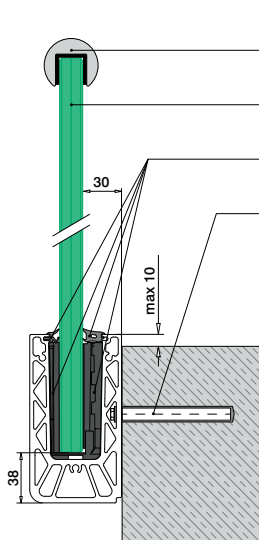

Optionnel :
 Tubes à fond de gorge : ■ 169 - 185
 Profilé de main courante Edge: ■ 166 - 168
 Verre de sécurité : ■ 160 - 161
 Q-disc® System: ■ 53
 Fixations : ■ 457 - 463

Merci de prendre en considération les spécifications de chaque certificat telles qu'épaisseur du verre, fixation et types de verre.

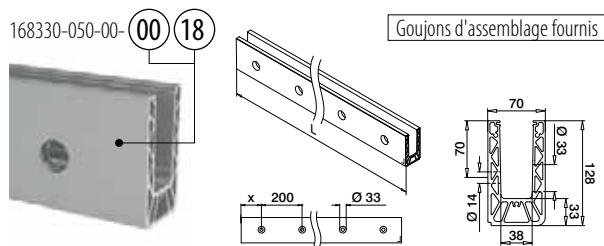

MOD 8330

Aluminium	Brut	X	■ 457 - 463	L = 5 m
168330-050-00	100			
Aluminium	Brossé, anodisé	OUTDOOR		
168330-025-00-18	50		■ 457 - 463	L = 2,5 m
168330-050-00-18	100		■ 457 - 463	L = 5 m



International Design
 Modèle Protection

Angles, montage latéral

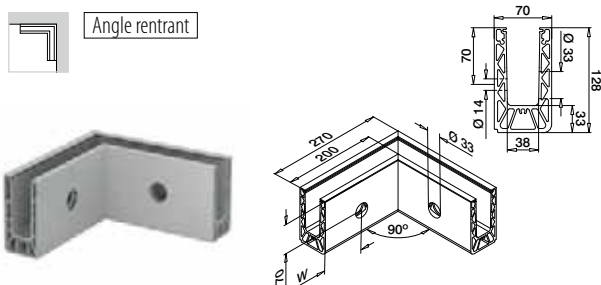

MOD 8331

Aluminium	Brut	W	■ 457 - 463	1
168331-01-00	100*			
Aluminium	Brossé, anodisé	OUTDOOR		
168331-01-18	100*		■ 457 - 463	1

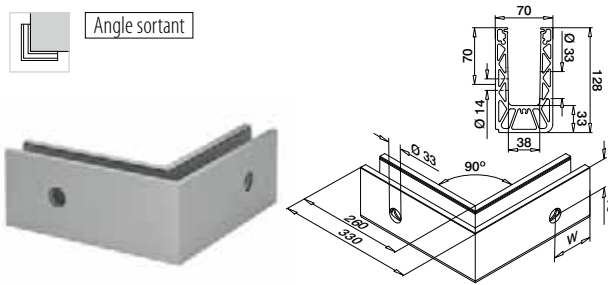

MOD 8331

Aluminium	Brut	W	■ 457 - 463	1
168331-02-00	100*			
Aluminium	Brossé, anodisé	OUTDOOR		
168331-02-18	100*		■ 457 - 463	1



*La position du trou peut varier en raison de la technique de production.

Q-INFO MOD 8330

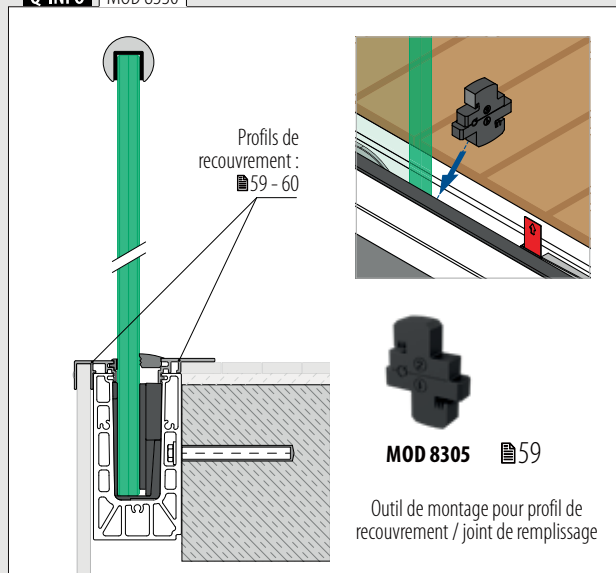

Profil de recouvrement : ■ 59 - 60

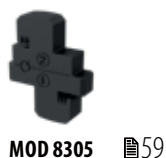

MOD 8305 ■ 59
 Outil de montage pour profil de recouvrement / joint de remplissage

Q-INFO MOD 8330

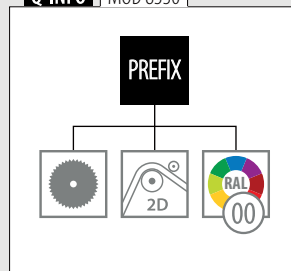

Q-INFO Aluminium



Q-INFO

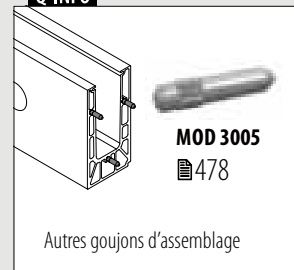

Autres goujons d'assemblage

Profil de garde-corps

Embouts, montage latéral

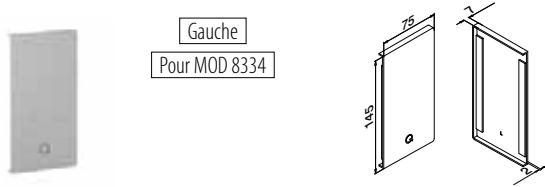

Gauche
Pour MOD 8334

MOD 8332

Aluminium	Brut	
Ruban adhésif		
168332-41-00	Fourni	1
Aluminium	Brossé, anodisé	
OUTDOOR		
168332-41-18	Pré-collé	1

NEW

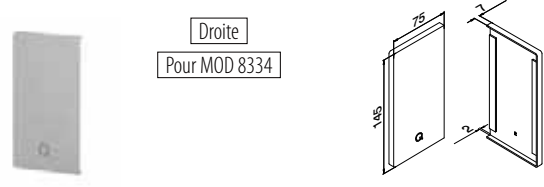

Droite
Pour MOD 8334

MOD 8332

Aluminium	Brut	
Ruban adhésif		
168332-42-00	Fourni	1
Aluminium	Brossé, anodisé	
OUTDOOR		
168332-42-18	Pré-collé	1

NEW

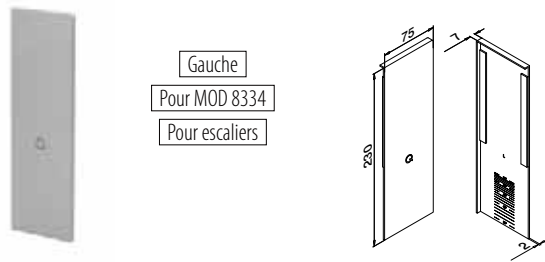

Gauche
Pour MOD 8334
Pour escaliers

MOD 8333

Aluminium	Brossé, anodisé	
OUTDOOR		
Ruban adhésif		
168333-41-18	Pré-collé	1

NEW

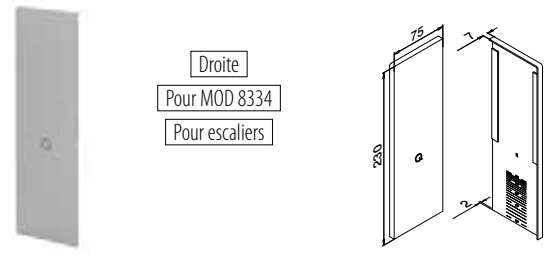

Droite
Pour MOD 8334
Pour escaliers

MOD 8333

Aluminium	Brossé, anodisé	
OUTDOOR		
Ruban adhésif		
168333-42-18	Pré-collé	1

NEW



Profil de garde-corps

Profils de drainage, montage latéral

4 pièces pour un profil de sol de 2,5 mètres
8 pièces pour un profilé de sol de 5 mètres

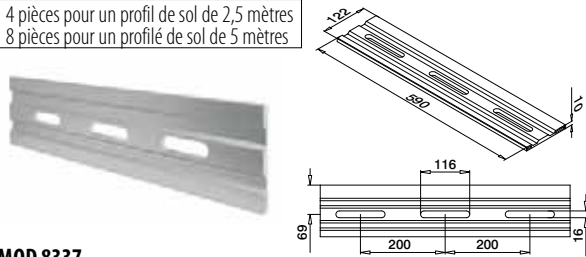

MOD 8337

Aluminium	Brossé, anodisé	
OUTDOOR		
Ruban adhésif		
168337-18		4

NEW

Profil de garde-corps

Cale, montage latéral

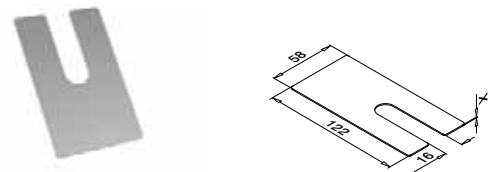

MOD 8336

Aluminium	Brut	
	X	
168336-001	1	100
168336-002	2	100
168336-003	3	100

NEW

Q-INFO MOD 8337

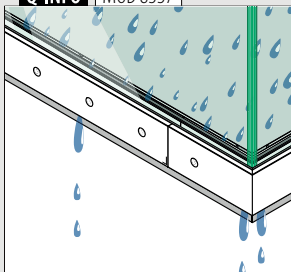

Informations sur l'assemblage :



<https://q-ne.ws/SmartPlus23>

Q-INFO MOD 8336

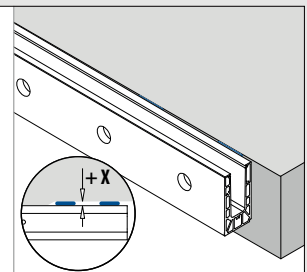
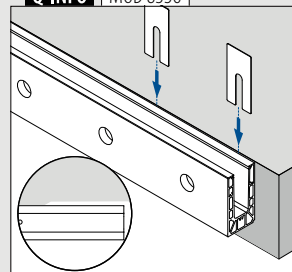

Habillage, montage latéral

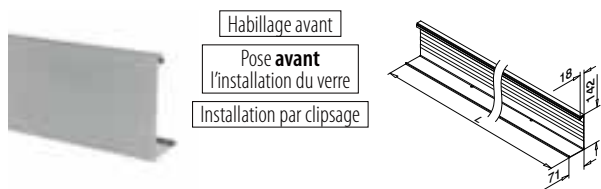

MOD 8334

Aluminium	Brut	
168334-050-00		L = 5 m
Aluminium	Brossé, anodisé	
OUTDOOR		
168334-050-18		L = 5 m

NEW

Embouts, montage latéral

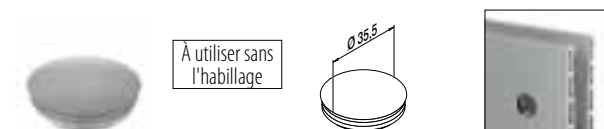

MOD 8238

Plastique	Aluminium blanc RAL 9006	
INDOOR		
158238-36		10

Butée de verre



MOD 8304

Accessoires	
208304	1

NEW

Q-INFO Aluminium

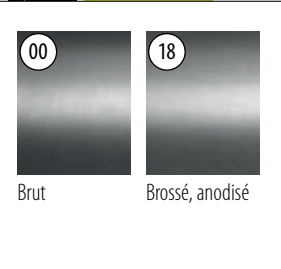

Q-INFO MOD 8334

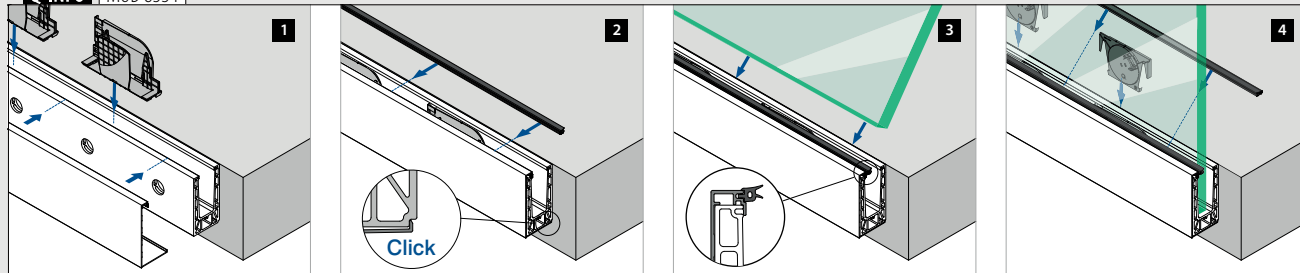

Q-INFO MOD 8238

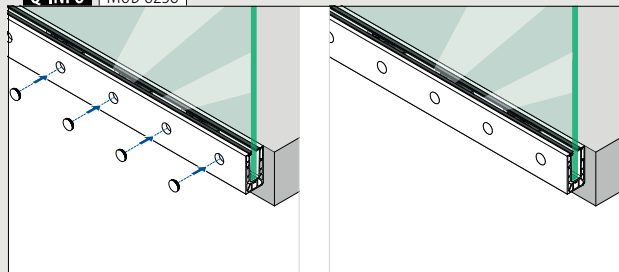

Q-INFO MOD 8304

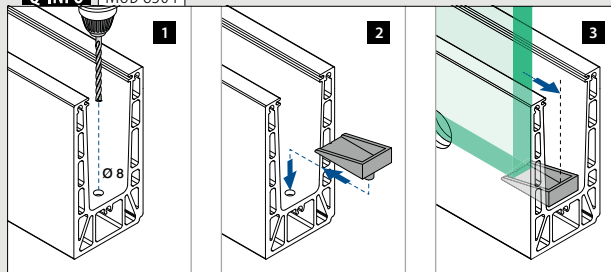

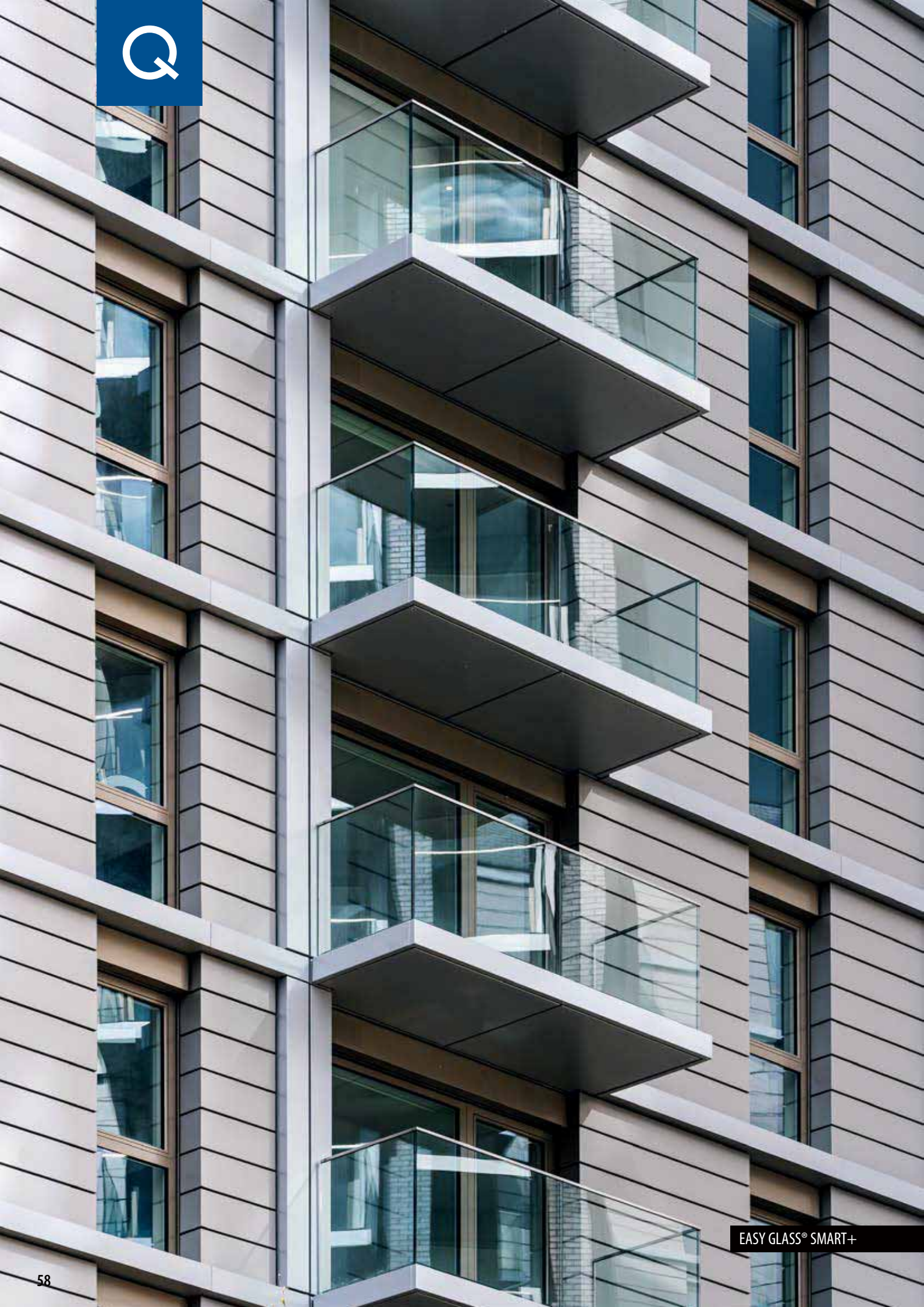

EASY GLASS® SMART+

Profils de recouvrement, montage au sol

Pour tous les profils Smart+

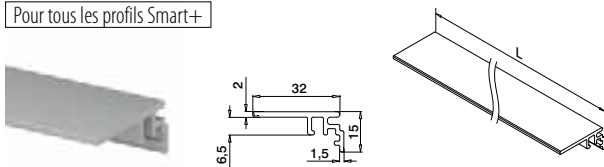

MOD 6973

Aluminium	Brut		
166973-50-00		L = 5 m	
Aluminium	Brossé, anodisé		
OUTDOOR			
166973-50-18		L = 5 m	

PREFIX

Pour les profils Smart+ au sol

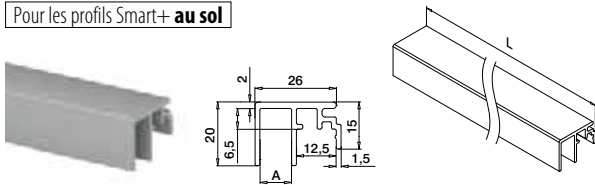

MOD 6972

Aluminium	Brut	A	
166972-010-50-00		10	L = 5 m
Aluminium	Brossé, anodisé		
OUTDOOR			
166972-010-50-18		10	L = 5 m

PREFIX

Pour tous les profils Smart+

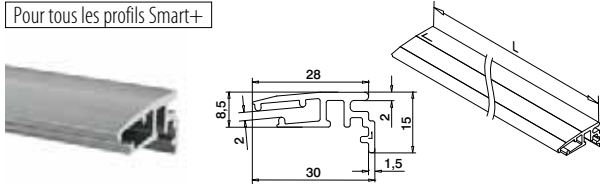

MOD 6979

Aluminium	Brut		
166979-002-50-00		L = 5 m	
Aluminium	Brossé, anodisé		
OUTDOOR			
166979-002-50-18		L = 5 m	

NEW

PREFIX

Pour les profils Smart+ au sol

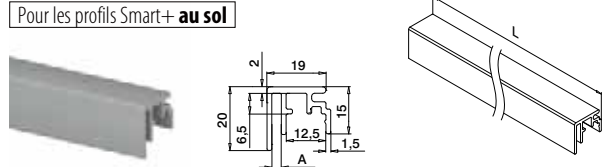

MOD 6972

Aluminium	Brut	A	
166972-003-50-00		3	L = 5 m
Aluminium	Brossé, anodisé		
OUTDOOR			
166972-003-50-18		3	L = 5 m

PREFIX

Pour les profils Smart+ au sol

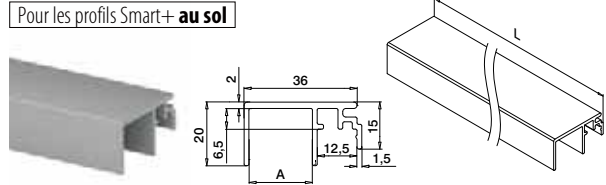

MOD 6972

Aluminium	Brut	A	
166972-020-50-00		20	L = 5 m
Aluminium	Brossé, anodisé		
OUTDOOR			
166972-020-50-18		20	L = 5 m

PREFIX

Profil de garde-corps

Outil de montage pour profil de recouvrement / joint de remplissage



MOD 8305

Accessoires			
208305-010		5	

NEW

PREFIX

Q-INFO MOD 6979

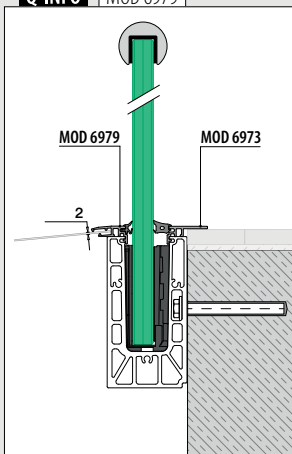

Q-INFO MOD 6972-010 / 6973

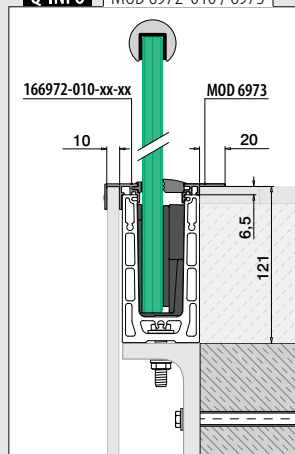

Q-INFO MOD 8305

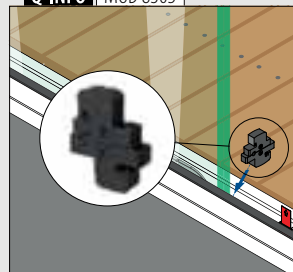

Profils de recouvrement, montage au sol

Pour tous les profils Smart+

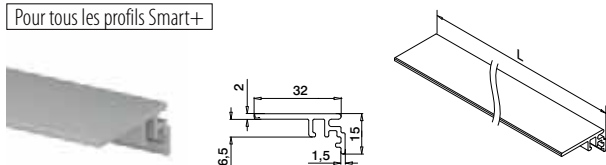

MOD 6973

Aluminium Brut

166973-50-00	L = 5 m
--------------	---------

Aluminium Brossé, anodisé

166973-50-18	L = 5 m
--------------	---------

PREFIX

Pour les profils Smart+ latéral

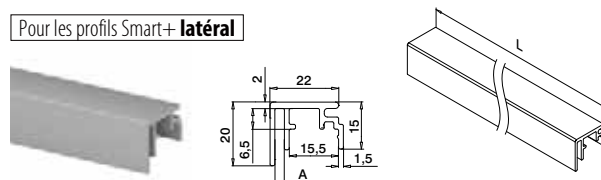

MOD 6970

Aluminium Brut

166970-003-50-00	3	L = 5 m
------------------	---	---------

Aluminium Brossé, anodisé

166970-003-50-18	3	L = 5 m
------------------	---	---------

PREFIX

Pour les profils Smart+ latéral

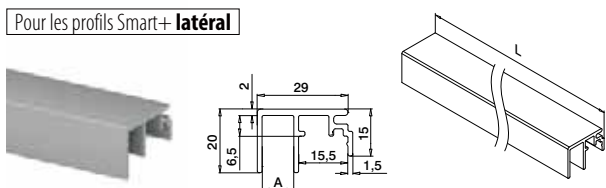

MOD 6970

Aluminium Brut

166970-010-50-00	10	L = 5 m
------------------	----	---------

Aluminium Brossé, anodisé

166970-010-50-18	10	L = 5 m
------------------	----	---------

PREFIX

Pour les profils Smart+ latéral

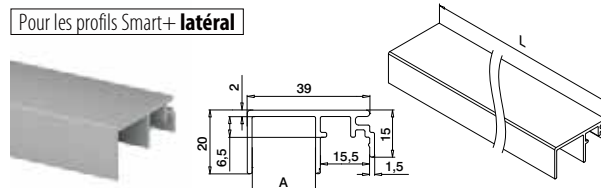

MOD 6970

Aluminium Brut

166970-020-50-00	20	L = 5 m
------------------	----	---------

Aluminium Brossé, anodisé

166970-020-50-18	20	L = 5 m
------------------	----	---------

PREFIX

Q-INFO

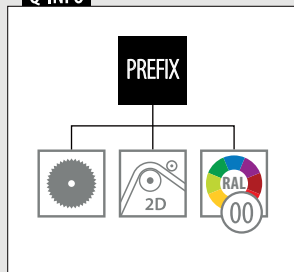

Q-INFO Aluminium



EASY GLASS® SMART+ **HIGH F + Y** PROFILS DE SOL

COMING SOON

EASY GLASS® SMART+ **HIGH Y**

Montage latéral

- Pour des niveaux de sol jusqu'à 180 mm.
- Aucune sous-structure nécessaire pour les niveaux de sol plus élevés.
- Hauteur ajustable : niveaux de sol entre 160 et 180 mm.
- Raccord sur toute la longueur du profil pour une vue dégagée.
- Compatible avec les profils et accessoires de notre gamme Easy Glass Smart+.
- Particulièrement adapté aux escaliers, aucune extension nécessaire (plaque d'acier ou autre).

EASY GLASS® SMART+ **HIGH F**

Montage au sol

- Pour des niveaux de sol jusqu'à 180 mm.
- Aucune sous-structure nécessaire pour les niveaux de sol plus élevés.
- Installation à l'intérieur ou à l'extérieur.
- Surface d'installation parfaite, possibilité d'installer des raccords standard ultérieurement.
- Compatible avec les profils et accessoires de notre gamme Easy Glass Smart+.



Conçu pour : Faible à résistante utilisation
Utilisation : Intérieur et extérieur
Variantes : Montage au sol, latéral et engravé
Applications : Balcons, galeries, passerelles, cloisons, escaliers, pare-vents et protection de fenêtres
Matériau : Aluminium (brossé anodisé, brut et thermolaqué en RAL 9005 noir)
Épaisseur de verre : 16,76 à 25,52 mm

Retrouvez toutes les informations sur Easy Glass Prime en ligne :

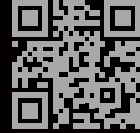

<https://q-ne.ws/Prime23>

EASY GLASS® PRIME



red dot winner 2020
innovative product

Boostez vos projets

Easy Glass® Prime est la solution qu'il vous faut lorsque vous cherchez un système de garde-corps pour du verre plus épais, permettant d'aligner facilement les panneaux. Les profils utilisant le Q-disc® System s'aligne et se fixe très facilement. Grâce aux tolérances des perçages, ce système est parfait pour les installations sur des surfaces inégales.



Easy Glass® Prime

Max. charge linéaire (kN/m)

BE

1,0

Tested at
WTCB.be
& CSTC.be

NBN
803-004

Merci de prendre en considération les spécifications de chaque certificat telles qu'épaisseur du verre, fixation.

Tests/calculs/certificats internationaux:

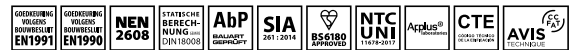

- 1 Ajustez chaque panneau jusqu'à 1,2° à la verticale.
- 2 Le Q-disc ajustable vous confirme la bonne installation grâce à un marquage clair et en émettant des « clics » sonores.
- 3 Convient pour des épaisseurs de verre comprises entre 16,76 et 25,52 mm.

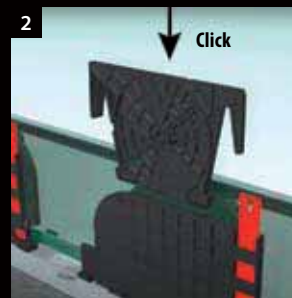

DÉCLINAISONS D'EASY GLASS® PRIME

Prime

Montage au sol

- Profil de sol symétrique

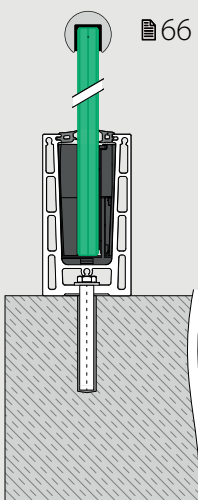

Prime F

Montage au sol

- Pour les sols bruts
- Peut aussi s'installer sur le bord d'une surface ou en débord

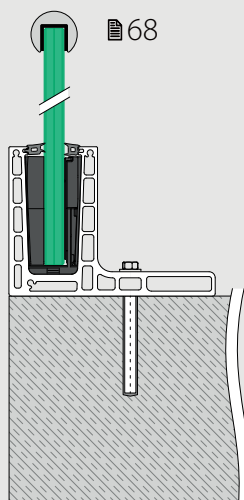

Prime

Montage latéral

- Également pour l'installation sur le côté intérieur des murs de parapet
- Habillages disponibles

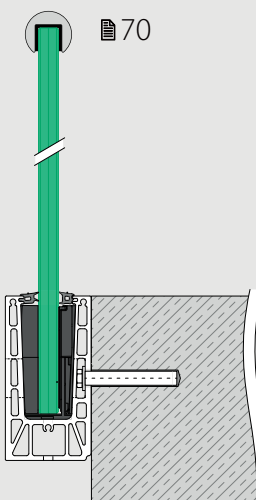

Prime Y

Montage latéral

- Pose latéral
- Peut aussi s'installer sur le bord d'une surface ou en débord
- Habillages disponibles

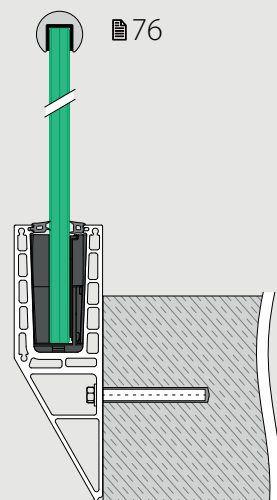



Q-DISC® SYSTEM AJUSTABLE FAITES COULISSER ET ALIGNEZ !



LE PRINCIPE:

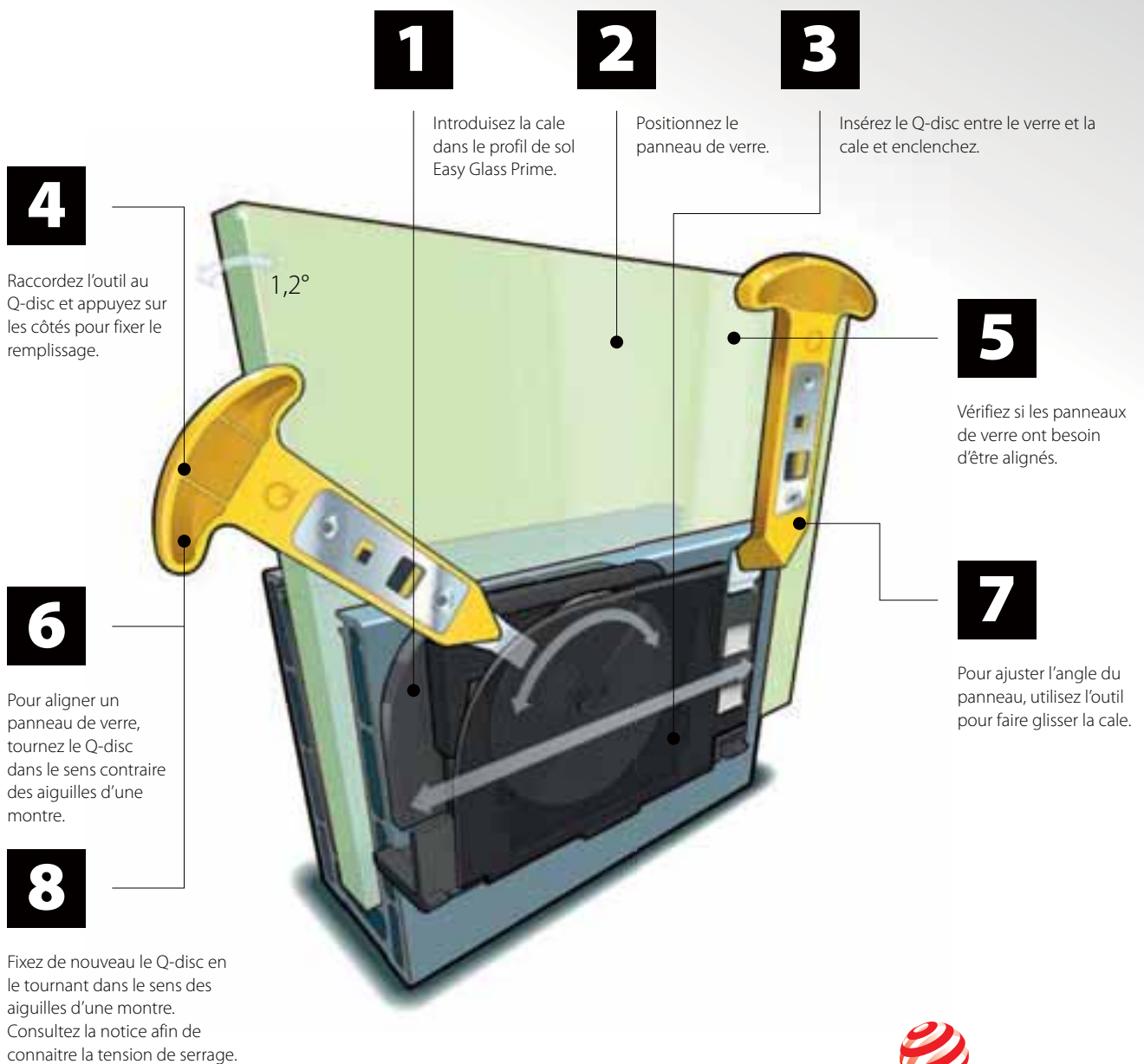

reddot winner 2020
innovative product

Q-disc® System (set de caoutchouc, cale et Q-disc®)

Pour une fixation ajustable du verre

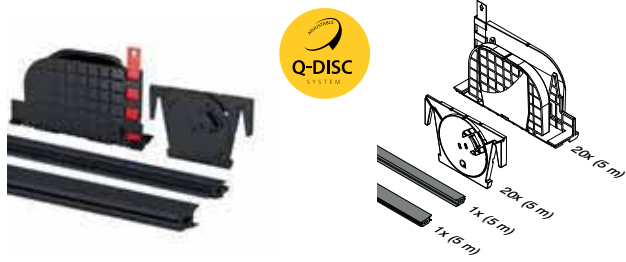

MOD 8401

Accessoires		
Pour verre monolithique	T	
208401-050-19	19	L = 5 m
Pour verre feuilleté		
208401-050-17	16,76	L = 5 m
208401-050-18	17,52	L = 5 m
208401-050-21	20,76	L = 5 m
208401-050-22	21,52	L = 5 m
208401-050-24	24,76	L = 5 m
208401-050-26	25,52	L = 5 m
208401-250-17	16,76	L = 25 m
208401-250-18	17,52	L = 25 m
208401-250-21	20,76	L = 25 m
208401-250-22	21,52	L = 25 m
208401-250-24	24,76	L = 25 m
208401-250-26	25,52	L = 25 m



International Design Modèle Protection

Accessoires

Outil pour Q-disc® et cale



MOD 1000

Accessoires		
	Q	
201000	Q-84	1

Joint de bourrage seuls

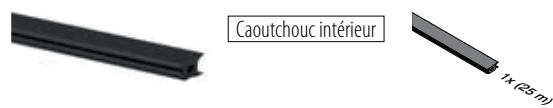

MOD 8407

Accessoires		
208407-250-00	L = 25 m	

NEW

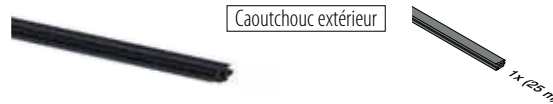

MOD 8407

Accessoires		
Pour verre monolithique	T	
208407-250-19	19	L = 25 m

Pour verre feuilleté

208407-250-17	16,76	L = 25 m
208407-250-18	17,52	L = 25 m
208407-250-21	20,76	L = 25 m
208407-250-22	21,52	L = 25 m
208407-250-24	24,76	L = 25 m
208407-250-26	25,52	L = 25 m

NEW

Accessoires

Sets de Q-disc®

Pour une fixation ajustable du verre



MOD 8409

Accessoires		
Pour verre monolithique	T	
208409-19	19	5

Pour verre feuilleté

208409-17	16,76	5
208409-18	17,52	5
208409-21	20,76	5
208409-22	21,52	5
208409-24	24,76	5
208409-26	25,52	5



Q-INFO MOD 1000

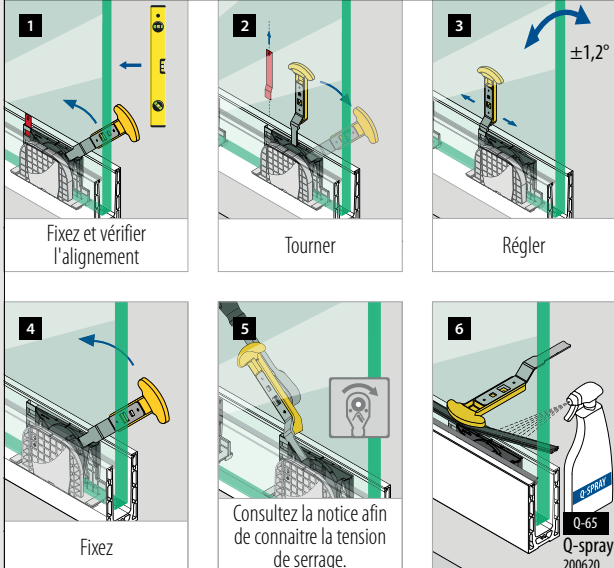

Q-INFO

Guide pour verre

MOD 1002

480



Profil de garde-corps

Profil de sol, montage au sol

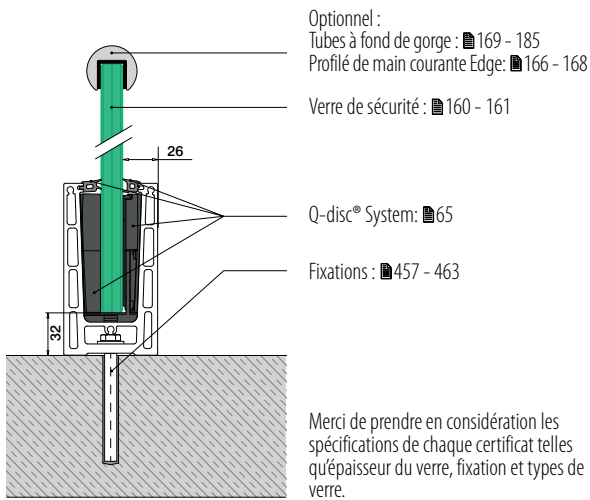

Profil de garde-corps

Angles, montage au sol

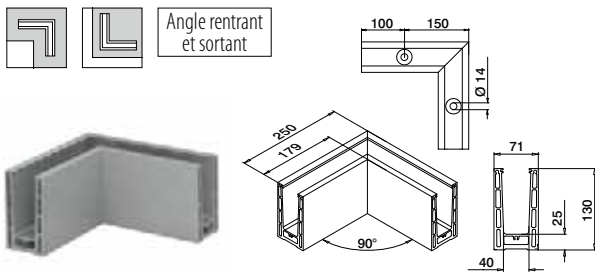

MOD 8411

Aluminium	Brut		
168411-00-00	█ 457 - 463		1
Aluminium	Brossé, anodisé		
168411-00-18	█ 457 - 463		1
Aluminium	Black Line		
168411-00-82	█ 457 - 463		1

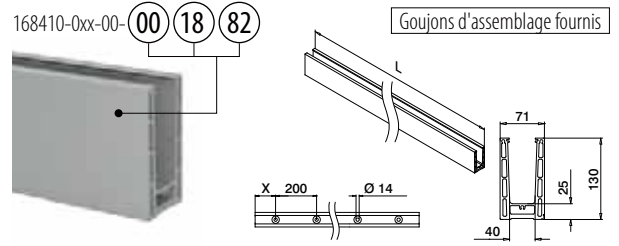

MOD 8410

Aluminium	Brut	X	
168410-050-00-00	100	█ 457 - 463	L = 5 m
Aluminium	Brossé, anodisé		
168410-025-00-18	50	█ 457 - 463	L = 2,5 m
168410-050-00-18	100	█ 457 - 463	L = 5 m
Aluminium	Black Line		
168410-050-00-82	100	█ 457 - 463	L = 5 m



International Design
Modèle Protection

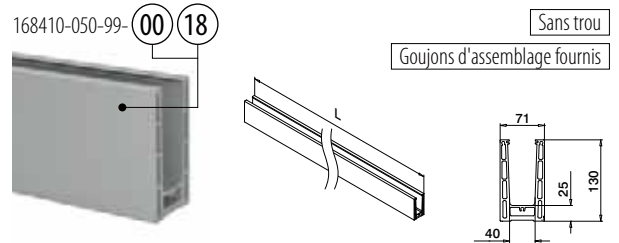

MOD 8410

Aluminium	Brut		
168410-050-99-00			L = 5 m
Aluminium	Brossé, anodisé		
168410-050-99-18			L = 5 m



International Design
Modèle Protection

Q-INFO MOD 8410

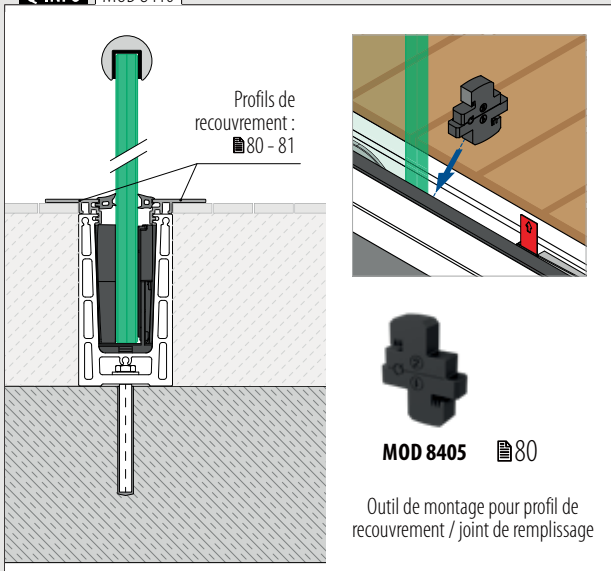

Q-INFO MOD 8410

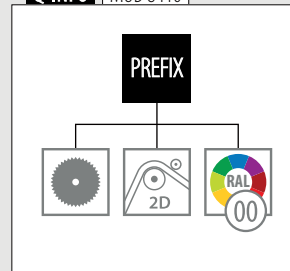

Q-INFO

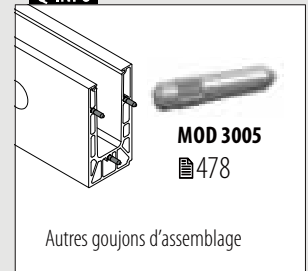

Q-INFO Aluminium

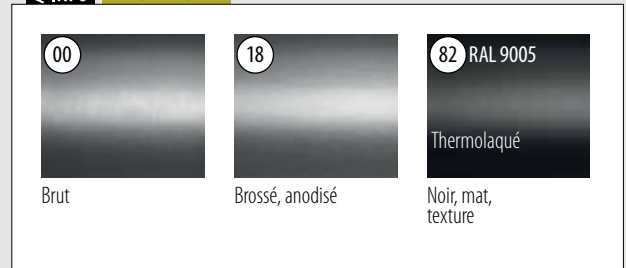

Profil de garde-corps

Embout, montage au sol

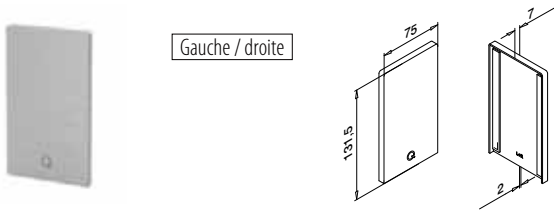

MOD 8412

Aluminium	Brut		
		Ruban adhésif	
168412-00-00	Fourni		1
Aluminium	Brossé, anodisé		
		OUTDOOR	
168412-00-18	Pré-collé		1
Aluminium	Black Line		
		OUTDOOR	
NEW	168412-00-82	Pré-collé	1

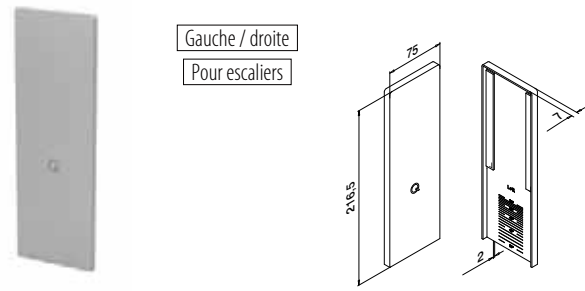

MOD 8413

Aluminium	Brut		
		Ruban adhésif	
168413-00-00	Fourni		1
Aluminium	Brossé, anodisé		
		OUTDOOR	
168413-00-18	Pré-collé		1



Profil de garde-corps

Cale, montage au sol

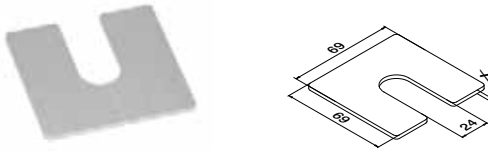

MOD 8416

Aluminium	Brut		
		X	
168416-001	1		100
168416-002	2		100
168416-003	3		100

Profil de garde-corps

Profils de drainage, montage au sol

4 pièces pour un profil de sol de 2,5 mètres
8 pièces pour un profilé de sol de 5 mètres

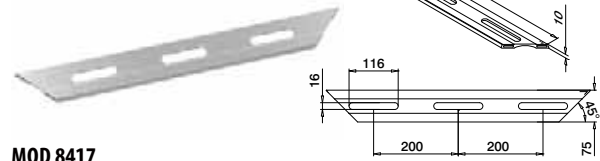

MOD 8417

Aluminium	Brossé, anodisé		
		OUTDOOR	
168417-18			4

Q-INFO MOD 8412

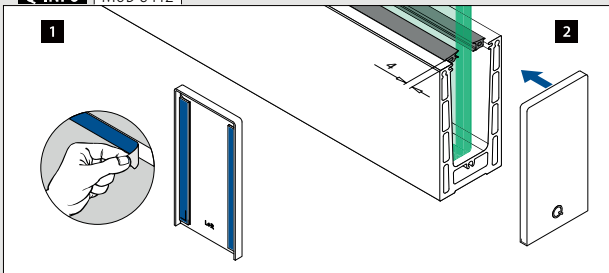

Q-INFO MOD 8416

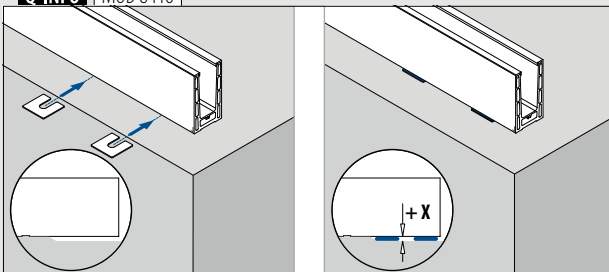

Q-INFO MOD 8413

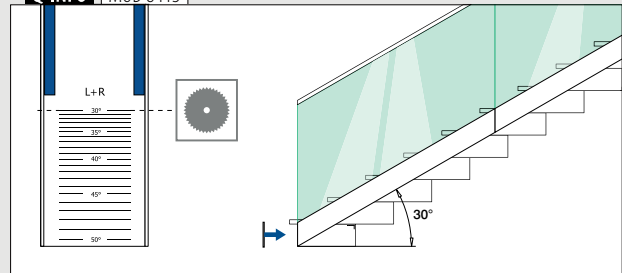

Q-INFO MOD 8417

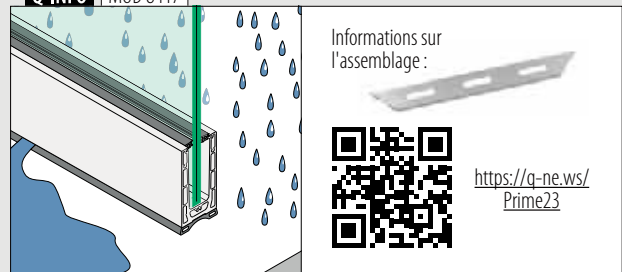

Profil de garde-corps

Profil de sol, montage au sol

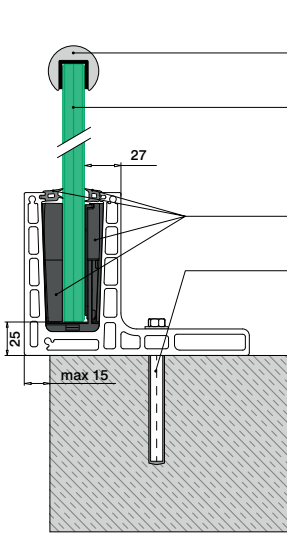

- Optionnel :
Tubes à fond de gorge : █ 169 - 185
Profilé de main courante Edge: █ 166 - 168
- Verre de sécurité : █ 160 - 161
- Q-disc® System: █ 65
- Fixations : █ 457 - 463

Merci de prendre en considération les spécifications de chaque certificat telles qu'épaisseur du verre, fixation et types de verre.

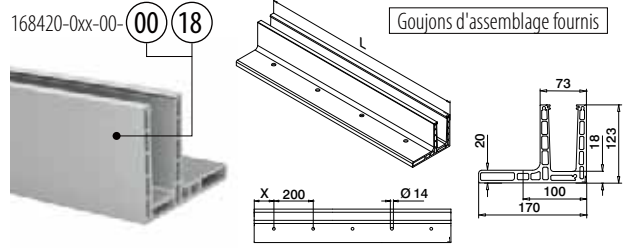

MOD 8420

Aluminium	Brut	X	█ 457 - 463	L = 5 m
168420-050-00-00		100		
Aluminium	Brossé, anodisé	OUTDOOR		
168420-025-00-18		50	█ 457 - 463	L = 2,5 m
168420-050-00-18		100	█ 457 - 463	L = 5 m



International Design
Modèle Protection

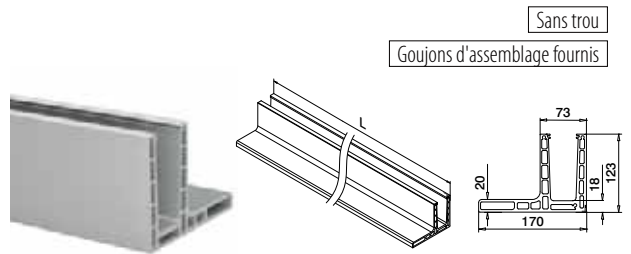

MOD 8420

Aluminium	Brossé, anodisé	OUTDOOR	█ 457 - 463	L = 5 m
168420-050-99-18				



International Design
Modèle Protection

Q-INFO

Profil de recouvrement : █ 80 - 81

MOD 8405 █ 80

Outil de montage pour profil de recouvrement / joint de remplissage

Q-INFO

Q-INFO Aluminium

00	18
Brut	Brossé, anodisé

Q-INFO

MOD 3005
█ 478

Autres goujons d'assemblage

Angles, montage au sol

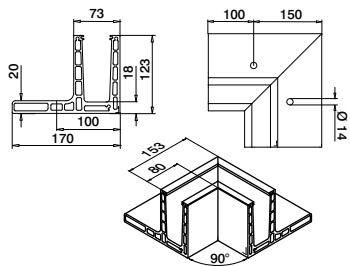

MOD 8421

Aluminium	Brossé, anodisé		
OUTDOOR			
168421-01-18	457 - 463		1

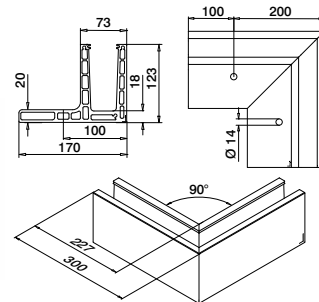

MOD 8421

Aluminium	Brossé, anodisé		
OUTDOOR			
168421-02-18	457 - 463		1



Embouts, montage au sol

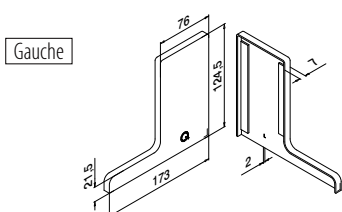

MOD 8422

Aluminium	Brut		
	Ruban adhésif		
168422-01-00	Fourni		1
Aluminium	Brossé, anodisé		
OUTDOOR			
168422-01-18	Pré-collé		1

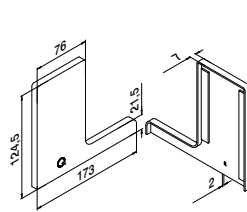

MOD 8422

Aluminium	Brut		
	Ruban adhésif		
168422-02-00	Fourni		1
Aluminium	Brossé, anodisé		
OUTDOOR			
168422-02-18	Pré-collé		1

Q-INFO MOD 8422

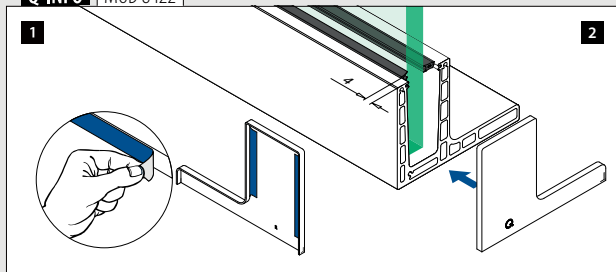

Profil de garde-corps

Profil de sol, montage latéral

Optionnel :
Tubes à fond de gorge : █ 169 - 185
Profilé de main courante Edge: █ 166 - 168

Verre de sécurité : █ 160 - 161

Q-disc® System: █ 65

Fixations : █ 457 - 463

Merci de prendre en considération les spécifications de chaque certificat telles qu'épaisseur du verre, fixation et types de verre.

168430-0xx-00-00 18

Goujons d'assemblage fournis

MOD 8430

Aluminium	Brut	X	█ 457 - 463	L = 5 m
168430-050-00-00	100			
Aluminium	Brossé, anodisé	OUTDOOR		
168430-025-00-18	50		█ 457 - 463	L = 2,5 m
168430-050-00-18	100		█ 457 - 463	L = 5 m



International Design
Modèle Protection

Profil de garde-corps

Angles, montage latéral

Angle rentrant

MOD 8431

Aluminium	Brut	W	█ 457 - 463	1
168431-01-00	100*			
Aluminium	Brossé, anodisé	OUTDOOR		
168431-01-18	100*		█ 457 - 463	1



Angle sortant

MOD 8431

Aluminium	Brut	W	█ 457 - 463	1
168431-02-00	100*			
Aluminium	Brossé, anodisé	OUTDOOR		
168431-02-18	100*		█ 457 - 463	1



*La position du trou peut varier en raison de la technique de production.

Q-INFO MOD 8430

Profil de recouvrement : █ 80 - 81

MOD 8405 █ 80

Outil de montage pour profil de recouvrement / joint de remplissage

Q-INFO MOD 8430

PREFIX

Q-INFO Aluminium

00 Brut

18 Brossé, anodisé

Q-INFO

MOD 3005 █ 478

Autres goujons d'assemblage

Embouts, montage latéral

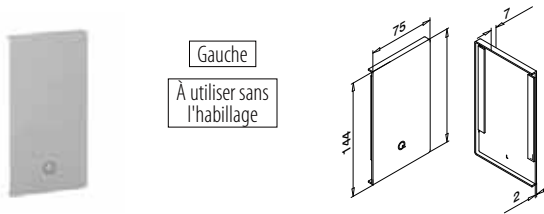

MOD 8432

Aluminium	Brut		
Ruban adhésif			
168432-01-00	Fourni		1
Aluminium	Brossé, anodisé		
OUTDOOR			
168432-01-18	Pré-collé		1

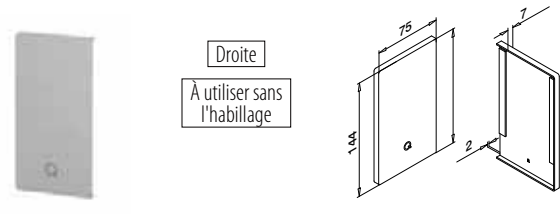

MOD 8432

Aluminium	Brut		
Ruban adhésif			
168432-02-00	Fourni		1
Aluminium	Brossé, anodisé		
OUTDOOR			
168432-02-18	Pré-collé		1

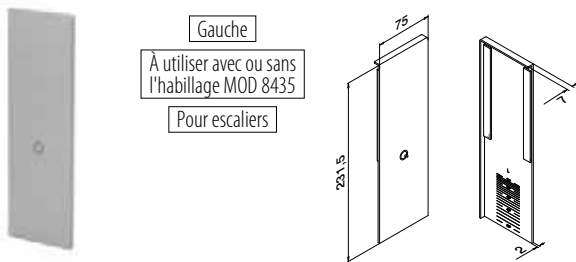

MOD 8433

Aluminium	Brut		
Ruban adhésif			
168433-01-00	Fourni		1
Aluminium	Brossé, anodisé		
OUTDOOR			
168433-01-18	Pré-collé		1

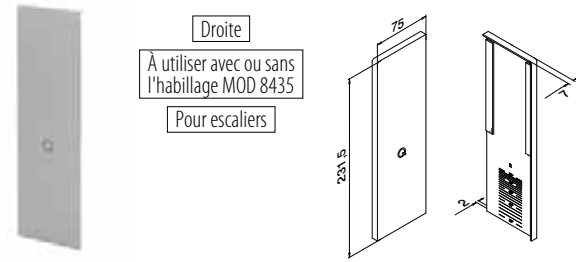

MOD 8433

Aluminium	Brut		
Ruban adhésif			
168433-02-00	Fourni		1
Aluminium	Brossé, anodisé		
OUTDOOR			
168433-02-18	Pré-collé		1



Q-INFO | MOD 8432 / 8433

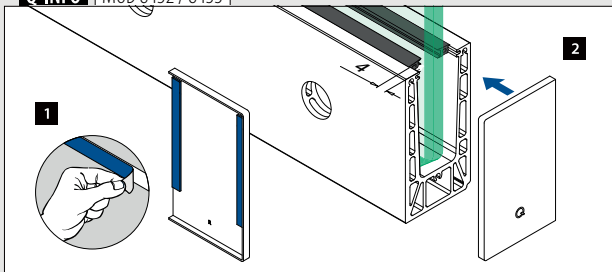

Q-INFO | MOD 8433

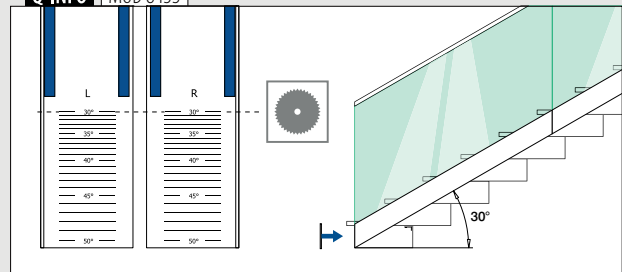

Embouts, montage latéral

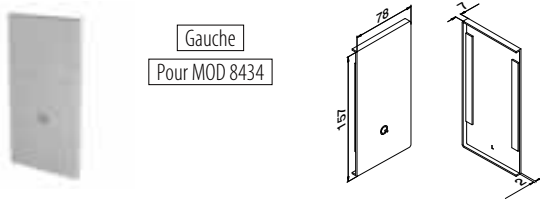

MOD 8432

Aluminium	Brut		
	Ruban adhésif		
168432-41-00	Fourni	1	
Aluminium	Brossé, anodisé		
OUTDOOR			
168432-41-18	Pré-collé	1	

NEW

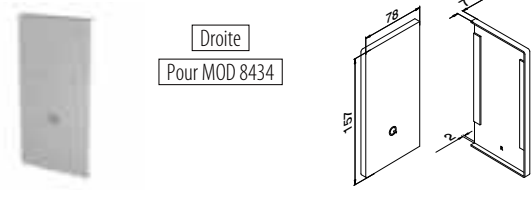

MOD 8432

Aluminium	Brut		
	Ruban adhésif		
168432-42-00	Fourni	1	
Aluminium	Brossé, anodisé		
OUTDOOR			
168432-42-18	Pré-collé	1	

NEW

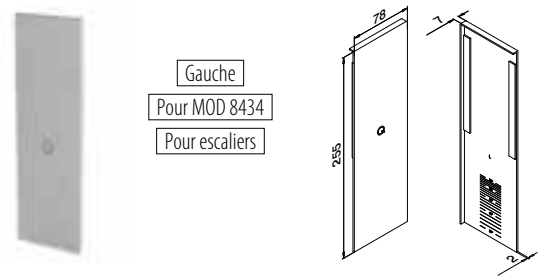

MOD 8433

Aluminium	Brossé, anodisé		
OUTDOOR	Ruban adhésif		
168433-41-18	Pré-collé	1	

NEW

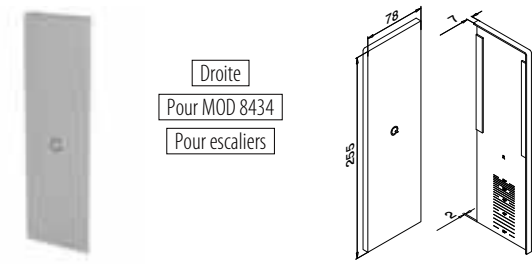

MOD 8433

Aluminium	Brossé, anodisé		
OUTDOOR	Ruban adhésif		
168433-42-18	Pré-collé	1	

NEW



Q-INFO Aluminium

00

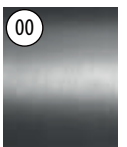

Brut

18

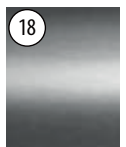

Brossé, anodisé

Profils de drainage, montage latéral

4 pièces pour un profil de sol de 2,5 mètres
8 pièces pour un profilé de sol de 5 mètres

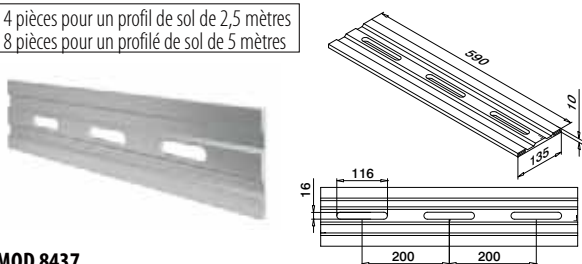

MOD 8437

Aluminium	Brossé, anodisé	
OUTDOOR		
168437-18		4

Embouts, montage latéral

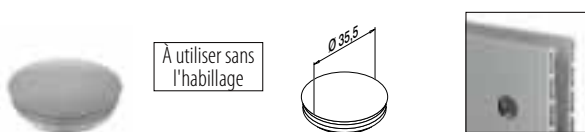

MOD 8238

Plastique	Aluminium blanc RAL 9006	
INDOOR		
158238-36		10

Cale, montage latéral

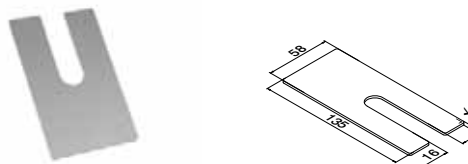

MOD 8436

Aluminium	Brut	
	X	
168436-001	1	100
168436-002	2	100
168436-003	3	100

Butée de verre



MOD 8404

Accessoires		
208404		1

NEW

Q-INFO MOD 8437

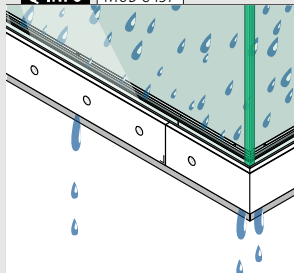

Informations sur l'assemblage :



<https://q-ne.ws/Prime23>



Q-INFO MOD 8436

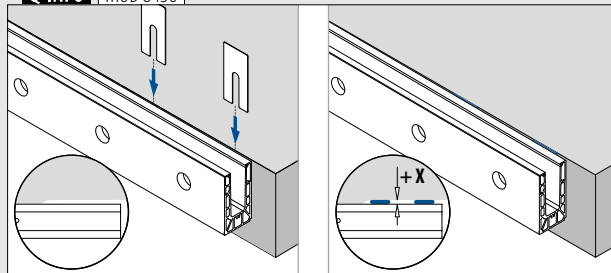

Q-INFO MOD 8238

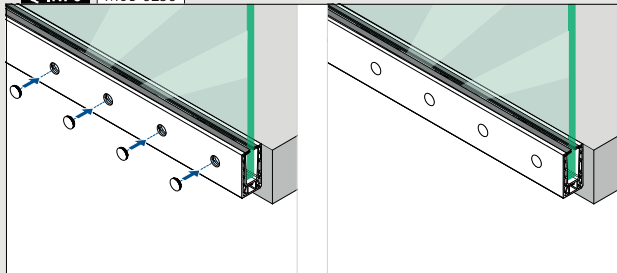

Q-INFO MOD 8404

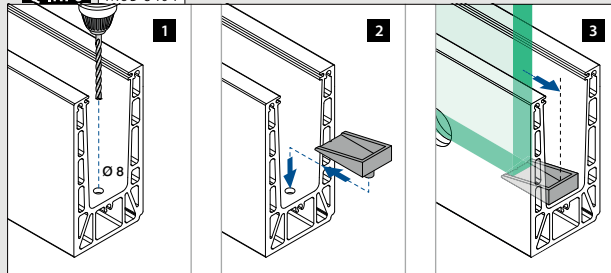

Profil de garde—corps

Habillage, montage latéral

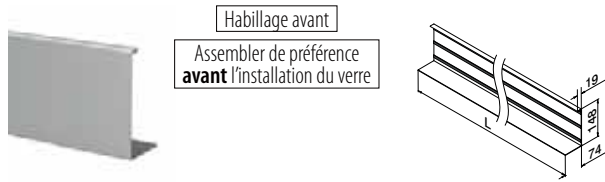

MOD 8435

Aluminium	Brut		
Ruban adhésif			
SELL OUT 168435-050-00	Non compris*	L = 5 m	
Aluminium	Brossé, anodisé		
OUTDOOR			
SELL OUT 168435-050-18	Pré-collé	L = 5 m	



*Commander MOD 1360 (ruban adhésif)

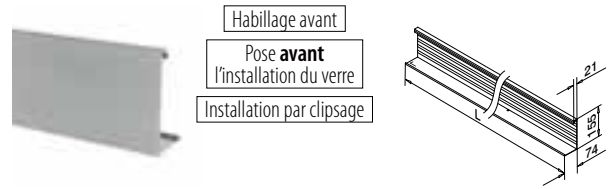

MOD 8434

Aluminium	Brut		
Ruban adhésif			
168434-050-00		L = 5 m	
Aluminium	Brossé, anodisé		
OUTDOOR			
168434-050-18		L = 5 m	



Accessoires

Ruban adhésif acrylique



MOD 1360

Accessoires				
	Q	W	L	
201360	Q-53	9	33 m (pour 11 m d'habillage)	1

Q-INFO MOD 8435-050-00 / 1360

Informations sur l'assemblage :

00



<https://q-news/Prime23>

Q-INFO Aluminium

00



Brut

18



Brossé, anodisé



Seulement jusqu'à épuisement des stocks.

Q-INFO MOD 8435

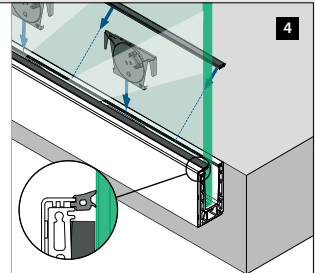
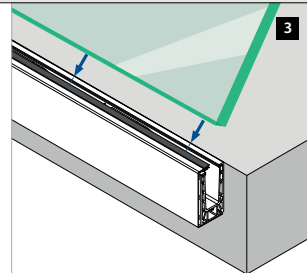
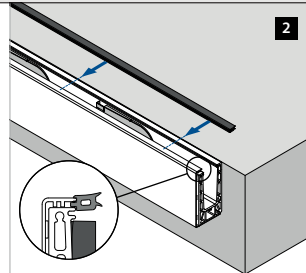
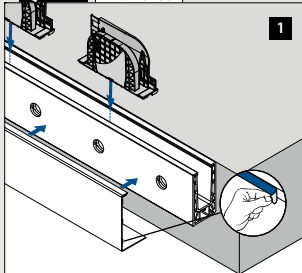

Q-INFO MOD 8434

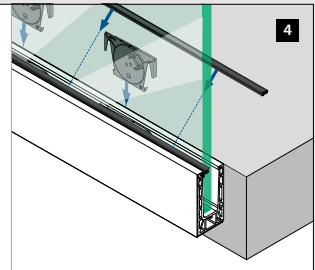
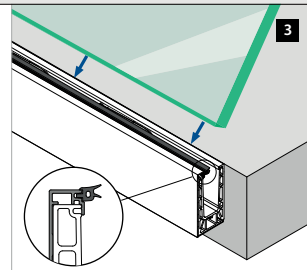
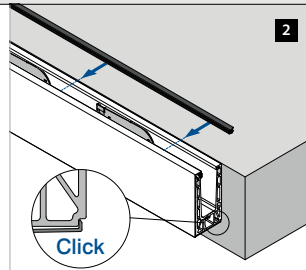
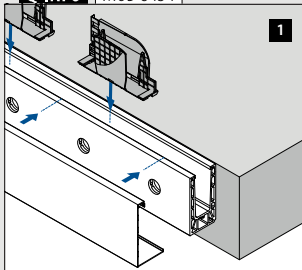

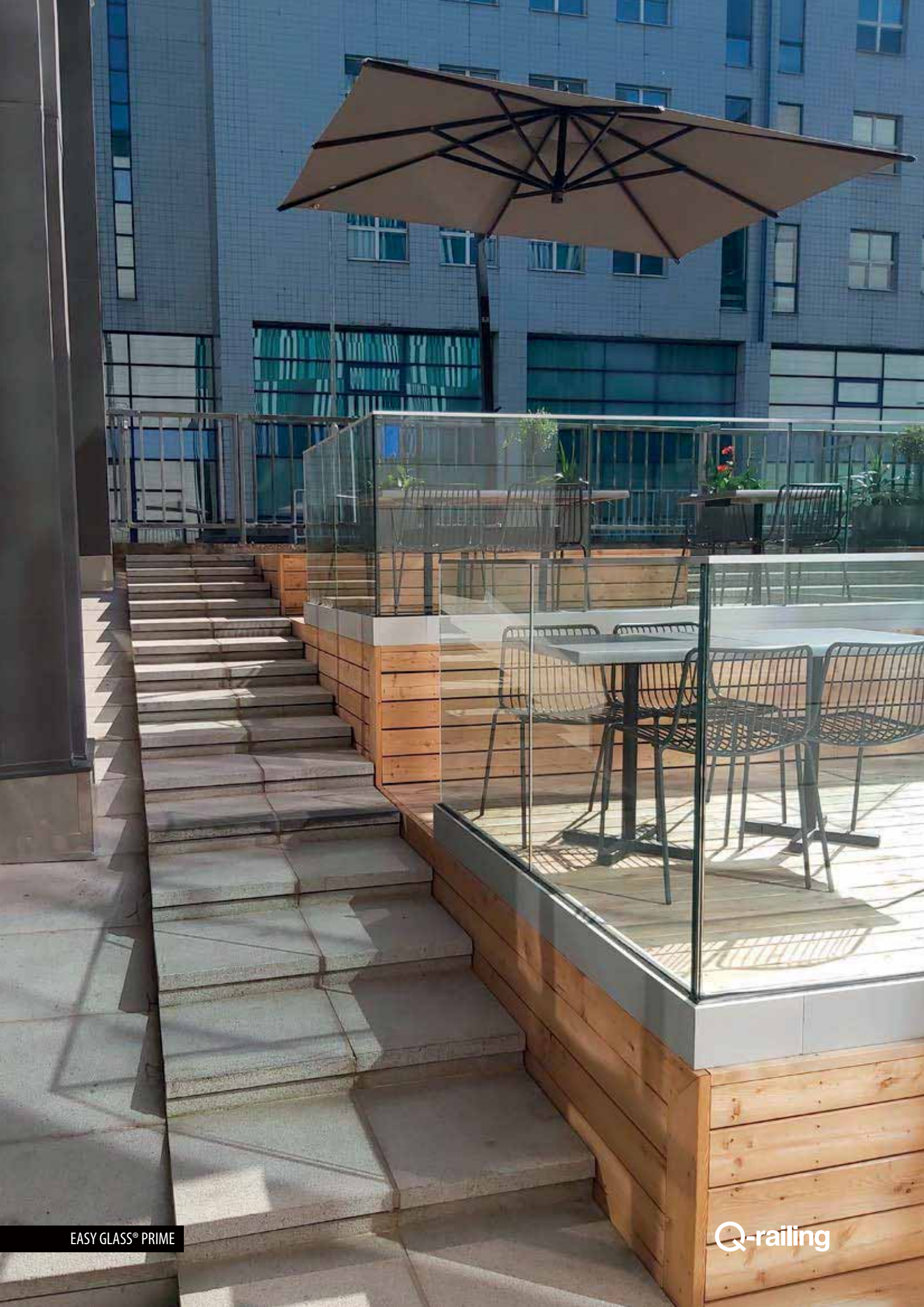

Profil de garde-corps

Profil de sol, montage latéral

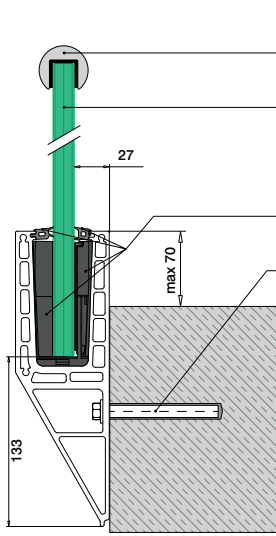

Optionnel :
Tubes à fond de gorge : 169 - 185
Profilé de main courante Edge: 166 - 168
Verre de sécurité : 160 - 161

Q-disc® System: 65
Fixations : 457 - 463

Merci de prendre en considération les spécifications de chaque certificat telles qu'épaisseur du verre, fixation et types de verre.

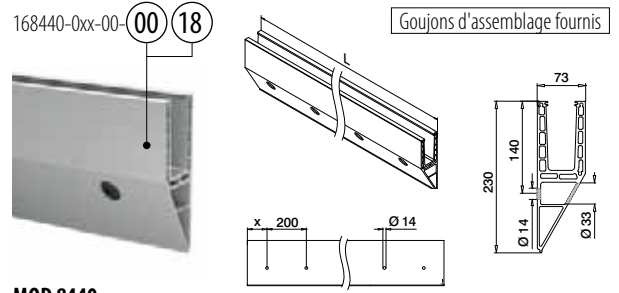

MOD 8440

Aluminium	Brut			
	X			
168440-050-00-00	100	457 - 463	L = 5 m	
Aluminium	Brossé, anodisé			
OUTDOOR				
168440-025-00-18	50	457 - 463	L = 2,5 m	
168440-050-00-18	100	457 - 463	L = 5 m	



International Design
Modèle Protection

Sans trou

Goujons d'assemblage fournis

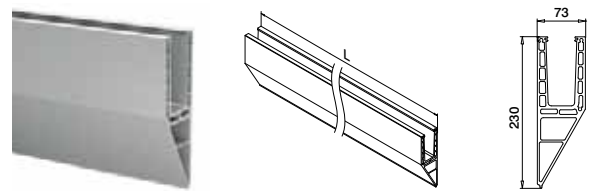

MOD 8440

Aluminium	Brossé, anodisé			
OUTDOOR				
168440-050-99-18			L = 5 m	



International Design
Modèle Protection

Q-INFO

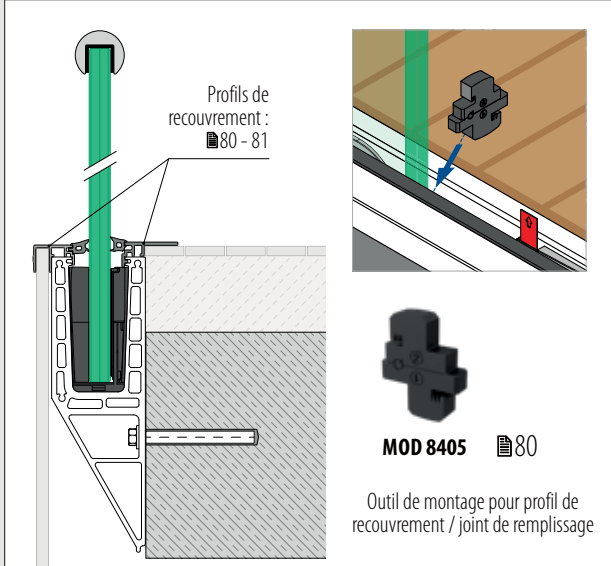

Profil de recouvrement : 80 - 81

MOD 8405 80

Outil de montage pour profil de recouvrement / joint de remplissage

Q-INFO

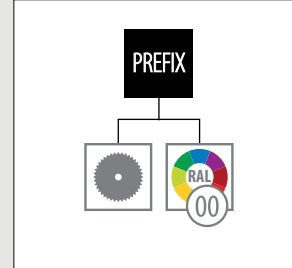

Q-INFO Aluminium

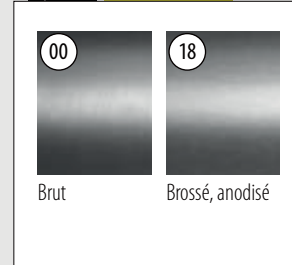

Q-INFO

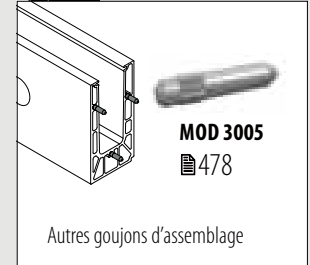

MOD 3005
478

Autres goujons d'assemblage

Angles, montage latéral

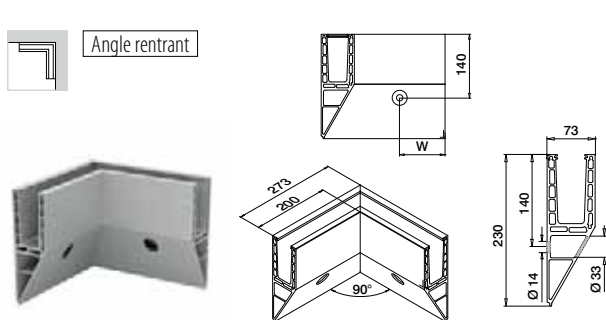

MOD 8441

Aluminium	Brossé, anodisé		
OUTDOOR	W		
168441-01-18	100*	457 - 463	1

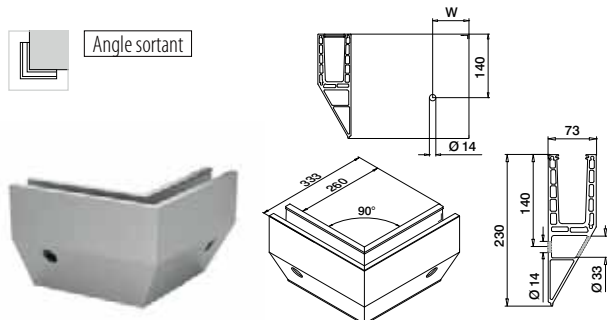

MOD 8441

Aluminium	Brossé, anodisé		
OUTDOOR	W		
168441-02-18	100*	457 - 463	1



*La position du trou peut varier en raison de la technique de production.

Embouts, montage latéral

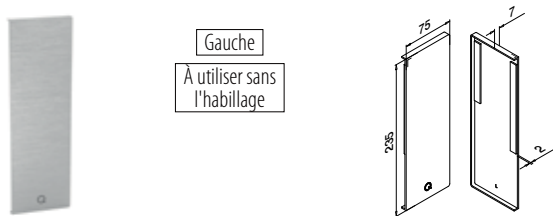

MOD 8442

Aluminium	Brut		
	Ruban adhésif		
168442-01-00	Fourni		1
Aluminium	Brossé, anodisé		
OUTDOOR			
168442-01-18	Pré-collé		1

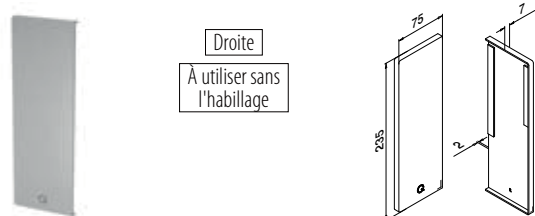

MOD 8442

Aluminium	Brut		
	Ruban adhésif		
168442-02-00	Fourni		1
Aluminium	Brossé, anodisé		
OUTDOOR			
168442-02-18	Pré-collé		1

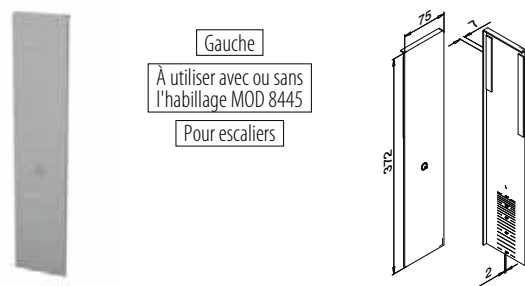

MOD 8443

Aluminium	Brossé, anodisé		
OUTDOOR	Ruban adhésif		
168443-01-18	Pré-collé		1

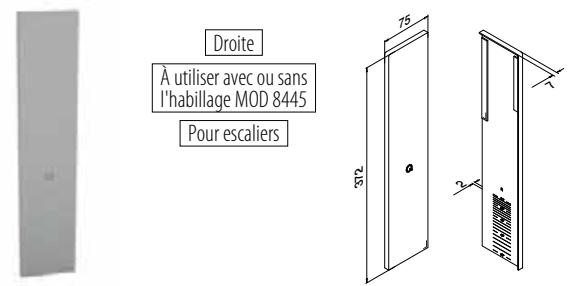

MOD 8443

Aluminium	Brossé, anodisé		
OUTDOOR	Ruban adhésif		
168443-02-18	Pré-collé		1



Q-INFO MOD 8442 / 8443

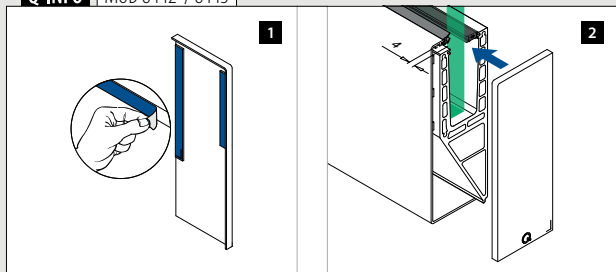

Q-INFO MOD 8443

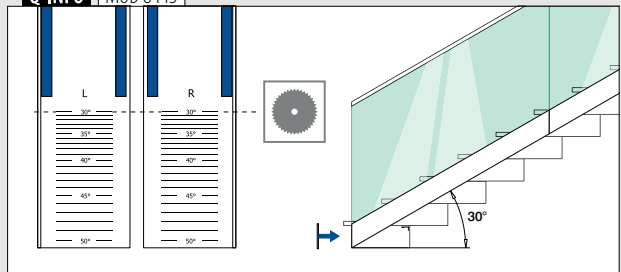

Profil de garde-corps

Embouts, montage latéral

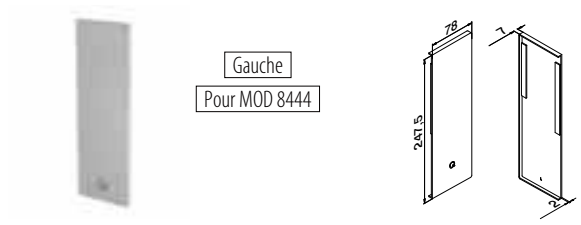

Gauche
Pour MOD 8444



Droite
Pour MOD 8444

MOD 8442

Aluminium	Brut		
	Ruban adhésif		
168442-41-00	Fourni	1	
Aluminium	Brossé, anodisé		
OUTDOOR			
168442-41-18	Pré-collé	1	

NEW

MOD 8442

Aluminium	Brut		
	Ruban adhésif		
168442-42-00	Fourni	1	
Aluminium	Brossé, anodisé		
OUTDOOR			
168442-42-18	Pré-collé	1	

NEW

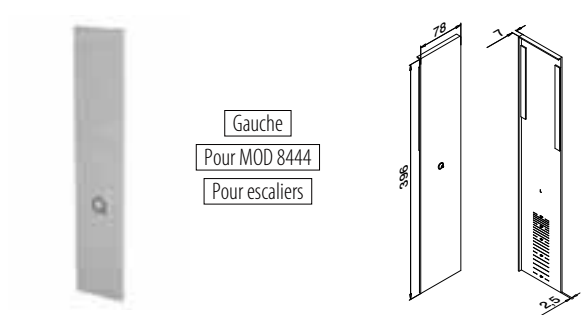

Gauche
Pour MOD 8444
Pour escaliers

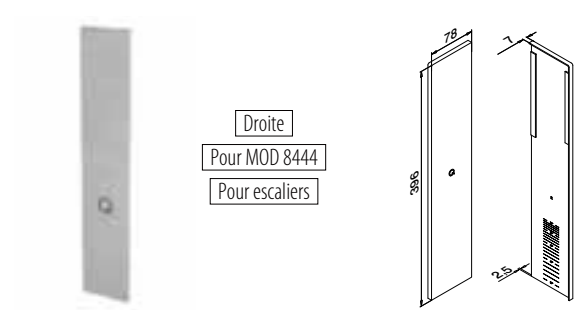

Droite
Pour MOD 8444
Pour escaliers

MOD 8443

Aluminium	Brossé, anodisé		
OUTDOOR	Ruban adhésif		
168443-41-18	Pré-collé	1	

NEW



MOD 8443

Aluminium	Brossé, anodisé		
OUTDOOR	Ruban adhésif		
168443-42-18	Pré-collé	1	

NEW



Profil de garde-corps

Butée de verre



MOD 8404

Accessoires			
208404		1	

NEW

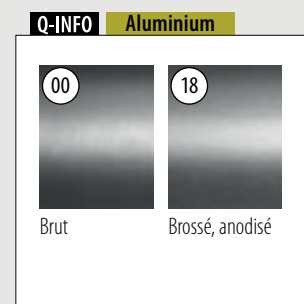
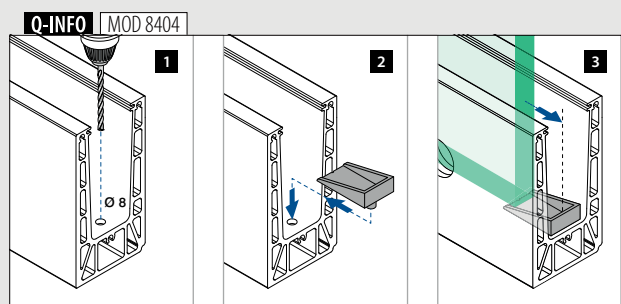

Habillage, montage latéral

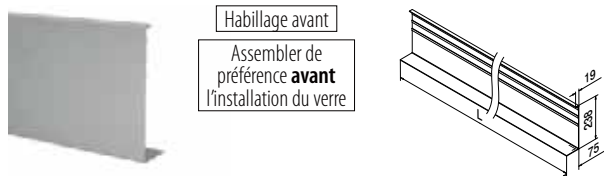

MOD 8445

Aluminium	Brut		
Ruban adhésif			
SELL OUT 168445-050-00	Non compris*	L = 5 m	
Aluminium	Brossé, anodisé		
OUTDOOR			
SELL OUT 168445-050-18	Pré-collé	L = 5 m	



*Commander MOD 1360 (ruban adhésif)

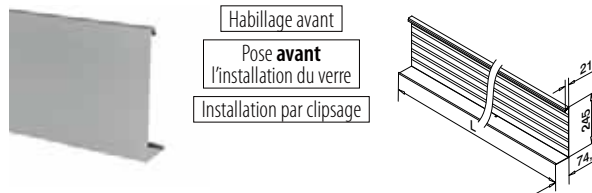

MOD 8444

Aluminium	Brut		
Ruban adhésif			
168444-050-00		L = 5 m	
Aluminium	Brossé, anodisé		
OUTDOOR			
168444-050-18		L = 5 m	



Accessoires

Ruban adhésif acrylique



MOD 1360

Accessoires				
	Q	W	L	
201360	Q-53	9	33 m (pour 11 m d'habillage)	1

Q-INFO MOD 8445-050-00 / 1360

Informations sur l'assemblage :

00



<https://q-ne.ws/Prime23>



Seulement jusqu'à épuisement des stocks.

Q-INFO MOD 8445

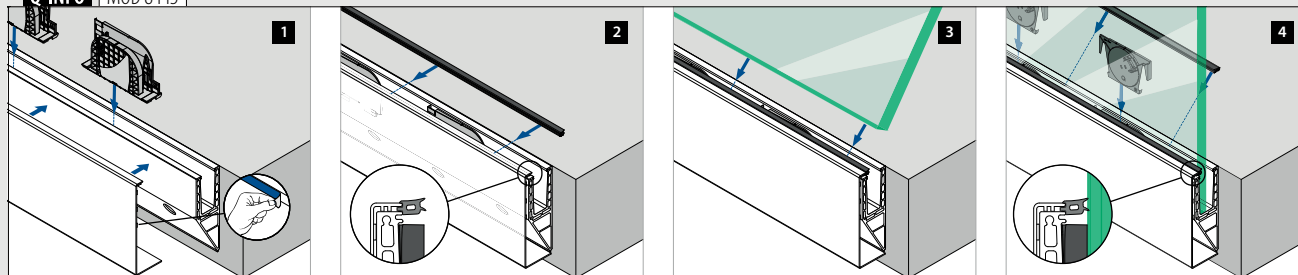

Q-INFO MOD 8444

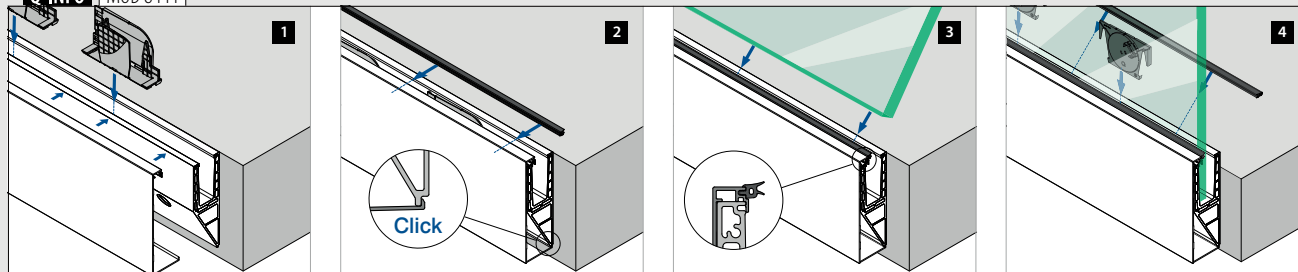

Profil de garde-corps

Profils de recouvrement, montage au sol

Pour tous les profils Prime

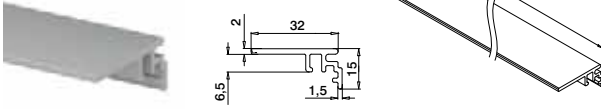

MOD 6973

Aluminium	Brut	
166973-50-00		L = 5 m
Aluminium	Brossé, anodisé	
OUTDOOR		
166973-50-18		L = 5 m

PREFIX

Pour les profils Prime **au sol**

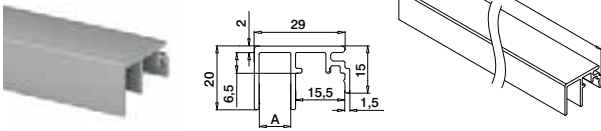

MOD 6970

Aluminium	Brut	
	A	
166970-010-50-00	10	L = 5 m
Aluminium	Brossé, anodisé	
OUTDOOR		
166970-010-50-18	10	L = 5 m

PREFIX

Pour tous les profils Prime

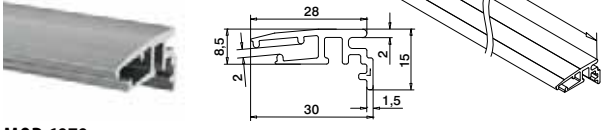

MOD 6979

Aluminium	Brut	
166979-002-50-00		L = 5 m
Aluminium	Brossé, anodisé	
OUTDOOR		
166979-002-50-18		L = 5 m

NEW

PREFIX

Pour les profils Prime **au sol**

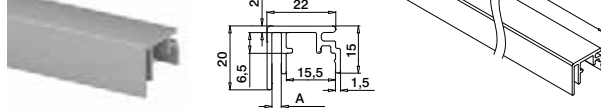

MOD 6970

Aluminium	Brut	
	A	
166970-003-50-00	3	L = 5 m
Aluminium	Brossé, anodisé	
OUTDOOR		
166970-003-50-18	3	L = 5 m

PREFIX

Pour les profils Prime **au sol**

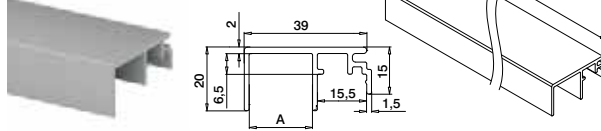

MOD 6970

Aluminium	Brut	
	A	
166970-020-50-00	20	L = 5 m
Aluminium	Brossé, anodisé	
OUTDOOR		
166970-020-50-18	20	L = 5 m

PREFIX

Profil de garde-corps

Outil de montage pour profil de recouvrement / joint de remplissage

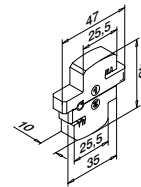

MOD 8405

Accessoires	
208405-010	5



Q-INFO Aluminium

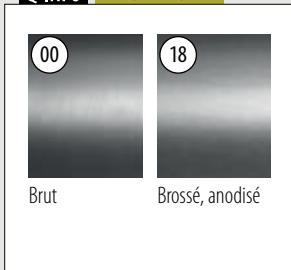

Q-INFO

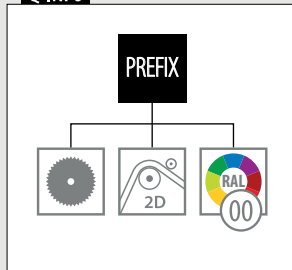

Q-INFO MOD 8405

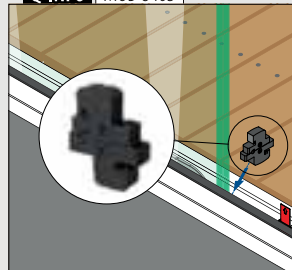

Profils de recouvrement, montage latéral

Pour tous les profils Prime

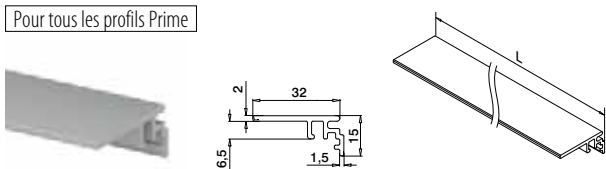

MOD 6973

Aluminium	Brut		
166973-50-00		L = 5 m	
Aluminium	Brossé, anodisé		
OUTDOOR			
166973-50-18		L = 5 m	

PREFIX

Pour les profils Prime **F**,
profils **latéral** et profils en **Y**

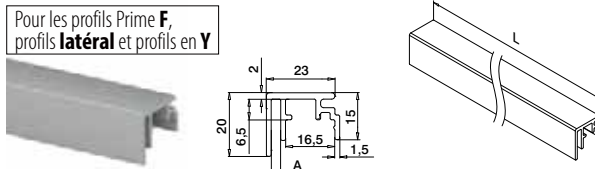

MOD 6974

Aluminium	Brut	A	
166974-003-50-00		3	L = 5 m
Aluminium	Brossé, anodisé		
OUTDOOR			
166974-003-50-18		3	L = 5 m

PREFIX

Pour les profils Prime **F**,
profils **latéral** et profils en **Y**

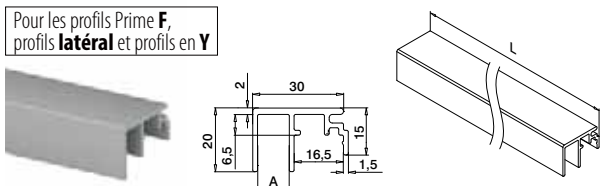

MOD 6974

Aluminium	Brut	A	
166974-010-50-00		10	L = 5 m
Aluminium	Brossé, anodisé		
OUTDOOR			
166974-010-50-18		10	L = 5 m

PREFIX

Pour les profils Prime **F**,
profils **latéral** et profils en **Y**

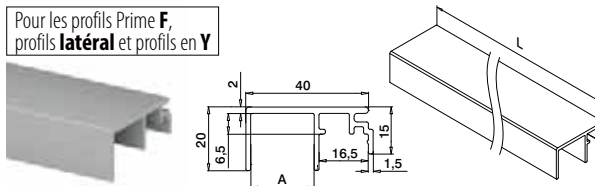

MOD 6974

Aluminium	Brut	A	
166974-020-50-00		20	L = 5 m
Aluminium	Brossé, anodisé		
OUTDOOR			
166974-020-50-18		20	L = 5 m

PREFIX

Q-INFO MOD 6979

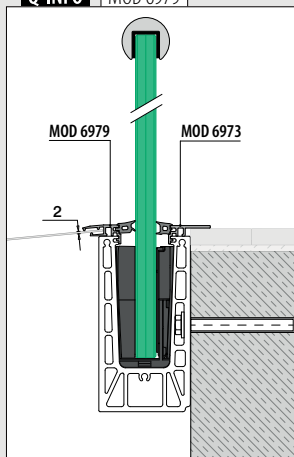

Q-INFO MOD 6970 / 6973

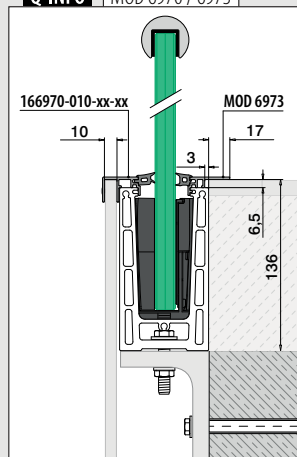

Q-INFO MOD 6974 / 6973

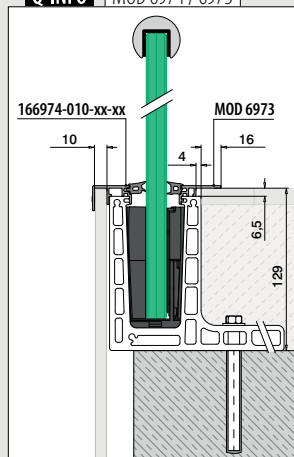

Q-INFO MOD 6974 / 6973

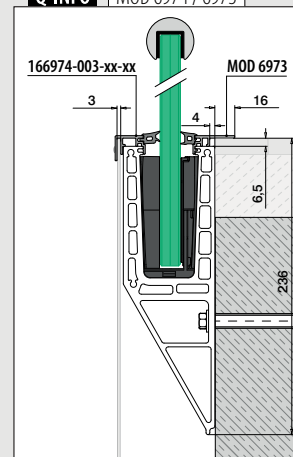



- Conçu pour :** Utilisation pour des contraintes élevées
- Utilisation :** Intérieur et extérieur
- Variantes :** Montage au sol, latéral et engravé
- Applications :** Balcons, galeries, passerelles, cloisons et escaliers
- Matériau :** Aluminium (brossé anodisé et brut)
- Épaisseur de verre :** 21,52 à 33,04 mm

Retrouvez toutes les informations sur Easy Glass Strong en ligne :

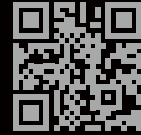

<https://q-ne.ws/Strong23>

EASY GLASS[®] STRONG



reddot winner 2020
innovative product



Un garde-corps solide - facile à monter

Robuste, le système Easy Glass® Strong peut supporter des charges linéaires et des charges de vent importantes. Alliant résistance et fonctionnalité, il est idéal pour les stades, les aéroports, les centres commerciaux et autres lieux publics. Grâce à son Q-disc® System innovant, ce garde-corps en verre est encore plus facile à installer. Montez le profil de sol, positionnez le verre et, d'un simple mouvement de la main, fixez chaque panneau en toute sécurité. La version ajustable du Q-disc System vous permet également d'aligner verticalement chaque panneau de verre. Et bien entendu, nous vous proposons de nombreux éléments compatibles pour la finition de votre garde-corps en verre.

Easy Glass® Strong

Max. charge linéaire (kN/m)

BE

3,0

NBN
803-004

Merci de prendre en considération les spécifications de chaque certificat telles qu'épaisseur du verre, fixation.

Tests/calculs/certificats internationaux:



- 1 Avec le Q-disc System ajustable, vous pouvez réaligner individuellement chacun des panneaux de verre jusqu'à 0,3° à la verticale.
- 2 Le Q-disc vous confirme la bonne installation en émettant des « clics » sonores.
- 3 Adapté au verre trois couches avec film PVB (épaisseurs de verre jusqu'à 33,04 mm).

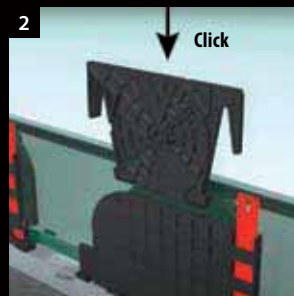
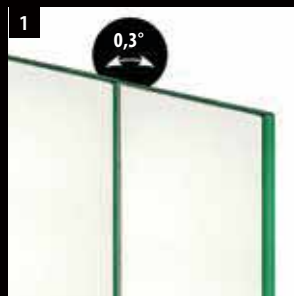

DÉCLINAISONS D'EASY GLASS® STRONG

Strong

Montage au sol

- Également pour scellement au sol

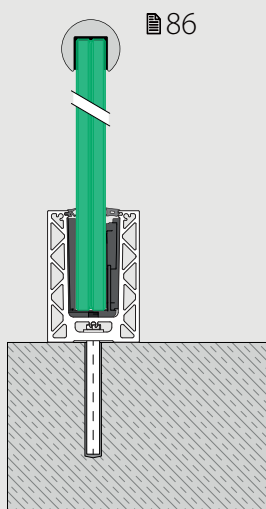

Strong

Montage latéral

- Également pour l'installation sur le côté intérieur des murs de parapet
- Habillages disponibles

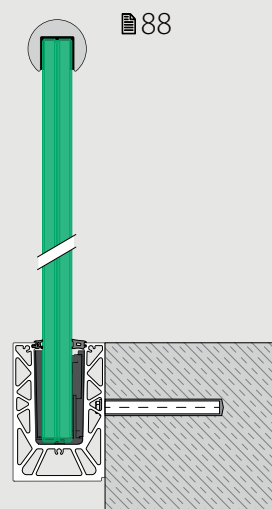

COMING SOON

F et Y profils de sol

Strong F

Montage au sol

- Pour les sols bruts
- Peut aussi s'installer sur le bord d'une surface ou en débord

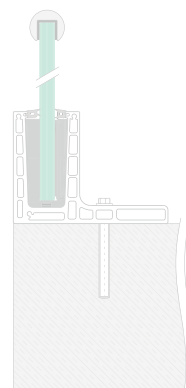

Strong Y

Montage latéral

- Pose latéral
- Peut aussi s'installer sur le bord d'une surface ou en débord

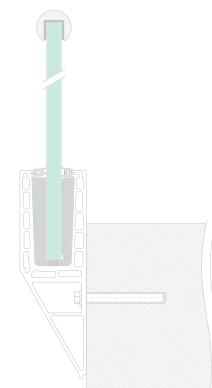



Q-DISC® SYSTEM AJUSTABLE FAITES COULISSER ET ALIGNEZ !



LE PRINCIPE:

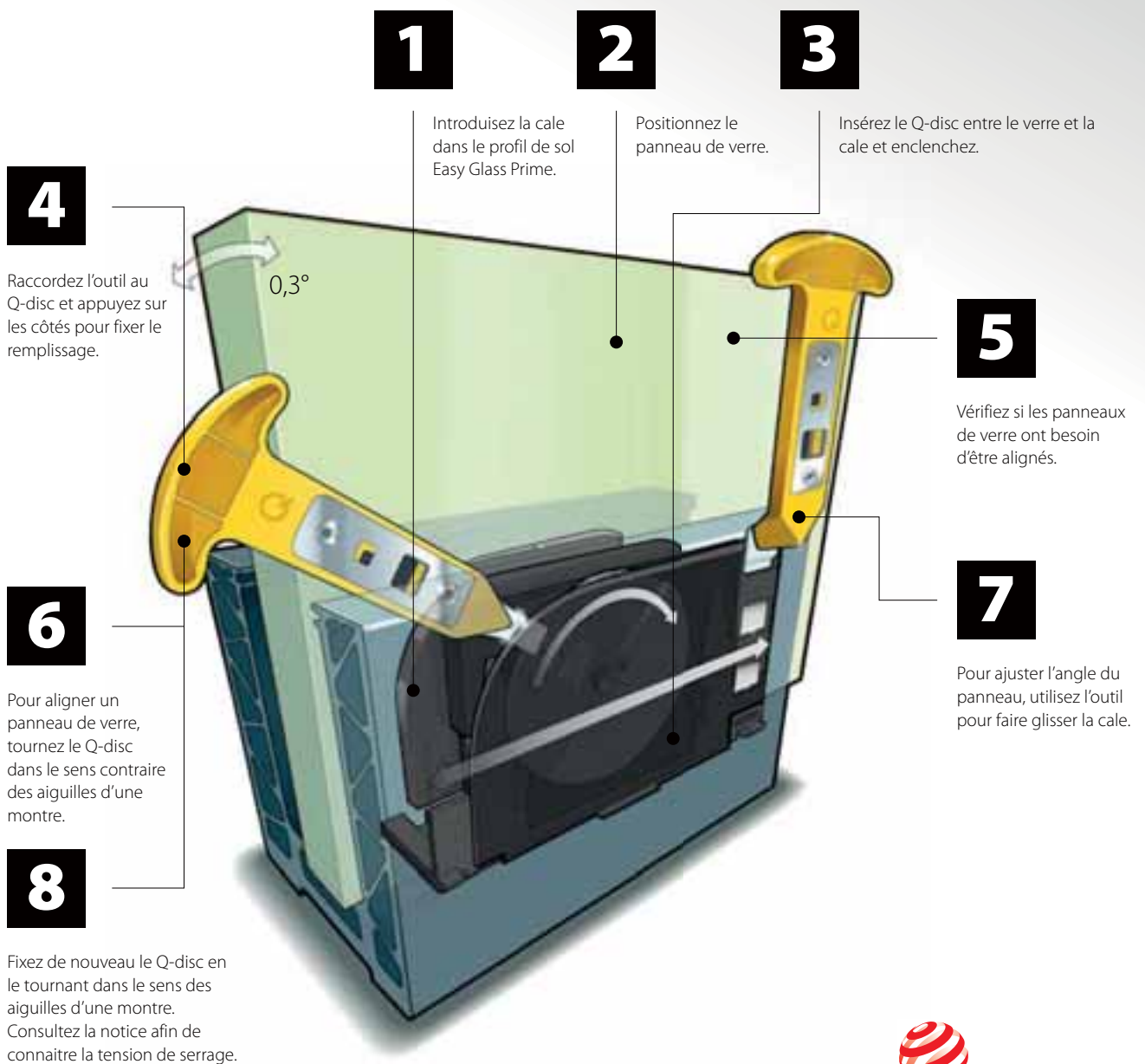

reddot winner 2020
innovative product

Q-disc® System (set de caoutchouc, cale et Q-disc®)

Pour une fixation ajustable du verre

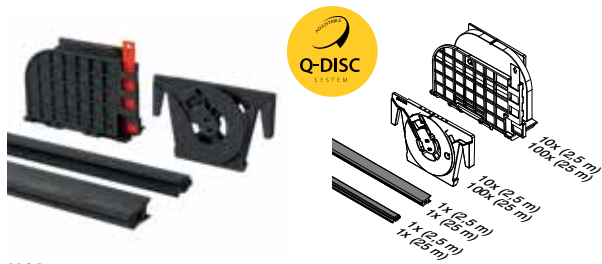

MOD 8601

Accessoires

Pour verre feuilleté	T	
208601-025-22	21,52	L = 2,5 m
208601-025-26	25,52	L = 2,5 m
208601-025-32	31,52	L = 2,5 m
208601-025-34	33,04	L = 2,5 m
208601-250-22	21,52	L = 25 m
208601-250-26	25,52	L = 25 m
208601-250-32	31,52	L = 25 m
208601-250-34	33,04	L = 25 m



International Design Modèle Protection

Accessoires

Outil pour Q-disc® et cale



MOD 1000

Accessoires

	Q	
201000	Q-84	1

Accessoires

Joint de bourrage seuls

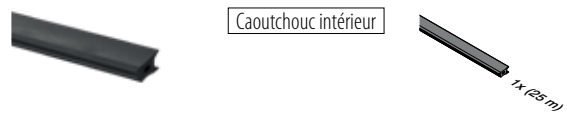

MOD 8207

Accessoires

208207-250-00	L = 25 m
---------------	----------

NEW

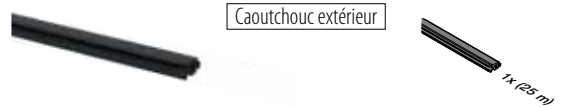

MOD 8607 / 8207

Accessoires

Pour verre feuilleté	T	
208607-250-22	21,52	L = 25 m
208607-250-26	25,52	L = 25 m
208207-250-15	31,52	L = 25 m
208207-250-18	33,04	L = 25 m

NEW

Accessoires

Sets de Q-disc®

Pour une fixation ajustable du verre



MOD 8609

Accessoires

	T	
208609-22	21,52	5
208609-26	25,52	5
208609-32	31,52	5
208609-34	33,04	5

NEW



Q-INFO MOD 1000

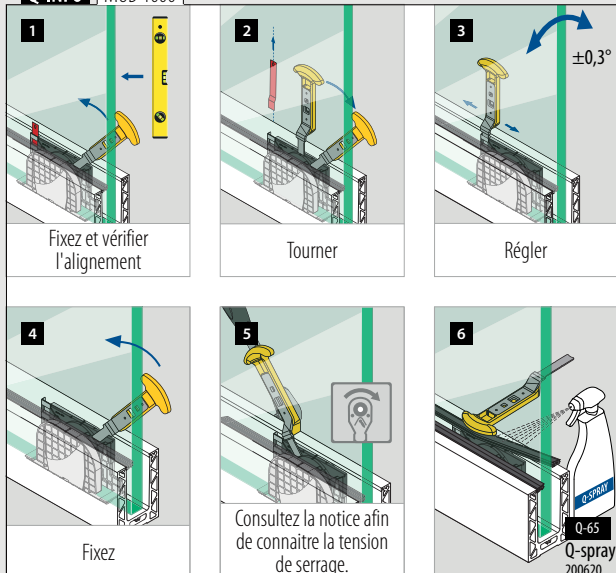

Q-INFO

Guide pour verre

MOD 1002

480



Profil de garde-corps

Profil de sol, montage au sol

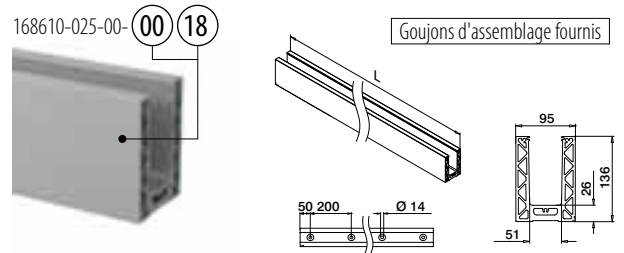
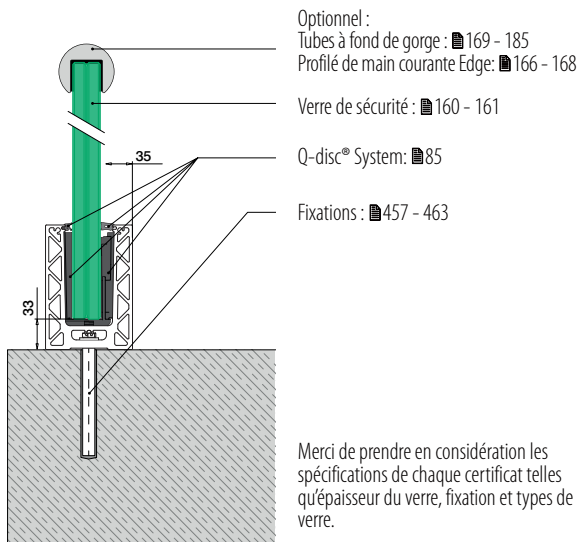

MOD 8610

Aluminium	Brut		
168610-025-00-00	457 - 463		L = 2,5 m
Aluminium	Brossé, anodisé		
OUTDOOR			
168610-025-00-18	457 - 463		L = 2,5 m



Profil de garde-corps

Angles, montage au sol

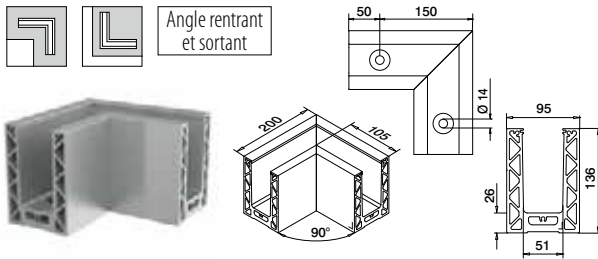

MOD 8611

Aluminium	Brut		
168611-00-00	457 - 463		1
Aluminium	Brossé, anodisé		
OUTDOOR			
168611-00-18	457 - 463		1



International Design Modèle Protection

Q-INFO MOD 8610

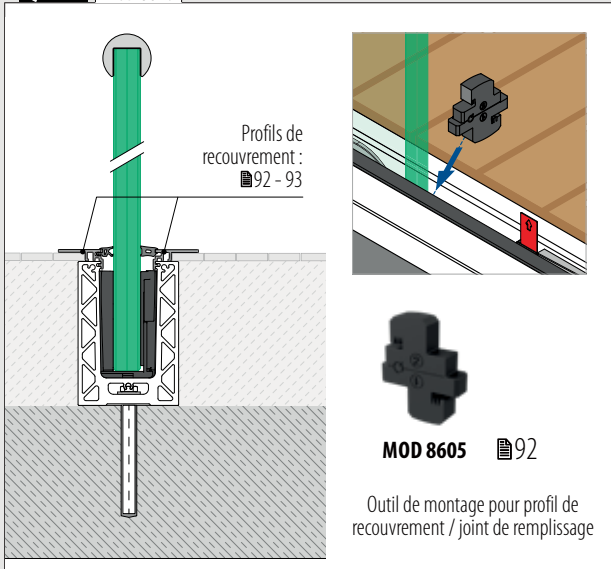

Q-INFO MOD 8610

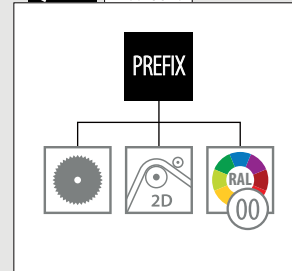

Q-INFO Aluminium



Q-INFO

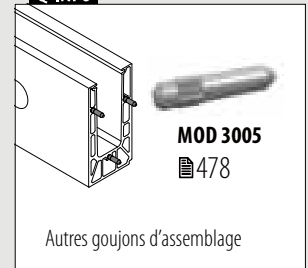

Embouts, montage au sol



MOD 8612

Aluminium	Brut		
Ruban adhésif			
168612-00-00	Fourni	1	
Aluminium	Brossé, anodisé		
OUTDOOR			
168612-00-18	Pré-collé	1	

NEW

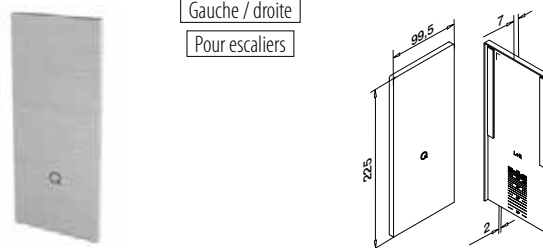

MOD 8613

Aluminium	Brut		
Ruban adhésif			
168613-00-00	Fourni	1	
Aluminium	Brossé, anodisé		
OUTDOOR			
168613-00-18	Pré-collé	1	

NEW

Cale, montage au sol

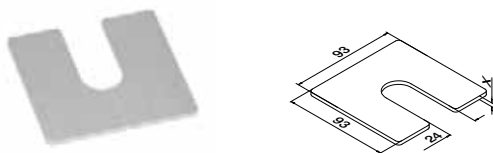

MOD 8616

Aluminium	Brut		
	X		
168616-001	1	100	
168616-002	2	100	
168616-003	3	100	

NEW

Profils de drainage, montage au sol

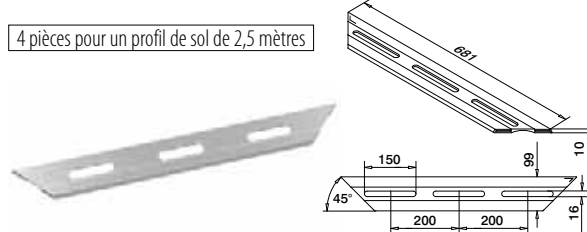

MOD 8617

Aluminium	Brossé, anodisé		
OUTDOOR			
168617-18		4	

NEW

Q-INFO MOD 8612

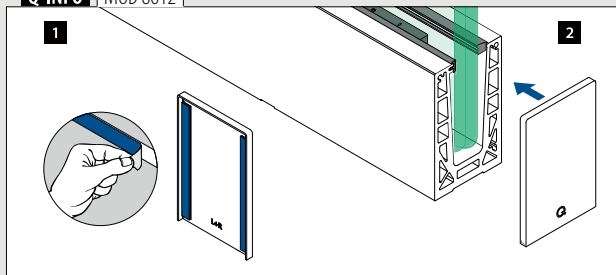

Q-INFO MOD 8613

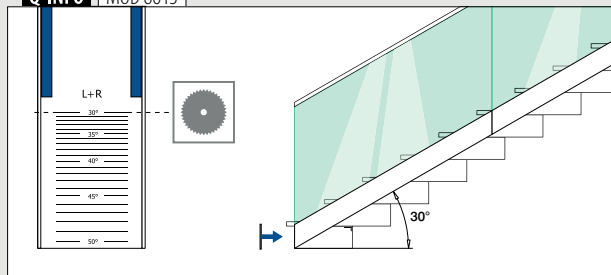

Q-INFO MOD 8616

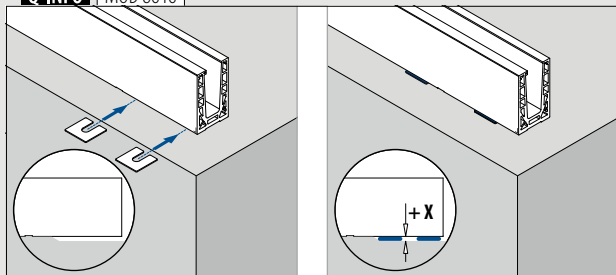

Q-INFO MOD 8617



Informations sur l'assemblage :



<https://q-ne.ws/Strong23>

Profil de garde-corps

Profil de sol, montage latéral

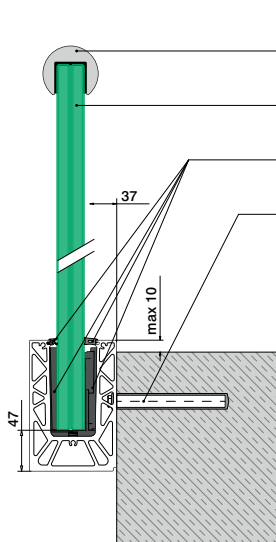

- Optionnel :
Tubes à fond de gorge : █ 169 - 185
Profilé de main courante Edge: █ 166 - 168
- Verre de sécurité : █ 160 - 161
- Q-disc® System: █ 85
- Fixations : █ 457 - 463

Merci de prendre en considération les spécifications de chaque certificat telles qu'épaisseur du verre, fixation et types de verre.

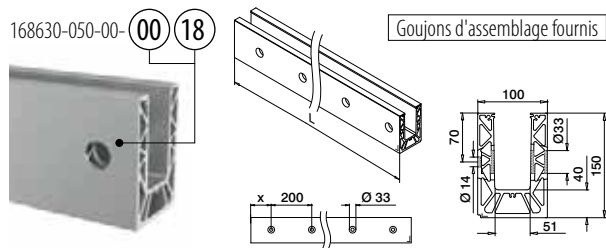

MOD 8630

Aluminium	Brut	X	█ 457 - 463	L = 2,5 m
168630-050-00	100			
Aluminium	Brossé, anodisé	OUTDOOR		
168630-025-00-18	100		█ 457 - 463	L = 2,5 m



International Design
Modèle Protection

Profil de garde-corps

Angles, montage latéral

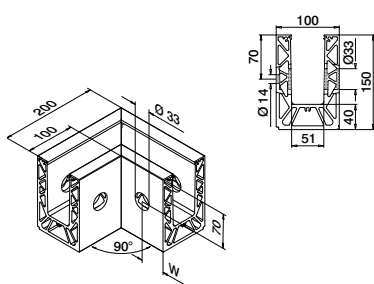

MOD 8631

Aluminium	Brut	W	█ 457 - 463	1
168631-01-00	50*			
Aluminium	Brossé, anodisé	OUTDOOR		
168631-01-18	50*		█ 457 - 463	1

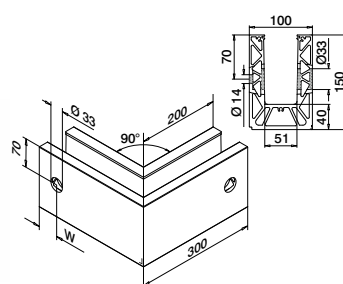
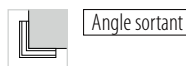

MOD 8631

Aluminium	Brut	W	█ 457 - 463	1
168631-02-00	50*			
Aluminium	Brossé, anodisé	OUTDOOR		
168631-02-18	50*		█ 457 - 463	1



*La position du trou peut varier en raison de la technique de production.

Q-INFO MOD 8630

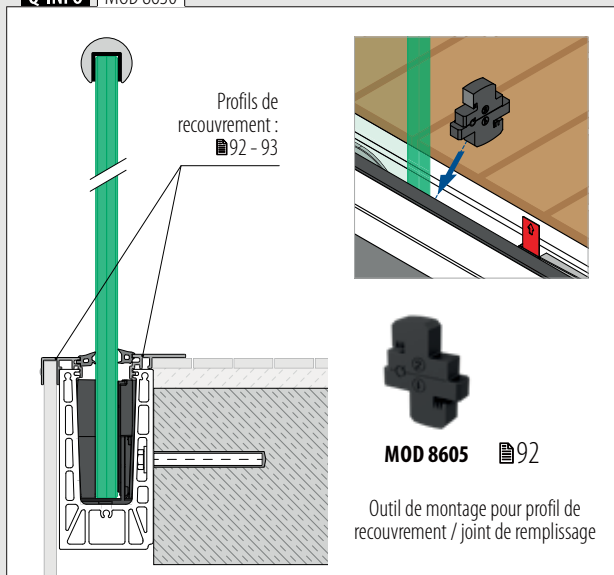

MOD 8605 █ 92

Outil de montage pour profil de recouvrement / joint de remplissage

Q-INFO MOD 8630

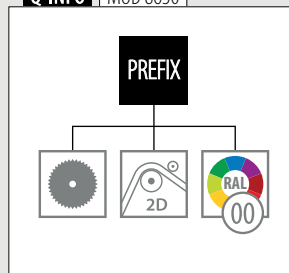

Q-INFO Aluminium



00	18
Brut	Brossé, anodisé

Q-INFO

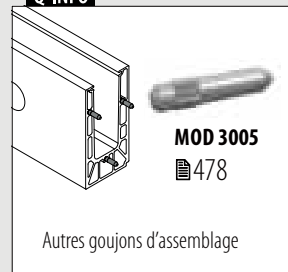

MOD 3005
█ 478

Autres goujons d'assemblage

Embouts, montage latéral

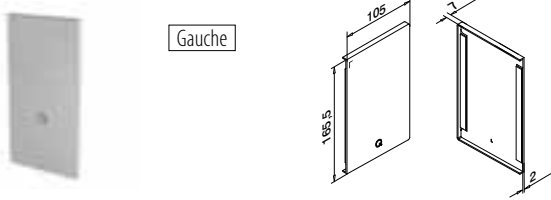

Gauche

MOD 8632

Aluminium	Brut		
	Ruban adhésif		
168632-41-00	Fourni		1
Aluminium	Brossé, anodisé		
OUTDOOR			
168632-41-18	Pré-collé		1

NEW

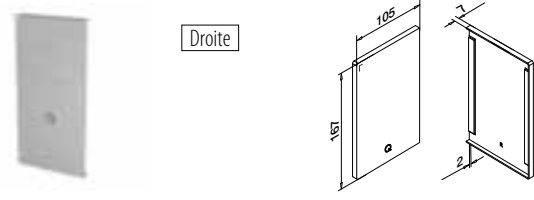

Droite

MOD 8632

Aluminium	Brut		
	Ruban adhésif		
168632-42-00	Fourni		1
Aluminium	Brossé, anodisé		
OUTDOOR			
168632-42-18	Pré-collé		1

NEW

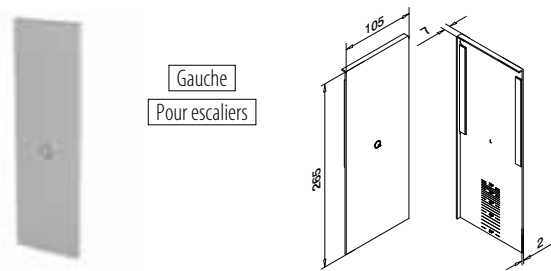

Gauche
Pour escaliers

MOD 8633

Aluminium	Brossé, anodisé		
OUTDOOR	Ruban adhésif		
168633-41-18	Pré-collé		1

NEW

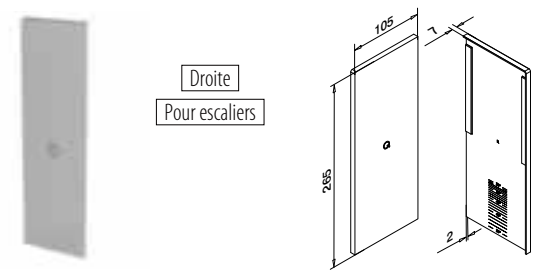

Droite
Pour escaliers

MOD 8633

Aluminium	Brossé, anodisé		
OUTDOOR	Ruban adhésif		
168633-42-18	Pré-collé		1

NEW



Profil de garde-corps

Profils de drainage, montage latéral

4 pièces pour un profil de sol de 2,5 mètres

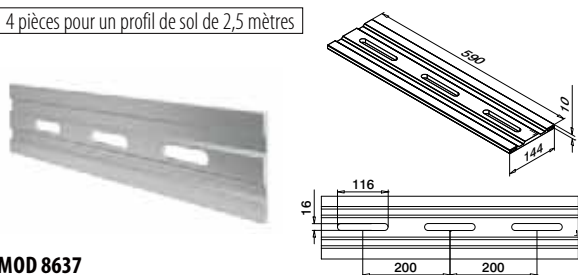

MOD 8637

Aluminium Brosse, anodisé

OUTDOOR



168637-18

4

NEW

Profil de garde-corps

Cale, montage latéral

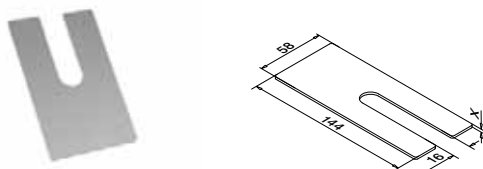

MOD 8636

Aluminium Brut

X



168636-001

1

100

168636-002

2

100

168636-003

3

100

NEW

Q-INFO MOD 8637

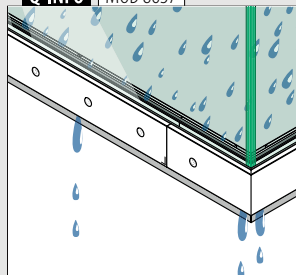

Informations sur l'assemblage :



<https://q-ne.ws/Strong23>

Q-INFO MOD 8636

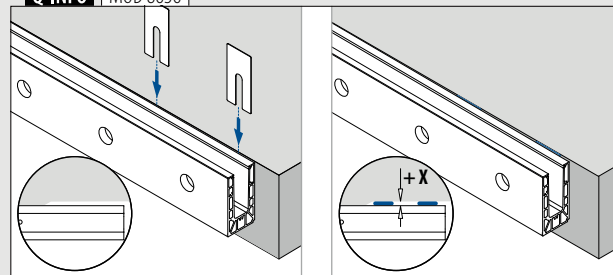

Embouts, montage latéral

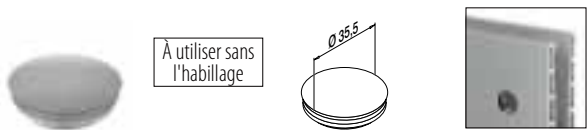

À utiliser sans l'habillage

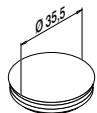

MOD 8238

Plastique	Aluminium blanc RAL 9006
INDOOR	
158238-36	10

Habillage, montage latéral

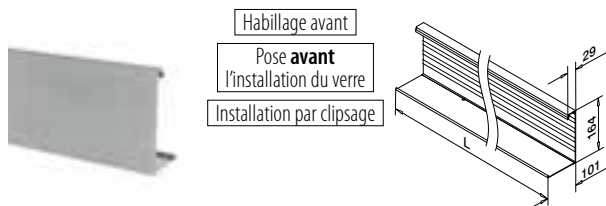

Habillage avant
Pose **avant**
l'installation du verre
Installation par clipsage

MOD 8634

Aluminium	Brut
	
168634-050-00	L = 5 m
Aluminium	Brossé, anodisé
OUTDOOR	
168634-050-18	L = 5 m



Q-INFO MOD 8238

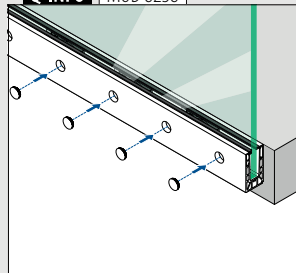

Q-INFO Aluminium

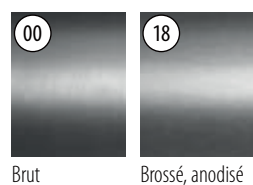

Q-INFO MOD 8634

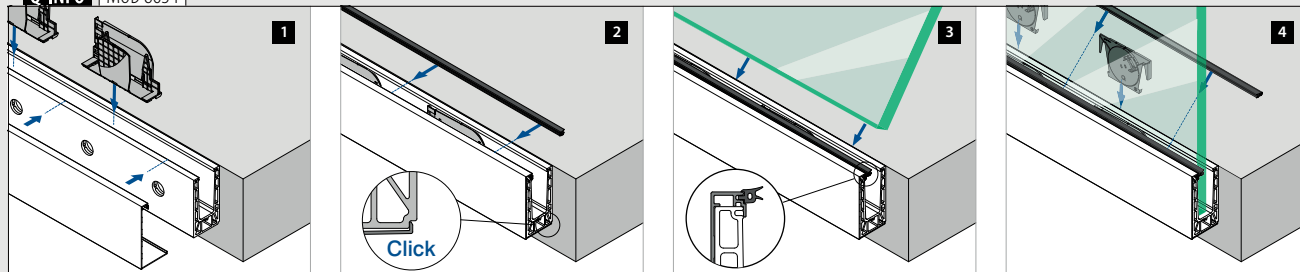

Profil de garde-corps

Profils de recouvrement, montage au sol

Pour tous les profils Strong

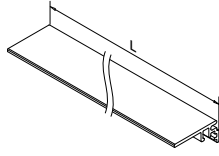
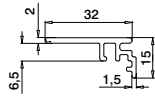

MOD 6973

Aluminium	Brut	
166973-50-00		L = 5 m
Aluminium	Brossé, anodisé	
OUTDOOR		
166973-50-18		L = 5 m

PREFIX

Pour les profils Strong **au sol**

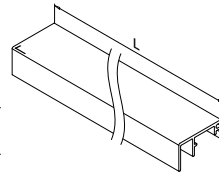
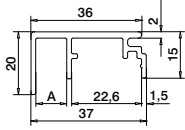

MOD 6975

Aluminium	Brut	
	A	L = 5 m
166975-010-50-00	10	L = 5 m
Aluminium	Brossé, anodisé	
OUTDOOR		
166975-010-50-18	10	L = 5 m

NEW PREFIX

Pour tous les profils Strong

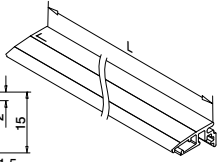
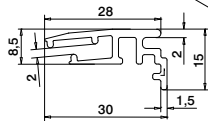

MOD 6979

Aluminium	Brut	
166979-002-50-00		L = 5 m
Aluminium	Brossé, anodisé	
OUTDOOR		
166979-002-50-18		L = 5 m

NEW PREFIX

Pour les profils Strong **au sol**

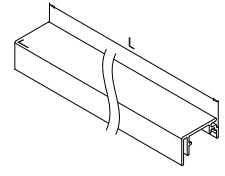
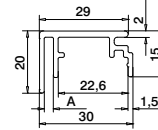

MOD 6975

Aluminium	Brut	
	A	L = 5 m
166975-003-50-00	3	L = 5 m
Aluminium	Brossé, anodisé	
OUTDOOR		
166975-003-50-18	3	L = 5 m

NEW PREFIX

Pour les profils Strong **au sol**

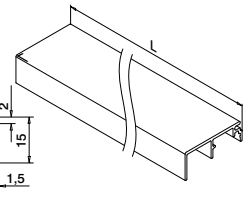
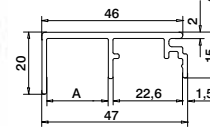

MOD 6975

Aluminium	Brut	
	A	L = 5 m
166975-020-50-00	20	L = 5 m
Aluminium	Brossé, anodisé	
OUTDOOR		
166975-020-50-18	20	L = 5 m

NEW PREFIX

Profil de garde-corps

Outil de montage pour profil de recouvrement / joint de remplissage

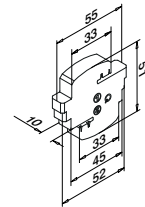

MOD 8605

Accessoires	
208605-010	5

NEW

Q-INFO Aluminium

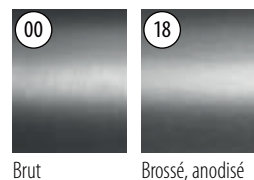

Q-INFO

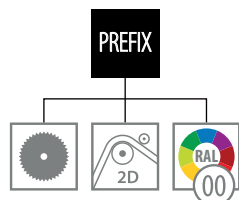

Q-INFO MOD 8605

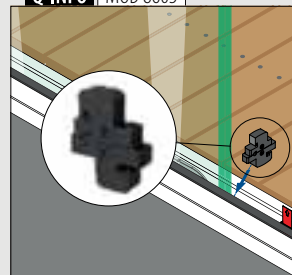

Profils de recouvrement, montage latéral

Pour tous les profils Strong

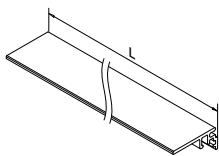
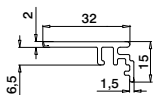

MOD 6973

Aluminium	Brut		
166973-50-00		L = 5 m	
Aluminium	Brossé, anodisé		
OUTDOOR			
166973-50-18		L = 5 m	

PREFIX

Pour les profils latéral

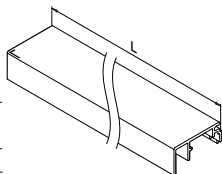
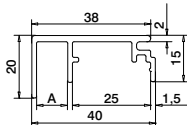

MOD 6977

Aluminium	Brut		
	A		
166977-010-50-00	10	L = 5 m	
Aluminium	Brossé, anodisé		
OUTDOOR			
166977-010-50-18	10	L = 5 m	

NEW

PREFIX

Pour les profils latéral

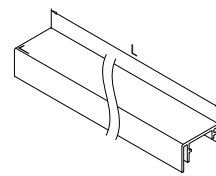
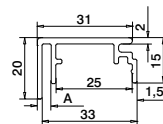

MOD 6977

Aluminium	Brut		
	A		
166977-003-50-00	3	L = 5 m	
Aluminium	Brossé, anodisé		
OUTDOOR			
166977-003-50-18	3	L = 5 m	

NEW

PREFIX

Pour les profils latéral

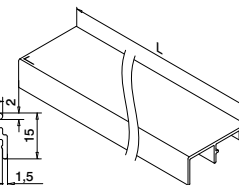
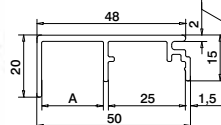

MOD 6977

Aluminium	Brut		
	A		
166977-020-50-00	20	L = 5 m	
Aluminium	Brossé, anodisé		
OUTDOOR			
166977-020-50-18	20	L = 5 m	

NEW

PREFIX

Q-INFO MOD 6979

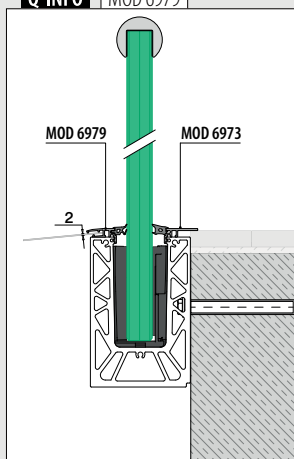

Q-INFO MOD 6975 / 6973

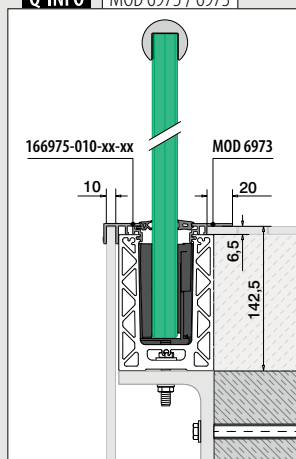

Q-INFO MOD 6977 / 6973

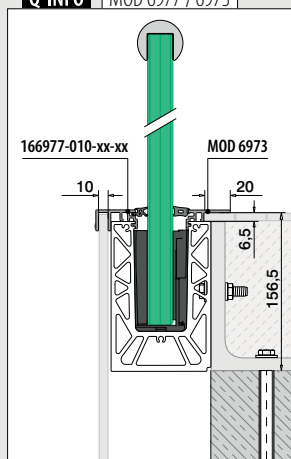



Conçu pour : Utilisation faible à moyenne
Utilisation : Intérieur et extérieur
Variantes : Montage au sol, latéral et engravé
Applications : Balcons, galeries, passerelles, cloisons, escaliers et pare-vents
Matériau : Aluminium (brut ou brossé, anodisé)
Épaisseur de verre : 12 à 21,52 mm

Retrouvez toutes les informations sur Easy Glass Slim en ligne :



<https://q-ne.ws/Slim23>

EASY GLASS[®] SLIM

La finesse d'un profil au service d'une transparence maximale



Easy Glass® Slim fait parti des classiques de notre gamme de garde-corps en verre. Résidence privée, bureau ou espace public : ce système de garde-corps en verre constitue une solution abordable quel que soit votre projet. Son esthétique minimaliste comprend un profil de sol fin conférant une apparence élégante à ce garde-corps tout en minimisant son poids. Easy Glass Slim vous permettra de réaliser vos projets de garde-corps bombés et vos escaliers débarrassés en remplissage en verre.

Easy Glass® Slim	BE
Max. charge linéaire (kN/m)	1,0

Merci de prendre en considération les spécifications de chaque certificat telles qu'épaisseur du verre, fixation.

Tests/calculs/certificats internationaux:



- 1 Avec seulement 45 mm d'épaisseur, le profil de sol du garde-corps Easy Glass Slim est une solution économique offrant un rendu élégant.
- 2 Ce profil de sol est léger et facile à manier, ce qui le rend idéal pour l'installation sur le chantier.

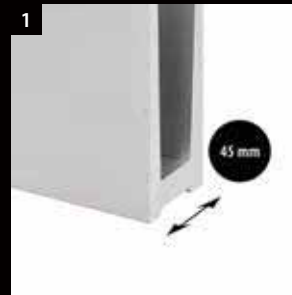

DÉCLINAISONS D'EASY GLASS® SLIM

Slim

Montage au sol

- Également pour scellement au sol

97

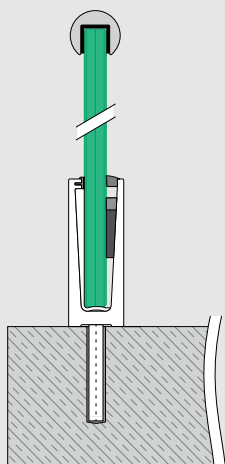

Slim F

Montage au sol

- Pour les sols bruts
- Peut aussi s'installer en nez de dalle

99

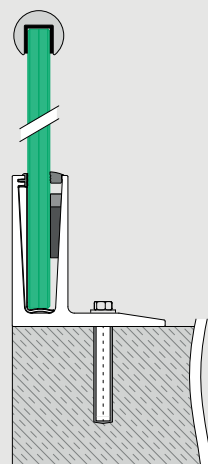

Slim

Montage latéral

- Cache de profil de sol en option

100

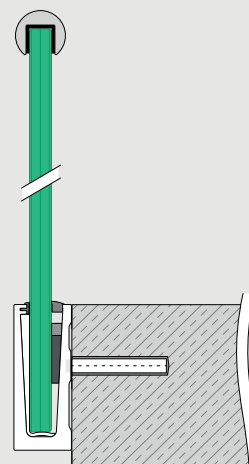

Profil de garde-corps

Safety Wedge System (set de cales en caoutchouc)

Pour une fixation du verre

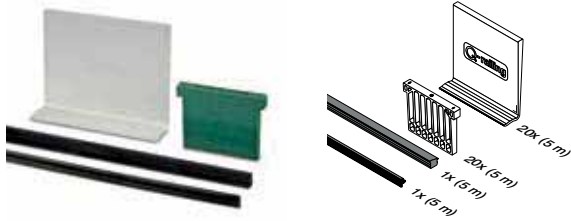

MOD 8000

Accessoires

Pour verre monolithique	T	
208000-050-12	12	L = 5 m
208000-050-15	15	L = 5 m
208000-050-19	19	L = 5 m

Pour verre feuilleté

208000-050-13	12,76	L = 5 m
208000-050-14	13,52	L = 5 m
208000-050-17	16,76	L = 5 m
208000-050-18	17,52	L = 5 m
208000-050-21	20,76	L = 5 m
208000-050-22	21,52	L = 5 m

Accessoires

Outil multi-fonctions Easy Glass®



MOD 1001

Accessoires

	Q	
201001	Q-71	1

Profil de garde-corps

Joint de remplissage

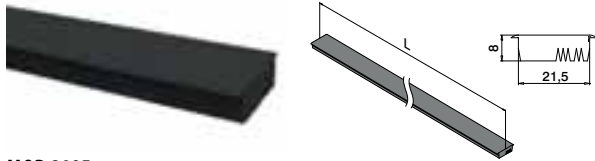

MOD 8105

Accessoires

	208105-025		L = 2,5 m
--	------------	--	-----------



Seulement jusqu'à épuisement des stocks.

Q-INFO MOD 8105

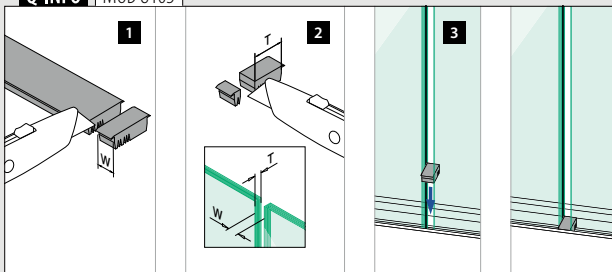

Q-INFO MOD 1001

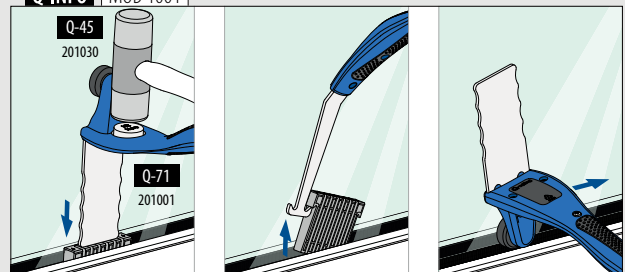

Profil de sol, montage au sol

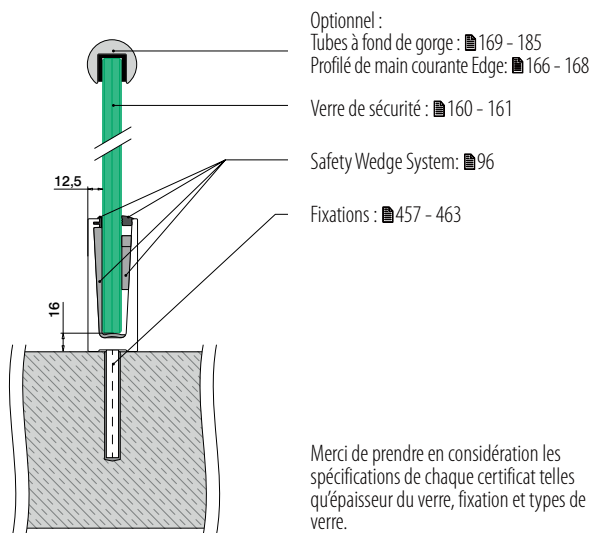

Merci de prendre en considération les spécifications de chaque certificat telles qu'épaisseur du verre, fixation et types de verre.

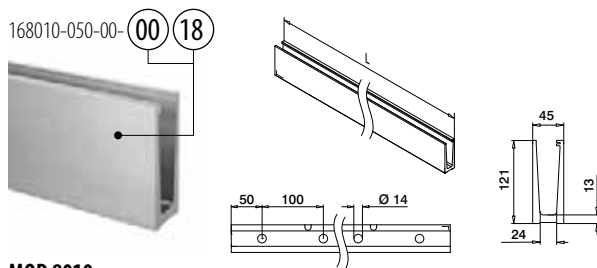

MOD 8010

Aluminium Brut

NEW 168010-050-00-00 457 - 463 L = 5 m

Aluminium Brossé, anodisé

OUTDOOR

SELL OUT 168010-050-00-18 457 - 463 L = 5 m

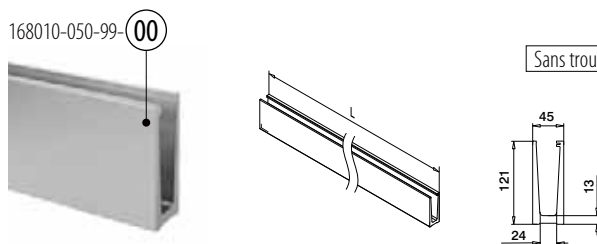

MOD 8010

Aluminium Brut

SELL OUT 168010-050-99-00 L = 5 m



Angles, montage au sol

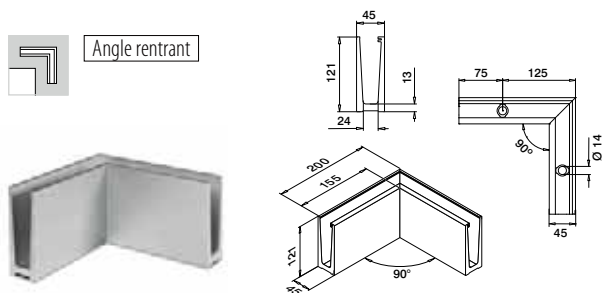

MOD 8011

Aluminium Brossé, anodisé

OUTDOOR

SELL OUT 168011-01-18 457 - 463 1

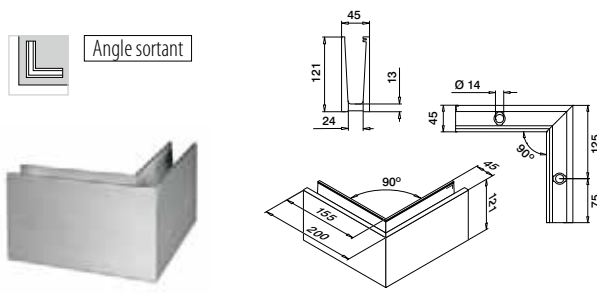

MOD 8011

Aluminium Brossé, anodisé

OUTDOOR

SELL OUT 168011-02-18 457 - 463 1



Q-INFO MOD 8010

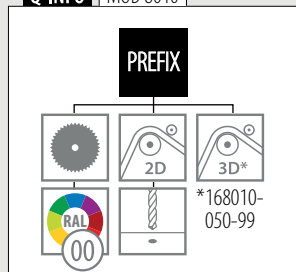

Q-INFO

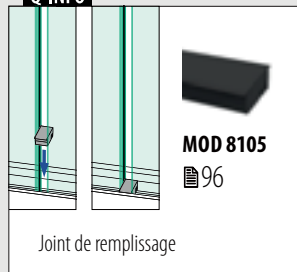

Q-INFO Aluminium



Profil de garde-corps

Embouts, montage au sol

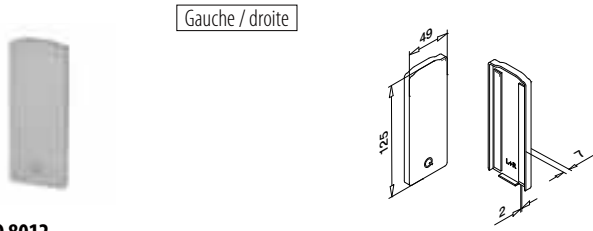

Gauche / droite

MOD 8012

Aluminium Brut

Ruban adhésif



SELL OUT	168012-00-00	Fourni	1
-------------	--------------	--------	---

Aluminium Brosé, anodisé

OUTDOOR

SELL OUT	168012-00-18	Pré-collé	1
-------------	--------------	-----------	---

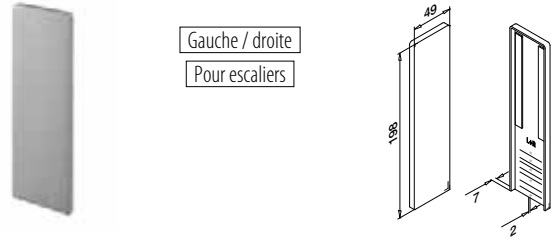

Gauche / droite

Pour escaliers

MOD 8013

Aluminium Brosé, anodisé

OUTDOOR **Ruban adhésif**



SELL OUT	168013-00-18	Pré-collé	1
-------------	--------------	-----------	---



Profil de garde-corps

Profils de drainage, montage au sol

Pour un profil de sol de 2,5 m

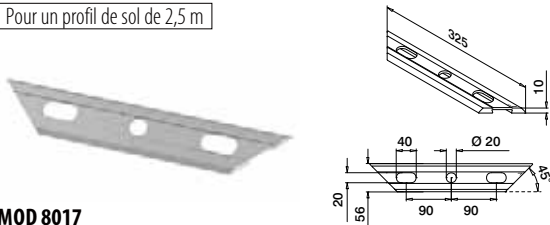

MOD 8017

Aluminium Brosé, anodisé

OUTDOOR

SELL OUT	168017-18		8
-------------	-----------	--	---

International Design Modèle Protection

Q-INFO MOD 8017

Informations sur l'assemblage :

<https://q-ne.ws/Slim23>

Q-INFO Aluminium

00	18
Brut	Brosé, anodisé

Q-INFO MOD 8012

Q-INFO MOD 8013

Profil de garde-corps

Profil de sol, montage au sol

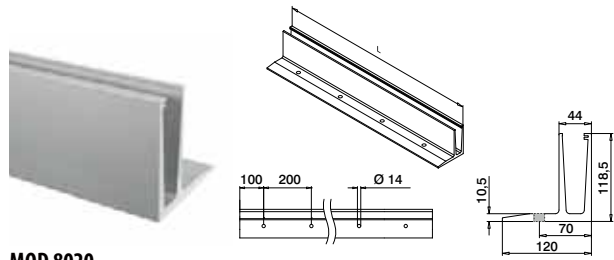
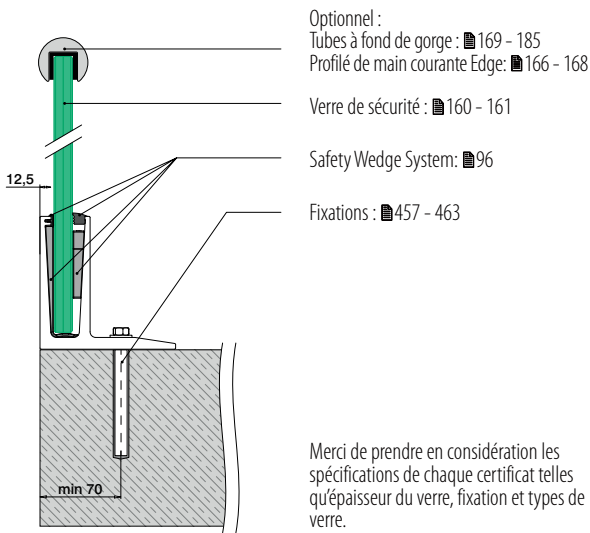

MOD 8020

Aluminium Brossé, anodisé

OUTDOOR

SELL OUT 168020-050-00-18 457 - 463 L = 5 m



Profil de garde-corps

Angles, montage au sol

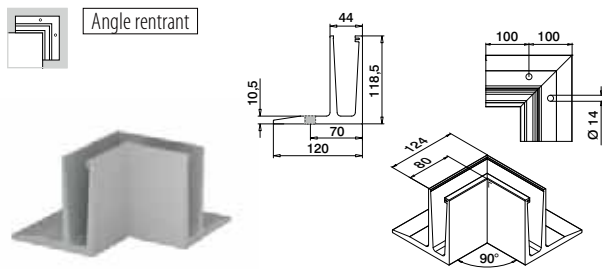

MOD 8021

Aluminium Brossé, anodisé

OUTDOOR

SELL OUT 168021-01-18 457 - 463 1

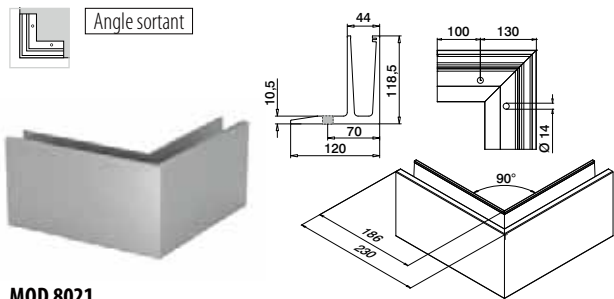

MOD 8021

Aluminium Brossé, anodisé

OUTDOOR

SELL OUT 168021-02-18 457 - 463 1



Profil de garde-corps

Embouts, montage au sol

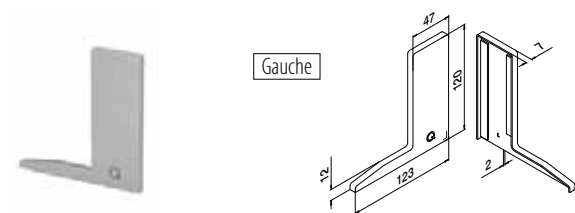

MOD 8022

Aluminium Brossé, anodisé

OUTDOOR

Ruban adhésif

SELL OUT 168022-01-18 Pré-collé 1

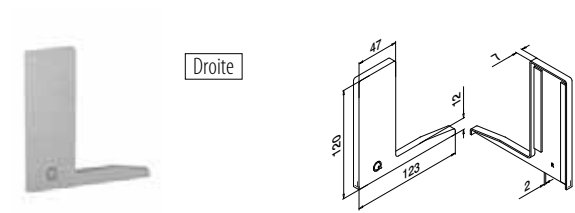

MOD 8022

Aluminium Brossé, anodisé

OUTDOOR

Ruban adhésif

SELL OUT 168022-02-18 Pré-collé 1

Q-INFO MOD 8020

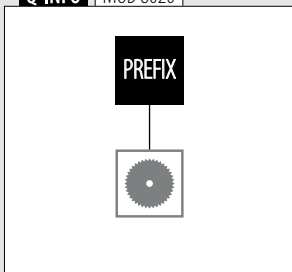

Q-INFO

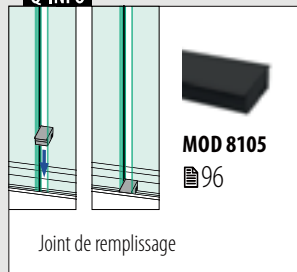

Q-INFO MOD 8022

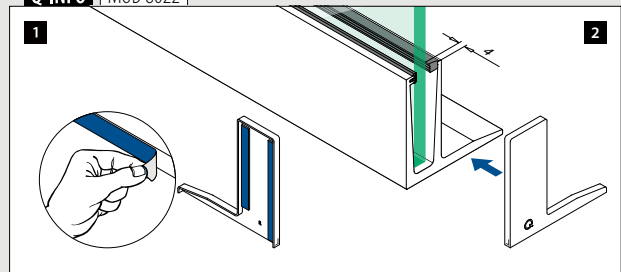

Profil de garde-corps

Profil de sol, montage latéral

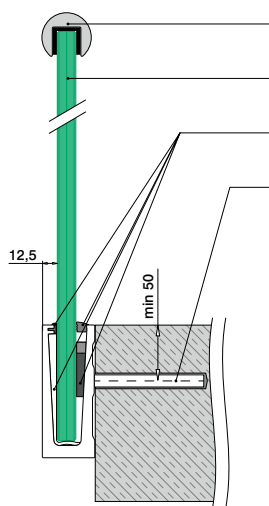

- Optionnel :
 Tubes à fond de gorge : █ 169 - 185
 Profilé de main courante Edge: █ 166 - 168
 Verre de sécurité : █ 160 - 161
 Safety Wedge System: █ 96
 Fixations : █ 457 - 463

Merci de prendre en considération les spécifications de chaque certificat telles qu'épaisseur du verre, fixation et types de verre.

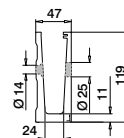
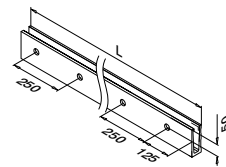

MOD 8030

Aluminium Brosse, anodisé

OUTDOOR

SELL OUT 168030-050-00-18 █ 457 - 463 L = 5 m



Profil de garde-corps

Angles, montage latéral

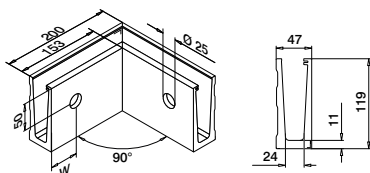

MOD 8031

Aluminium Brosse, anodisé

OUTDOOR

W

█ 457 - 463 1

SELL OUT

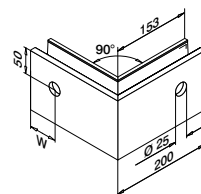

MOD 8031

Aluminium Brosse, anodisé

OUTDOOR

W

█ 457 - 463 1

SELL OUT



*La position du trou peut varier en raison de la technique de production.

Q-INFO MOD 8030

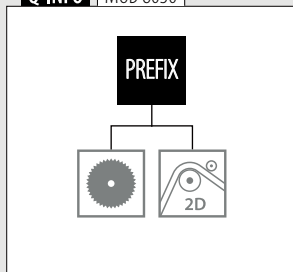

Q-INFO

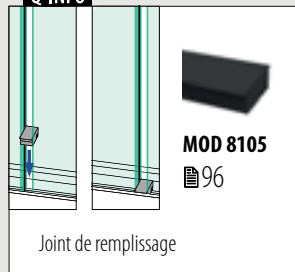

SELL OUT Seulement jusqu'à épuisement des stocks.

Embout, montage latéral



Gauche
À utiliser avec l'habillage

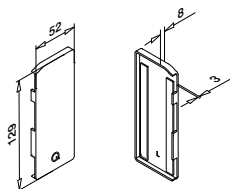

MOD 8034

Aluminium Brosse, anodisé

OUTDOOR

Ruban adhésif



SELL OUT 168034-01-18

Pré-collé

1



Droite
À utiliser avec l'habillage

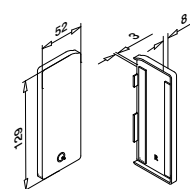

MOD 8034

Aluminium Brosse, anodisé

OUTDOOR

Ruban adhésif



SELL OUT 168034-02-18

Pré-collé

1



Gauche
À utiliser sans l'habillage

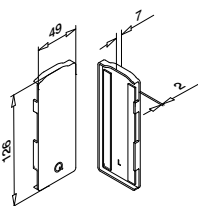

MOD 8032

Aluminium Brosse, anodisé

OUTDOOR

Ruban adhésif



SELL OUT 168032-01-18

Pré-collé

1



Droite
À utiliser sans l'habillage

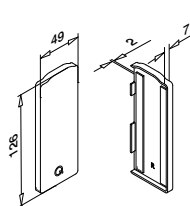

MOD 8032

Aluminium Brosse, anodisé

OUTDOOR

Ruban adhésif



SELL OUT 168032-02-18

Pré-collé

1



Gauche
À utiliser avec ou sans l'habillage
Pour escaliers

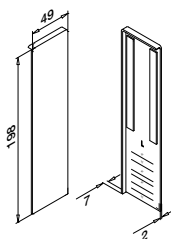

MOD 8033

Aluminium Brosse, anodisé

OUTDOOR

Ruban adhésif



SELL OUT 168033-01-18

Pré-collé

1



Droite
À utiliser avec ou sans l'habillage
Pour escaliers

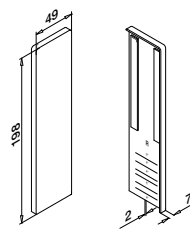

MOD 8033

Aluminium Brosse, anodisé

OUTDOOR

Ruban adhésif



SELL OUT 168033-02-18

Pré-collé

1



Q-INFO MOD 8032 / 8034

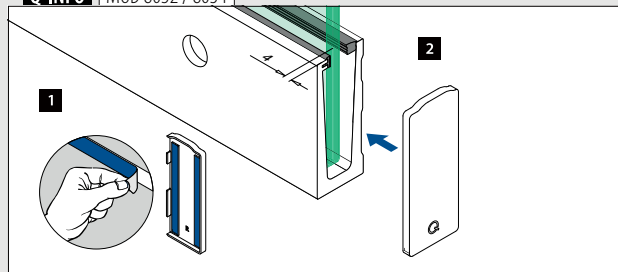

Q-INFO MOD 8033

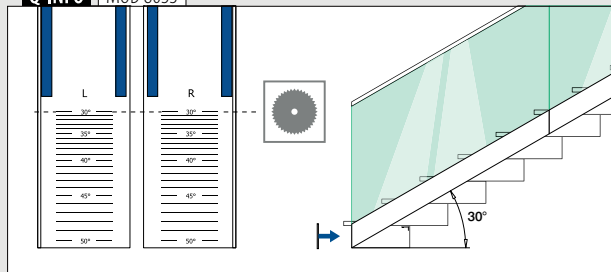

Profil de garde-corps

Habillage, montage latéral



MOD 8035

Aluminium	Brossé, anodisé
OUTDOOR	Ruban adhésif
168035-025-18	Pré-collé
	L = 2,5 m

SELL
OUT

Profil de garde-corps

Embouts, montage latéral

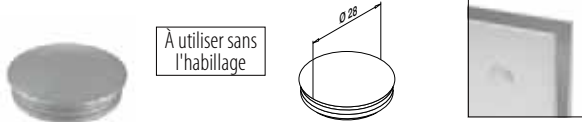

MOD 8038

Plastique	Aluminium blanc RAL 9006
INDOOR	
158038-36	10

SELL
OUT

SELL
OUT

Seulement jusqu'à épaisseur des stocks.

Q-INFO | MOD 8035

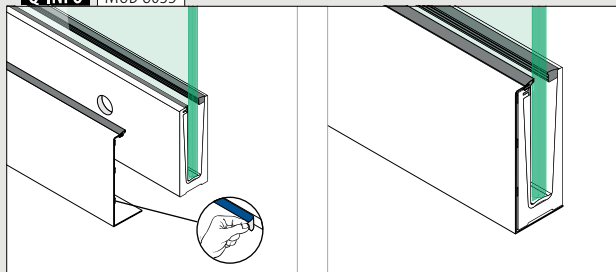

Q-INFO | MOD 8038

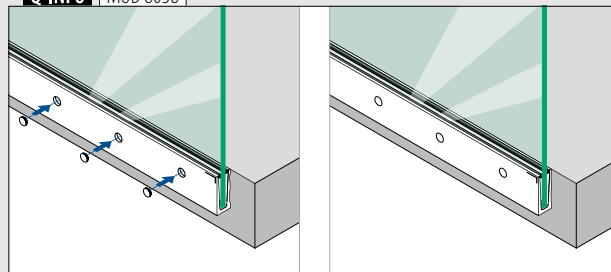





Conçu pour : Utilisation faible à moyenne
Utilisation : Intérieur et extérieur
Variantes : Montage au sol, latéral et engravé
Applications : Balcons, galeries, passerelles, cloisons, escaliers et pare-vents
Matériau : Aluminium (brut ou brossé, anodisé)
Épaisseur de verre : 12 à 21,52 mm

Retrouvez toutes les informations sur Easy Glass Pro en ligne :



<https://q-ne.ws/Pro23>

EASY GLASS® PRO

Effectuez toute l'installation du côté intérieur du garde-corps



Le profil de sol Easy Glass® Pro est facile à installer. En outre, le Safety Wedge System constitué de cales en caoutchouc ajustables facilite également l'alignement du verre en vous permettant d'ajuster chaque panneau de manière indépendante jusqu'à 10 mm à la verticale. Et avec quatre variantes de profils, vous êtes certains de trouver une solution Pro adaptée aux contraintes de votre projet. Le système Easy Glass® Pro est justifié pour une utilisation en pare-vent jusqu'à 2,08 m (voir Avis Technique).

Easy Glass® Pro	BE
Max. charge linéaire (kN/m)	1,0



Merci de prendre en considération les spécifications de chaque certificat telles qu'épaisseur du verre, fixation.

Tests/calculs/certificats internationaux:



- 1 Faites votre choix parmi une sélection de 4 profils de sol. Vous trouverez à coup sûr celui qui convient à votre projet. Le garde-corps Easy Glass Pro s'adapte à toutes les situations de montage, y compris les plus complexes.
- 2 Chacun des panneaux de verre peut être ajusté jusqu'à 10 mm (1°) dans toutes les directions, et ce depuis l'intérieur du garde-corps.



DÉCLINAISONS D'EASY GLASS® PRO

Pro

Montage au sol

- Également pour scellement au sol

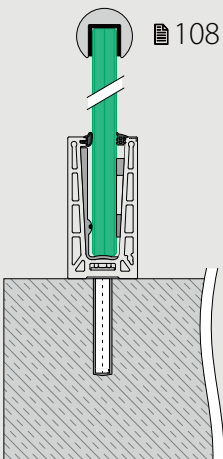

Pro F

Montage au sol

- Pour les sols bruts
- Peut aussi s'installer sur ou au-dessus de la bordure d'une surface

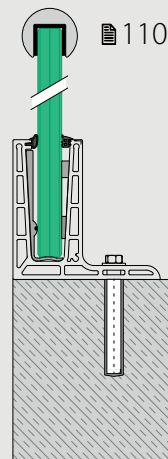

Pro

Montage latéral

- Cache de profil de sol en option

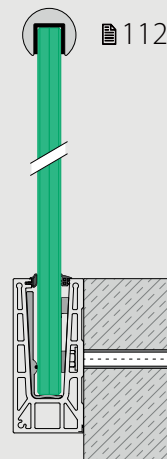

Pro Y

Montage latéral

- Pose latéral
- Peut aussi s'installer sur ou au-dessus de la bordure d'une surface
- Cache de profil de sol en option

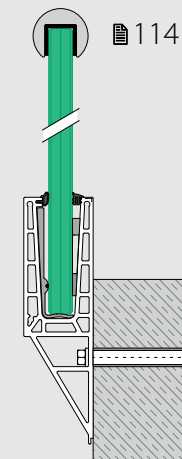

Profil de garde-corps

Safety Wedge System (set de cales en caoutchouc)

Pour une fixation ajustable du verre

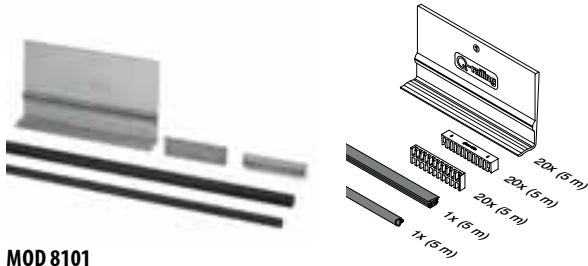

MOD 8101

Accessoires

Pour verre monolithique			T	
SELL OUT	208101-050-12	12	L = 5 m	
SELL OUT	208101-050-15	15	L = 5 m	
SELL OUT	208101-050-19	19	L = 5 m	

Pour verre feuilleté

SELL OUT	208101-050-13	12,76	L = 5 m
SELL OUT	208101-050-14	13,52	L = 5 m
SELL OUT	208101-050-17	16,76	L = 5 m
SELL OUT	208101-050-18	17,52	L = 5 m
SELL OUT	208101-050-21	20,76	L = 5 m
SELL OUT	208101-050-22	21,52	L = 5 m

International Design Modèle Protection

Accessoires

Outil multi-fonctions Easy Glass®



MOD 1001

Accessoires

Accessoires			Q	
201001	Q-71		Q-71	1

Q-INFO MOD 8101

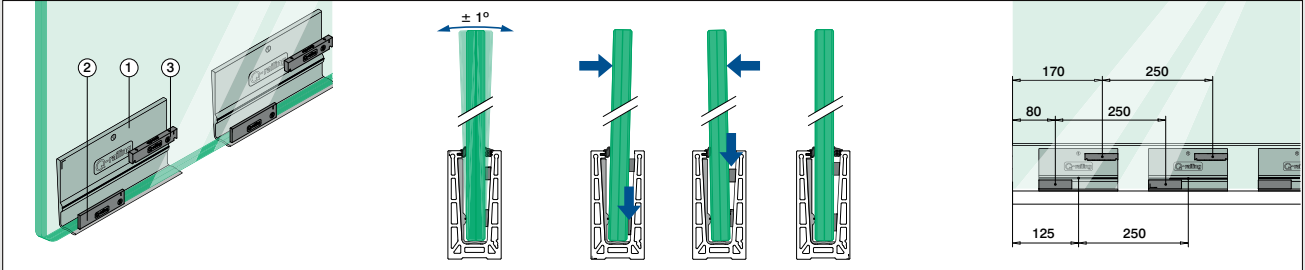

Profil de garde-corps

Safety Wedge System (set de cales en caoutchouc)

Pour une fixation du verre

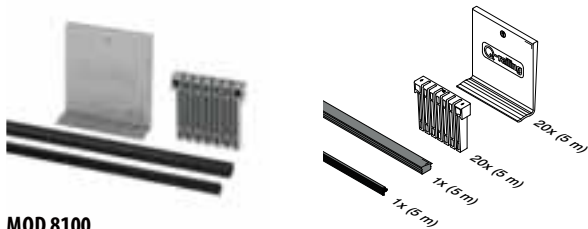

MOD 8100

Accessoires

Pour verre monolithique			T	
SELL OUT	208100-050-12	12	L = 5 m	
SELL OUT	208100-050-15	15	L = 5 m	
SELL OUT	208100-050-19	19	L = 5 m	

Pour verre feuilleté

SELL OUT	208100-050-13	12,76	L = 5 m
SELL OUT	208100-050-14	13,52	L = 5 m
SELL OUT	208100-050-17	16,76	L = 5 m
SELL OUT	208100-050-18	17,52	L = 5 m
SELL OUT	208100-050-21	20,76	L = 5 m
SELL OUT	208100-050-22	21,52	L = 5 m

International Design Modèle Protection

Accessoires

Outil multi-fonctions Easy Glass®



MOD 1001

Accessoires

Accessoires			Q	
201001	Q-71		Q-71	1

Q-INFO MOD 8100

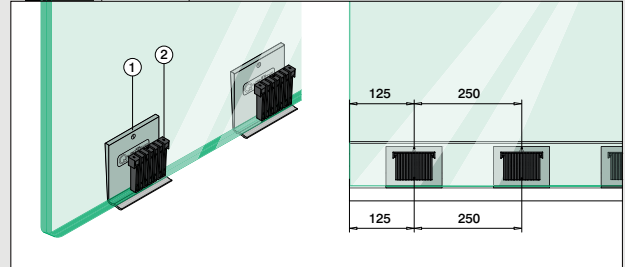

Safety Wedge System (set de cales en caoutchouc)

Pour une fixation ajustable du verre Easy Glass® Pro F

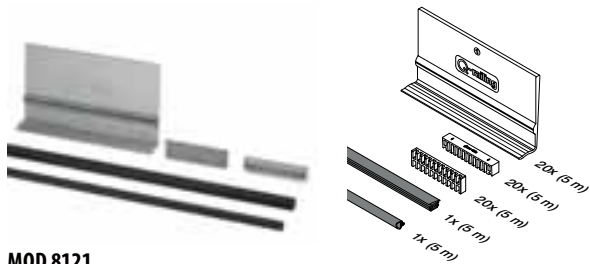

MOD 8121

Accessoires

Pour verre monolithique		T	
SELL OUT	208121-050-12	12	L = 5 m
SELL OUT	208121-050-15	15	L = 5 m
SELL OUT	208121-050-19	19	L = 5 m

Pour verre feuilleté

SELL OUT	208121-050-13	12,76	L = 5 m
SELL OUT	208121-050-14	13,52	L = 5 m
SELL OUT	208121-050-17	16,76	L = 5 m
SELL OUT	208121-050-18	17,52	L = 5 m
SELL OUT	208121-050-21	20,76	L = 5 m
SELL OUT	208121-050-22	21,52	L = 5 m

International Design Modèle Protection

Outil multi-fonctions Easy Glass®



MOD 1001

Accessoires

		Q	
201001		Q-71	1

Q-INFO MOD 8121

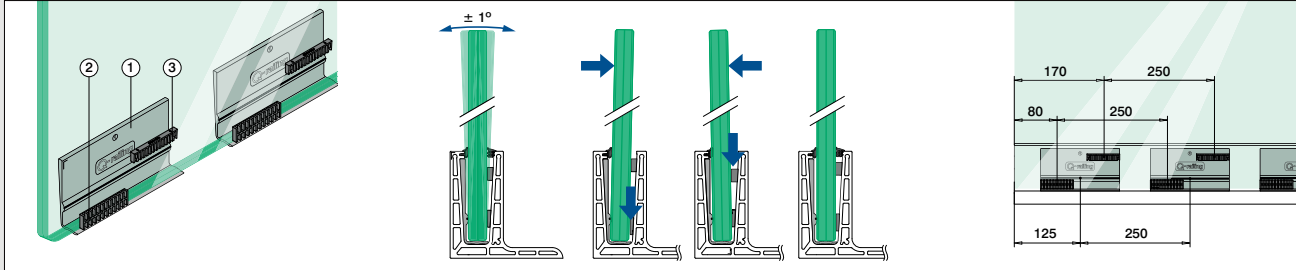

Goujons d'assemblage

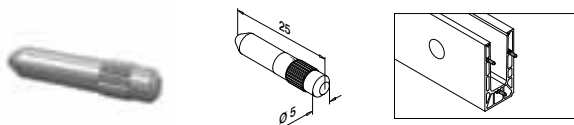

MOD 3005

316 Brut
OUTDOOR

143005		6
--------	--	---



SELL OUT Seulement jusqu'à épuisement des stocks.

Joint de remplissage

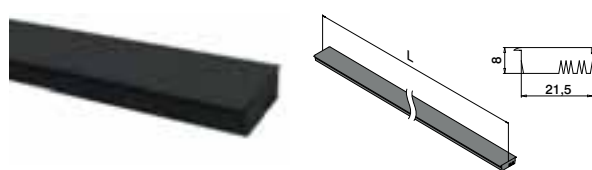

MOD 8105

Accessoires

SELL OUT	208105-025		L = 2,5 m
----------	------------	--	-----------



Q-INFO MOD 1001

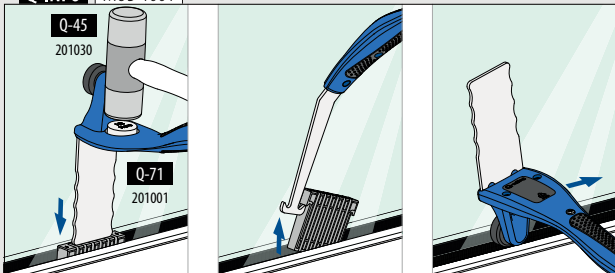

Q-INFO MOD 8105

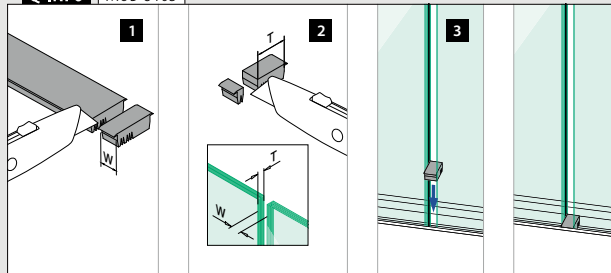

Profil de garde-corps

Profil de sol, montage au sol

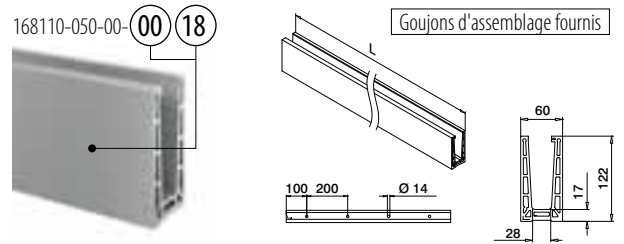
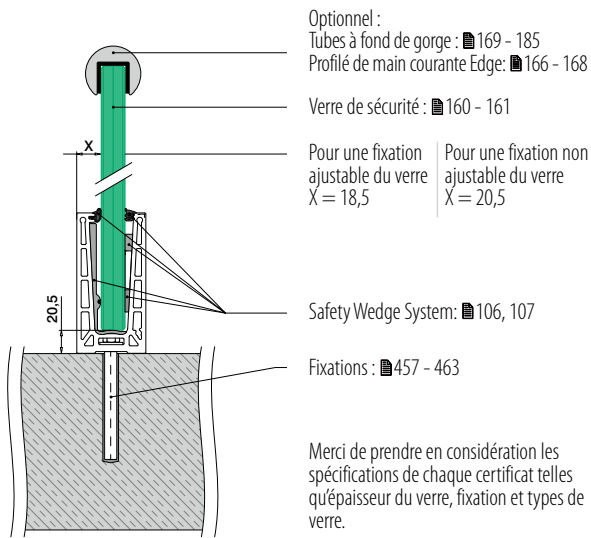

MOD 8110

Aluminium Brut

SELL OUT	168110-050-00-00	457 - 463	L = 5 m
----------	------------------	-----------	---------

Aluminium Brossé, anodisé

OUTDOOR

SELL OUT	168110-050-00-18	457 - 463	L = 5 m
----------	------------------	-----------	---------



International Design
Modèle Protection

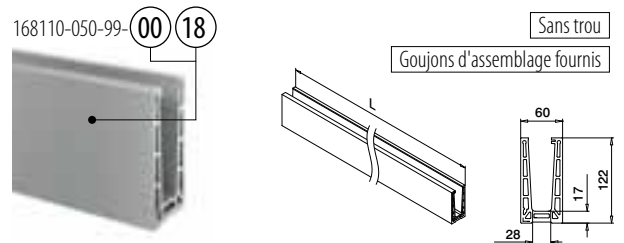

MOD 8110

Aluminium Brut

SELL OUT	168110-050-99-00		L = 5 m
----------	------------------	--	---------

Aluminium Brossé, anodisé

OUTDOOR

SELL OUT	168110-050-99-18		L = 5 m
----------	------------------	--	---------



International Design
Modèle Protection

Seulement jusqu'à épuisement des stocks.

Q-INFO

PREFIX

Q-INFO

MOD 8105
107

Joint de remplissage

Q-INFO **Aluminium**

00 Brut 18 Brossé, anodisé

Q-INFO

MOD 3005
107

Autres goujons d'assemblage

Angles, montage au sol

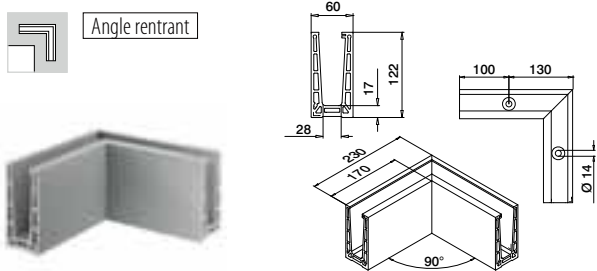

MOD 8111

Aluminium Brossé, anodisé

OUTDOOR

SELL OUT	168111-01-18	457 - 463	1
----------	--------------	-----------	---

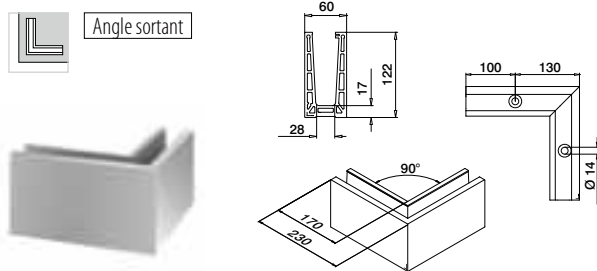

MOD 8111

Aluminium Brossé, anodisé

OUTDOOR

SELL OUT	168111-02-18	457 - 463	1
----------	--------------	-----------	---



Embouts, montage au sol

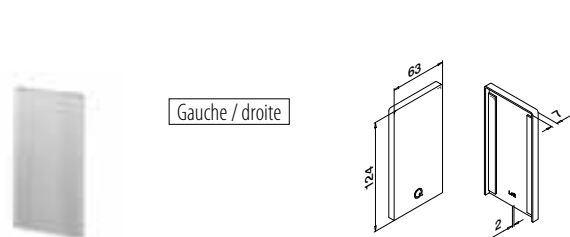

MOD 8112

Aluminium Brut

Ruban adhésif

SELL OUT	168112-00-00	Fourni	1
----------	--------------	--------	---

Aluminium Brossé, anodisé

OUTDOOR

SELL OUT	168112-00-18	Pré-collé	1
----------	--------------	-----------	---

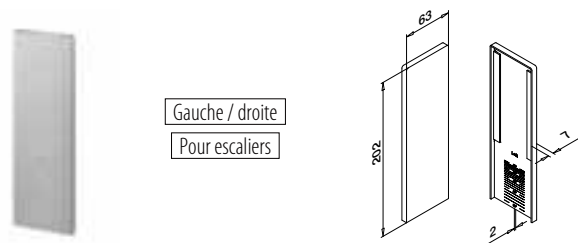

MOD 8113

Aluminium Brossé, anodisé

OUTDOOR

Ruban adhésif

SELL OUT	168113-00-18	Pré-collé	1
----------	--------------	-----------	---



Profils de drainage, montage au sol

8 pièces pour un profilé de sol de 5 mètres

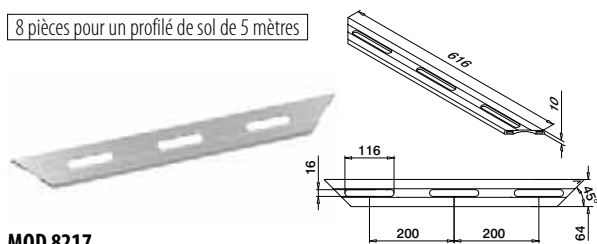

MOD 8217

Aluminium Brossé, anodisé

OUTDOOR

SELL OUT	168217-18		4
----------	-----------	--	---

Q-INFO MOD 8217

Informations sur l'assemblage :

<https://q-ne.ws/Pro23>

Q-INFO MOD 8112

Q-INFO MOD 8113

L+R	30°	35°	40°	45°	50°
-----	-----	-----	-----	-----	-----

Profil de garde-corps

Profil de sol, montage au sol

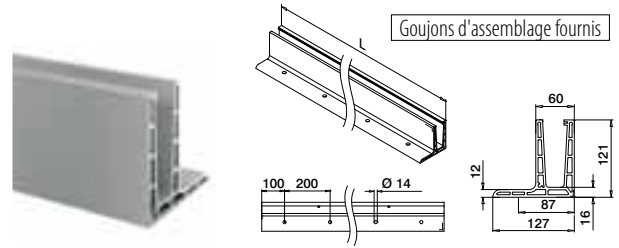
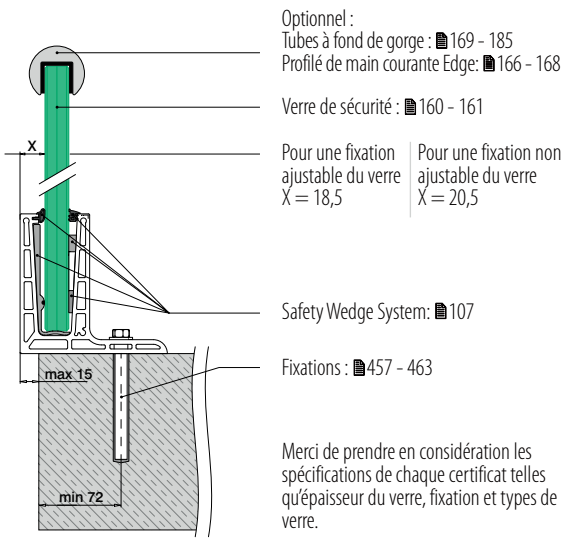

MOD 8120

Aluminium Brossé, anodisé

OUTDOOR

SELL OUT 168120-050-00-18 █ 457 - 463 L = 5 m



International Design
Modèle Protection

Profil de garde-corps

Angles, montage au sol

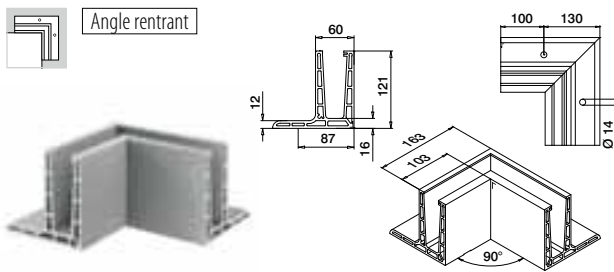

MOD 8121

Aluminium Brossé, anodisé

OUTDOOR

SELL OUT 168121-01-18 █ 457 - 463 1

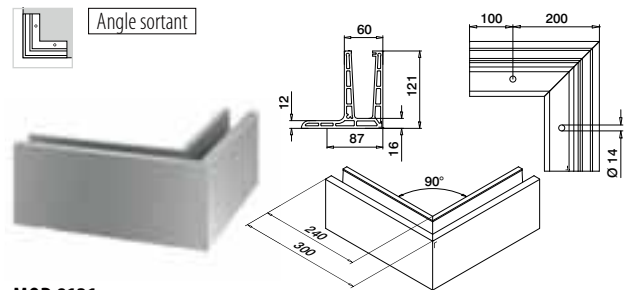

MOD 8121

Aluminium Brossé, anodisé

OUTDOOR

SELL OUT 168121-02-18 █ 457 - 463 1



Profil de garde-corps

Embouts, montage au sol

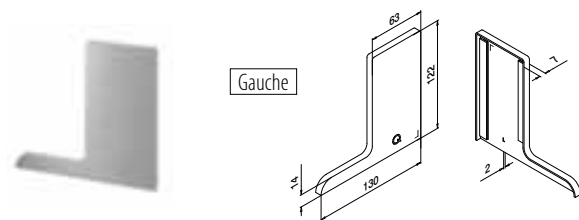

MOD 8122

Aluminium Brossé, anodisé

OUTDOOR

Ruban adhésif



SELL OUT 168122-01-18 Pré-collé 1



Seulement jusqu'à épuisement des stocks.

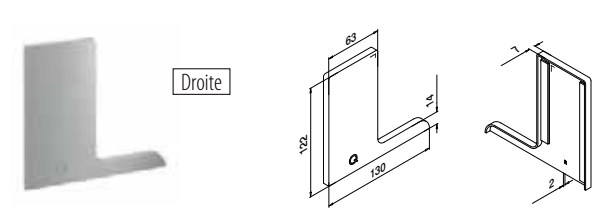

MOD 8122

Aluminium Brossé, anodisé

OUTDOOR

Ruban adhésif



SELL OUT 168122-02-18 Pré-collé 1

Q-INFO MOD 8120

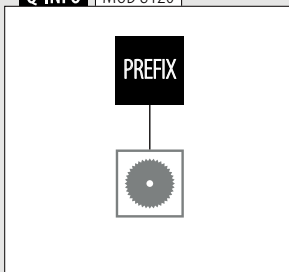

Q-INFO MOD 8120

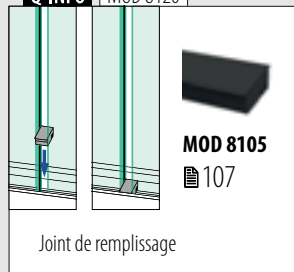

Q-INFO MOD 8122

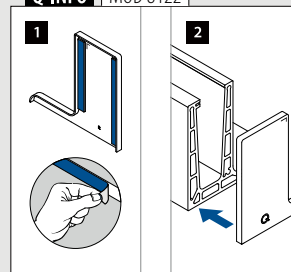

Q-INFO MOD 8120 / 8121

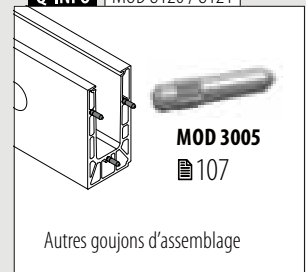



Profil de garde-corps

Profil de sol, montage latéral

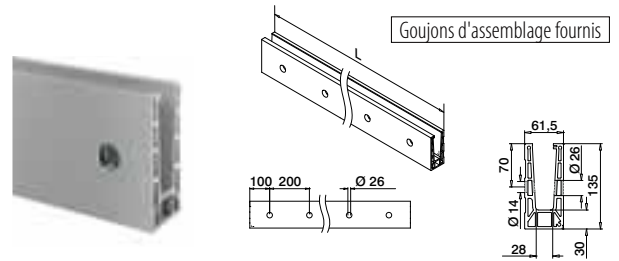
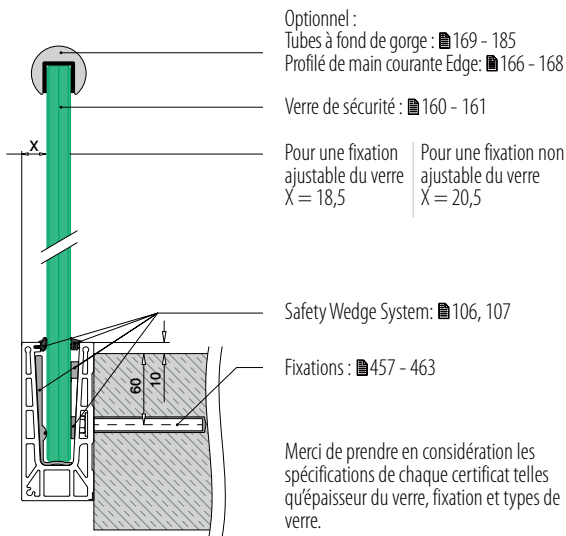

MOD 8130

Aluminium Brossé, anodisé

OUTDOOR

SELL OUT 168130-050-00-18 457 - 463 L = 5 m



International Design
Modèle Protection

Profil de garde-corps

Angles, montage latéral

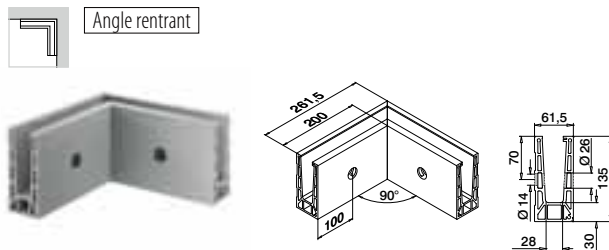

MOD 8131

Aluminium Brossé, anodisé

OUTDOOR

SELL OUT 168131-01-18 457 - 463 1

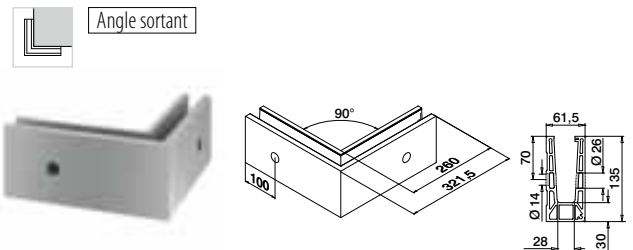

MOD 8131

Aluminium Brossé, anodisé

OUTDOOR

SELL OUT 168131-02-18 457 - 463 1

Profil de garde-corps

Profils de drainage, montage latéral

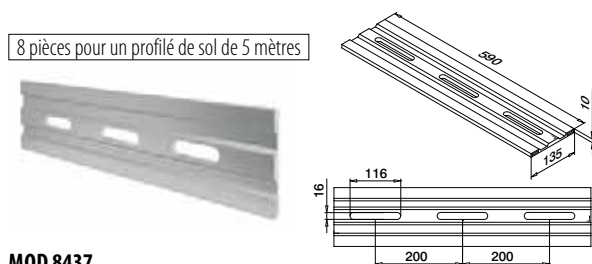

MOD 8437

Aluminium Brossé, anodisé

OUTDOOR

SELL OUT 168437-18 4

Q-INFO MOD 8130 / 8131

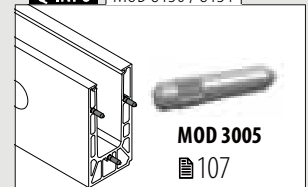

Autres goujons d'assemblage

Q-INFO MOD 8130

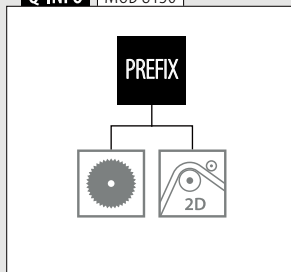

Q-INFO MOD 8130

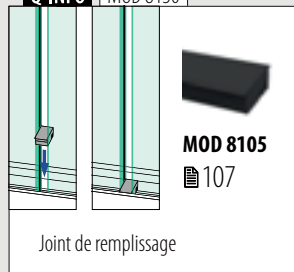

Q-INFO MOD 8437

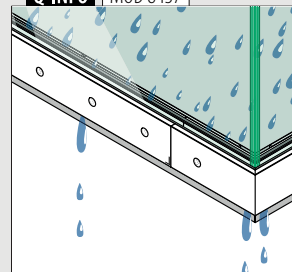

Informations sur l'assemblage :



<https://q-ne.ws/Pro23>

Profil de garde-corps

Embouts, montage latéral

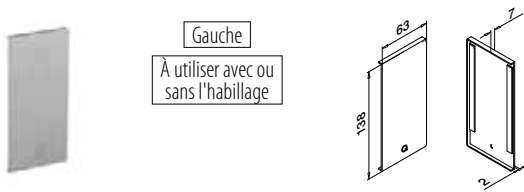

Gauche
À utiliser avec ou sans l'habillage

MOD 8132

Aluminium	Brossé, anodisé	
OUTDOOR	Ruban adhésif	
SELL OUT 168132-01-18	Pré-collé	1

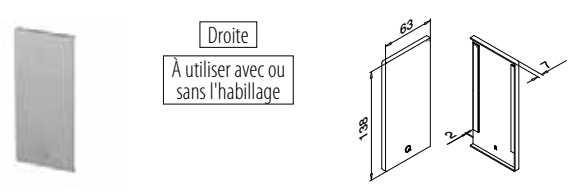

Droite
À utiliser avec ou sans l'habillage

MOD 8132

Aluminium	Brossé, anodisé	
OUTDOOR	Ruban adhésif	
SELL OUT 168132-02-18	Pré-collé	1

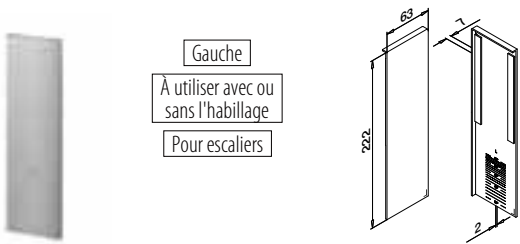

Gauche
À utiliser avec ou sans l'habillage
Pour escaliers

MOD 8133

Aluminium	Brossé, anodisé	
OUTDOOR	Ruban adhésif	
SELL OUT 168133-01-18	Pré-collé	1

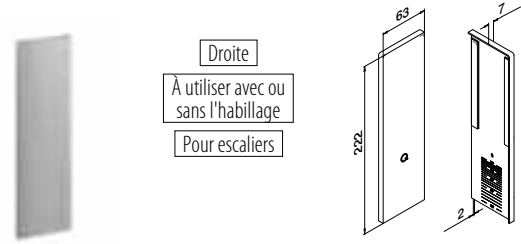

Droite
À utiliser avec ou sans l'habillage
Pour escaliers

MOD 8133

Aluminium	Brossé, anodisé	
OUTDOOR	Ruban adhésif	
SELL OUT 168133-02-18	Pré-collé	1



Profil de garde-corps

Habillage, montage latéral



Habillage avant

MOD 8135

Aluminium	Brossé, anodisé	
OUTDOOR	Ruban adhésif	
SELL OUT 168135-050-18	Pré-collé	L = 5 m



Profil de garde-corps

Embouts, montage latéral

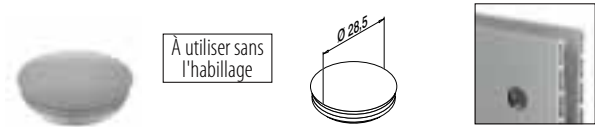

À utiliser sans l'habillage

MOD 8138

Plastique	Aluminium blanc RAL 9006	
INDOOR		
SELL OUT 158138-36		10

Q-INFO MOD 8135

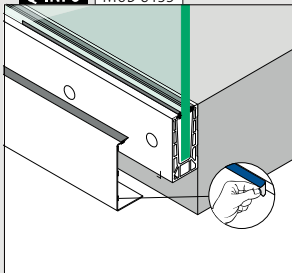

Q-INFO MOD 8138

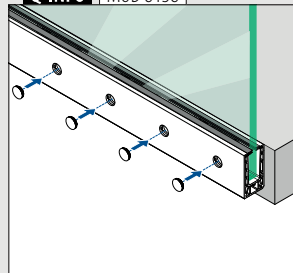

Q-INFO MOD 8132

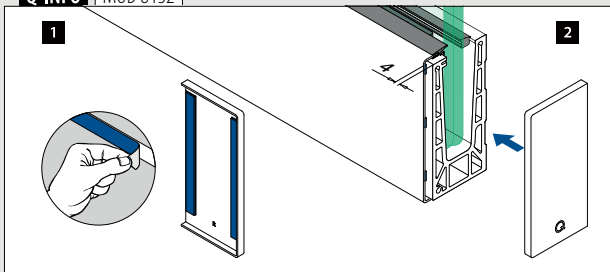

Q-INFO MOD 8133

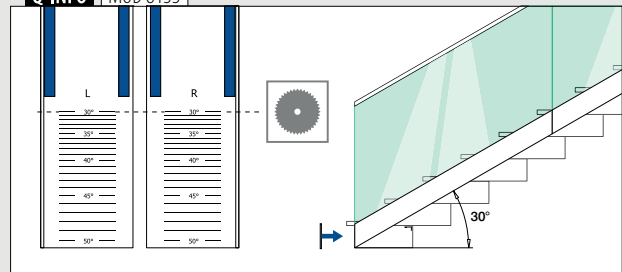

SELL OUT Seulement jusqu'à épuisement des stocks.

Profil de garde-corps

Profil de sol, montage latéral

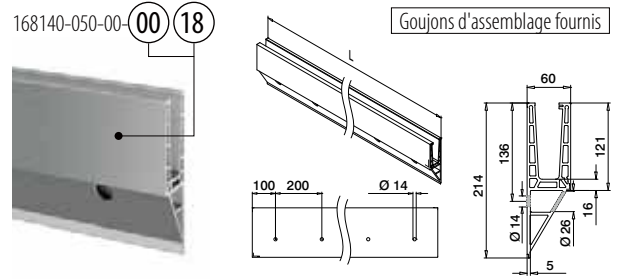
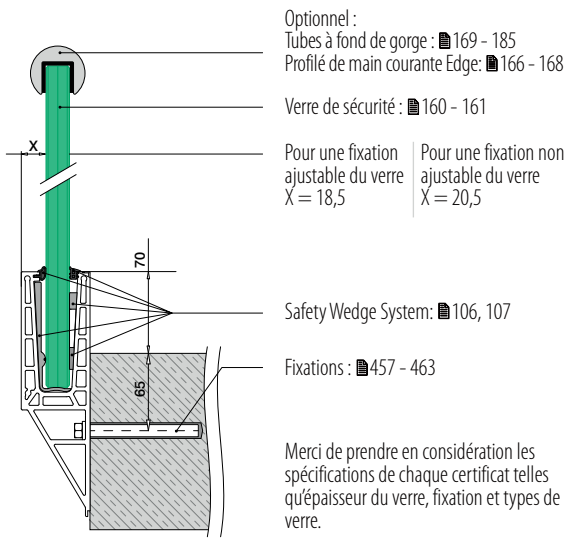

MOD 8140

Aluminium Brut

SELL OUT 168140-050-00-00 ■ 457 - 463 L = 5 m

Aluminium Brossé, anodisé

OUTDOOR

SELL OUT 168140-050-00-18 ■ 457 - 463 L = 5 m



International Design
Modèle Protection

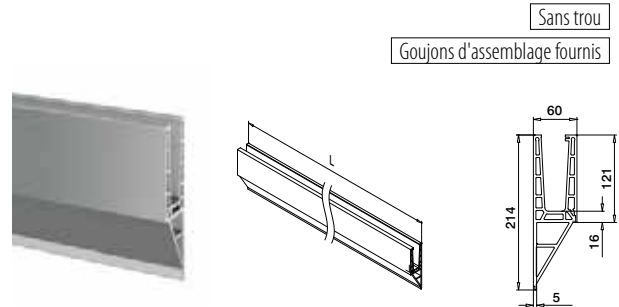

MOD 8140

Aluminium Brossé, anodisé

OUTDOOR

SELL OUT 168140-050-99-18 L = 5 m



International Design
Modèle Protection

SELL OUT Seulement jusqu'à épuisement des stocks.

Q-INFO

PREFIX

Q-INFO

MOD 8105
■ 107

Joint de remplissage

Q-INFO **Aluminium**

00 18

Brut Brossé, anodisé

Q-INFO

MOD 3005
■ 107

Autres goujons d'assemblage

Profil de garde-corps

Angles, montage latéral

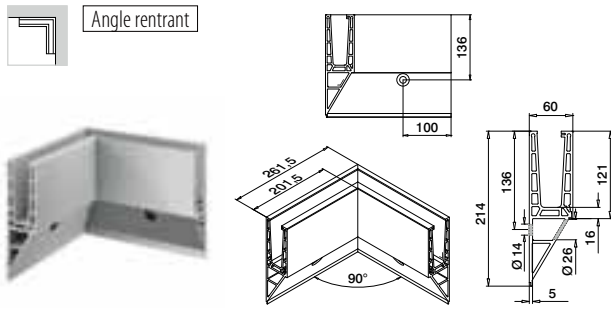

MOD 8141

Aluminium Brosse, anodisé
OUTDOOR

SELL OUT	168141-01-18	457 - 463	1
----------	--------------	-----------	---

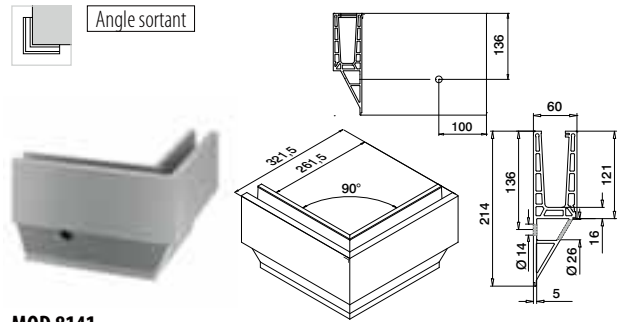

MOD 8141

Aluminium Brosse, anodisé
OUTDOOR

SELL OUT	168141-02-18	457 - 463	1
----------	--------------	-----------	---



Profil de garde-corps

Embouts, montage latéral

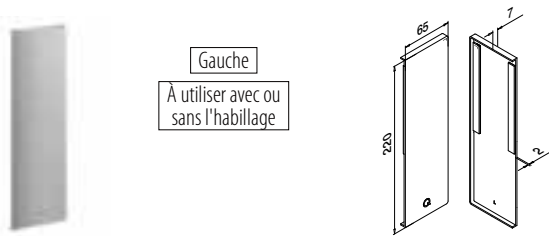

MOD 8142

Aluminium Brosse, anodisé
OUTDOOR Ruban adhésif

SELL OUT	168142-01-18	Pré-collé	1
----------	--------------	-----------	---

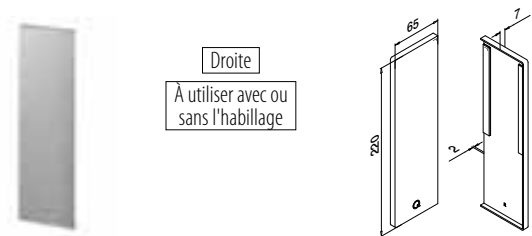

MOD 8142

Aluminium Brosse, anodisé
OUTDOOR Ruban adhésif

SELL OUT	168142-02-18	Pré-collé	1
----------	--------------	-----------	---

Profil de garde-corps

Habillage, montage latéral



MOD 8145

Aluminium Brosse, anodisé
OUTDOOR Ruban adhésif

SELL OUT	168145-050-18	Pré-collé	L = 5 m
----------	---------------	-----------	---------



Q-INFO MOD 8142

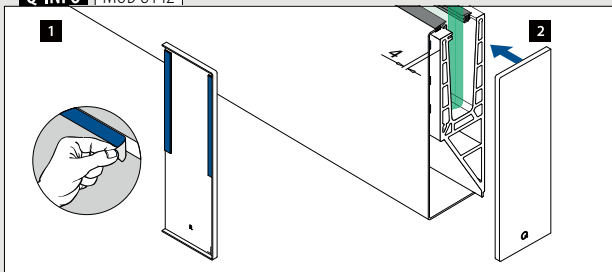

Q-INFO MOD 8145

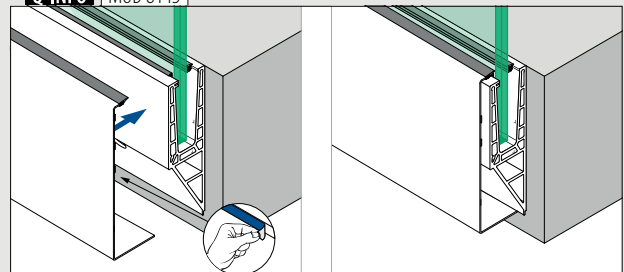



- Conçu pour :** Utilisation pour des contraintes élevées
- Utilisation :** Intérieur et extérieur
- Variantes :** Montage au sol, latéral et engravé
- Applications :** Balcons, galeries, passerelles, cloisons, escaliers et pare-vents
- Matériau :** Aluminium (brossé anodisé et brut)
- Épaisseur de verre :** 19 à 31,52 mm

Retrouvez toutes les informations sur Easy Glass Max en ligne :



<https://q-ne.ws/Max23>

EASY GLASS[®] MAX

La robustesse et la sécurité sans compromis



Cet élégant système supporte aisément des charges extrêmement lourdes et des vents violents. Avec autant d'atouts, Max est idéal pour les grandes infrastructures publiques comme les stades, les aéroports et les centres commerciaux.

Easy Glass® Max	BE
Max. charge linéaire (kN/m)	3,0

Merci de prendre en considération les spécifications de chaque certificat telles qu'épaisseur du verre, fixation.

Tests/calculs/certificats internationaux:



- 1 Idéal pour les grandes infrastructures publiques comme les stades.
- 2 S'installe directement sur du béton, sans structure métallique.



DÉCLINAISONS D'EASY GLASS® MAX

Max Montage au sol

- Également pour scellement au sol

Max F Montage au sol

- Pour les sols bruts
- Peut aussi s'installer sur ou au-dessus de la bordure d'une surface

Max Montage latéral

- Habillages disponibles

Max Y Montage latéral

- Pour les sols bruts
- Peut aussi s'installer sur ou au-dessus de la bordure d'une surface
- Cache de profil de sol en option

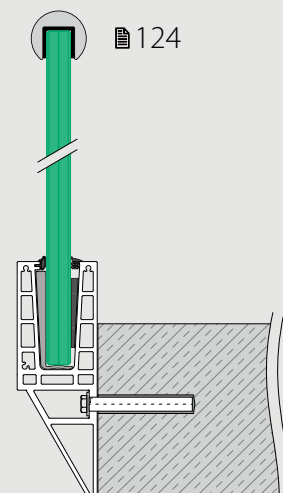
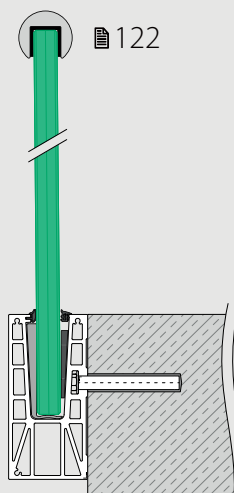
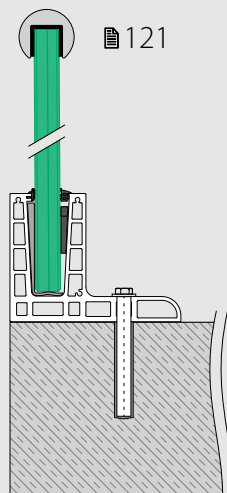
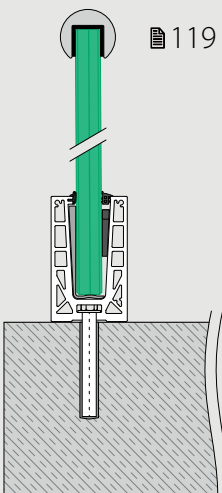

Profil de garde-corps

Safety Wedge System (set de cales en caoutchouc)

Pour une fixation du verre

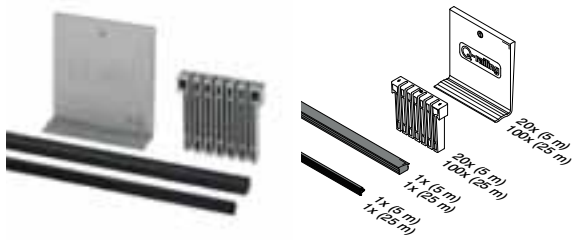

MOD 8500

Accessoires		
Pour verre monolithique	T	
208500-050-19	19	L = 5 m
208500-050-25	25	L = 5 m
<hr/>		
208500-250-19	19	L = 25 m
<hr/>		
Pour verre feuilleté		
208500-050-21	20,76	L = 5 m
208500-050-22	21,52	L = 5 m
208500-050-24	24,76	L = 5 m
208500-050-26	25,52	L = 5 m
208500-050-32	31,52	L = 5 m
<hr/>		
208500-250-21	20,76	L = 25 m
208500-250-22	21,52	L = 25 m
208500-250-24	24,76	L = 25 m
208500-250-26	25,52	L = 25 m
208500-250-32	31,52	L = 25 m

International Design Modèle Protection

Accessoires

Outil multi-fonctions Easy Glass®



MOD 1001

Accessoires		
	Q	
201001	Q-71	1

Accessoires

Joint de bourrage seuls



MOD 8506

Accessoires		
208506-250-00	L = 25 m	

NEW



MOD 8506

Accessoires		
Pour verre monolithique	T	
208506-250-19	19	L = 25 m

Pour verre feuilleté

208506-250-22	20,76 - 21,52	L = 25 m
208506-250-26	24,76 - 25,52	L = 25 m
208506-250-32	31,52	L = 25 m

NEW

Profil de garde-corps

Joint de remplissage

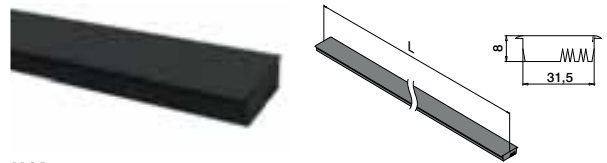

MOD 8505

Accessoires		
208505-025	L = 2,5 m	



Q-INFO MOD 8500

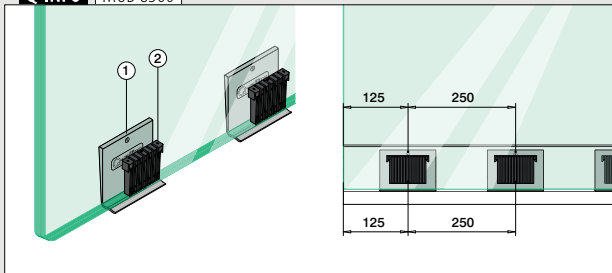

Q-INFO MOD 1001

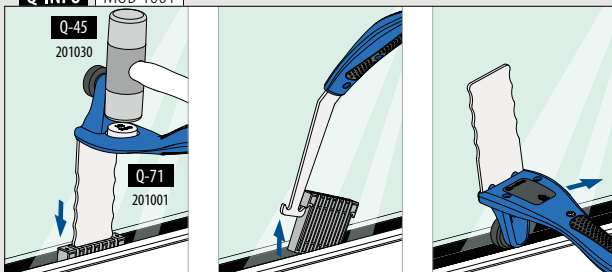

Q-INFO MOD 8505

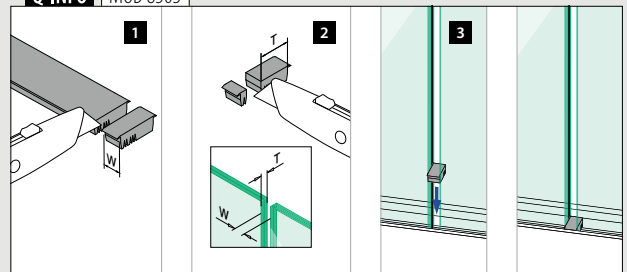

Profil de sol, montage au sol

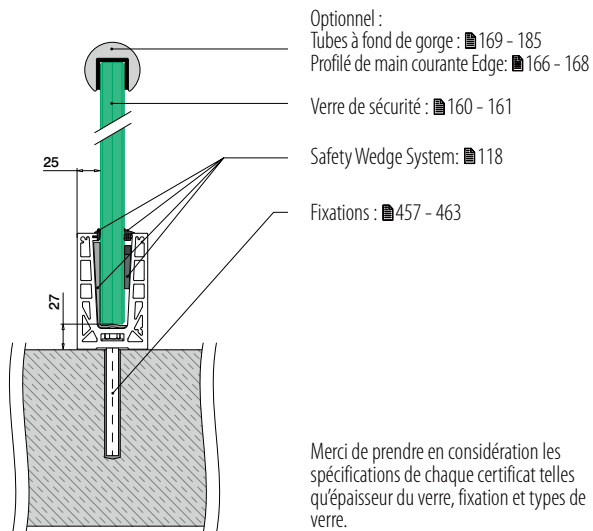

- Optionnel :
Tubes à fond de gorge : █ 169 - 185
Profilé de main courante Edge: █ 166 - 168
- Verre de sécurité : █ 160 - 161
- Safety Wedge System: █ 118
- Fixations : █ 457 - 463

Merci de prendre en considération les spécifications de chaque certificat telles qu'épaisseur du verre, fixation et types de verre.

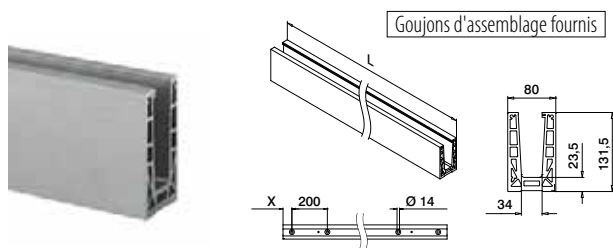

MOD 8510

Aluminium Brut

	X	Fixation	Accessoire
NEW 168510-025-00-00	50	█ 457 - 463	L = 2,5 m
NEW 168510-050-00-00	100	█ 457 - 463	L = 5 m

Aluminium Brossé, anodisé

OUTDOOR			
168510-025-00-18	50	█ 457 - 463	L = 2,5 m
NEW 168510-050-00-18	100	█ 457 - 463	L = 5 m



International Design
Modèle Protection

Angles, montage au sol

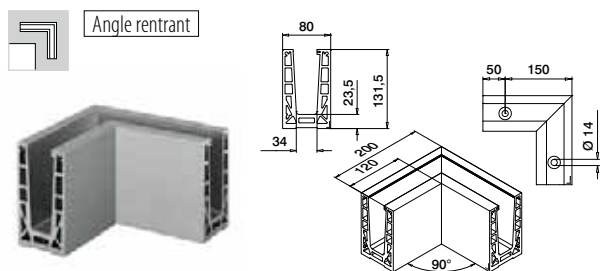

MOD 8511

Aluminium Brossé, anodisé

OUTDOOR

168511-01-18	█ 457 - 463	1
--------------	-------------	---

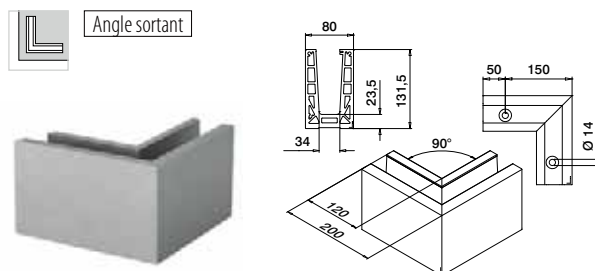

MOD 8511

Aluminium Brossé, anodisé

OUTDOOR

168511-02-18	█ 457 - 463	1
--------------	-------------	---



Goujons d'assemblage

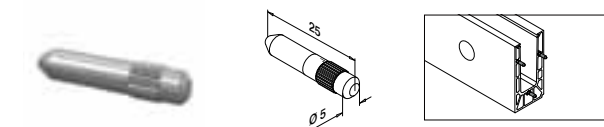

MOD 3005

316 Brut

OUTDOOR

143005	6
--------	---



Q-INFO MOD 8510

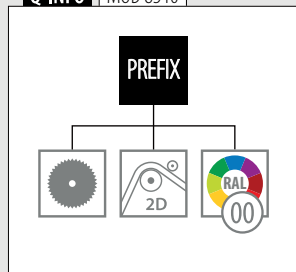

Q-INFO MOD 8510

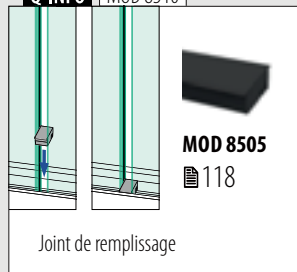

Q-INFO Aluminium

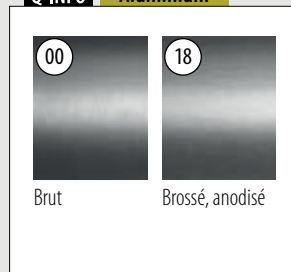

Profil de garde-corps

Embouts, montage au sol

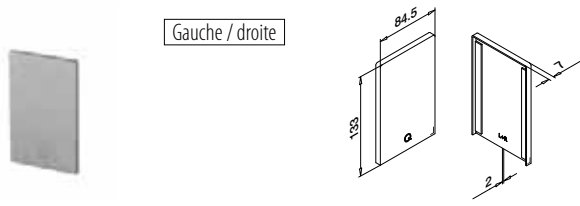

MOD 8512

Aluminium	Brossé, anodisé		
OUTDOOR	Ruban adhésif		
168512-00-18	Pré-collé	1	

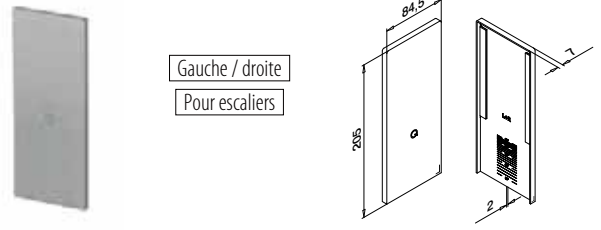

MOD 8513

Aluminium	Brossé, anodisé		
OUTDOOR	Ruban adhésif		
168513-00-18	Pré-collé	1	



Profil de garde-corps

Cale, montage au sol

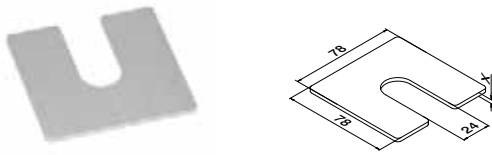

MOD 8516

Aluminium	Brut		
	X		
168516-001	1	100	
168516-002	2	100	
168516-003	3	100	

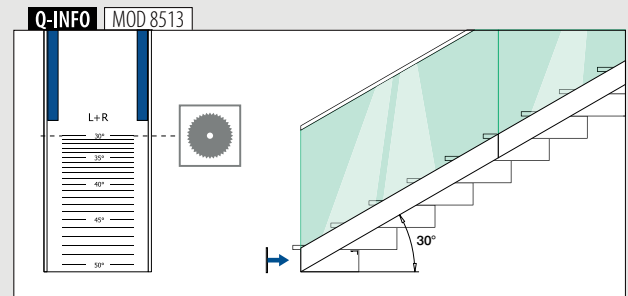
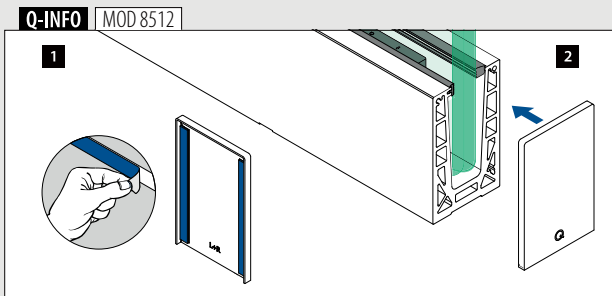
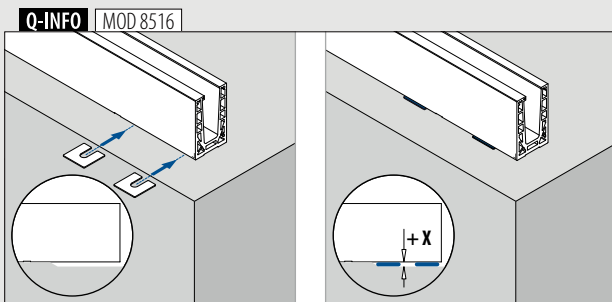

Profil de sol, montage au sol

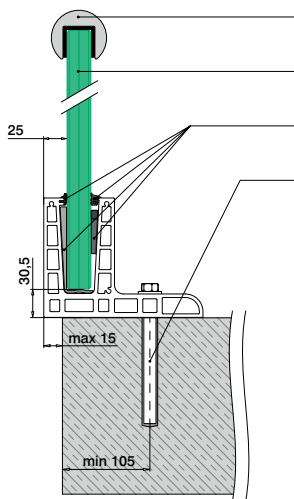

- Optionnel :
Tubes à fond de gorge : █ 169 - 185
Profilé de main courante Edge: █ 166 - 168
- Verre de sécurité : █ 160 - 161
- Safety Wedge System : █ 118
- Fixations : █ 457 - 463

Merci de prendre en considération les spécifications de chaque certificat telles qu'épaisseur du verre, fixation et types de verre.

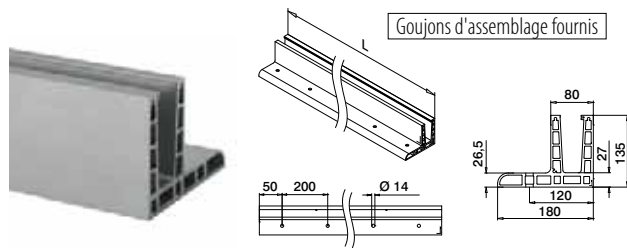

MOD 8520

Aluminium Brossé, anodisé

OUTDOOR

168520-025-00-18 █ 457 - 463 L = 2,5 m



International Design
Modèle Protection

Angles, montage au sol

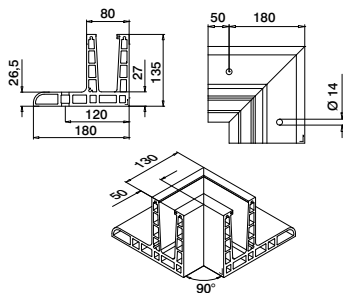

MOD 8521

Aluminium Brossé, anodisé

OUTDOOR

168521-01-18 █ 457 - 463 1

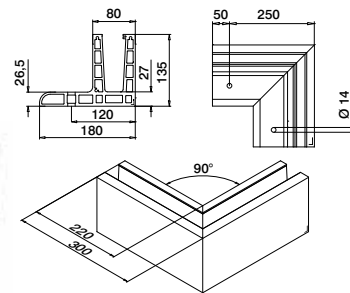

MOD 8521

Aluminium Brossé, anodisé

OUTDOOR

168521-02-18 █ 457 - 463 1



Embouts, montage au sol

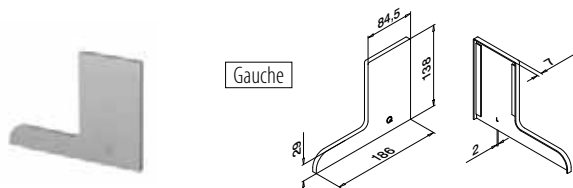

MOD 8522

Aluminium Brossé, anodisé

OUTDOOR

Ruban adhésif

168522-01-18 Pré-collé 1

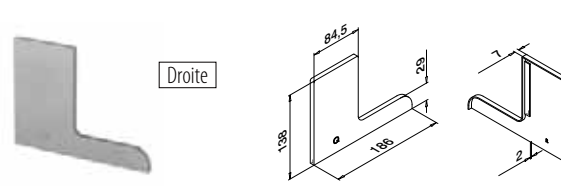

MOD 8522

Aluminium Brossé, anodisé

OUTDOOR

Ruban adhésif

168522-02-18 Pré-collé 1

Q-INFO MOD 8520

PREFIX

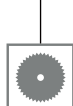

Q-INFO MOD 8520

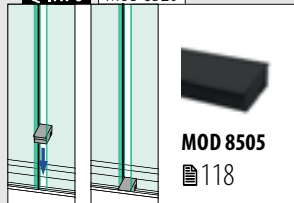

Joint de remplissage

Q-INFO MOD 8522

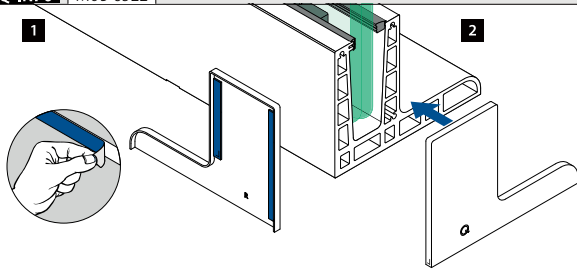

Profil de garde-corps

Profil de sol, montage latéral

Optionnel :
Tubes à fond de gorge : 169 - 185
Profilé de main courante Edge: 166 - 168

Verre de sécurité : 160 - 161

Safety Wedge System: 118

Fixations : 457 - 463

max 10
min 60

Merci de prendre en considération les spécifications de chaque certificat telles qu'épaisseur du verre, fixation et types de verre.

Goujons d'assemblage fournis

MOD 8530

Aluminium Brosse, anodisé

OUTDOOR

168530-025-00-18

457 - 463

L = 2,5 m



International Design
Modèle Protection

Profil de garde-corps

Angles, montage latéral

Angle rentrant

MOD 8531

Aluminium Brosse, anodisé

OUTDOOR

168531-01-18

457 - 463

1



Angle sortant

MOD 8531

Aluminium Brosse, anodisé

OUTDOOR

168531-02-18

457 - 463

1



Q-INFO MOD 8530

PREFIX

Q-INFO MOD 8530

MOD 8505
118

Joint de remplissage

Embout, montage latéral



Gauche

MOD 8532

Aluminium	Brossé, anodisé		
OUTDOOR	Ruban adhésif		
168532-01-18	Pré-collé		1

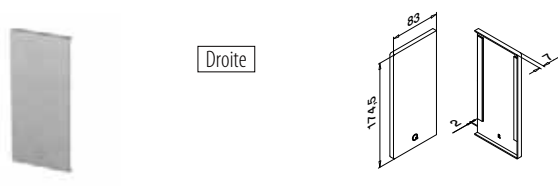

Droite

MOD 8532

Aluminium	Brossé, anodisé		
OUTDOOR	Ruban adhésif		
168532-02-18	Pré-collé		1

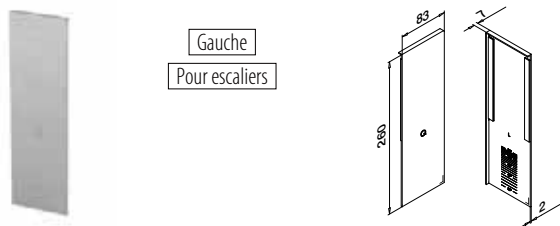

Gauche
Pour escaliers

MOD 8533

Aluminium	Brossé, anodisé		
OUTDOOR	Ruban adhésif		
168533-01-18	Pré-collé		1

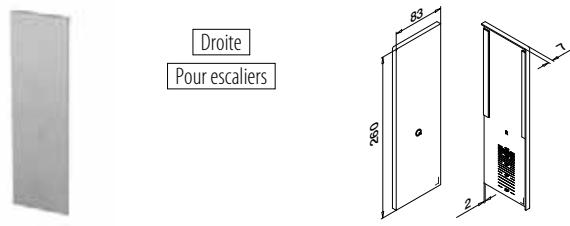

Droite
Pour escaliers

MOD 8533

Aluminium	Brossé, anodisé		
OUTDOOR	Ruban adhésif		
168533-02-18	Pré-collé		1



Habillage, montage latéral

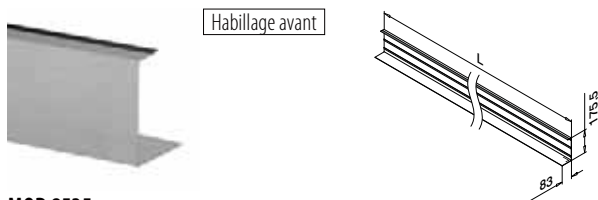

Habillage avant

MOD 8535

Aluminium	Brossé, anodisé		
OUTDOOR	Ruban adhésif		
168535-050-18	Pré-collé		L = 5 m



Embout, montage latéral

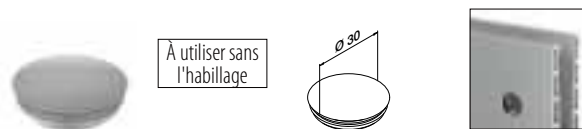

À utiliser sans l'habillage

MOD 8538

Plastique	Aluminium blanc RAL 9006		
INDOOR			
158538-36			10

Q-INFO MOD 8532 / 8533

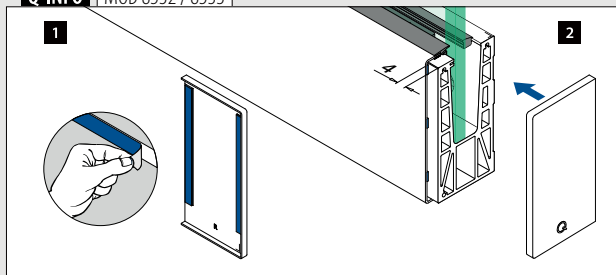

Q-INFO MOD 8533

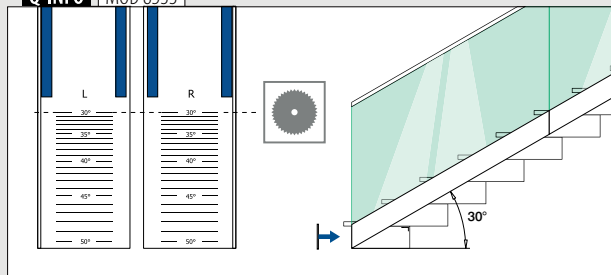

Q-INFO MOD 8535

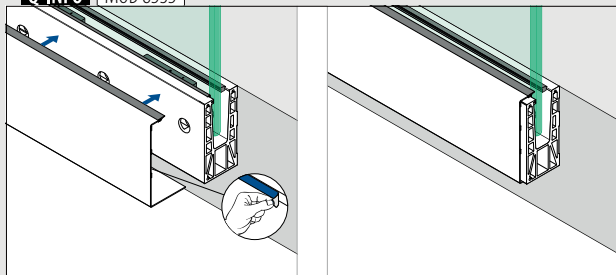

Q-INFO MOD 8538

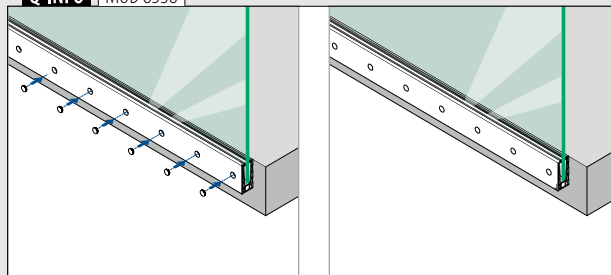

Profil de garde-corps

Profil de sol, montage latéral

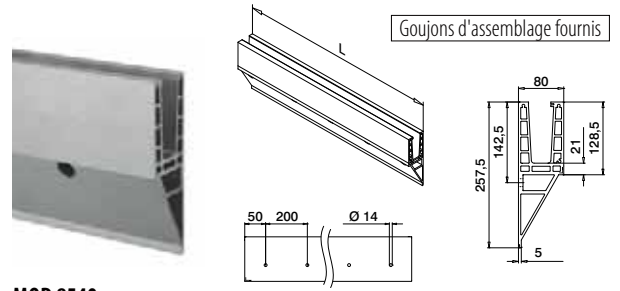
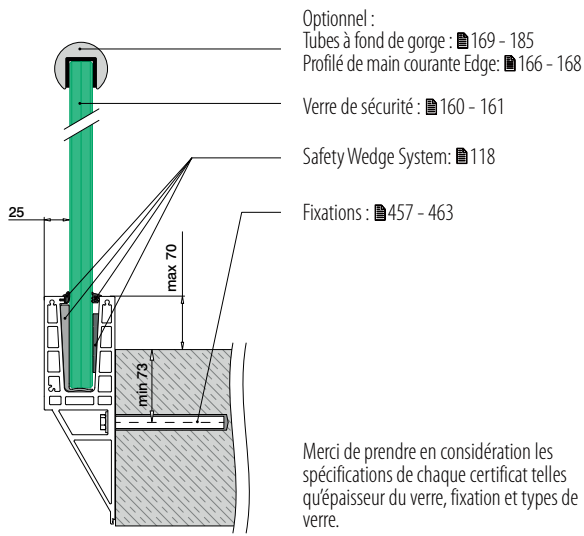

MOD 8540

Aluminium Brosse, anodisé
OUTDOOR

168540-025-00-18 457 - 463 L = 2,5 m



International Design
Modèle Protection

Profil de garde-corps

Angles, montage latéral

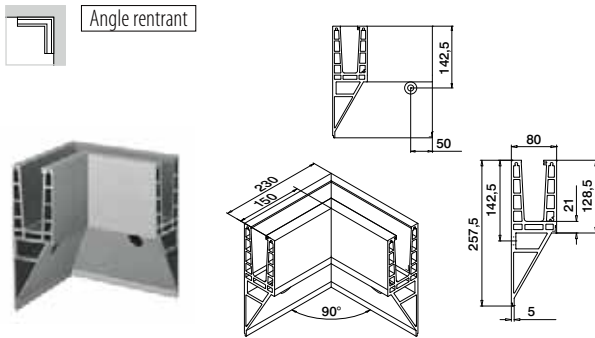

MOD 8541

Aluminium Brosse, anodisé
OUTDOOR

168541-01-18 457 - 463 1

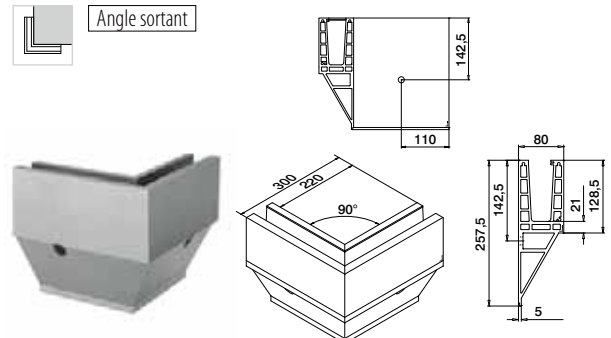

MOD 8541

Aluminium Brosse, anodisé
OUTDOOR

168541-02-18 457 - 463 1



Q-INFO MOD 8540

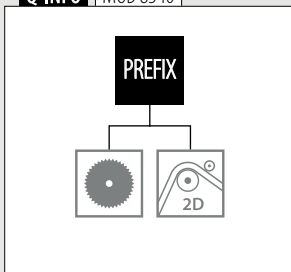

Q-INFO MOD 8540

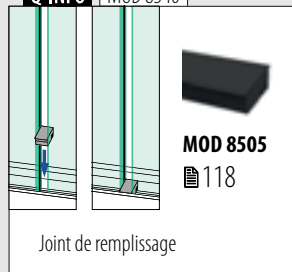

Embouts, montage latéral



Gauche

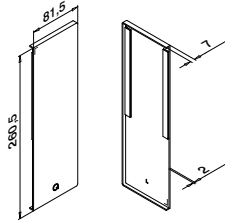

MOD 8542

Aluminium	Brossé, anodisé		
OUTDOOR	Ruban adhésif		
168542-01-18	Pré-collé	1	



Droite

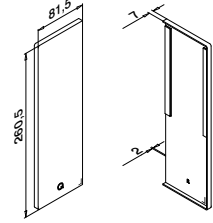

MOD 8542

Aluminium	Brossé, anodisé		
OUTDOOR	Ruban adhésif		
168542-02-18	Pré-collé	1	

Habillage, montage latéral



Habillage avant

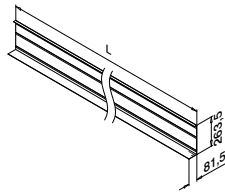

MOD 8545

Aluminium	Brossé, anodisé		
OUTDOOR	Ruban adhésif		
168545-050-18	Pré-collé	L = 5 m	



Q-INFO MOD 8542

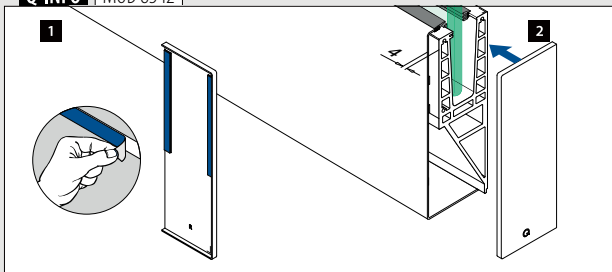

Q-INFO MOD 8545

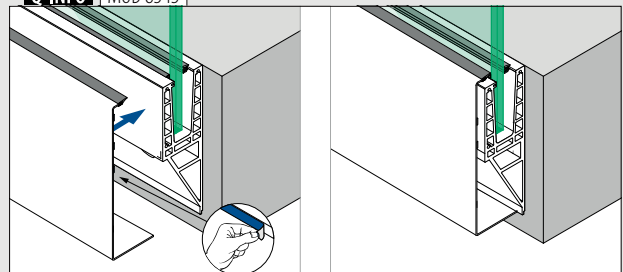



Conçu pour : Utilisation faible à moyenne
Utilisation : Intérieur et extérieur
Variantes : Montage au sol, latéral et engravé
Applications : Balcons, galeries et terrasses sur le toit
Matériau : Aluminium (brut ou brossé, anodisé)
Épaisseur de verre : 12 à 17,52 mm, hauteur max. 700 mm

Retrouvez toutes les informations sur Easy Glass Up en ligne :



<https://q-ne.ws/Up23>

EASY GLASS[®] UP

Une vue dégagée pour les espaces délimités par des murets

Easy Glass® Up est la solution ultime pour les surfaces délimitées par des parapets. Ses profils de sol ultra fins autorisent un montage au sol ou latéral vous assurant une vue dégagée. Vous pouvez utiliser ce système pour créer un garde-corps de balcon avec des remplissages en verre d'une hauteur maximale de de verre de 700 mm (soit 718,50 mm depuis le sol fini). Difficile de faire mieux pour votre toit-terrasse.

Easy Glass® Up	BE
Max. charge linéaire (kN/m)	1,0

Merci de prendre en considération les spécifications de chaque certificat telles qu'épaisseur du verre, fixation.

Tests/calculs/certificats internationaux:



- 1 Avec un profil de sol de seulement 80 mm, Easy Glass Up vous assure des vues dégagées depuis un balcon ou un toit-terrasse avec des parapets.
- 2 Vous pouvez le monter facilement depuis le balcon ou le toit.



DÉCLINAISONS D'EASY GLASS® UP

Up Montage au sol

- Pour les acrotères
- Également pour scellement au sol

130

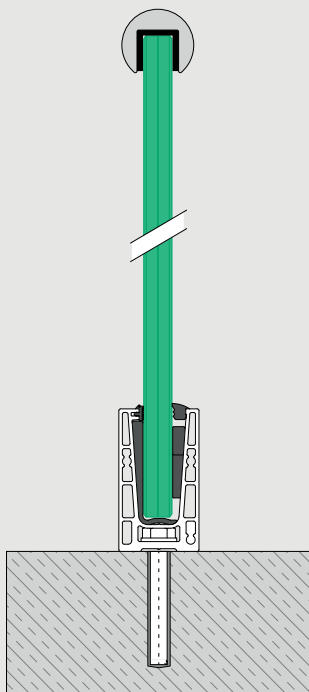

Up Montage latéral

- Pour les acrotères (fixation inversée)
- Cache de profil de sol en option

131

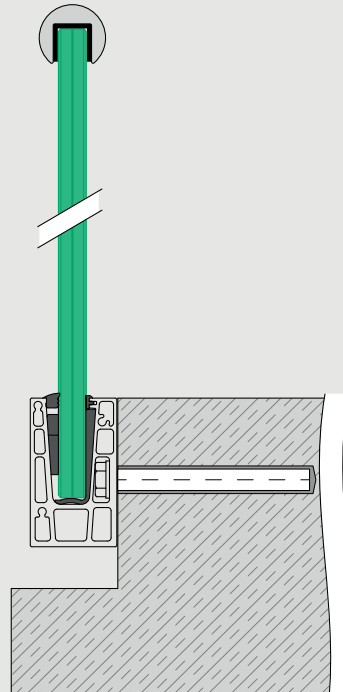

Profil de garde-corps

Safety Wedge System (set de cales en caoutchouc)

Pour une fixation du verre

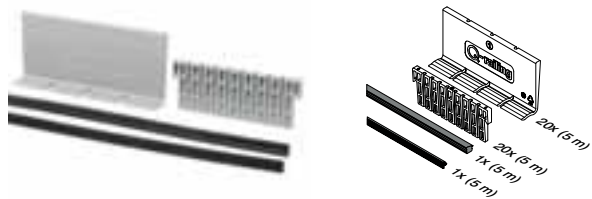

MOD 6600

Accessoires

Pour verre monolithique	T	
206600-050-12	12	L = 5 m
206600-050-15	15	L = 5 m

Pour verre feuilleté

206600-050-13	12,76	L = 5 m
206600-050-14	13,52	L = 5 m
206600-050-17	16,76	L = 5 m
206600-050-18	17,52	L = 5 m

Accessoires

Outil multi-fonctions Easy Glass®



MOD 1001

Accessoires

	Q	
201001	Q-71	1

Profil de garde-corps

Goujons d'assemblage

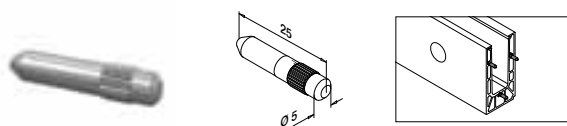

MOD 3005

316 Brut

OUTDOOR

143005		6
--------	--	---



Q-INFO MOD 6600

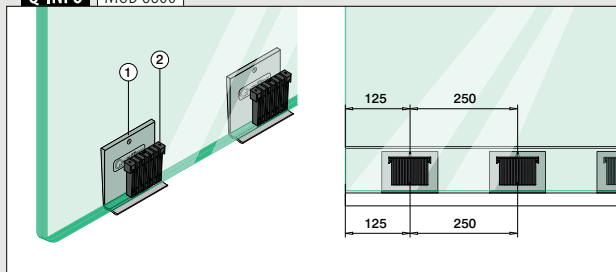

Q-INFO MOD 1001

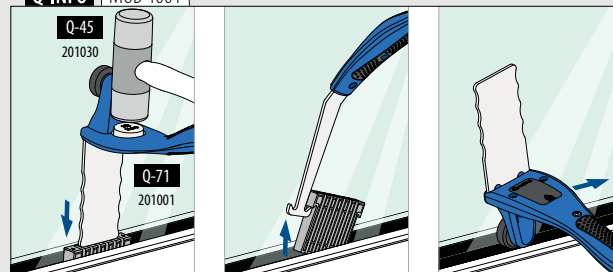



Profil de garde-corps

Profil de sol, montage au sol

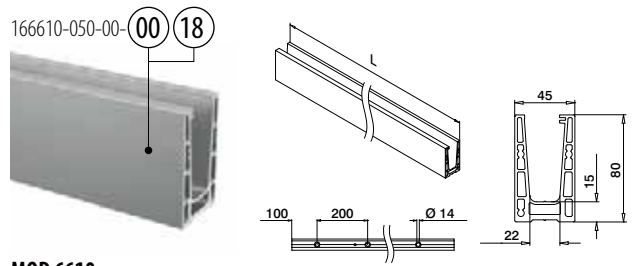
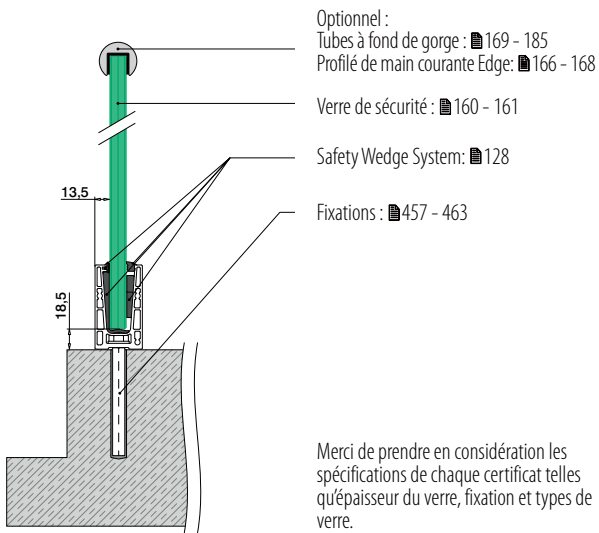

MOD 6610

Aluminium	Brut		
166610-050-00-00	█ 457 - 463		L = 5 m
Aluminium	Brossé, anodisé		
OUTDOOR			
166610-050-00-18	█ 457 - 463		L = 5 m



International Design
Modèle Protection

Profil de garde-corps

Angles, montage au sol

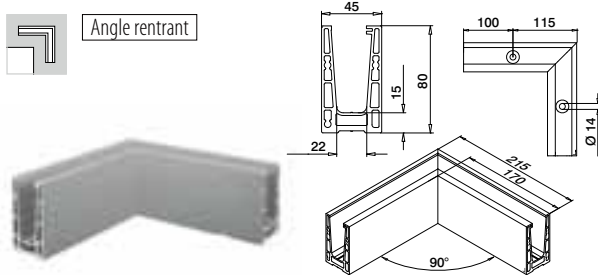

MOD 6611

Aluminium	Brossé, anodisé		
OUTDOOR			
166611-01-18	█ 457 - 463	1	

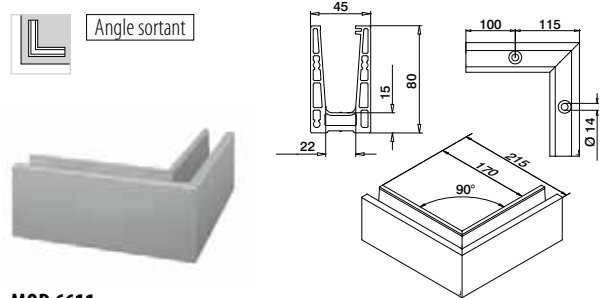

MOD 6611

Aluminium	Brossé, anodisé		
OUTDOOR			
166611-02-18	█ 457 - 463	1	



Profil de garde-corps

Embouts, montage au sol

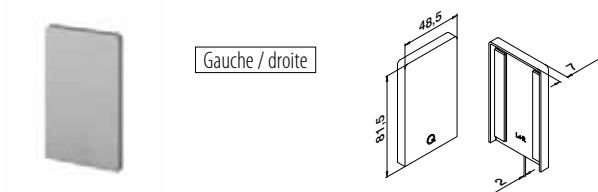

MOD 6612

Aluminium	Brut		
	Ruban adhésif		
166612-00-00	Fourni	1	
Aluminium	Brossé, anodisé		
OUTDOOR			
166612-00-18	Pré-collé	1	

Q-INFO MOD 6610

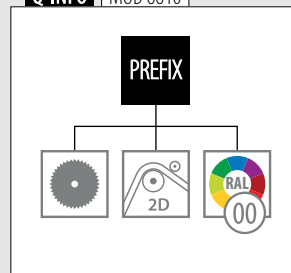

Q-INFO MOD 6610 / 6611

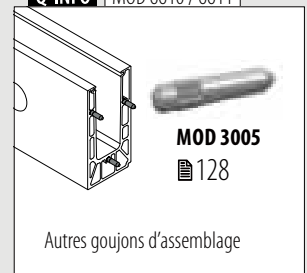

Q-INFO MOD 6612

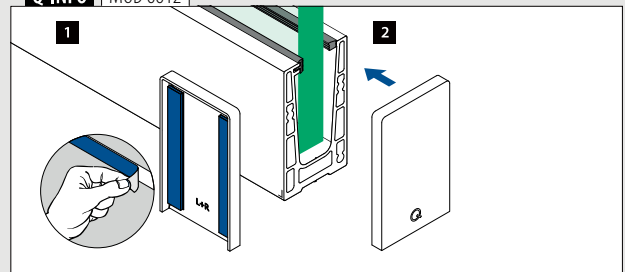

Profil de sol, montage latéral

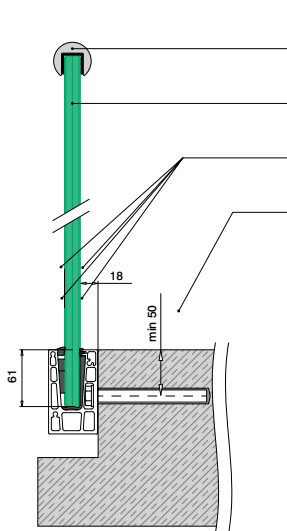

- Optionnel :
 Tubes à fond de gorge : ■ 169 - 185
 Profilé de main courante Edge: ■ 166 - 168
- Verre de sécurité : ■ 160 - 161
- Safety Wedge System: ■ 128
- Fixations : ■ 457 - 463

Merci de prendre en considération les spécifications de chaque certificat telles qu'épaisseur du verre, fixation et types de verre.

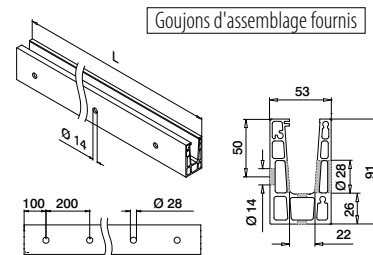
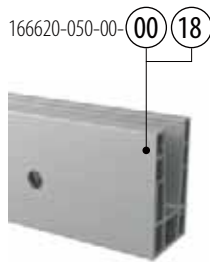

Goujons d'assemblage fournis

MOD 6620

Aluminium	Brut	X		
166620-050-00-00	100	■ 457 - 463		L = 5 m
Aluminium	Brossé, anodisé			
OUTDOOR				
166620-050-00-18	100	■ 457 - 463		L = 5 m



International Design
Modèle Protection

Angles, montage latéral

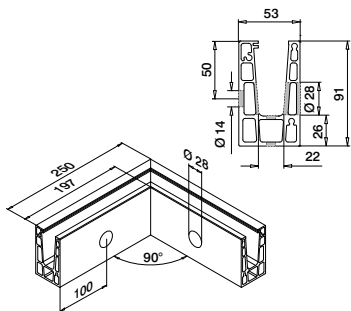

MOD 6621

Aluminium	Brossé, anodisé			
OUTDOOR				
166621-01-18	■ 457 - 463	1		

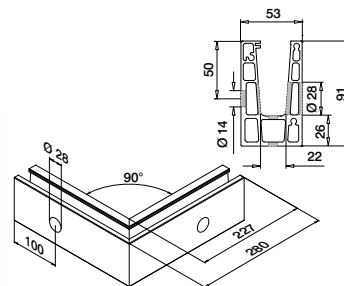

MOD 6621

Aluminium	Brossé, anodisé			
OUTDOOR				
166621-02-18	■ 457 - 463	1		



Q-INFO MOD 6620

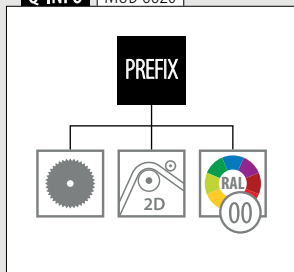

Q-INFO Aluminium



Q-INFO

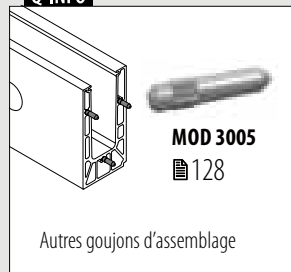

Profil de garde-corps

Embouts, montage latéral

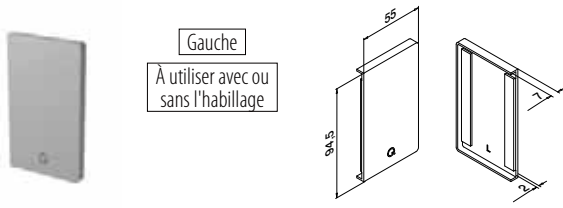

MOD 6622

Aluminium	Brut		
	Ruban adhésif		
166622-01-00	Fourni	1	
Aluminium	Brossé, anodisé		
OUTDOOR			
166622-01-18	Pré-collé	1	

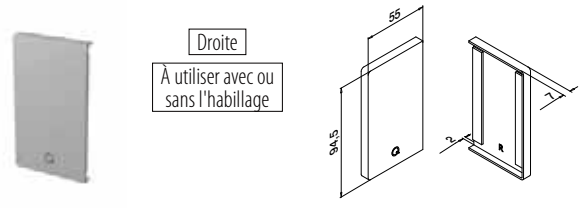

MOD 6622

Aluminium	Brut		
	Ruban adhésif		
166622-02-00	Fourni	1	
Aluminium	Brossé, anodisé		
OUTDOOR			
166622-02-18	Pré-collé	1	

Profil de garde-corps

Habillage, montage latéral



MOD 6625

Aluminium	Brut		
	Ruban adhésif		
166625-050-00	Non compris*	L = 5 m	
Aluminium	Brossé, anodisé		
OUTDOOR			
166625-050-18	Pré-collé	L = 5 m	



*Commander MOD 1360 (ruban adhésif)

Accessoires

Ruban adhésif acrylique



MOD 1360

	Accessoires			
	Q	W	L	
201360	Q-53	9	33 m (pour 11 m d'habillage)	1

Q-INFO | MOD 6625

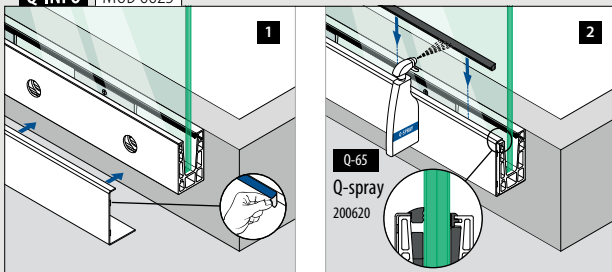

Q-INFO | MOD 6625-050-00 / 1360



Q-INFO | Aluminium

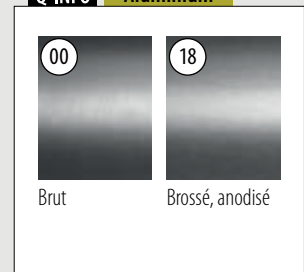

Profils de drainage, montage latéral

8 pièces pour un profilé de sol de 5 mètres

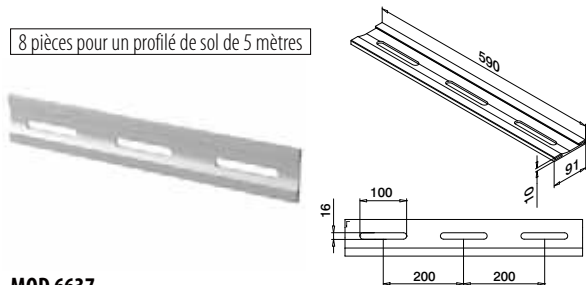

MOD 6637

Aluminium Brossé, anodisé
OUTDOOR

166637-18



4

Cale, montage latéral

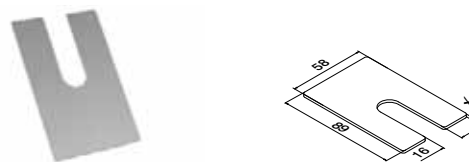

MOD 6636

Aluminium Brut

X



166636-001

1

100

166636-002

2

100

166636-003

3

100

Embouts, montage latéral



À utiliser sans l'habillage

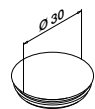

MOD 8538

Plastique Aluminium blanc RAL 9006

INDOOR

158538-36



10

Q-INFO MOD 6637

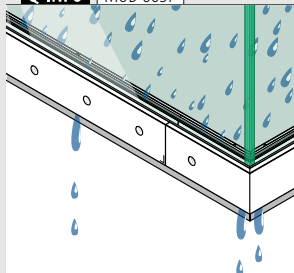

Informations sur l'assemblage :



<https://q-ne.ws/Up23>

Q-INFO MOD 8538

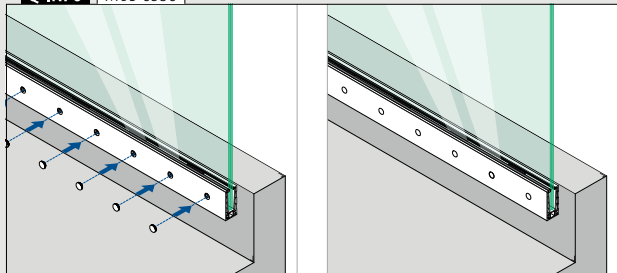

Q-INFO MOD 6636

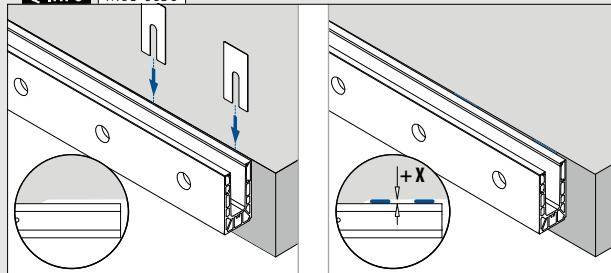



Conçu pour : Utilisation faible à moyenne
Utilisation : Intérieur et extérieur
Variantes : Montage entre panneau
Applications : Balcons et protection de fenêtres
Matériau : Aluminium (brut de laminage, effet argenté mat, brossé anodisé ou thermolaqué en RAL 9005 noir), acier (thermolaqué RAL 7047 ou revêtement électrophorétique), inox (brossé ou thermolaqué en RAL 9005 noir)

Épaisseur de verre : 8 à 13,52 mm

Retrouvez toutes les informations sur Easy Glass Hybrid en ligne :



<https://q-ne.ws/Hybrid23>

EASY GLASS® HYBRID

Le garde-corps invisible à fixation murale

Easy Glass® Hybrid est parfait si vous souhaitez installer un garde-corps entre deux murs, comme par exemple sur un balcon non saillant. Avec son profil de sol minimaliste et ses raccords robustes aux deux murs, ce système crée une structure transparente et solide sur des plus grandes largeurs de portée.



Easy Glass® Hybrid	BE
Max. charge linéaire (kN/m)	1,0
Max. vent (mètre)	3,0

Merci de prendre en considération les spécifications de chaque certificat telles qu'épaisseur du verre, fixation.

Tests/calculs/certificats internationaux:



- 1 Idéal pour créer des garde-corps entre des murs, Easy Glass Hybrid est la solution de garde-corps en verre la plus minimaliste pouvant être montée entre deux parois.
- 2 Créez des surfaces vitrées continues pouvant atteindre jusqu'à 3 000 mm de longueur.
- 3 Easy Glass Hybrid comprend des finitions assorties pour ses profils de sol et tubes à fond de gorge.



EASY GLASS® HYBRID

Hybrid

Montage au sol

- Pour une installation entre deux murs

📄 136

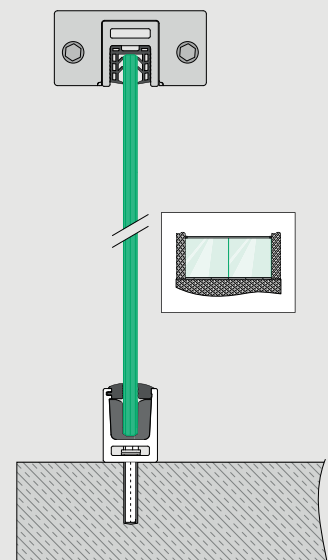

Profil de garde-corps

Profil de sol, montage au sol - entre deux murs

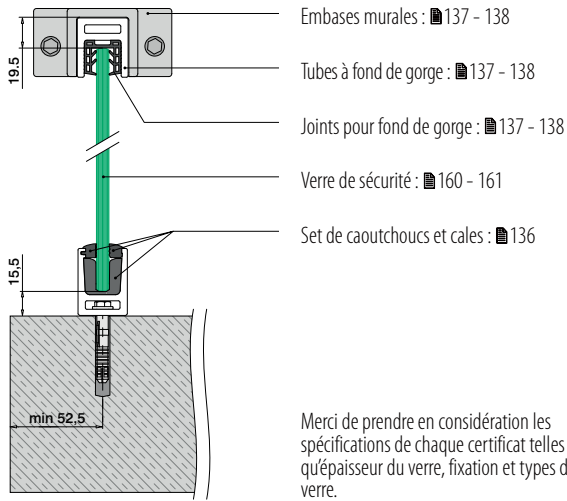

Merci de prendre en considération les spécifications de chaque certificat telles qu'épaisseur du verre, fixation et types de verre.

Profil de garde-corps

Embouts



MOD 6912

Code	Matériau	État	Quantité
166912-00-00	Aluminium	Brut	2
	Ruban adhésif		
		Fourni	
166912-00-08	Aluminium	Effet argenté mat	2
	OUTDOOR		
166912-00-08	Aluminium	Pré-collé	2
	OUTDOOR		
166912-00-18	Aluminium	Brossé, anodisé	2
	OUTDOOR		
166912-00-18	Aluminium	Pré-collé	2
	OUTDOOR		
166912-00-18	Aluminium	Black Line	2
	OUTDOOR		
166912-00-82	Aluminium	Black Line	2
	OUTDOOR		
166912-00-82	Aluminium	Black Line	2
	OUTDOOR		

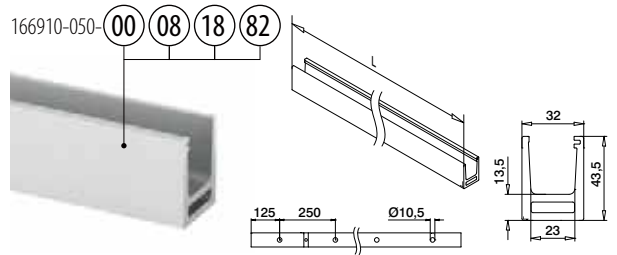

MOD 6910

Code	Matériau	État	Quantité	Longueur
166910-050-00	Aluminium	Brut	468	L = 5 m
166910-050-08	Aluminium	Effet argenté mat	468	L = 5 m
	OUTDOOR			
166910-050-18	Aluminium	Brossé, anodisé	468	L = 5 m
	OUTDOOR			
166910-050-18	Aluminium	Black Line	468	L = 5 m
	OUTDOOR			
166910-050-82	Aluminium	Black Line	468	L = 5 m
	OUTDOOR			



International Design
Modèle Protection

Profil de garde-corps

Set de caoutchoucs et cales

Pour une fixation du verre

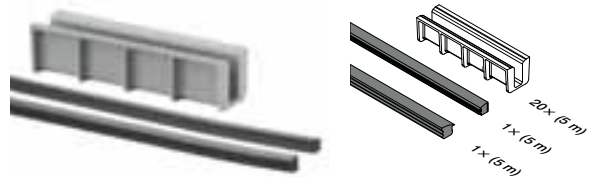

MOD 6910

Accessoires		
Pour verre monolithique		
206910-08	8	L = 5 m
206910-10	10	L = 5 m
Pour verre feuilleté		
206910-08	8,76 - 9,52	L = 5 m
206910-10	10,76 - 11,52	L = 5 m
206910-13	12,76 - 13,52	L = 5 m

International Design Modèle Protection

Q-INFO MOD 6910

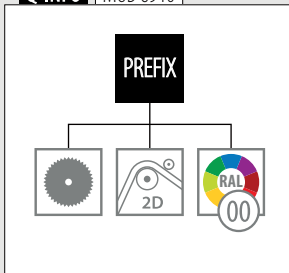

Q-INFO MOD 6912

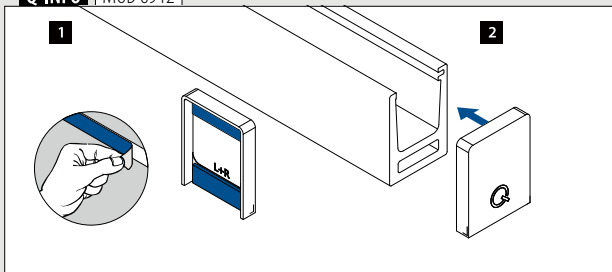

SELL OUT Seulement jusqu'à épuisement des stocks.

Q-INFO Aluminium

Code	État	Matériau
00	Brut	Aluminium
08	Effet argenté mat	Aluminium
18	Brossé, anodisé	Aluminium
82	Noir, mat, texture	Thermolaqué

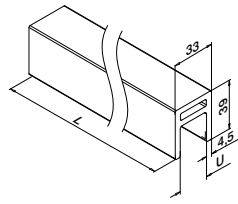
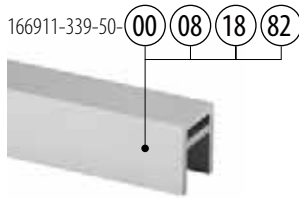
**MOD 6911****Aluminium** Brut**U**

166911-339-50-00 24 L = 5 m

Aluminium Effet argenté mat**OUTDOOR**

SELL OUT

166911-339-50-08 24 L = 5 m

Aluminium Brosse, anodisé**OUTDOOR**

NEW

166911-339-50-18 24 L = 5 m

Aluminium Black Line**OUTDOOR**

NEW

166911-339-50-82 24 L = 5 m

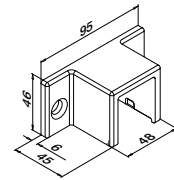

International Design Modèle Protection

**MOD 6515****316** Inox brossé**OUTDOOR**

146515-339-12 QS-214 468

2

316 Black Line**OUTDOOR**

146515-339-82 QS-214 468

2

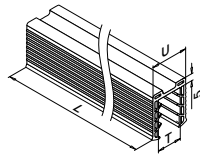
**MOD 5124****Accessoires**

U = 24 mm

Pour verre monolithique **T**

205124-050-08 8 - 10 L = 5 m

Pour verre feuilleté

205124-050-08 8,76 - 10,76 L = 5 m

205124-050-11 11,52 - 13,52 L = 5 m

Q-INFO MOD 6911

PREFIX

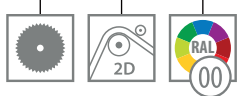
**Q-INFO** 316

12

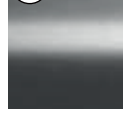

Inox brossé

82

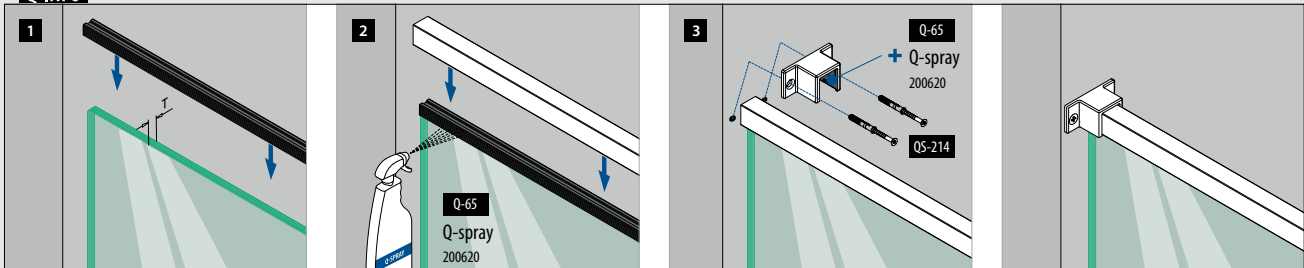

Noir, mat, texture

Q-INFO

Mains-courantes

Tubes à fond de gorge

HYBRID 65x40

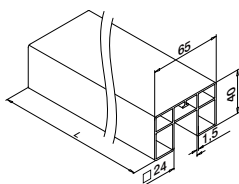
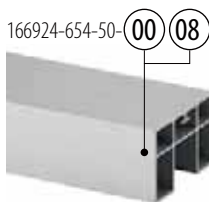

MOD 6924

Aluminium	Brut		
166924-654-50-00	65 x 40		L = 5 m
Aluminium	Effet argenté mat		
OUTDOOR			
166924-654-50-08	65 x 40		L = 5 m



International Design Modèle Protection

Mains-courantes

Embases murales pour tube

HYBRID 65x40

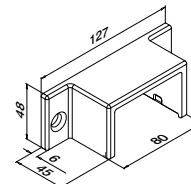

MOD 6515

Acier	Thermolaqué RAL 7047		
OUTDOOR			
116515-654-34	QS-214 468		2
Acier	Revêtement électrophorétique		
116515-654-30	QS-214 468		2



Mains-courantes

Joints pour fond de gorge

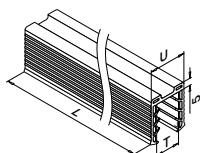

MOD 5124

Accessoires			
U = 24 mm			
Pour verre monolithique T			
205124-050-08	8 - 10		L = 5 m
Pour verre feuilleté			
205124-050-08	8,76 - 10,76		L = 5 m
205124-050-11	11,52 - 13,52		L = 5 m

SELL OUT Seulement jusqu'à épuisement des stocks.

Q-INFO MOD 6924

PREFIX

Q-INFO MOD 6924

254

Ajoutez un éclairage LED (Linear Light) avec un tube à fond de gorge MOD 6926

Q-INFO Acier MOD 6515

30 Revêtement électrophorétique

34 RAL 7047 Thermolaqué

Telegris 4, brillant de soie, uni

L'e-revêtement, également appelé traitement par électrophorèse, est une fine couche de 15 µ qui protège (apprêt) les produits en acier. Après l'e-revêtement, le produit reçoit le traitement de surface final, qui peut être plaqué ou thermolaqué.

Q-INFO

1. Positionner le rail sur le verre.

2. Appliquer le spray Q-65 (200620) sur le rail.

3. Visser le rail avec les vis Q-65 (200620) et QS-214 (468).





Utilisation : Intérieur et extérieur
Applications : Balcons, galeries, passerelles, cloisons et escaliers
Matériau : Inox (brossé, poli miroir ou thermolaqué en RAL 9005 noir)
Épaisseur de verre : 12 à 21,52 mm

Retrouvez toutes les informations sur pinces à verre de sol Easy Glass en ligne :



<https://q-ne.ws/BaseGlassClamps23>

EASY GLASS®

PINCES À VERRE DE SOL

UNE ALTERNATIVE
INGÉNIEUSE

MOD 6100

144

- Utilisation légère
- Avec trous oblongs
- Traverse le verre



MOD 6200

145

- Utilisation légère
- Avec trous oblongs
- Traverse le verre

Pour un garde-corps en verre au look unique



MOD 6000

142

- Utilisation légère
- Installation à ancrage unique
- Calage en verre (pas de perçage du verre)
- Goupille de sécurité en option
- Niveau à bulle intégré
- Aucune vis apparente



MOD 6400

143

- Utilisation légère à moyenne
- Installation à double ancrage
- Calage en force (pas de perçage du verre)
- Aucune goupille de sécurité nécessaire
- Aucune vis apparente

Tests/calculs/certificats internationaux:



Base du garde-corps

Pinces à verre de sol - MOD 6000

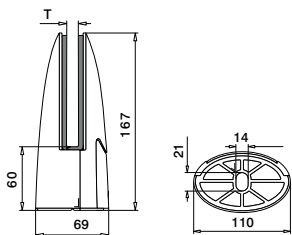

MOD 6000

316	Inox brossé		
OUTDOOR	T		
146000-12	Voir T en MOD 5060	457 - 463	1
316	Poli miroir		
OUTDOOR			
146000-10	Voir T en MOD 5060	457 - 463	1

International Design Modèle Protection

Accessoires

Goupilles de sécurité

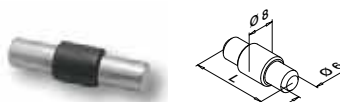

Optionnel pour MOD 6000

MOD 5015

	L	
205015-24	30	4

Base du garde-corps

Cales caoutchouc pour MOD 6000



2 pièces par pince à verre

MOD 5060

Accessoires		
Pour verre monolithique	T	
205060-12	12	2
205060-15	15	2
Pour verre feuilleté		
205060-13	12,76	2
205060-14	13,52	2
205060-17	16,76	2
205060-18	17,52	2

Seulement jusqu'à épuisement des stocks.

Q-INFO MOD 5015

Goupille de sécurité en option. Commander séparément goupilles et matériel de fixation.



MOD 6000

Pinces à verre de sol - MOD 6400

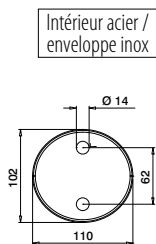
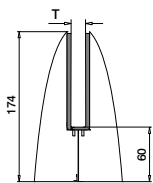

MOD 6400

316	Inox brossé			
OUTDOOR	T			
146400-12	Voir T en MOD 5064	457 - 463	1	
316	Poli miroir			
OUTDOOR	T			
SELL OUT 146400-10	Voir T en MOD 5064	457 - 463	1	



International Design
Modèle Protection

Cales caoutchouc pour MOD 6400



1 set par
pince à verre

MOD 5064

Accessoires		
Pour verre monolithique	T	
205064-15	15	1
205064-19	19	1
Pour verre feuilleté		
205064-17	16,76	1
205064-18	17,52	1
205064-21	20,76	1
205064-22	21,52	1

Q-INFO 316

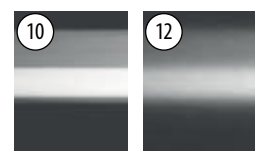

Poli miroir

Inox brossé



MOD 6400

Base du garde-corps

Pinces à verre de sol - MOD 6100

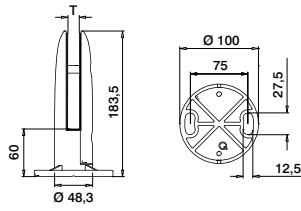

MOD 6100

316		Inox brossé		
OUTDOOR		T		
146100-12		Voir T en MOD 5061	457 - 463	1
316		Poli miroir		
OUTDOOR				
146100-10		Voir T en MOD 5061	457 - 463	1

SELL OUT



Base du garde-corps

Cache-embases pour MOD 6100

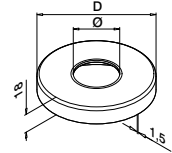

MOD 0512

316		Inox brossé		
OUTDOOR		Ø	D	
140512-048-12		48,3	105	2
316		Poli miroir		
OUTDOOR				
140512-048-10		48,3	105	2

SELL OUT

Base du garde-corps

Cales caoutchouc pour MOD 6100



2 pièces par pince à verre

MOD 5061

Accessoires		
Pour verre monolithique	T	
205061-12	12	2
Pour verre feuilleté		
205061-13	12,76	2
205061-17	16,76	2
205061-18	17,52	2



MOD 6100

SELL OUT Seulement jusqu'à épuisement des stocks.

Q-INFO

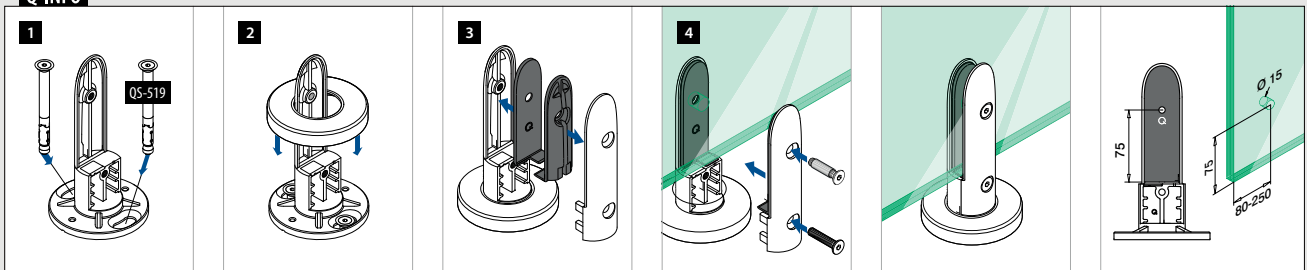

Base du garde-corps
Pincès à verre de sol - MOD 6200

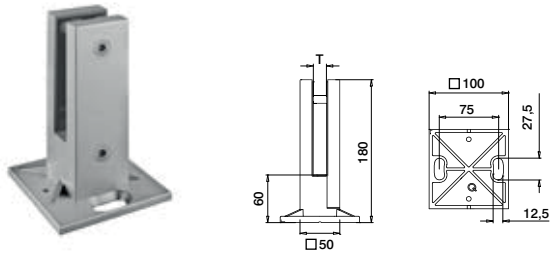

MOD 6200

316		Inox brossé		
OUTDOOR		T		
146200-12	Voir T en MOD 5062		457 - 463	1
316		Poli miroir		
OUTDOOR				
	146200-10	Voir T en MOD 5062	457 - 463	1
316		Black Line		
OUTDOOR				
	146200-82	Voir T en MOD 5062	457 - 463	1



Base du garde-corps
Cache-embases pour MOD 6200



MOD 4562

316		Inox brossé	
OUTDOOR			
	144562-12		2
316		Poli miroir	
OUTDOOR			
	144562-10		2
316		Black Line	
OUTDOOR			
	144562-82		2

Base du garde-corps
Cales caoutchouc pour MOD 6200



2 pièces par
pince à verre

MOD 5062

Accessoires		
Pour verre monolithique	T	
205062-12	12	2
205062-15	15	2
Pour verre feuilleté		
205062-13	12,76	2
205062-14	13,52	2
205062-17	16,76	2
205062-18	17,52	2

Q-INFO 316

10

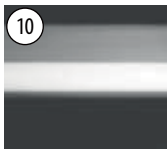

Poli miroir

12

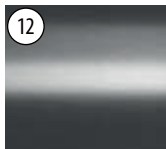

Inox brossé

82 RAL 9005



Noir, mat,
texture

Thermolaqué

Q-INFO

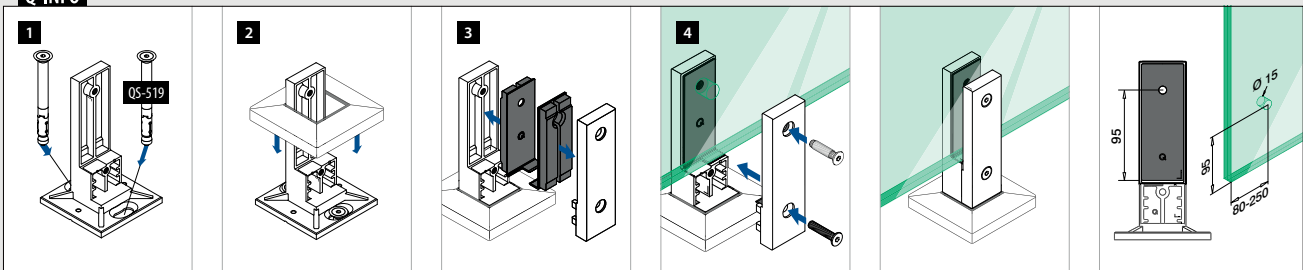



Conçu pour : Utilisation faible à moyenne
Utilisation : Intérieur et extérieur
Variantes : Montage au sol
Applications : Balcons, galeries, passerelles et cloisons
Matériau : Acier inoxydable 316 (microbillé et brossé inox brossé)
Épaisseur de verre : 15 à 21,52 mm

Retrouvez toutes les informations sur Easy Glass Air en ligne :



<https://q-ne.ws/Air23>

EASY GLASS[®] AIR



Pour faire la différence

Easy Glass® Air vous permet de donner votre signature architecturale à vos bâtiments commerciaux ou résidentiels ! Ce garde-corps en verre dispose d'une pince de sol ultramoderne aux éléments inimitables. La conception légère et épurée des pinces et des raccords abrasés à l'aide de billes de verre donne l'impression que les panneaux de verre flottent dans l'air. Le résultat : une élégance à l'état pur et une transparence maximale.

Tests/calculs/certificats internationaux:



- 1 Les formes de la pince à verre et de la pince de liaison de Easy Glass Air sont assorties, ce qui en fait un produit unique sur le marché.
- 2 Le système propose une solution complète pour les demi-pinces avec des caches pour les extrémités.

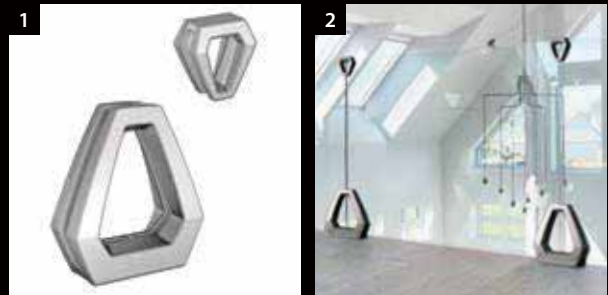

EASY GLASS® AIR MODELES AU CHOIX

Air
Pince de sol

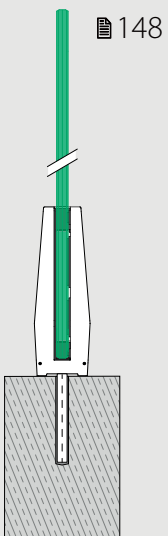

Air
Pince de sol avec pince de liaison

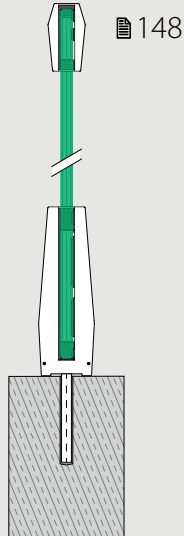

Air
Pince de sol avec pince de liaison, adaptateur pour main-courante

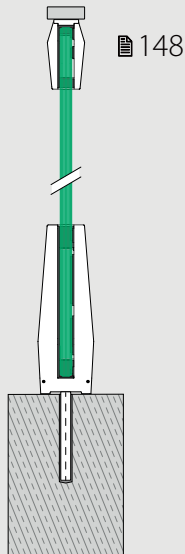

Air
Pince de sol avec tube à fond de gorge, profil en u ou profilé de main courante Edge

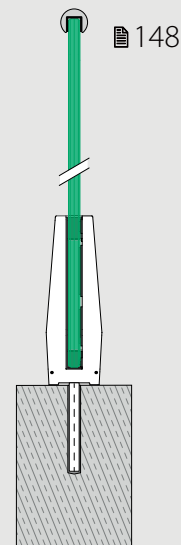

Base du garde-corps

Pinces à verre de sol

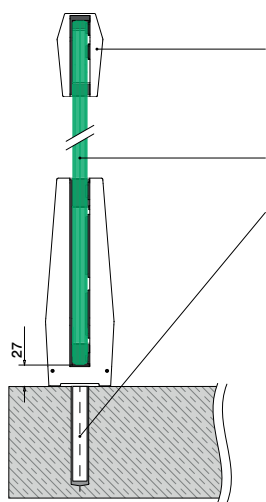

Optionnel :
 Tubes à fond de gorge : ■ 169 - 185
 Pince de liaison MOD 6510 : ■ 148
 Profilé de main courante Edge: ■ 166 - 168
 Mains-courante 60x20: ■ 149

Verre de sécurité : ■ 160 - 161

Fixations : ■ 457 - 463

Merci de prendre en considération les spécifications de chaque certificat telles qu'épaisseur du verre, fixation et types de verre.

Base du garde-corps

Pinces à verre de sol

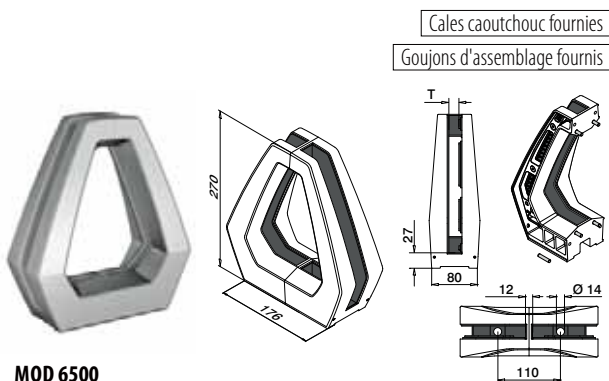

MOD 6500

316 Inox brossé + grenailage aux microbilles de verre

OUTDOOR

146500-12 15 - 21,52 ■ 457 - 463 1



International Design Modèle Protection

Mains-courantes

Pinces de liaison

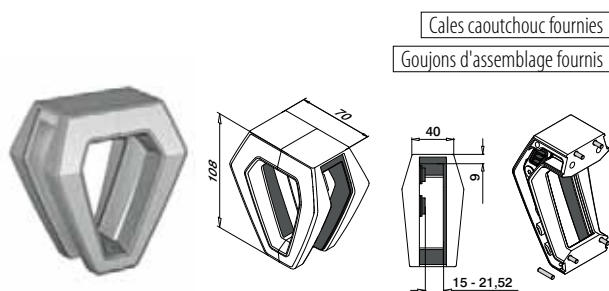

MOD 6510

316 Inox brossé + grenailage aux microbilles de verre

OUTDOOR

146510-12 1



International Design Modèle Protection

Base du garde-corps

Embouts (pinces à verre de sol)

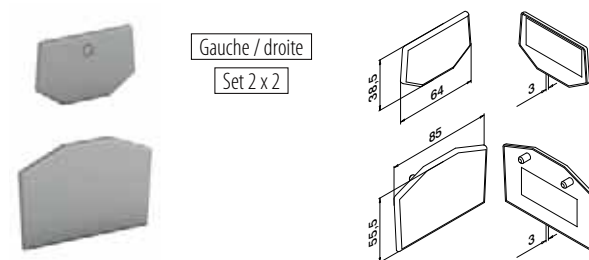

MOD 6502

316 Grenailage aux microbilles de verre

OUTDOOR

146502-02 Set

International Design Modèle Protection

Mains-courantes

Embouts (pinces de liaison)

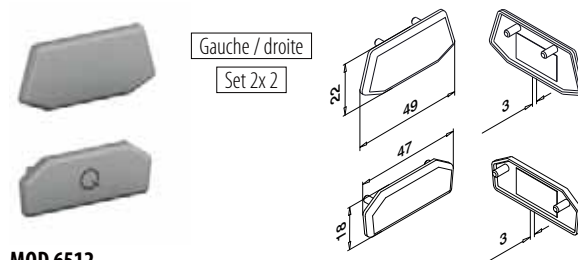

MOD 6512

316 Grenailage aux microbilles de verre

OUTDOOR

146512-01 Set

International Design Modèle Protection

Adaptateurs pour main-courante

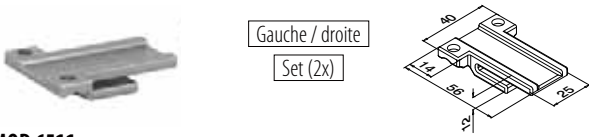

MOD 6511

316	Grenailage aux microbilles de verre
OUTDOOR	T
146511-02	15 - 21,52
	QS-13 472
	Set



International Design Modèle Protection

Embouts



MOD 5728 - EASY HIT®

316	Inox brossé
OUTDOOR	Pour □
145728-062-12	60 x 20 x 2,0
	2



International Design Modèle Protection

Tubes

Q-TUBE

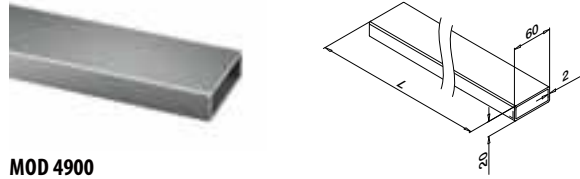

MOD 4900

316	Inox brossé
OUTDOOR	□
144900-062-25-12	60 x 20 x 2,0
	L = 2,5 m
144900-062-50-12	60 x 20 x 2,0
	L = 5 m



International Design Modèle Protection

Embases murales pour tube

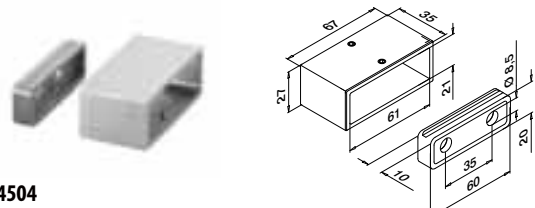

MOD 4504

316	Inox brossé
OUTDOOR	Pour □
144504-062-12	60 x 20 x 2,0
	QS-55 470 / QS-27 472
	2



International Design Modèle Protection

Q-INFO MOD 4900

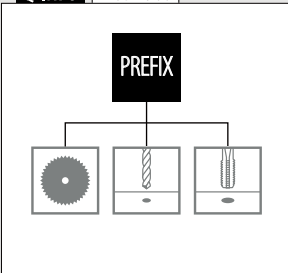

Q-INFO MOD 4504

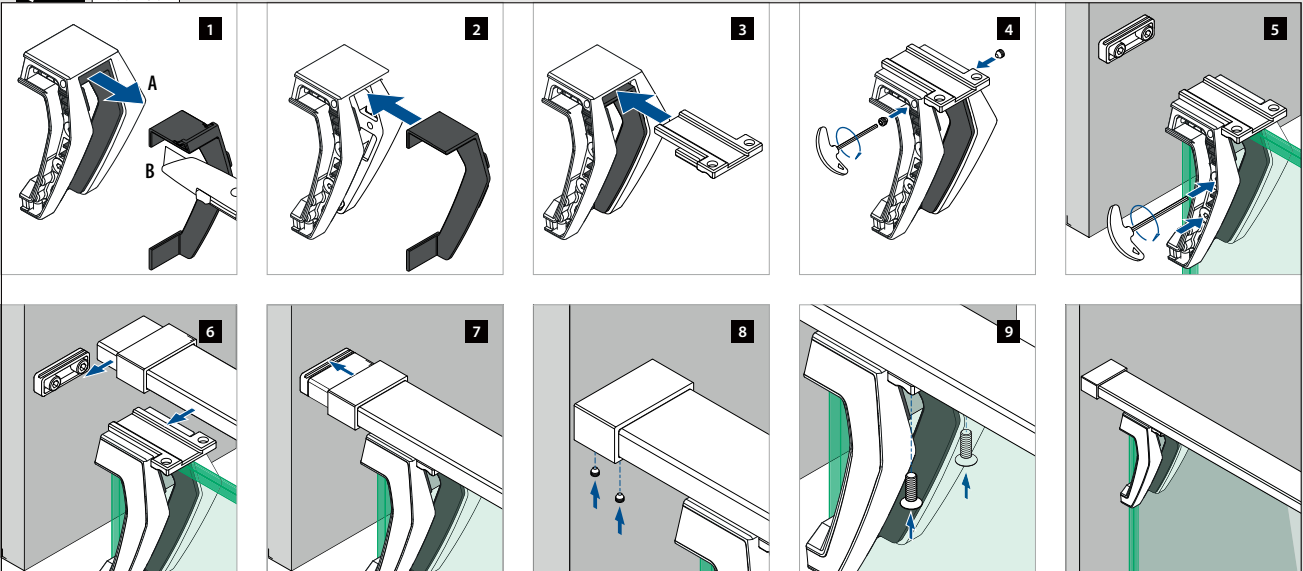



Conçu pour : Utilisation faible à moyenne
Utilisation : Intérieur et extérieur
Variantes : Montage au sol, latéral et engravé
Applications : Balcons, galeries, passerelles, cloisons, escaliers, pare-vents et protection de fenêtres
Matériau : Inox (brossé, poli miroir ou thermolaqué en RAL 9005 noir), zamak (brut ou aspect inox brossé)
Épaisseur de verre : 12 à 21,52 mm

Retrouvez toutes les informations sur adaptateurs Easy Glass à verre en ligne :



<https://q-ne.ws/GlassAdapters23>

EASY GLASS®

ADAPTATEURS À VERRE

SE LIMITER À L'ESSENTIEL

MOD
0745-0748

154 - 155

- Différents diamètres et différentes distances de mur

MOD 4747

158

- Différentes épaisseurs d'entretoises

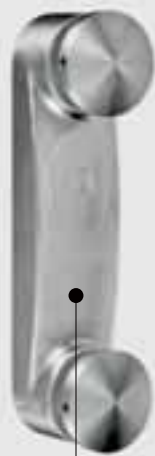

MOD 4762

158

- Installation à ancrage unique (deuxième ancrage en option)
- Niveau à bulle intégré



MOD 0760-0766

156

- Installation à ancrage unique
- L'adaptateur MOD 0766 possède un angle ajustable
- Les adaptateurs MOD 0760 et 0762 sont dotés d'un niveau à bulle intégré

MOD 0749

152

- Possibilité d'aligner le verre à chaque étape de l'installation
- Ancrage mécanique pour les murs en béton ou boulonnage sur une ossature métallique



Ajustable



MOD 0763

159

- Installation à ancrage unique (deuxième ancrage en option)
- Un adaptateur et une pince à verre en un seul composant (déplacer la goupille unique pour changer de fonction)

Adaptateurs à verre

Adaptateurs à verre

Orientables

Ø 50

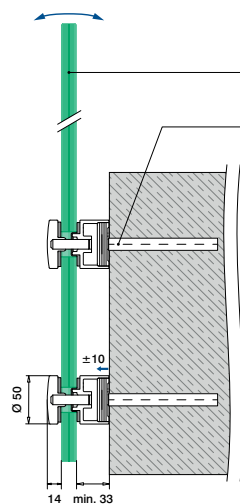

Verre de sécurité : 160 - 161

Fixations : 457 - 463

Merci de prendre en considération les spécifications de chaque certificat telles qu'épaisseur du verre, fixation et types de verre.

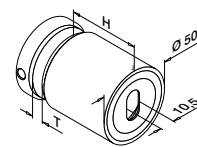

MOD 0749

304		Inox brossé			
INDOOR	H	T			
130749-030-12	30	12 - 25,52	457 - 463		
130749-040-12	40	8 - 25,52	457 - 463		
130749-050-12	50	8 - 25,52	457 - 463		

304		Black Line			
INDOOR					
NEW 130749-030-82	30	12 - 25,52	457 - 463		
NEW 130749-040-82	40	8 - 25,52	457 - 463		
NEW 130749-050-82	50	8 - 25,52	457 - 463		

316		Inox brossé			
OUTDOOR					
140749-030-12	30	12 - 25,52	457 - 463		
140749-040-12	40	8 - 25,52	457 - 463		
140749-050-12	50	8 - 25,52	457 - 463		
140749-100-12	100	8 - 25,52	457 - 463		

316		Black Line			
OUTDOOR					
NEW 140749-030-82	30	12 - 25,52	457 - 463		
NEW 140749-040-82	40	8 - 25,52	457 - 463		
NEW 140749-050-82	50	8 - 25,52	457 - 463		

316		Poli miroir			
OUTDOOR					
140749-050-10	50	8 - 25,52	457 - 463		



Adaptateurs à verre

Ecrou de serrage

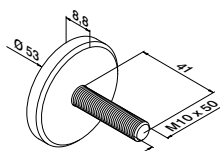

MOD 0741

316		Brut		
OUTDOOR				
140741-150				2



Q-INFO

316

304

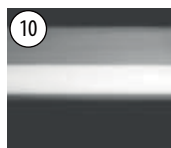

10
Poli miroir

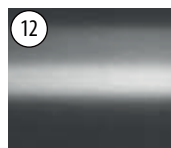

12
Inox brossé



82 RAL 9005
Noir, mat, texture

Thermolaqué

Q-INFO

MOD 0749

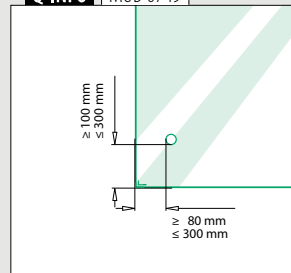

Q-INFO

MOD 0741



MOD 5030

475

Autres cales caoutchouc pour adaptateurs à verre

Q-INFO

MOD 0749

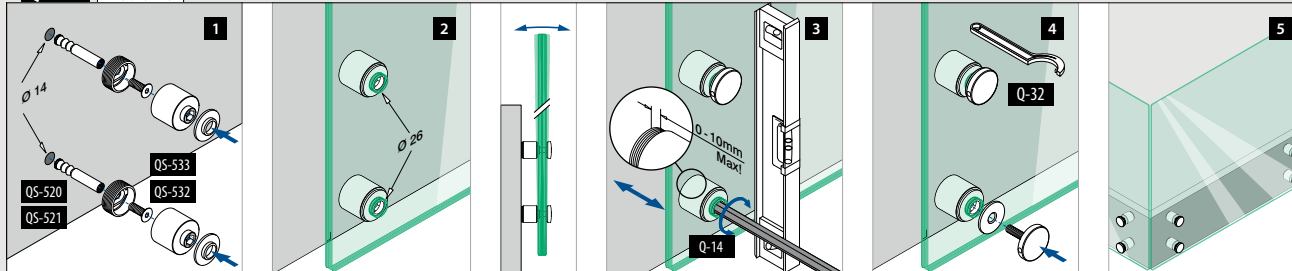

Q-INFO

MOD 0741 / 0749

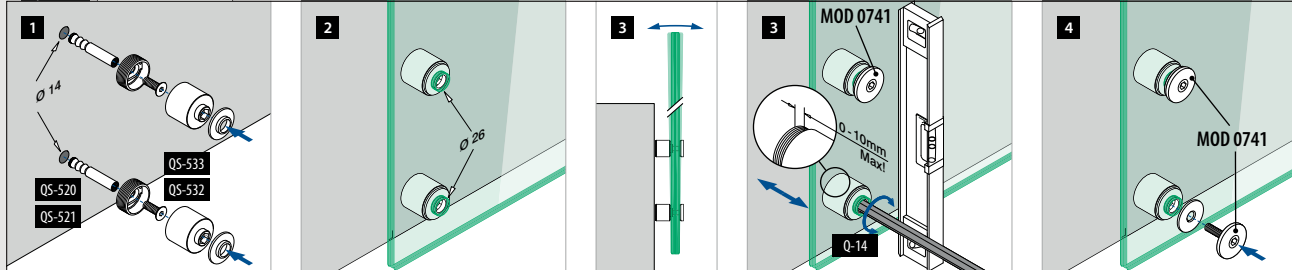



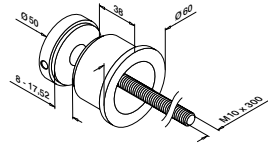
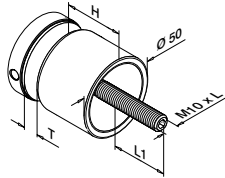

MOD 0747

304		Inox brossé				
INDOOR	H	T	L	L1		
130747-010-12	10	8 - 17,52	50	11 - 20	2	
130747-020-12	20	8 - 25,52	70	13 - 31	2	
130747-030-12	30	8 - 25,52	80	13 - 31	2	
130747-040-12	40	8 - 17,52	80	11 - 22	2	
130747-050-12	50	8 - 17,52	90	11 - 22	2	

304		Black Line				
INDOOR						
NEW 130747-010-82	10	8 - 17,52	50	11 - 20	2	
NEW 130747-030-82	30	8 - 25,52	80	13 - 31	2	

316		Inox brossé				
OUTDOOR						
140747-010-12	10	8 - 17,52	50	11 - 20	2	
140747-020-12	20	8 - 25,52	70	13 - 31	2	
140747-030-12	30	8 - 25,52	80	13 - 31	2	
140747-040-12	40	8 - 17,52	80	11 - 21	2	
140747-050-12	50	8 - 17,52	90	11 - 21	2	

316		Black Line				
OUTDOOR						
NEW 140747-010-82	10	8 - 17,52	50	11 - 20	2	
NEW 140747-030-82	30	8 - 25,52	80	13 - 31	2	

316		Poli miroir				
OUTDOOR						
140747-030-10	30	8 - 25,52	80	13 - 31	2	

Zamak		Brut				
INDOOR						

SELL OUT 100747-00	10	8 - 17,52	50	11 - 20	2
--------------------	----	-----------	----	---------	---

Zamak		Aspect inox brossé				
OUTDOOR						

SELL OUT 100747-20	10	8 - 17,52	50	11 - 20	2
--------------------	----	-----------	----	---------	---



MOD 0744

316		Inox brossé			
OUTDOOR					
140744-12					2



SELL OUT Seulement jusqu'à épuisement des stocks.

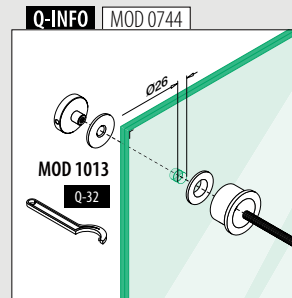
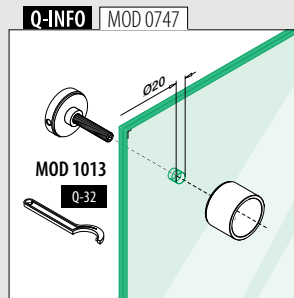
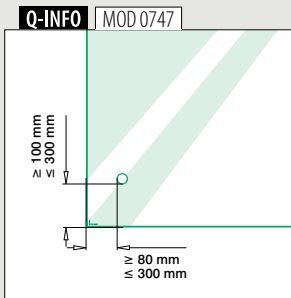

Q-INFO 304 316

10 Poli miroir	12 Inox brossé	82 RAL 9005 Thermolaqué
--------------------------	--------------------------	-----------------------------------

Q-INFO Zamak

00 Brut	20 Aspect inox brossé
-------------------	---------------------------------

Q-INFO

MOD 1013 483
Clé à ergot

Adaptateurs à verre

Ø 60

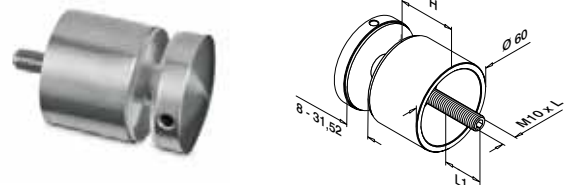
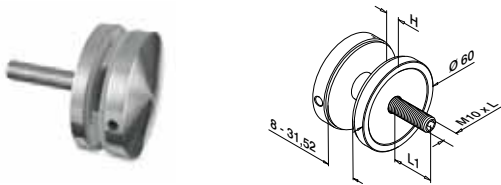

MOD 0745

304		Inox brossé			
INDOOR	H	L	L1		
130745-010-12	10	70	17 - 41		2
316		Inox brossé			
OUTDOOR					
140745-010-12	10	70	17 - 41		2
316		Poli miroir			
OUTDOOR					
140745-010-10	10	70	17 - 41		2

MOD 0745

304		Inox brossé			
INDOOR	H	L	L1		
130745-030-12	30	90	17 - 41		2
130745-050-12	50	110	17 - 41		2
316		Inox brossé			
OUTDOOR					
140745-030-12	30	90	17 - 41		2
140745-050-12	50	110	17 - 41		2

SELL OUT



Adaptateurs à verre

Ø 70

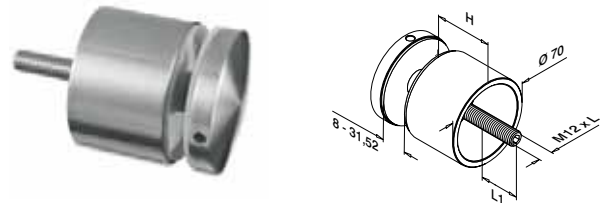
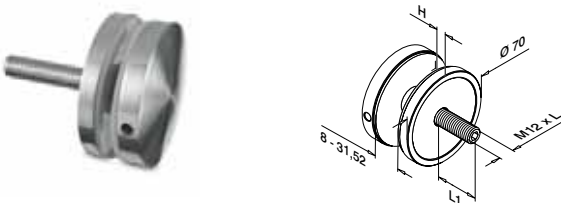

MOD 0748

304		Inox brossé			
INDOOR	H	L	L1		
130748-010-12	10	70	17 - 41		2
316		Inox brossé			
OUTDOOR					
140748-010-12	10	70	17 - 41		2
316		Poli miroir			
OUTDOOR					
140748-010-10	10	70	17 - 41		2

MOD 0748

304		Inox brossé			
INDOOR	H	L	L1		
130748-030-12	30	90	17 - 41		2
130748-040-12	40	100	17 - 41		2
304		Poli miroir			
INDOOR					
130748-050-10	50	110	17 - 41		2
316		Inox brossé			
OUTDOOR					
140748-030-12	30	90	17 - 41		2
140748-040-12	40	100	17 - 41		2

SELL OUT



Q-INFO

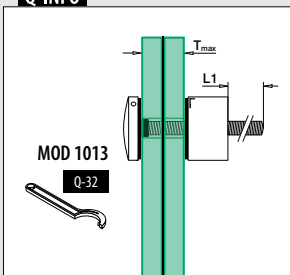

Q-INFO | MOD 0745-010

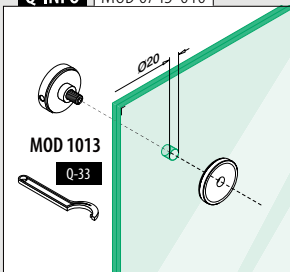

Q-INFO | MOD 0745-030 / 050

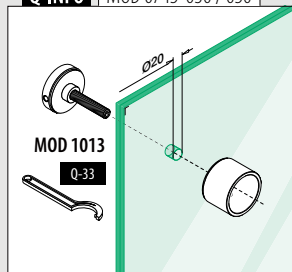

Q-INFO | MOD 0748-010

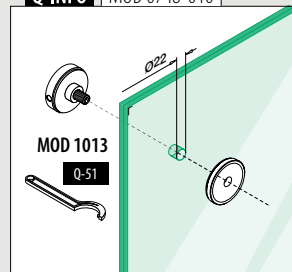

Q-INFO | MOD 0748-030 / 040 / 050

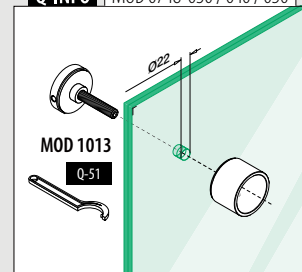

Adaptateurs à verre

Adaptateurs à verre double

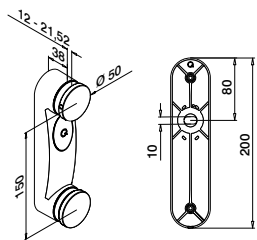

MOD 0762

304 Inox brossé

INDOOR		
130762-12	457 - 463	1

316 Inox brossé

OUTDOOR		
140762-12	457 - 463	1



International Design Modèle Protection

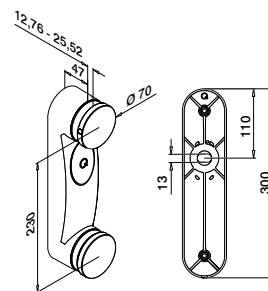

MOD 0760

304 Inox brossé

INDOOR		
130760	457 - 463	1



International Design Modèle Protection

Adaptateurs à verre

Adaptateurs à verre double

Angle ajustable

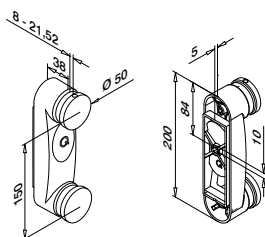

MOD 0766

304 Inox brossé

INDOOR		
130766	457 - 463	1



International Design Modèle Protection

Q-INFO MOD 0766

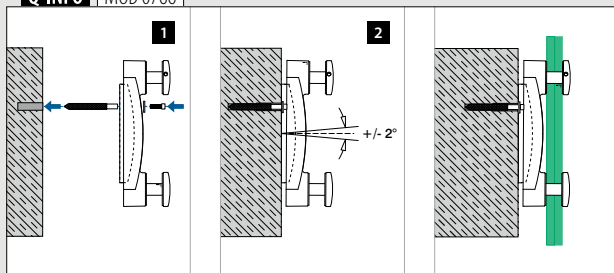

Q-INFO MOD 0762 / 0760

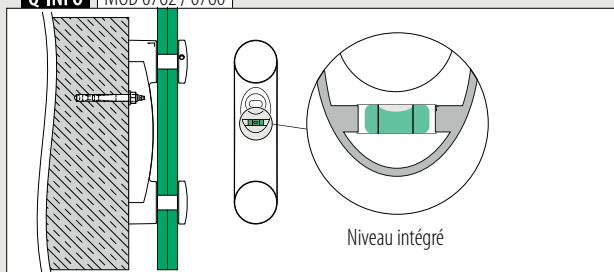

Seulement jusqu'à épuisement des stocks.

Q-INFO MOD 0762 / 0766

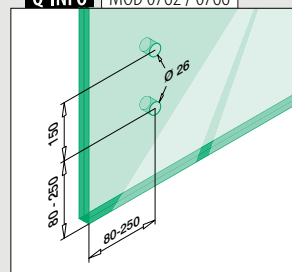

Q-INFO MOD 0760

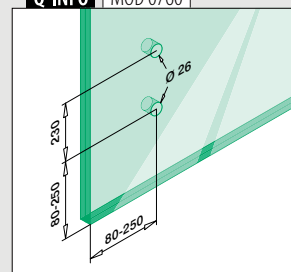



MOD 0760

Q-railing

Adaptateurs à verre

Adaptateurs à verre

Carré

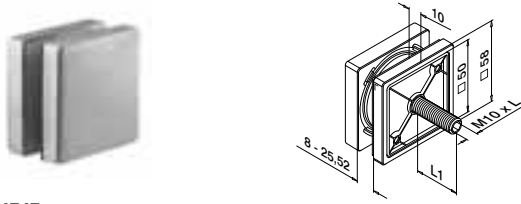

MOD 4747

316	Inox brossé			
OUTDOOR	L	L1		
144747-010-12	60	13 - 31	2	



International Design Modèle Protection

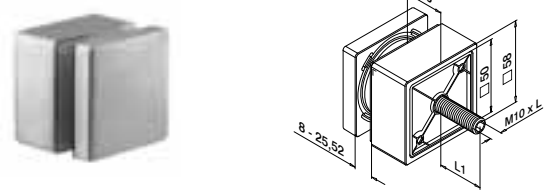

MOD 4747

316	Inox brossé			
OUTDOOR	L	L1		
144747-030-12	80	13 - 31	2	



International Design Modèle Protection

Adaptateurs à verre

Adaptateurs à verre double

Rectangulaire

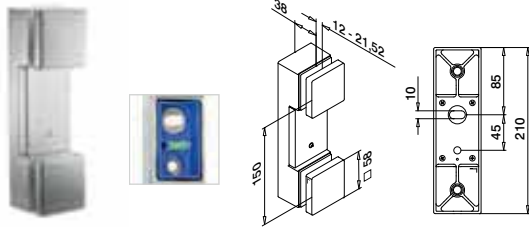

MOD 4762

316	Inox brossé			
OUTDOOR				
144762-12	457 - 463	1		



International Design Modèle Protection

Q-INFO 316

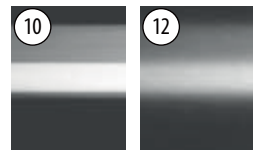

Poli miroir Inox brossé

SELL OUT Seulement jusqu'à épuisement des stocks.

Q-INFO MOD 4762

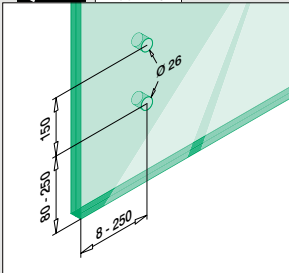

Q-INFO MOD 4747

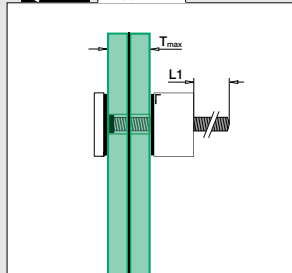

Q-INFO MOD 4747

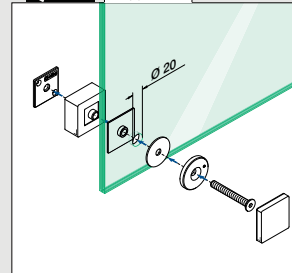

Q-INFO MOD 4747

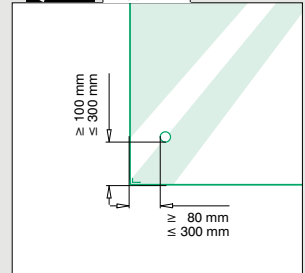

Q-INFO MOD 4762

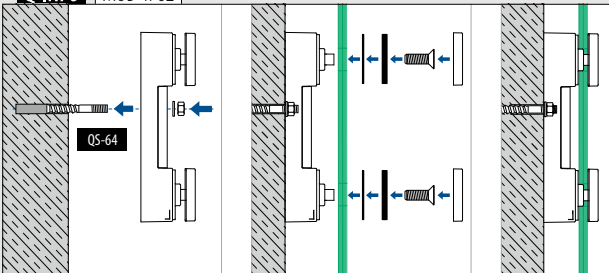

Q-INFO MOD 4762

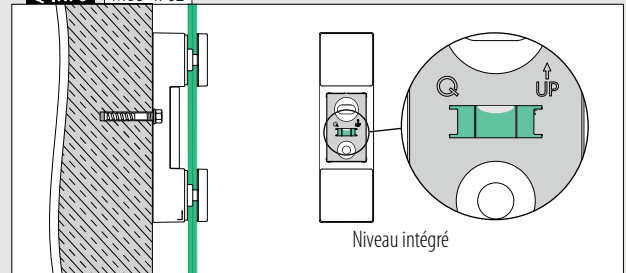

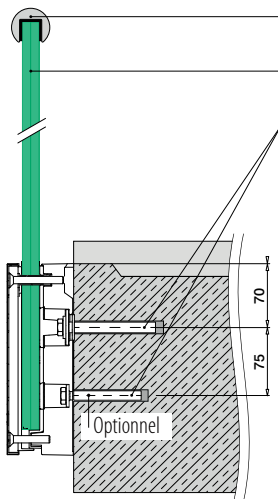

Optionnel :
 Tubes à fond de gorge : ■ 169 - 185
 Profilé de main courante Edge : ■ 166 - 168
 Verre de sécurité : ■ 160 - 161
 Fixations : ■ 457 - 463

Merci de prendre en considération les spécifications de chaque certificat telles qu'épaisseur du verre, fixation et types de verre.

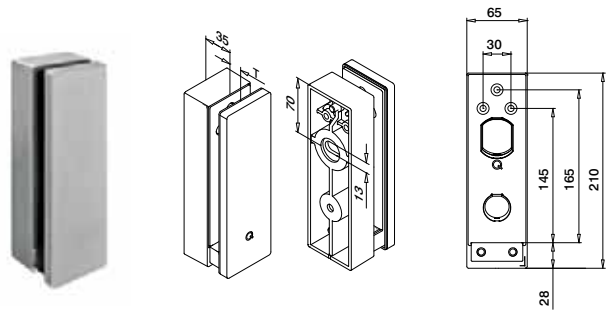

MOD 0763

304	Inox brossé		
INDOOR	T		
130763-12	12 - 21,52	■ 457 - 463	1
316	Inox brossé		
OUTDOOR			
140763-12	12 - 21,52	■ 457 - 463	1



International Design Modèle Protection

Q-INFO

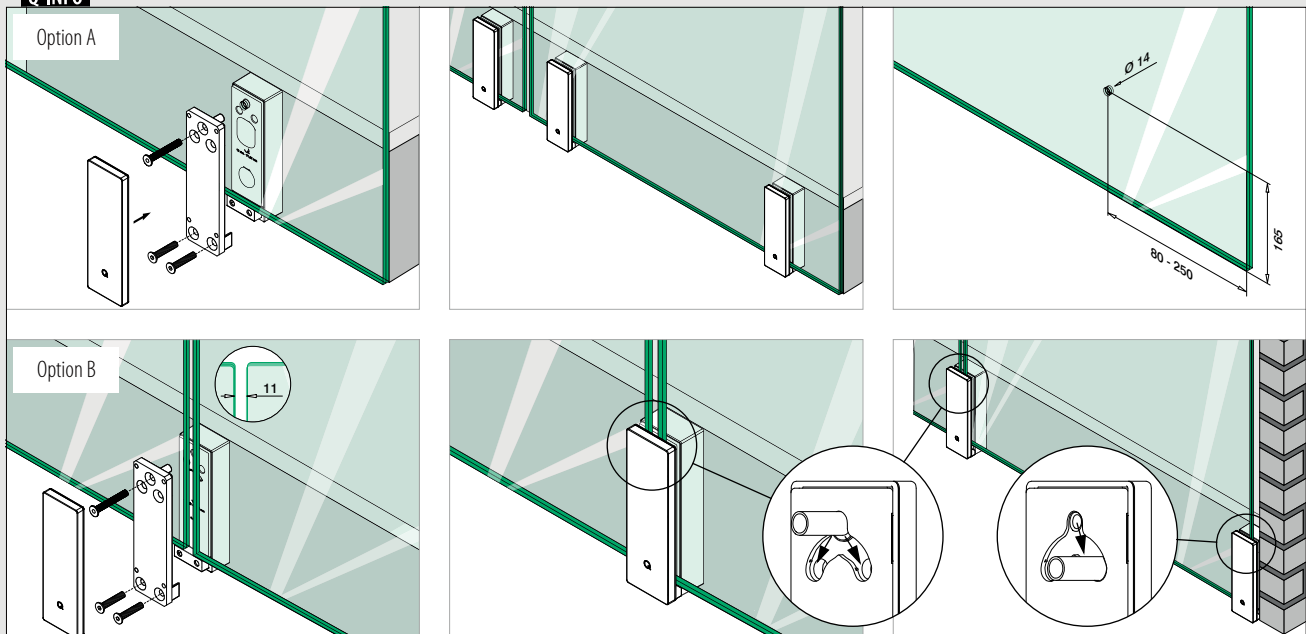



Q-GLASS

VERRE POUR GARDE-CORPS TOUT EN VERRE

Profitez de la commande de votre garde-corps pour acheter vos remplissages en verre

Verre sur-mesure

- Du verre monolithique au verre feuilleté trempé de 31,52 mm d'épaisseur
- Verre de couleur ou verre laminé SentryGlas® en option
- Coins arrondis et rebords polis sur demande
- Pré-percé en option
- Traitement Heat Soak Test possible

Panneau de verre standard

- Disponible rapidement
- Verre feuilleté trempé
- 8,76 - 16,76 mm, 10 largeurs et 3 hauteurs
- Bords lisses, arrondis et polis
- Coins arrondis

■ Marqués CE ■ Grande qualité ■ Livraison rapide ■ Prix compétitifs clairement indiqués ■ Facile à commander

Q-GLASS (Verre de sécurité)

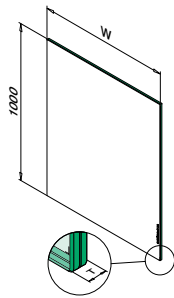

MOD 5017

Verre de sécurité Feuilleté

OUTDOOR	W	T
195017-040-10	400	16,76
195017-050-10	500	16,76
195017-060-10	600	16,76
195017-070-10	700	16,76
195017-080-10	800	16,76
195017-090-10	900	16,76
195017-095-10	950	16,76
195017-100-10	1000	16,76
195017-100-11	1100	16,76
195017-100-12	1200	16,76

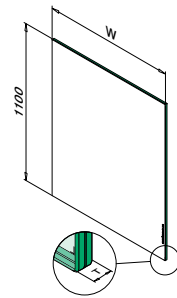

MOD 5017

Verre de sécurité Feuilleté

OUTDOOR	W	T
195017-040-11	400	16,76
195017-050-11	500	16,76
195017-060-11	600	16,76
195017-070-11	700	16,76
195017-080-11	800	16,76
195017-090-11	900	16,76
195017-095-11	950	16,76
195017-100-11	1000	16,76

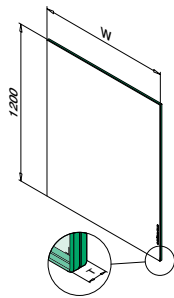

MOD 5017

Verre de sécurité Feuilleté

OUTDOOR	W	T
195017-040-12	400	16,76
195017-050-12	500	16,76
195017-060-12	600	16,76
195017-070-12	700	16,76
195017-080-12	800	16,76
195017-090-12	900	16,76
195017-095-12	950	16,76
195017-100-12	1000	16,76



Seulement jusqu'à épuisement des stocks.

Q-INFO

Calcul

$$H \text{ (m)} \times W \text{ (m)} \times 2,5 \times T_g \text{ (mm)} = \text{kg}$$

Exemple

H	W	T
1,1 m	1,0 m	16 mm
$1,1 \times 1,0 \times 2,5 \times 16 = 44,00 \text{ kg}$		

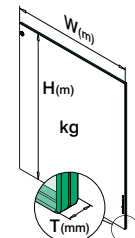

Q-INFO

Verre feuilleté de sécurité

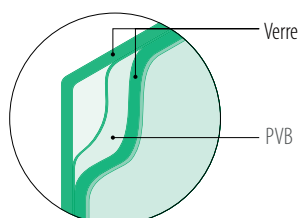
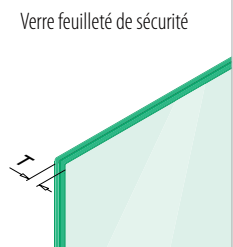

Bord lisse



Coins arrondis



Bord arrondi



Bord poli

Remplissage

Pinces de liaison

Ø 50

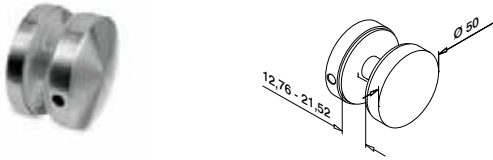

MOD 0742

304	Inox brossé	
INDOOR		
130742-12		2
316	Inox brossé	
OUTDOOR		
140742-12		2
316	Poli miroir	
OUTDOOR		
140742-10		2



Remplissage

Cales caoutchouc pour MOD 2870 / 2890



4 pièces par pince de liaison

MOD 5028

Accessoires		
Pour verre feuilleté	T	
205028-17	16,76	8
205028-18	17,52	8
205028-21	20,76	8
205028-22	21,52	8



MOD 2870, 2880, 2890
Pour T = 6 - 12,76 mm
446

Remplissage

Pinces de liaison - pour épaisseur de verre 16,76 - 21,52 mm

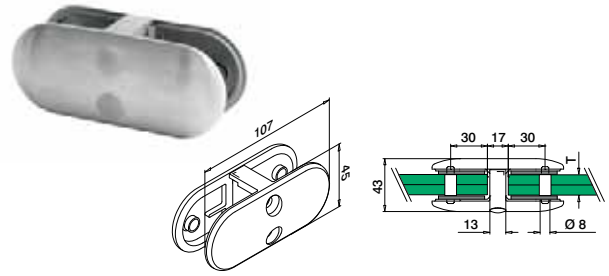

MOD 2870

316	Inox brossé	
OUTDOOR		
142870-22-12	Voir T en MOD 5028	2



International Design Modèle Protection



MOD 2890

316	Inox brossé	
OUTDOOR		
142890-22-12	Voir T en MOD 5028	2



International Design Modèle Protection

Accessoires

Goupilles de sécurité

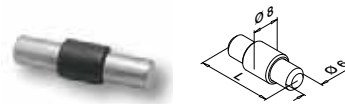

Optionnel pour MOD 2870 / 2890

MOD 5015

Accessoires		
	L	
205015-24	30	4

Q-INFO 316

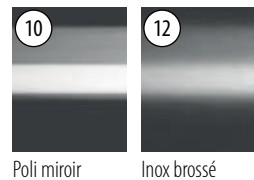

Q-INFO MOD 0742

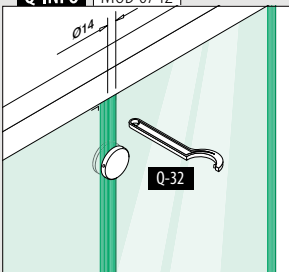

Q-INFO MOD 2870

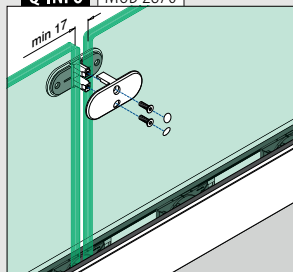

Q-INFO MOD 2890

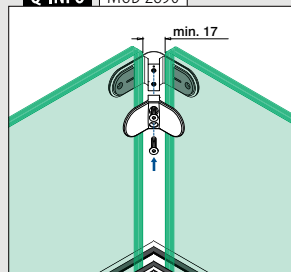

Q-INFO MOD 2870 / 2890

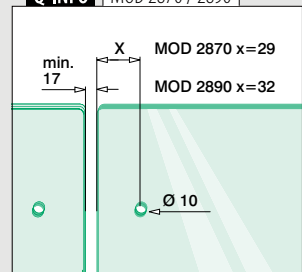

Pincés de liaison - pour épaisseur de verre 16,76 - 21,52 mm

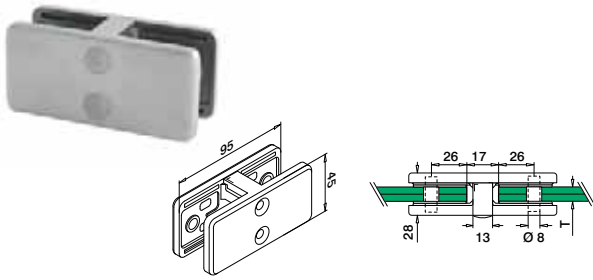
**MOD 4270**

316 Inox brossé

OUTDOOR**T**

144270-22-12

Voir T en MOD 5042

2

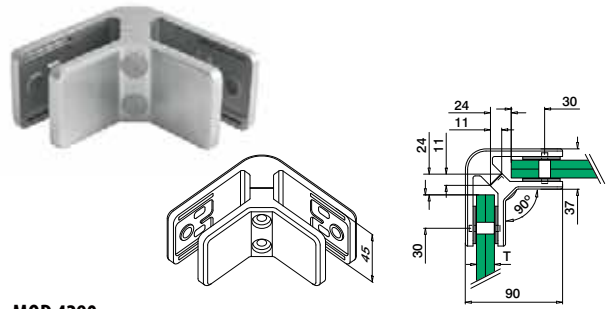

International Design Modèle Protection

**MOD 4290**

316 Inox brossé

OUTDOOR**T**

144290-22-12

Voir T en MOD 5042

2



International Design Modèle Protection

Cales caoutchouc pour MOD 4270 / 4290

4 pièces par
pince de liaison**MOD 5042**

Accessoires

Pour verre feuilleté

T

205042-17

16,76

8

205042-18

17,52

8

205042-21

20,76

8

205042-22

21,52

8

Goupilles de sécurité

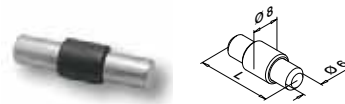
Optionnel pour
MOD 4270 / 4290**MOD 5015**

Accessoires

L

205015-24

30

4

**MOD 4270, 4280, 4290**

Pour T = 6 - 12,76 mm

447

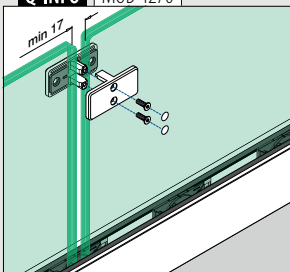
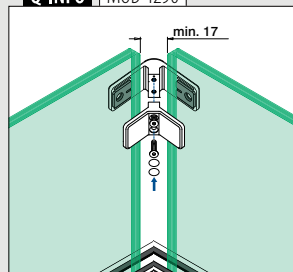
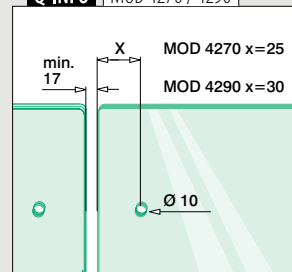
Q-INFO MOD 4270**Q-INFO** MOD 4290**Q-INFO** MOD 4270 / 4290

Accessoires

Pinces de liaison

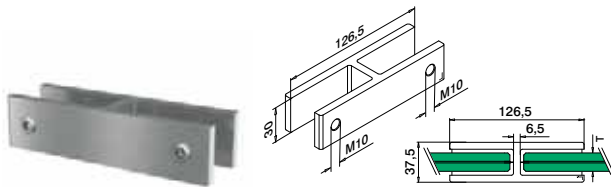

MOD 0291

Aluminium Broissé, anodisé

OUTDOOR

	T	
160291-22-18	Voir T en MOD 5092	2

NEW

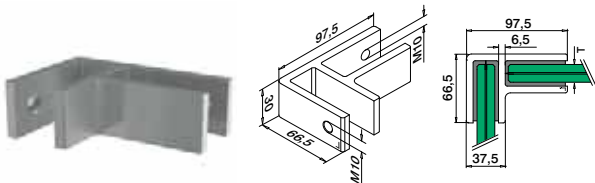

MOD 0292

Aluminium Broissé, anodisé

OUTDOOR

	T	
160292-22-18	Voir T en MOD 5092	2

NEW

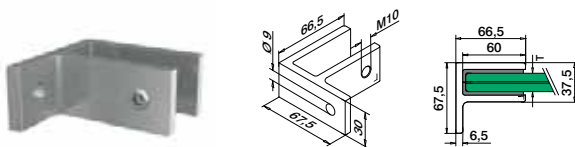

MOD 0293

Aluminium Broissé, anodisé

OUTDOOR

	T	
160293-22-18	Voir T en MOD 5092	2

NEW

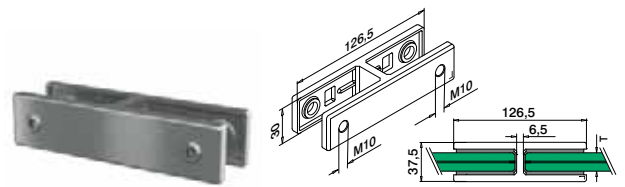

MOD 0291

316 Inox broissé

OUTDOOR

	T	
140291-22-12	Voir T en MOD 5091	2

NEW

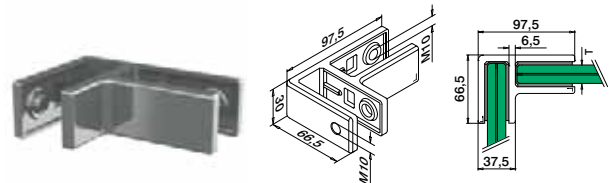

MOD 0292

316 Inox broissé

OUTDOOR

	T	
140292-22-12	Voir T en MOD 5091	2

NEW

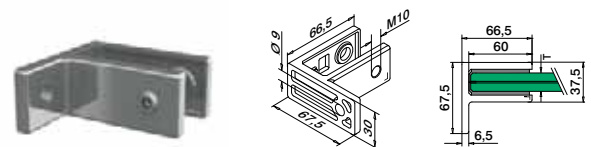

MOD 0293

316 Inox broissé

OUTDOOR

	T	
140293-22-12	Voir T en MOD 5091	2

NEW

Remplissage

Cales caoutchouc pour MOD 0291 / 0292 / 0293 (aluminium)



4 pièces pour MOD 0291 et 0292
2 pièces pour MOD 0293
Vis de fixation du verre incluses

MOD 5092

Accessoires

Pour verre feuilleté	T	
205092-18	16,76 + 17,52	4
205092-22	20,76 + 21,52	4

NEW

Remplissage

Cales caoutchouc pour MOD 0291 / 0292 / 0293 (acier inoxydable)



4 pièces pour MOD 0291 et 0292
2 pièces pour MOD 0293
Vis de fixation du verre incluses

MOD 5091

Accessoires

Pour verre feuilleté	T	
205091-18	16,76 + 17,52	4
205091-22	20,76 + 21,52	4

NEW

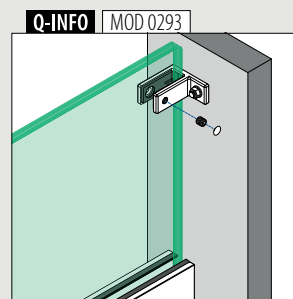
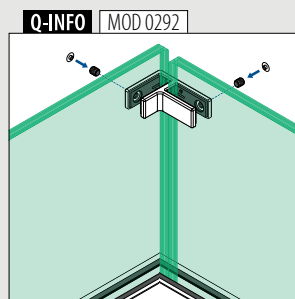
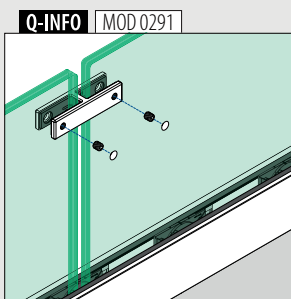



PROFILÉ
DE MAIN
COURANTE
EDGE

▣ 166

PROFILÉ EN
U DE MAIN
COURANTE
EDGE

▣ 167, 168

TUBES À FOND
DE GORGE
carrés /
rectangulaires

▣ 176



TUBES À FOND
DE GORGE
ronds

▣ 169

Q-railing

Profilé de main courante Edge

Profilé de main courante Edge

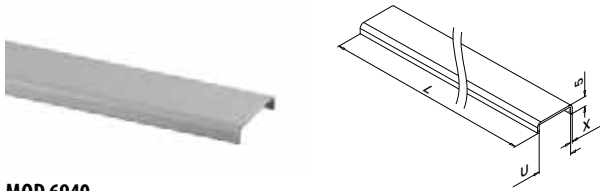

MOD 6940

	Aluminium Brut				
	U	Q	X	T	Icon
166940-050-18-00	18,5	Q-98	1,5	16,76 - 17,52	L = 5 m
Aluminium Broissé, anodisé					
OUTDOOR					
166940-025-18-18	18,5	Q-98	1,5	16,76 - 17,52	L = 2,5 m
166940-025-22-18	22,5	Q-99	1,5	20,76 - 21,52	L = 2,5 m
166940-050-18-18	18,5	Q-98	1,5	16,76 - 17,52	L = 5 m
166940-050-22-18	22,5	Q-99	1,5	20,76 - 21,52	L = 5 m
Aluminium Black Line					
OUTDOOR					
166940-025-18-82	18,5	Q-98	1,5	16,76 - 17,52	L = 2,5 m



Profilé de main courante Edge

Angles

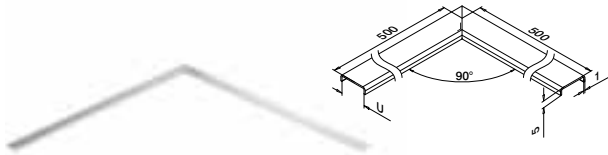

MOD 6340

	316 Inox broissé		
	U	T	Icon
146340-500-18	18,5	16,76 - 17,52	1
146340-500-22	22,5	20,76 - 21,52	1
146340-500-26	26,5	24,76 - 25,52	1

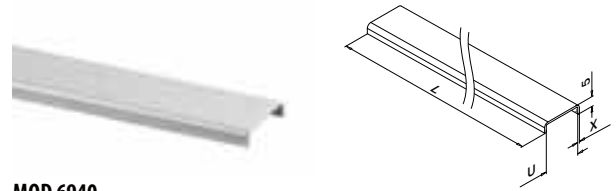

MOD 6940

	316 Inox broissé				
	U	Q	X	T	Icon
OUTDOOR					
146940-025-18-12	18,5	Q-98	1	16,76 - 17,52	L = 2,5 m
146940-025-22-12	22,5	Q-99	1	20,76 - 21,52	L = 2,5 m
146940-050-14-12	14,5	Q-111	1	12,76 - 13,52	L = 5 m
146940-050-18-12	18,5	Q-98	1	16,76 - 17,52	L = 5 m
146940-050-22-12	22,5	Q-99	1	20,76 - 21,52	L = 5 m
146940-050-26-12	26,5	Q-112	1	24,76 - 25,52	L = 5 m

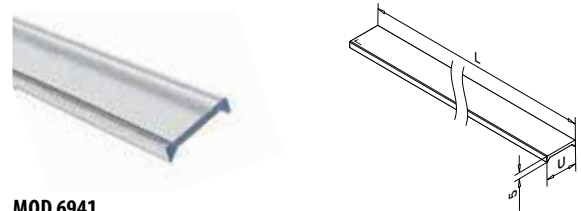

MOD 6941

	Plastique Transparent			
	U	Q	T	
INDOOR				
156941-025-18-03	18,5	Q-122	16,76 - 17,52	L = 2,5 m

NEW

Q-INFO Aluminium MOD 6940

00 Brut	18 Broissé, anodisé	82 RAL 9005 Noir, mat, texture Thermolaqué
-------------------	-------------------------------	---------------------------------------------------------

Q-INFO

1 Q-98, Q-99, Q-111, Q-112

2

Q-INFO MOD 6940

Q-INFO 316 MOD 6340 / 6940

*MOD 6940

Q-INFO

1 Q-98, Q-112, Q-99, Q-122, Q-111

2

Q-121 MOD 1040

Profilé en U de main courante Edge

Carré □

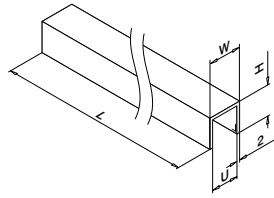

MOD 6944

Aluminium **Brossé, anodisé**

OUTDOOR	U	Q	T	W	H	
166944-050-13-18	13,25	Q-111	12,76	17,25	15	L = 5 m
166944-050-18-18	18	Q-98	16,76 - 17,52	22	20	L = 5 m
166944-050-22-18	22	Q-99	21,52	26	20	L = 5 m

Aluminium **Black Line**

OUTDOOR	U	Q	T	W	H	
166944-050-13-82	13,25	Q-111	12,76	17,25	15	L = 5 m
166944-050-18-82	18	Q-98	16,76 - 17,52	22	20	L = 5 m
166944-050-22-82	22	Q-99	21,52	26	20	L = 5 m

NEW
NEW
NEW



Profils en U

Carré □

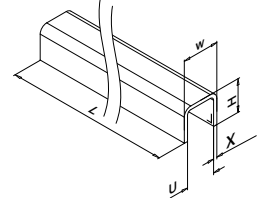

MOD 6960

304 **Inox brossé**

INDOOR	U	X	T	W	H	
136960-050-24-12	24	3	8 - 21,52	30	27	L = 5 m

316 **Inox brossé**

OUTDOOR	U	X	T	W	H	
146960-050-24-12	24	3	8 - 21,52	30	27	L = 5 m
146960-050-34-12	34	3	8 - 31,52	40	37	L = 5 m

316 **Black Line**

OUTDOOR	U	X	T	W	H	
146960-050-24-82	24	3	8 - 21,52	30	27	L = 5 m

NEW

MOD 6961

304 **Inox brossé**

INDOOR	U	X	T	W	H	
136961-050-24-12	24	2	8 - 21,52	28	26	L = 5 m

316 **Inox brossé**

OUTDOOR	U	X	T	W	H	
146961-050-24-12	24	2	8 - 21,52	28	26	L = 5 m
146961-050-34-12	34	2	8 - 31,52	38	36	L = 5 m



Q-INFO MOD 6944

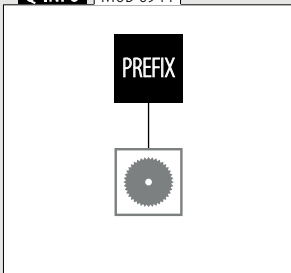

Q-INFO Aluminium



Q-INFO MOD 6960 / 6961

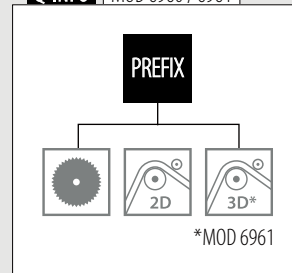

Q-INFO 304 316



Q-INFO

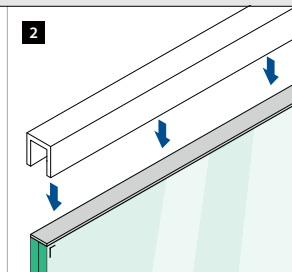
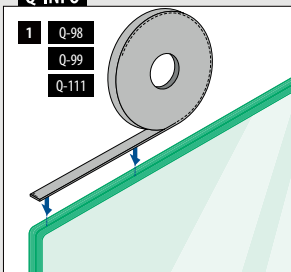

Q-INFO MOD 6960 / 6961

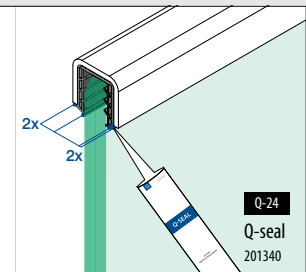
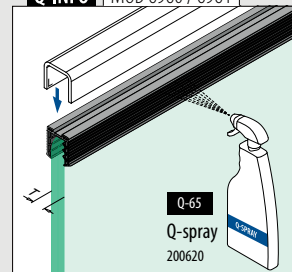

Profil en U

Angles

Carré □



MOD 6362

316		Inox brossé					
OUTDOOR	U	X	T	W	H	☐	
146362-24-12	24	3	8 - 21,52	30	27	1	
146362-34-12	34	3	8 - 31,52	40	37	1	
316		Black Line					
OUTDOOR	U	X	T	W	H	☐	
NEW 146362-24-82	24	3	8 - 21,52	30	27	1	

MOD 6361

316		Inox brossé					
OUTDOOR	U	X	T	W	H	☐	
146361-24	24	2	8 - 21,52	28	26	1	
146361-34	34	2	8 - 31,52	38	36	1	

Profil en U

Embouts

Carré □

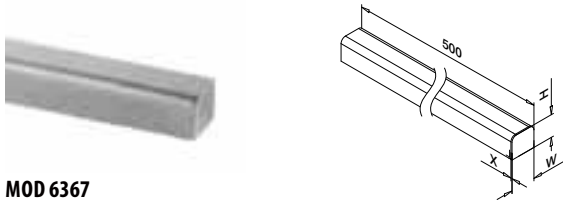

MOD 6367

316		Inox brossé					
OUTDOOR	U	X	T	W	H	☐	
146367-24-12	24	3	8 - 21,52	30	27	1	
146367-34-12	34	3	8 - 31,52	40	37	1	
316		Black Line					
OUTDOOR	U	X	T	W	H	☐	
NEW 146367-24-82	24	3	8 - 21,52	30	27	1	

MOD 6366

316		Inox brossé					
OUTDOOR	U	X	T	W	H	☐	
146366-24	24	2	8 - 21,52	28	26	1	
146366-34	34	2	8 - 31,52	38	36	1	

Profil en U

Joint pour fond de gorge



MOD 5124

Accessoires		
U = 24 mm		
Pour verre monolithique	T	☐
205124-050-08	8 - 10	L = 5 m
205124-050-11	12	L = 5 m
205124-050-15	15	L = 5 m
205124-050-19	19	L = 5 m

Pour verre feuilleté		
205124-050-08	8,76 - 10,76	L = 5 m
205124-050-11	11,52 - 13,52	L = 5 m
205124-050-17	16,76 - 17,52	L = 5 m
NEW 205124-050-92	20,76 - 21,52	L = 5 m

MOD 5134

Accessoires		
U = 34 mm		
Pour verre monolithique	T	☐
205134-050-08	8 - 10	L = 5 m
205134-050-11	12	L = 5 m
205134-050-19	19	L = 5 m

Pour verre feuilleté		
205134-050-08	8,76 - 10,76	L = 5 m
205134-050-11	11,52 - 13,52	L = 5 m
205134-050-17	16,76 - 17,52	L = 5 m
205134-050-22	20,76 - 21,52	L = 5 m
205134-050-24	24,76 - 25,52	L = 5 m
205134-050-32	31,52	L = 5 m

Q-INFO 304 316

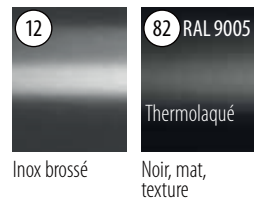

Q-INFO MOD 6366 / 6367

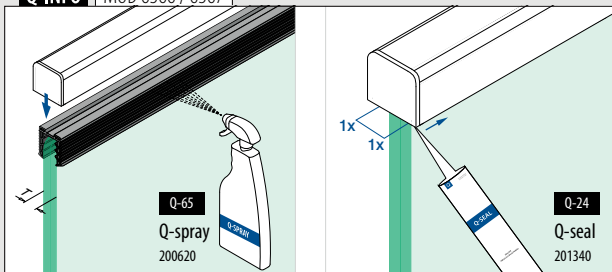

Q-INFO MOD 6361 / 6362

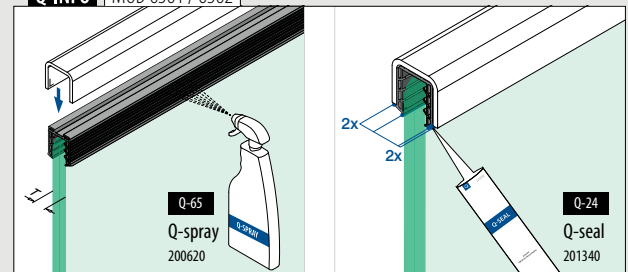

Tubes à fond de gorge

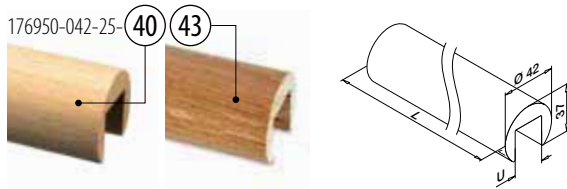

MOD 6950

Hêtre		Naturel verni	
INDOOR	U		
176950-042-25-40	24		L = 2,5 m
Chêne		Naturel verni	
INDOOR			
176950-042-25-43	24		L = 2,5 m

PREFIX

Raccords



MOD 6791

304		Inox brossé	
INDOOR	Ø		
176791-042	42,0	QS-49 471	2



Embouts



MOD 6729

304		Inox brossé	
INDOOR			
176729-042	QS-49 471		2



Le bois est un produit naturel; des variations de couleur sont possibles.

Joints pour fond de gorge



MOD 5124

Accessoires		
U = 24 mm		
Pour verre monolithique		T
205124-050-08	8 - 10	L = 5 m
205124-050-11	12	L = 5 m
205124-050-15	15	L = 5 m
205124-050-19	19	L = 5 m
Pour verre feuilleté		
205124-050-08	8,76 - 10,76	L = 5 m
205124-050-11	11,52 - 13,52	L = 5 m
205124-050-17	16,76 - 17,52	L = 5 m
NEW 205124-050-92	20,76 - 21,52	L = 5 m

Gabarit de perçage



MOD 1024

Accessoires		
	Q	
201024-042	Q-20	1

Q-INFO MOD 6950



Q-INFO MOD 6950

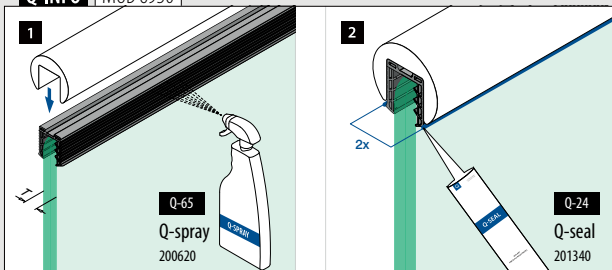

Q-INFO MOD 6729 / 1024

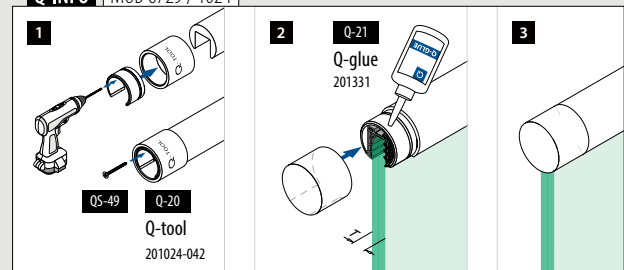

Mains-courantes

Tubes à fond de gorge

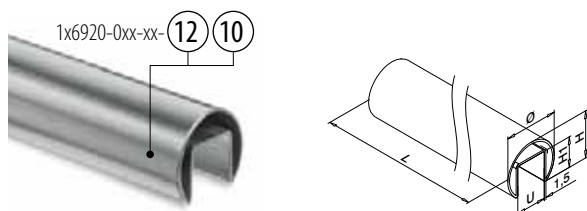

MOD 6920

Ø 42,4 mm

304		Inox brossé		
INDOOR	U	H	H1	
136920-042-25-12	24	37	24	L = 2,5 m
136920-042-50-12	24	37	24	L = 5 m

SELL
OUT

316		Inox brossé		
OUTDOOR	U	H	H1	
146920-042-50-12	24	37	24	L = 5 m

316		Poli miroir		
OUTDOOR	U	H	H1	
146920-042-50-10	24	37	24	L = 5 m

Ø 48,3 mm

304		Inox brossé		
INDOOR	U	H	H1	
136920-048-50-12	27	42,6	30	L = 5 m

316		Inox brossé		
OUTDOOR	U	H	H1	
146920-048-50-12	27	42,6	30	L = 5 m

Ø 60,3 mm

304		Inox brossé		
INDOOR	U	H	H1	
136920-060-50-12	34	53	34	L = 5 m

316		Inox brossé		
OUTDOOR	U	H	H1	
146920-060-50-12	34	53	34	L = 5 m



Mains-courantes

Joint pour fond de gorge



MOD 5124

Accessoires

U = 24 mm

Pour verre monolithique	T	
205124-050-08	8 - 10	L = 5 m
205124-050-11	12	L = 5 m
205124-050-15	15	L = 5 m
205124-050-19	19	L = 5 m

205124-250-08	8 - 10	L = 25 m
205124-250-11	12	L = 25 m
205124-250-15	15	L = 25 m
205124-250-19	19	L = 25 m

Pour verre feuilleté

205124-050-08	8,76 - 10,76	L = 5 m
205124-050-11	11,52 - 13,52	L = 5 m
205124-050-17	16,76 - 17,52	L = 5 m
NEW 205124-050-92	20,76 - 21,52	L = 5 m

205124-250-08	8,76 - 10,76	L = 25 m
205124-250-11	11,52 - 13,52	L = 25 m
205124-250-17	16,76 - 17,52	L = 25 m
NEW 205124-250-92	20,76 - 21,52	L = 25 m

MOD 5127

Accessoires

U = 27 mm

Pour verre monolithique	T	
205127-050-08	8 - 10	L = 5 m
205127-050-11	12	L = 5 m
205127-050-15	15	L = 5 m
205127-050-19	19	L = 5 m

Pour verre feuilleté

205127-050-08	8,76 - 10,76	L = 5 m
205127-050-11	11,52 - 13,52	L = 5 m
205127-050-15	16,76 - 17,52	L = 5 m
205127-050-22	20,76 - 21,52	L = 5 m
205127-050-24	24,76 - 25,52	L = 5 m

MOD 5134

Accessoires

U = 34 mm

Pour verre monolithique	T	
205134-050-08	8 - 10	L = 5 m
205134-050-11	12	L = 5 m
205134-050-19	15	L = 5 m

Pour verre feuilleté

205134-050-08	8,76 - 10,76	L = 5 m
205134-050-11	11,52 - 13,52	L = 5 m
205134-050-17	16,76 - 17,52	L = 5 m
205134-050-22	20,76 - 21,52	L = 5 m
205134-050-24	24,76 - 25,52	L = 5 m
205134-050-32	31,52	L = 5 m

Q-INFO MOD 6920

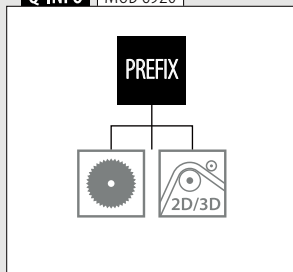

Q-INFO 316



SELL
OUT Seulement jusqu'à épuisement des stocks.

Raccords

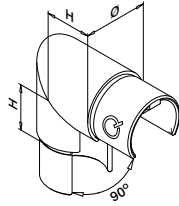

MOD 6303

304		Inox brossé		
INDOOR	Ø	H		
136303-042-12	42,4 x 1,5	30	2	
316		Inox brossé		
OUTDOOR	Ø	H		
146303-042-12	42,4 x 1,5	30	2	

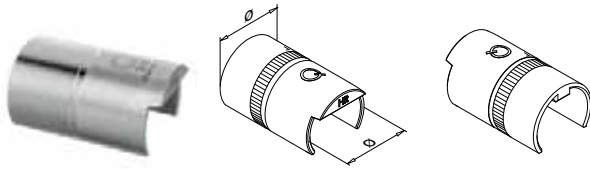

MOD 6792 - EASY HIT®

304		Brut	
INDOOR	Pour tube Ø		
136792-042	42,4 x 1,5	2	
136792-048	48,3 x 1,5	2	
316		Brut	
OUTDOOR	Pour tube Ø		
146792-042	42,4 x 1,5	2	
146792-048	48,3 x 1,5	2	
146792-060	60,3 x 1,5	2	

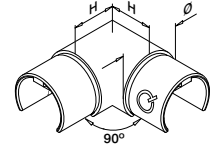

MOD 6313

304		Inox brossé		
INDOOR	Ø	H		
136313-042-12	42,4 x 1,5	30	2	
136313-048-12	48,3 x 1,5	35	2	
136313-060-12	60,3 x 1,5	40	2	
316		Inox brossé		
OUTDOOR	Ø	H		
146313-042-12	42,4 x 1,5	30	2	
146313-048-12	48,3 x 1,5	35	2	
146313-060-12	60,3 x 1,5	40	2	
316		Poli miroir		
OUTDOOR	Ø	H		
146313-042-10	42,4 x 1,5	30	2	

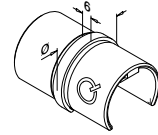

MOD 6790

304		Inox brossé	
INDOOR	Pour tube Ø		
136790-042-12	42,4 x 1,5	2	
136790-048-12	48,3 x 1,5	2	
136790-060-12	60,3 x 1,5	2	
316		Inox brossé	
OUTDOOR	Pour tube Ø		
146790-042-12	42,4 x 1,5	2	
146790-048-12	48,3 x 1,5	2	
316		Poli miroir	
OUTDOOR	Pour tube Ø		
146790-042-10	42,4 x 1,5	2	



Q-INFO | MOD 6792

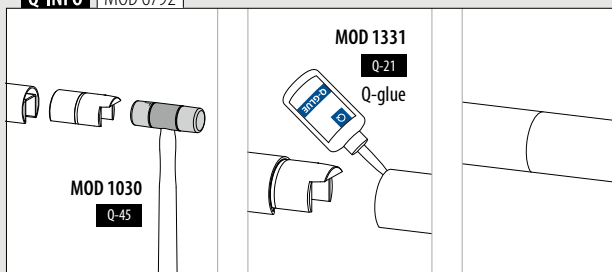



MOD 6302

304 Inox brossé			
INDOOR	Ø	H	📦
136302-042-02-12	42,4 x 1,5	30	2
136302-048-02-12	48,3 x 1,5	35	2
136302-060-02-12	60,3 x 1,5	40	2

MOD 6302

304 Inox brossé			
INDOOR	Ø	H	📦
136302-042-01-12	42,4 x 1,5	30	2
136302-048-01-12	48,3 x 1,5	35	2
136302-060-01-12	60,3 x 1,5	40	2

SELL OUT

SELL OUT

316 Inox brossé			
OUTDOOR	Ø	H	📦
146302-042-02-12	42,4 x 1,5	30	2
146302-048-02-12	48,3 x 1,5	35	2
146302-060-02-12	60,3 x 1,5	40	2

316 Inox brossé			
OUTDOOR	Ø	H	📦
146302-042-01-12	42,4 x 1,5	30	2
146302-048-01-12	48,3 x 1,5	35	2
146302-060-01-12	60,3 x 1,5	40	2

316 Poli miroir			
OUTDOOR	Ø	H	📦
146302-042-02-10	42,4 x 1,5	30	2

316 Poli miroir			
OUTDOOR	Ø	H	📦
146302-042-01-10	42,4 x 1,5	30	2

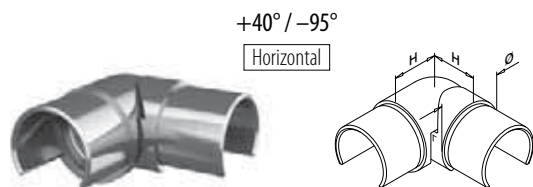

MOD 6312

304 Inox brossé			
INDOOR	Ø	H	📦
136312-042-12	42,4 x 1,5	27	2
136312-048-12	48,3 x 1,5	30	2

316 Inox brossé			
OUTDOOR	Ø	H	📦
146312-042-12	42,4 x 1,5	27	2
146312-048-12	48,3 x 1,5	30	2

NEW



Q-INFO 316

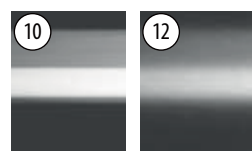

Poli miroir Inox brossé

SELL OUT

Seulement jusqu'à épuisement des stocks.

Raccord pour fond de gorge à tube

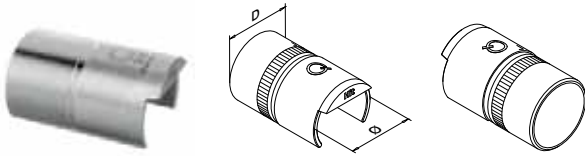

MOD 5793 - EASY HIT®

316	Brut			
OUTDOOR	Pour tube D	Pour tube Ø		
145793-042	42,4 x 2,0	42,4 x 1,5		2
145793-048	48,3 x 2,0	48,3 x 1,5		2



International Design Modèle Protection

Emboutis croisés



MOD 6738

304	Inox brossé			
INDOOR	Pour tube Ø	L		
136738-042-12	42,4 x 1,5	60		2
136738-048-12	48,3 x 1,5	65		2

316	Inox brossé			
OUTDOOR				
146738-042-12	42,4 x 1,5	60		2



International Design Modèle Protection

Emboutis



MOD 6732

304	Inox brossé			
INDOOR	Pour tube Ø			
136732-042-12	42,4 x 1,5			2
136732-048-12	48,3 x 1,5			2
136732-060-12	60,3 x 1,5			2

316	Inox brossé			
OUTDOOR				
146732-042-12	42,4 x 1,5			2
146732-048-12	48,3 x 1,5			2
146732-060-12	60,3 x 1,5			2

316	Poli miroir			
OUTDOOR				
146732-042-10	42,4 x 1,5			2

SELL OUT



Embases murales pour tube

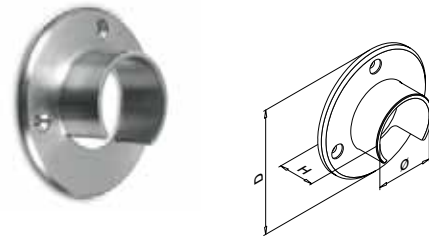

MOD 6505

304	Inox brossé					
INDOOR	Pour Ø	D	H			
136505-042-12	42,4	90	30	Q5-5	471	2
136505-048-12	48,3	95	35	Q5-5	471	2
136505-060-12	60,3	107	35	Q5-5	471	2

316	Inox brossé					
OUTDOOR						
146505-042-12	42,4	90	30	Q5-6	471	2
146505-048-12	48,3	95	35	Q5-6	471	2
146505-060-12	60,3	107	35	Q5-6	471	2

316	Poli miroir					
OUTDOOR						
146505-042-10	42,4	90	30	Q5-6	471	2

SELL OUT



Q-INFO MOD 6738

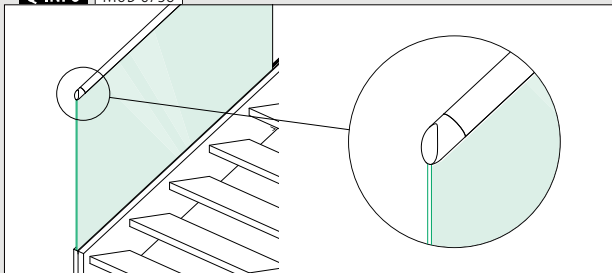

Q-INFO MOD 5793

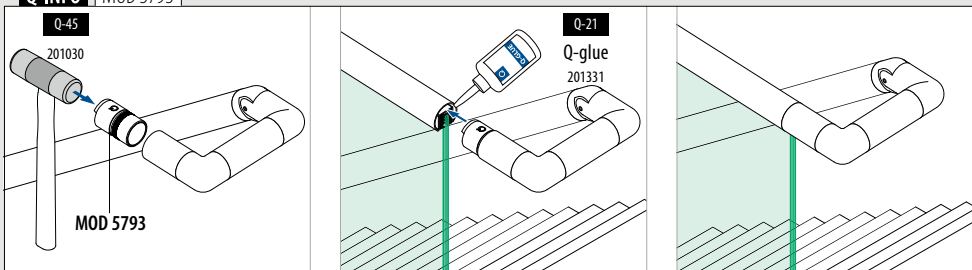

Mains-courantes

Tubes à fond de gorge

166920-042-50-00 18

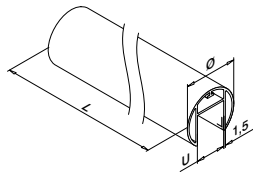

MOD 6920

Aluminium	Brut	U	Ø	
166920-042-50-00		24	42,4	L = 5 m
Aluminium	Brossé, anodisé			
OUTDOOR				
166920-042-50-18		24	42,4	L = 5 m



International Design Modèle Protection

Mains-courantes

Angles

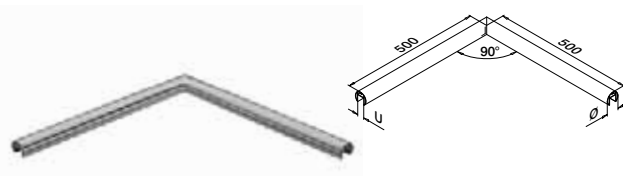

MOD 6320

Aluminium	Brut	U	Ø	
166320-042-00		24	42,4 x 1,5	1
Aluminium	Brossé, anodisé			
OUTDOOR				
166320-042-18		24	42,4 x 1,5	1

International Design Modèle Protection

Mains-courantes

Embouts

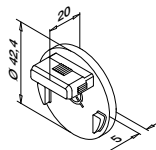

MOD 6732 - EASY HIT®

Aluminium	Brut	Pour Ø	
166732-042-00		42,4 x 1,5	2
Aluminium	Brossé, anodisé		
OUTDOOR			
166732-042-18		42,4 x 1,5	2



International Design Modèle Protection

Mains-courantes

Joint pour fond de gorge

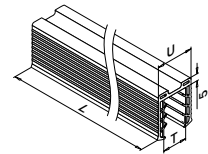

MOD 5124

Accessoires

U = 24 mm

Pour verre monolithique	T	
205124-050-08	8 - 10	L = 5 m
205124-050-11	12	L = 5 m
205124-050-15	15	L = 5 m
205124-050-19	19	L = 5 m
205124-250-08	8 - 10	L = 25 m
205124-250-11	12	L = 25 m
205124-250-15	15	L = 25 m
205124-250-19	19	L = 25 m

Pour verre feuilleté

205124-050-08	8,76 - 10,76	L = 5 m
205124-050-11	11,52 - 13,52	L = 5 m
205124-050-17	16,76 - 17,52	L = 5 m
NEW 205124-050-92	20,76 - 21,52	L = 5 m
205124-250-08	8,76 - 10,76	L = 25 m
205124-250-11	11,52 - 13,52	L = 25 m
205124-250-17	16,76 - 17,52	L = 25 m
NEW 205124-250-92	20,76 - 21,52	L = 25 m

Q-INFO MOD 6920

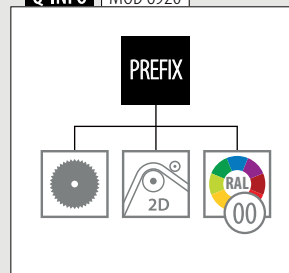

Q-INFO Aluminium

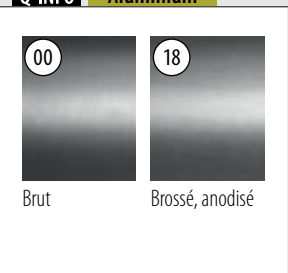

Q-INFO MOD 6920 / 5124 / 6732

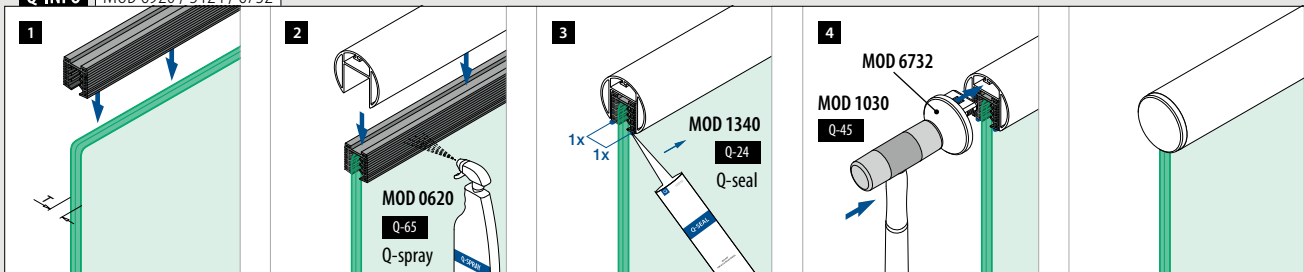

Raccords

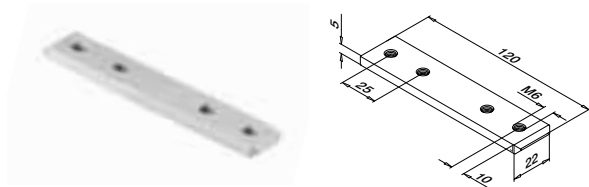

MOD 6795

Aluminium	Brut		
166795-339	QS-261	472	2

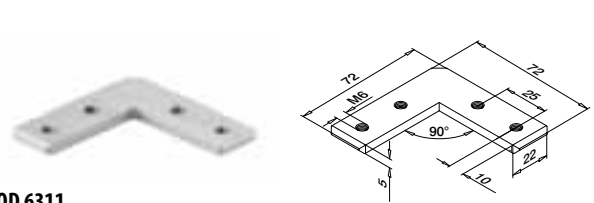

MOD 6311

Aluminium	Brut		
166311-339	QS-261	472	2

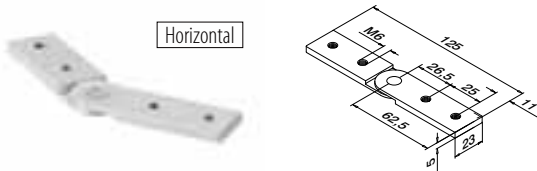

MOD 6797

Aluminium	Brut		
166797	QS-261	472	2

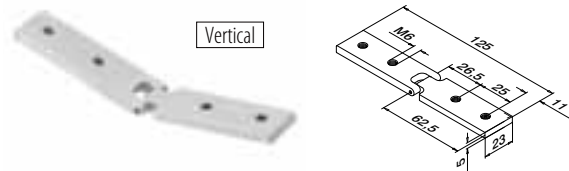

MOD 6798

Aluminium	Brut		
166798	QS-261	472	2

Q-INFO MOD 6311

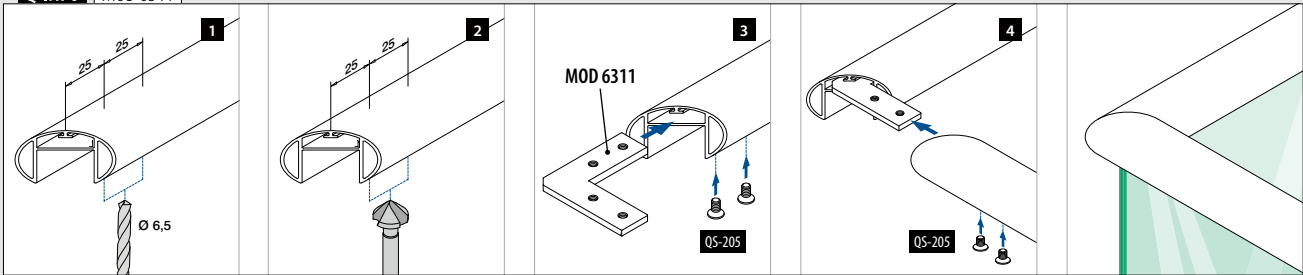

Q-INFO MOD 6797

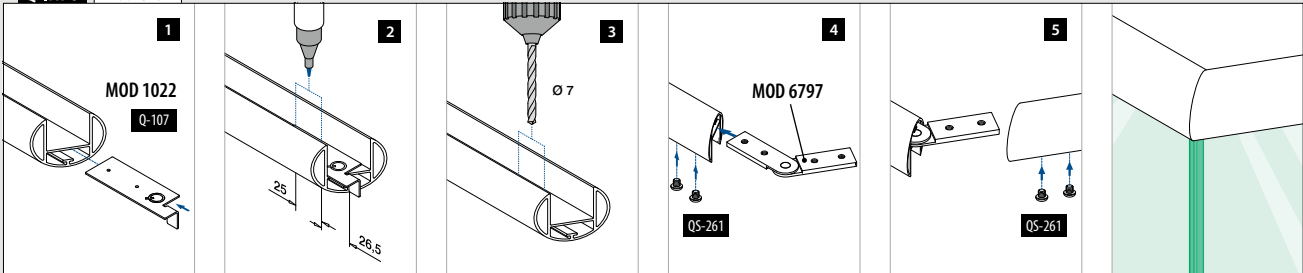

Q-INFO MOD 6798

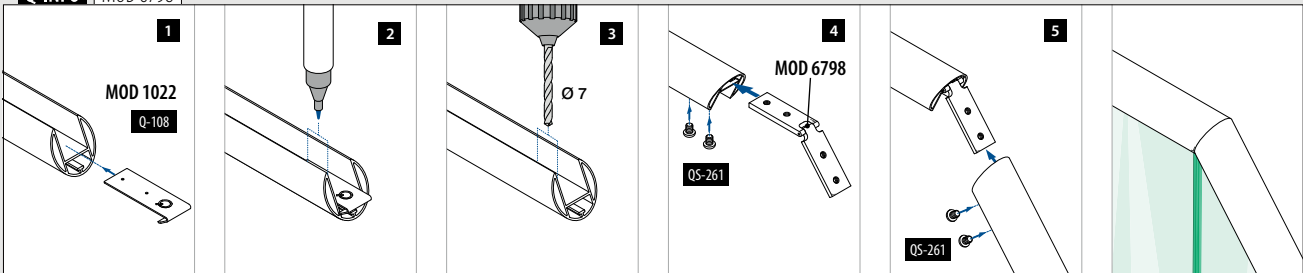

Q-INFO MOD 6798

En haut

Couper	45°	40°	35°	30°	25°	20°	15°	10°	5°	0°
Angle externe	90°	100°	110°	120°	130°	140°	150°	160°	170°	180°
Distance du bord (x)	30,5	30,0	29,5	29,0	28,5	28,0	27,5	27,0	27,0	26,5

En bas

Couper	0°	5°	10°	15°	20°	25°	30°	35°	40°	45°
Angle interne	180°	170°	160°	150°	140°	130°	120°	110°	100°	90°
Distance du bord (x)	26,5	26,5	26,0	26,0	25,5	25,5	25,0	24,5	24,5	24,0

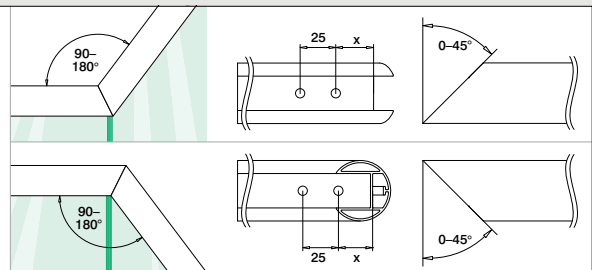

Mains-courantes

Tubes à fond de gorge

Carré □

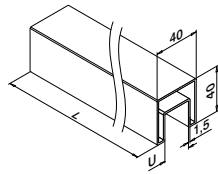

MOD 6924

304 Inox brossé

INDOOR

SELL OUT	U	□	⊞
136924-040-25-12	24	40 x 40	L = 2,5 m
136924-040-50-12	24	40 x 40	L = 5 m

316 Inox brossé

OUTDOOR

146924-040-25-12	24	40 x 40	L = 2,5 m
146924-040-50-12	24	40 x 40	L = 5 m



Mains-courantes

Joint pour fond de gorge

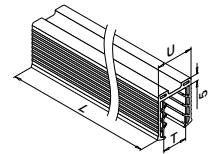

MOD 5124

Accessoires

U = 24 mm

Pour verre monolithique	T	⊞
205124-050-08	8 - 10	L = 5 m
205124-050-11	12	L = 5 m
205124-050-15	15	L = 5 m
205124-050-19	19	L = 5 m
205124-250-08	8 - 10	L = 25 m
205124-250-11	12	L = 25 m
205124-250-15	15	L = 25 m
205124-250-19	19	L = 25 m

Pour verre feuilleté

205124-050-08	8,76 - 10,76	L = 5 m
205124-050-11	11,52 - 13,52	L = 5 m
205124-050-17	16,76 - 17,52	L = 5 m
NEW 205124-050-92	20,76 - 21,52	L = 5 m
205124-250-08	8,76 - 10,76	L = 25 m
205124-250-11	11,52 - 13,52	L = 25 m
205124-250-17	16,76 - 17,52	L = 25 m
NEW 205124-250-92	20,76 - 21,52	L = 25 m

Q-INFO MOD 6924

PREFIX



Q-INFO MOD 6924 / 5124 / 6734

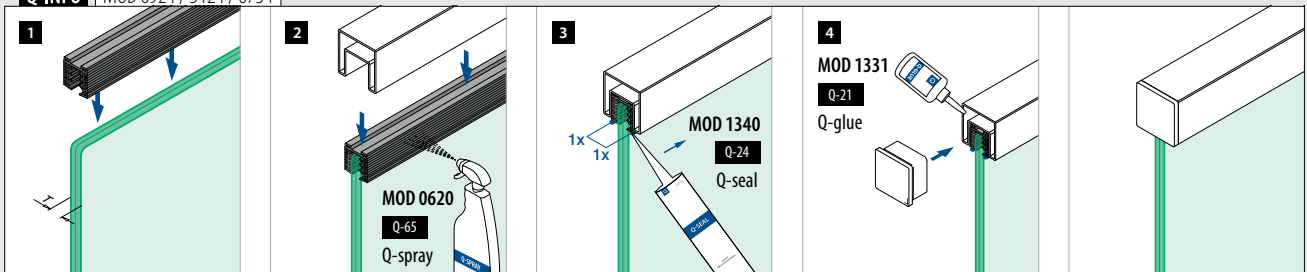

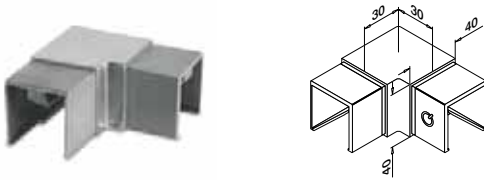
**MOD 6343**

304 Inox brossé			
INDOOR	<input type="checkbox"/>	<input type="checkbox"/>	<input type="checkbox"/>
136343-040-12	40 x 40		2
316 Inox brossé			
OUTDOOR	<input type="checkbox"/>	<input type="checkbox"/>	<input type="checkbox"/>
146343-040-12	40 x 40		2

**MOD 6794**

304 Inox brossé			
INDOOR	<input type="checkbox"/>	<input type="checkbox"/>	<input type="checkbox"/>
136794-040-12	40 x 40		2
316 Inox brossé			
OUTDOOR	<input type="checkbox"/>	<input type="checkbox"/>	<input type="checkbox"/>
146794-040-12	40 x 40		2

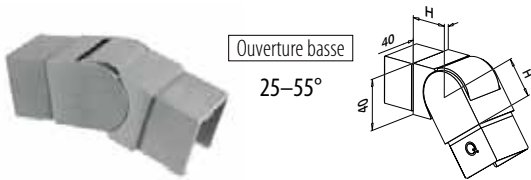
**MOD 6342**

304 Inox brossé			
INDOOR	<input type="checkbox"/>	H	<input type="checkbox"/>
136342-040-02-12	40 x 40	30	2
316 Inox brossé			
OUTDOOR	<input type="checkbox"/>	H	<input type="checkbox"/>
146342-040-02-12	40 x 40	30	2

**MOD 6342**

304 Inox brossé			
INDOOR	<input type="checkbox"/>	H	<input type="checkbox"/>
136342-040-01-12	40 x 40	30	2
316 Inox brossé			
OUTDOOR	<input type="checkbox"/>	H	<input type="checkbox"/>
146342-040-01-12	40 x 40	30	2

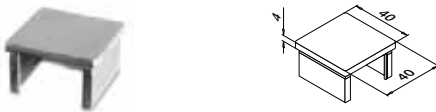
**MOD 6734**

304 Inox brossé			
INDOOR	<input type="checkbox"/>	<input type="checkbox"/>	<input type="checkbox"/>
136734-040-12	40 x 40		2
316 Inox brossé			
OUTDOOR	<input type="checkbox"/>	<input type="checkbox"/>	<input type="checkbox"/>
146734-040-12	40 x 40		2

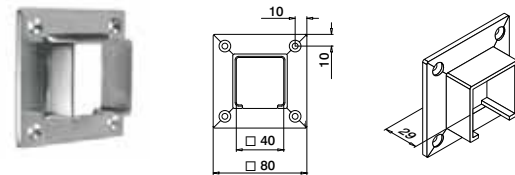
**MOD 6545**

304 Inox brossé			
INDOOR	<input type="checkbox"/>	<input type="checkbox"/>	<input type="checkbox"/>
136545-040-12	40 x 40	QS-7 <input type="checkbox"/> 471	2
316 Inox brossé			
OUTDOOR	<input type="checkbox"/>	<input type="checkbox"/>	<input type="checkbox"/>
146545-040-12	40 x 40	QS-50 <input type="checkbox"/> 471	2



Mains-courantes

Tubes à fond de gorge

Carré □

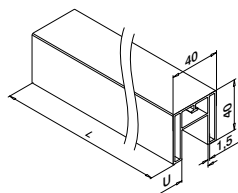
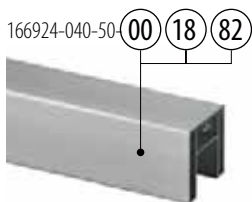

MOD 6924

Aluminium	Brut	U	□	⊞
166924-040-50-00		24	40 x 40	L = 5 m
Aluminium	Brossé, anodisé			
OUTDOOR				
166924-040-50-18		24	40 x 40	L = 5 m
Aluminium	Black Line			
OUTDOOR				
NEW 166924-040-50-82		24	40 x 40	L = 5 m



International Design Modèle Protection

Mains-courantes

Joint pour fond de gorge

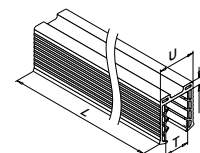

MOD 5124

Accessoires		
U = 24 mm		
Pour verre monolithique	T	⊞
205124-050-08	8 - 10	L = 5 m
205124-050-11	12	L = 5 m
205124-050-15	15	L = 5 m
205124-050-19	19	L = 5 m
Pour verre feuilleté		
205124-050-08	8,76 - 10,76	L = 5 m
205124-050-11	11,52 - 13,52	L = 5 m
205124-050-17	16,76 - 17,52	L = 5 m
NEW 205124-050-92	20,76 - 21,52	L = 5 m

Mains-courantes

Angles

Carré □

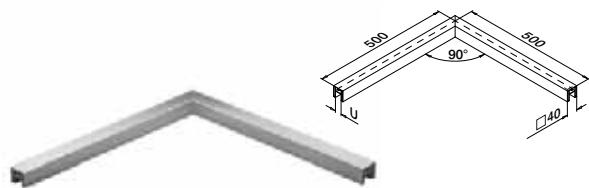

MOD 6324

Aluminium	Brossé, anodisé	U	□	⊞
OUTDOOR				
166324-040-18		24	40 x 40 x 1,5	1
Aluminium	Black Line			
OUTDOOR				
NEW 166324-040-82		24	40 x 40 x 1,5	1

Mains-courantes

Embout

Carré □

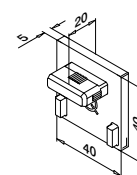

MOD 6734 - EASY HIT®

Aluminium	Brut	□	⊞
166734-040-00		40 x 40	2
Aluminium	Brossé, anodisé		
OUTDOOR			
166734-040-18		40 x 40	2
Aluminium	Black Line		
OUTDOOR			
NEW 166734-040-82		40 x 40	2



International Design Modèle Protection

Q-INFO Aluminium



Q-INFO MOD 6924

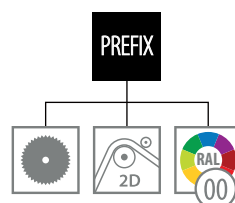

Q-INFO MOD 6924 / 5124 / 6734

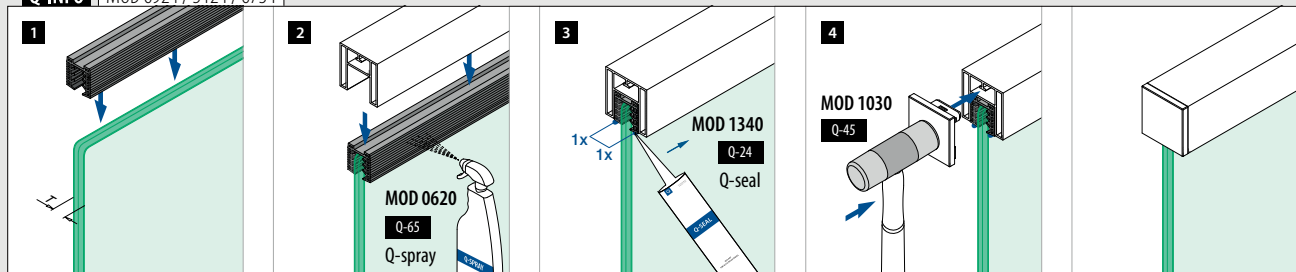

Raccords

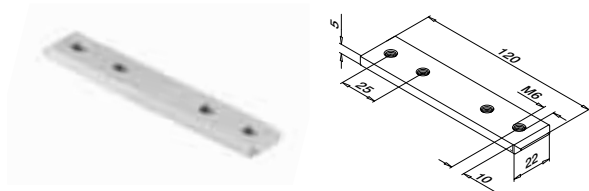

MOD 6795

Aluminium	Brut		
166795-339	QS-261	472	2

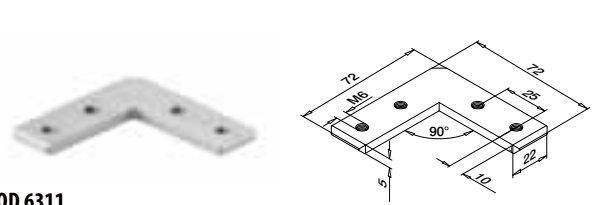

MOD 6311

Aluminium	Brut		
166311-339	QS-261	472	2

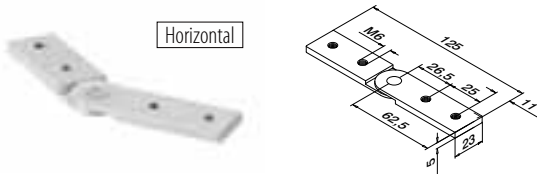

MOD 6797

Aluminium	Brut		
166797	QS-261	472	2

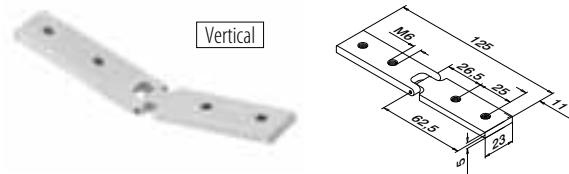

MOD 6798

Aluminium	Brut		
166798	QS-261	472	2

Q-INFO MOD 6311

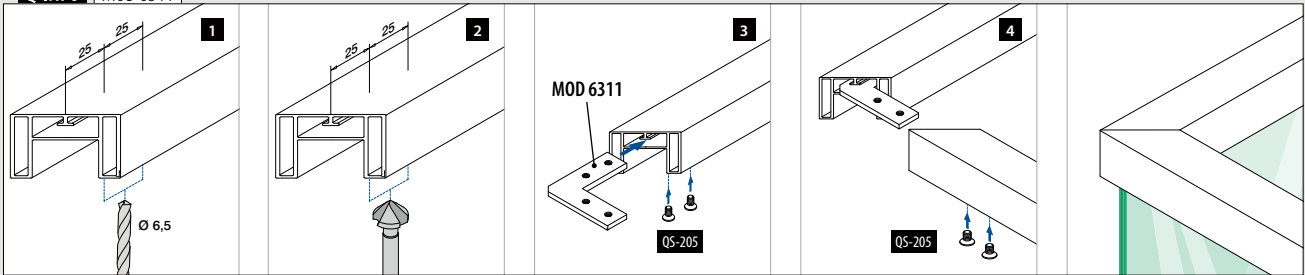

Q-INFO MOD 6797

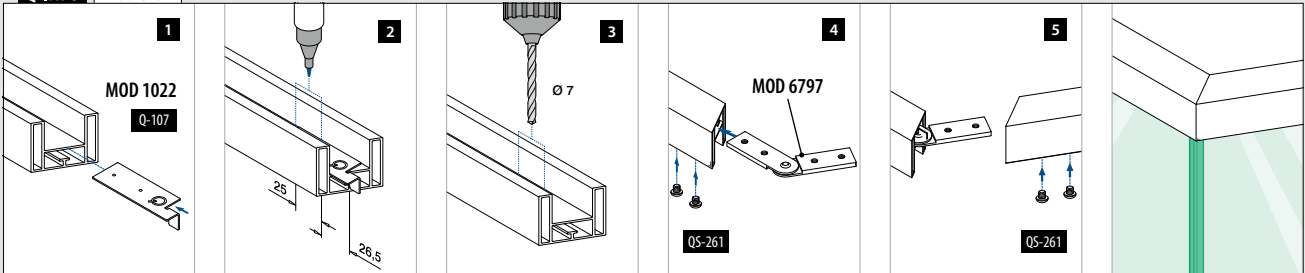

Q-INFO MOD 6798

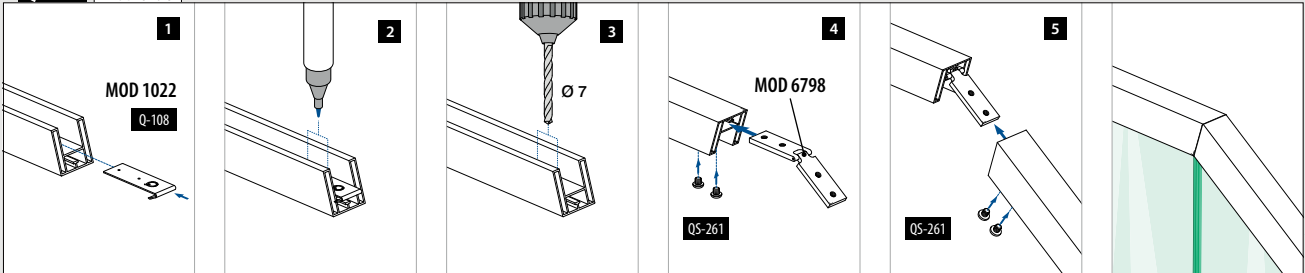

Q-INFO MOD 6798

En haut

Couper	45°	40°	35°	30°	25°	20°	15°	10°	5°	0°
Angle externe	90°	100°	110°	120°	130°	140°	150°	160°	170°	180°
Distance du bord (x)	30,5	30,0	29,5	29,0	28,5	28,0	27,5	27,0	27,0	26,5

En bas

Couper	0°	5°	10°	15°	20°	25°	30°	35°	40°	45°
Angle interne	180°	170°	160°	150°	140°	130°	120°	110°	100°	90°
Distance du bord (x)	26,5	26,5	26,0	26,0	25,5	25,5	25,0	24,5	24,5	24,0

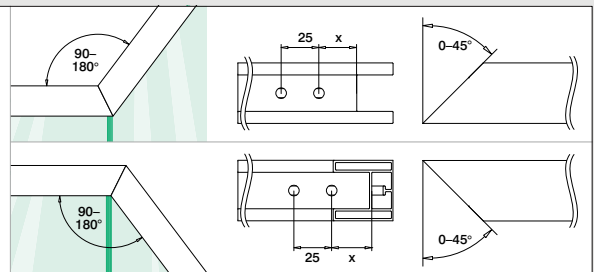

Mains-courantes

Tubes à fond de gorge

Rectangulaire

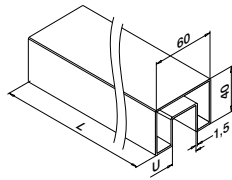

MOD 6924

304 Inox brossé

INDOOR

U



136924-640-50-12

24

60 x 40

L = 5 m

316 Inox brossé

OUTDOOR

146924-640-50-12

24

60 x 40

L = 5 m

PREFIX



Mains-courantes

Joint pour fond de gorge

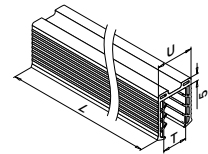

MOD 5124

Accessoires

U = 24 mm

Pour verre monolithique

T



205124-050-08

8 - 10

L = 5 m

205124-050-11

12

L = 5 m

205124-050-15

15

L = 5 m

205124-050-19

19

L = 5 m

205124-250-08

8 - 10

L = 25 m

205124-250-11

12

L = 25 m

205124-250-15

15

L = 25 m

205124-250-19

19

L = 25 m

Pour verre feuilleté

205124-050-08

8,76 - 10,76

L = 5 m

205124-050-11

11,52 - 13,52

L = 5 m

205124-050-17

16,76 - 17,52

L = 5 m

NEW

205124-050-92

20,76 - 21,52

L = 5 m

205124-250-08

8,76 - 10,76

L = 25 m

205124-250-11

11,52 - 13,52

L = 25 m

205124-250-17

16,76 - 17,52

L = 25 m

NEW

205124-250-92

20,76 - 21,52

L = 25 m

Q-INFO MOD 6924

PREFIX



Q-INFO MOD 6924 / 5124 / 6734

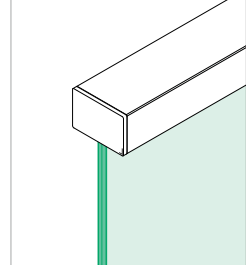
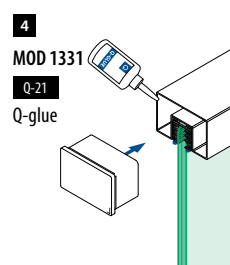
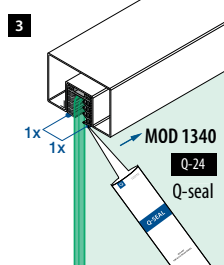
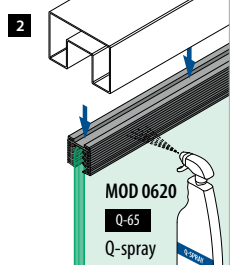
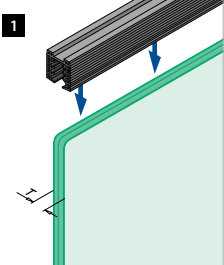

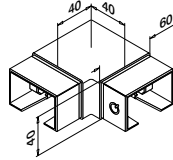
**MOD 6343****304** Inox brossé**INDOOR****Pour** 

SELL OUT	136343-640-12	60 x 40	2
-----------------	---------------	---------	---

316 Inox brossé**OUTDOOR**

	146343-640-12	60 x 40	2
--	---------------	---------	---

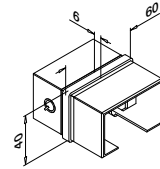
**MOD 6794****304** Inox brossé**INDOOR****Pour** 

SELL OUT	136794-640-12	60 x 40	2
-----------------	---------------	---------	---

316 Inox brossé**OUTDOOR**

	146794-640-12	60 x 40	2
--	---------------	---------	---



25–55°

Ouverture basse

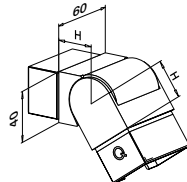
**MOD 6342****304** Inox brossé**INDOOR****Pour** **H**

SELL OUT	136342-640-02-12	60 x 40	30	2
-----------------	------------------	---------	----	---

316 Inox brossé**OUTDOOR**

	146342-640-02-12	60 x 40	30	2
--	------------------	---------	----	---



25–55°

Ouverture haute

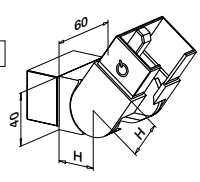
**MOD 6342****304** Inox brossé**INDOOR****Pour** **H**

SELL OUT	136342-640-01-12	60 x 40	30	2
-----------------	------------------	---------	----	---

316 Inox brossé**OUTDOOR**

	146342-640-01-12	60 x 40	30	2
--	------------------	---------	----	---

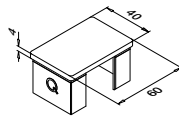
**MOD 6734****304** Inox brossé**INDOOR****Pour** 

SELL OUT	136734-640-12	60 x 40	2
-----------------	---------------	---------	---

316 Inox brossé**OUTDOOR**

	146734-640-12	60 x 40	2
--	---------------	---------	---

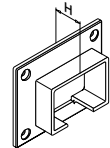
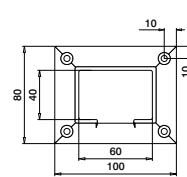
**MOD 6545****304** Inox brossé**INDOOR****Pour** **H**

SELL OUT	136545-640-12	60 x 40	29	QS-7	471	2
-----------------	---------------	---------	----	------	-----	---

316 Inox brossé**OUTDOOR**

	146545-640-12	60 x 40	29	QS-50	471	2
--	---------------	---------	----	-------	-----	---



Mains-courantes

Tubes à fond de gorge

Rectangulaire

166924-654-50-00 08

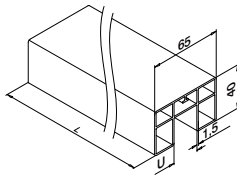
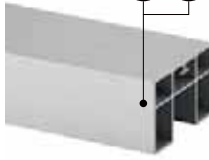

MOD 6924

Aluminium	Brut	U	□	▢
166924-654-50-00		24	65 x 40	L = 5 m
Aluminium	Effet argenté mat			
OUTDOOR				
166924-654-50-08		24	65 x 40	L = 5 m

SELL OUT



International Design Modèle Protection

Mains-courantes

Embouts

Rectangulaire

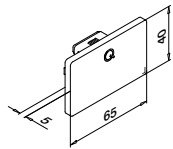

MOD 6734 - EASY HIT®

Aluminium	Brut	Pour □	▢
166734-654-00		65 x 40	2
Aluminium	Effet argenté mat		
OUTDOOR			
166734-654-08		65 x 40	2

SELL OUT



International Design Modèle Protection

Mains-courantes

Joint pour fond de gorge

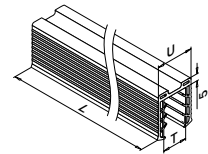

MOD 5124

Accessoires		
U = 24 mm		
Pour verre monolithique	T	▢
205124-050-08	8 - 10	L = 5 m
205124-050-11	12	L = 5 m
205124-050-15	15	L = 5 m
205124-050-19	19	L = 5 m
Pour verre feuilleté		
205124-050-08	8,76 - 10,76	L = 5 m
205124-050-11	11,52 - 13,52	L = 5 m
205124-050-17	16,76 - 17,52	L = 5 m
NEW 205124-050-92	20,76 - 21,52	L = 5 m

Mains-courantes

Embases murales pour tube

Rectangulaire

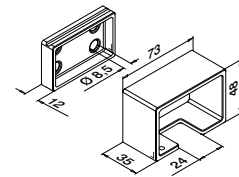

MOD 6545

Aluminium	Brut	Pour □	▢
166545-654-00		65 x 40	2



International Design Modèle Protection

SELL OUT Seulement jusqu'à épuisement des stocks.

Q-INFO MOD 6924

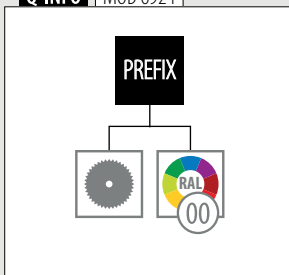

Q-INFO Aluminium

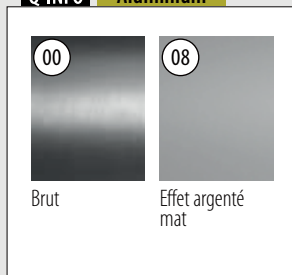

Q-INFO MOD 6924



Q-INFO MOD 6924 / 5124 / 6734

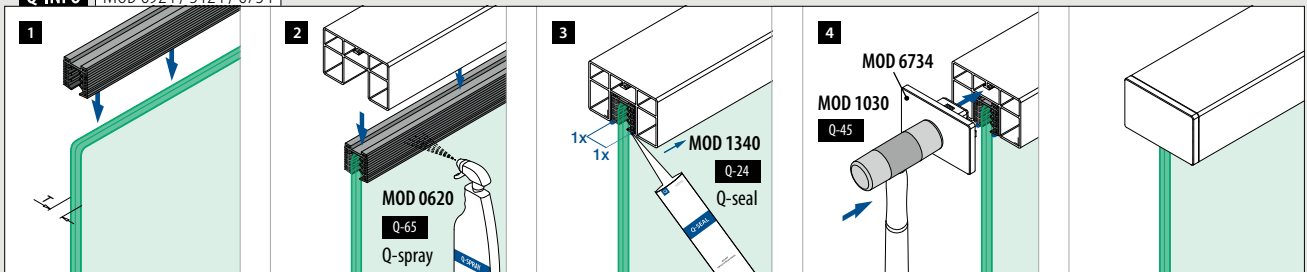

Raccords

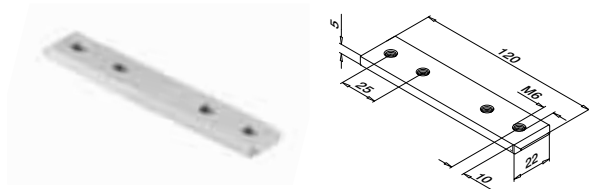

MOD 6795

Aluminium	Brut		
166795-339	QS-261	472	2

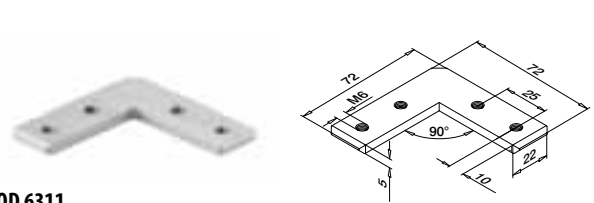

MOD 6311

Aluminium	Brut		
166311-339	QS-261	472	2

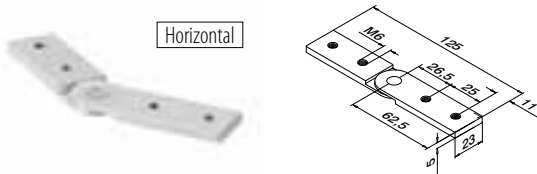

MOD 6797

Aluminium	Brut		
166797	QS-261	472	2

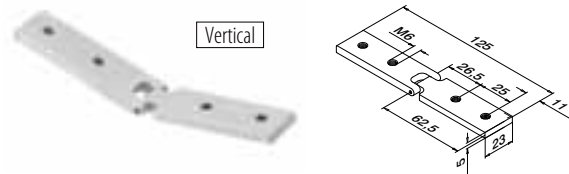

MOD 6798

Aluminium	Brut		
166798	QS-261	472	2

Q-INFO MOD 6311

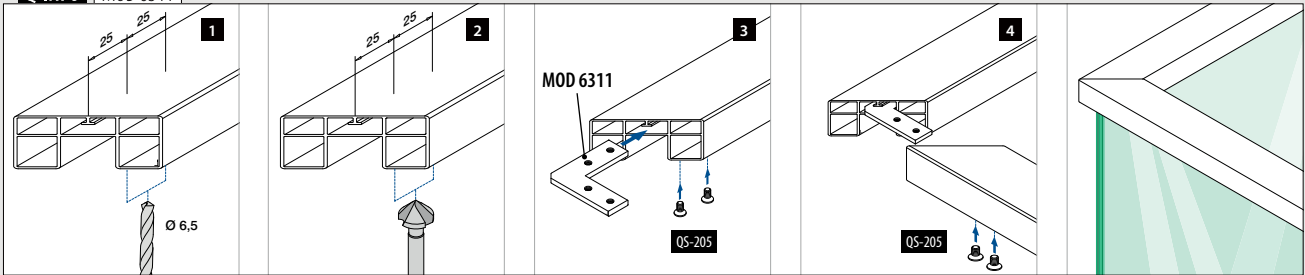

Q-INFO MOD 6797

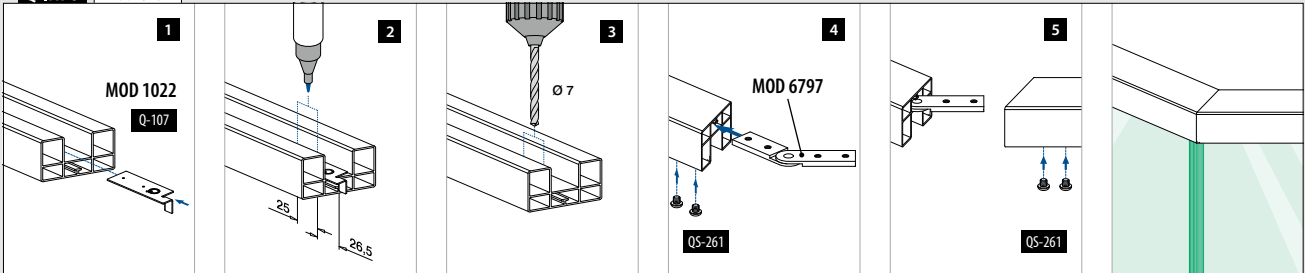

Q-INFO MOD 6798

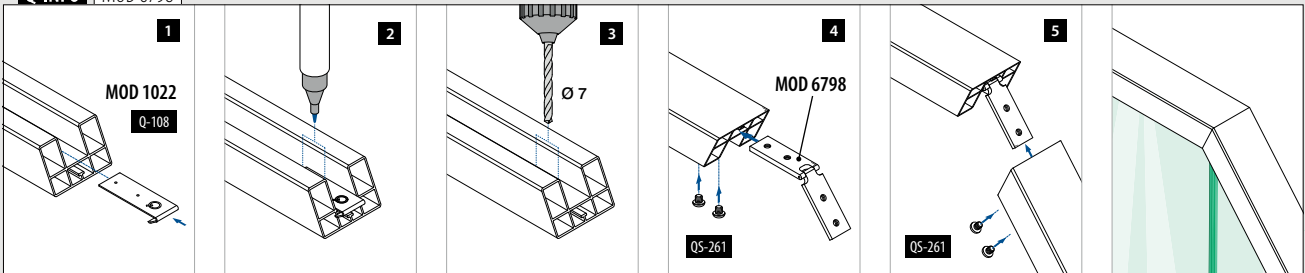

Q-INFO MOD 6798

En haut

Couper	45°	40°	35°	30°	25°	20°	15°	10°	5°	0°
Angle externe	90°	100°	110°	120°	130°	140°	150°	160°	170°	180°
Distance du bord (x)	30,5	30,0	29,5	29,0	28,5	28,0	27,5	27,0	27,0	26,5

En bas

Couper	0°	5°	10°	15°	20°	25°	30°	35°	40°	45°
Angle interne	180°	170°	160°	150°	140°	130°	120°	110°	100°	90°
Distance du bord (x)	26,5	26,5	26,0	26,0	25,5	25,5	25,0	24,5	24,5	24,0

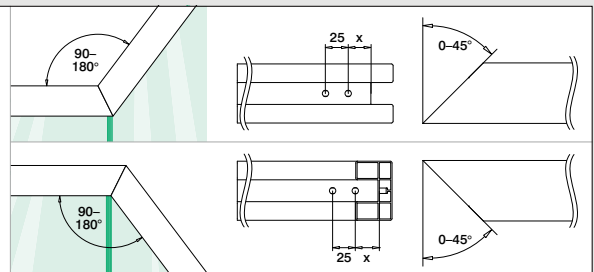

Mains-courantes

Tubes à fond de gorge

HYBRID 33x39

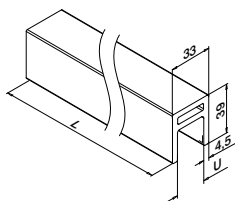
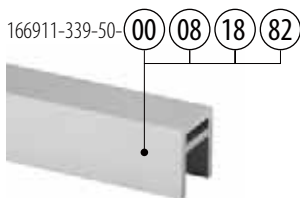

MOD 6911

Aluminium	Brut	U	L = 5 m
166911-339-50-00	24		
Aluminium	Effet argenté mat	OUTDOOR	
166911-339-50-08	24		L = 5 m
Aluminium	Brossé, anodisé	OUTDOOR	
166911-339-50-18	24		L = 5 m
Aluminium	Black Line	OUTDOOR	
166911-339-50-82	24		L = 5 m



International Design Modèle Protection

Mains-courantes

Joint pour fond de gorge

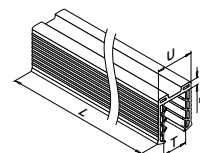

MOD 5124

Accessoires		
U = 24 mm		
Pour verre monolithique	T	L = 5 m
205124-050-08	8 - 10	
Pour verre feuilleté		
205124-050-08	8,76 - 10,76	L = 5 m
205124-050-11	11,52 - 13,52	L = 5 m

Mains-courantes

Embases murales pour tube

HYBRID 33x39

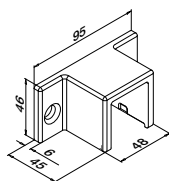

MOD 6515

316	Inox brossé	OUTDOOR	2
146515-339-12	QS-214 468		
316	Black Line	OUTDOOR	
146515-339-82	QS-214 468		2



Q-INFO Aluminium

00	08	18	82 RAL 9005
Brut	Effet argenté mat	Brossé, anodisé	Noir, mat, texture Thermolaqué

Q-INFO 316

12	82 RAL 9005
Inox brossé	Noir, mat, texture Thermolaqué

Q-INFO MOD 6911

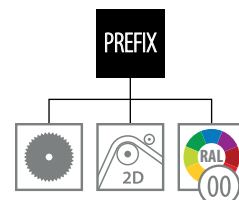

Q-INFO

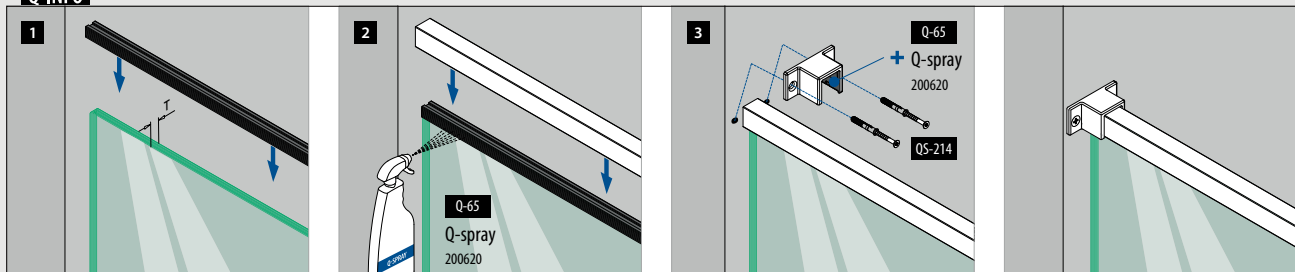



Gauche / droite

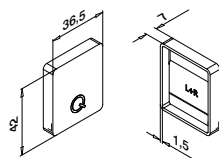

MOD 6913

Aluminium	Brut	
166913-339-00		2
Aluminium	Effet argenté mat	
OUTDOOR		
SELL OUT		
166913-339-08		2
Aluminium	Brossé, anodisé	
OUTDOOR		
NEW		
166913-339-18		2
Aluminium	Black Line	
OUTDOOR		
NEW		
166913-339-82		2

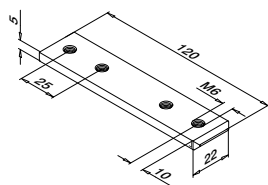

MOD 6795

Aluminium	Brut		
166795-339		QS-261 472	2

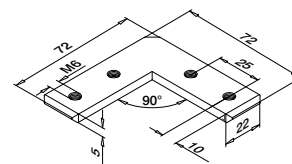

MOD 6311

Aluminium	Brut		
166311-339		QS-261 472	2

SELL OUT Seulement jusqu'à épuisement des stocks.

Q-INFO MOD 6311

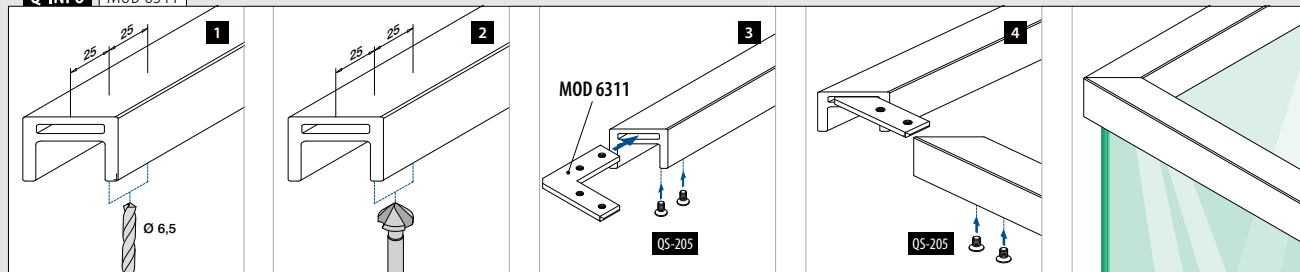



2

SYSTÈMES DE PROTECTION DE FENÊTRES

Easy Glass® View	190 - 197
Easy Glass® MOD 6507-6508	198 - 209
Avec pinces à verre	210 - 211
Avec adaptateurs à verre	212 - 217
Barres d'appui	218 - 231



EASY GLASS® MOD 6507 / 6508

198



Retrouvez toutes les informations sur protection de fenêtres en ligne :

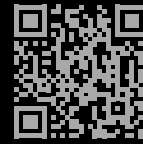

<https://q-ne.ws/JulietBalcony23>

AVEC ADAPTEURS À VERRE

212

AVEC PINCES À VERRE

210

BARRES D'APPUI

218



POLYVALENTS ET PRESQUE INVISIBLES

Les fenêtres s'élevant du sol au plafond sont très prisées dans les immeubles d'habitation et de bureaux pour profiter au maximum de la lumière naturelle. Elles nécessitent toutefois d'être équipées d'un balcon à la française offrant une protection suffisante contre les chutes.

Vous trouverez parmi nos produits deux systèmes répondant spécifiquement à ce besoin.

Le premier, Easy Glass® View, peut s'installer sur la façade, mais également sur le tableau ou le cadre d'une fenêtre. Le second, Easy Glass® MOD 6507-6508, vous permet de choisir entre des embases murales et des tubes à fond de gorge ronds ou carrés.

Les pinces et adaptateurs à verre de Q-railing constituent d'autres solutions pour créer des balcons à la française en verre. Les barres d'appui sont elles aussi un moyen efficace de protéger les fenêtres de grand format. Optez pour des éléments ronds ou carrés afin d'obtenir l'effet désiré avec ces alternatives.



EASY GLASS®
VIEW

190



Q-railing



Conçu pour : Utilisation faible à moyenne
Utilisation : Intérieur et extérieur
Variantes : Montage mural (façade, cadre des fenêtres, entre murs)
Applications : Protection de fenêtres
Matériau : Aluminium (brossé anodisé, brut et thermolaqué)
Épaisseur de verre : 12 à 21,52 mm

Retrouvez toutes les informations sur Easy Glass View en ligne :

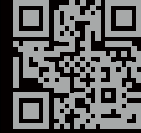

<https://q-ne.ws/View23>

EASY GLASS[®] VIEW



Protection de fenêtres minimalistes pour une sécurité optimale

Vous pouvez installer le balcon à la française Easy Glass® View sur la façade, le tableau d'une fenêtre ou directement sur le cadre d'une fenêtre pour un résultat presque invisible. Ses fins profils en aluminium peuvent être thermolaqués pour s'accorder aux cadres de fenêtre ou à la façade.

Easy Glass® View	BE
Max. charge linéaire (kN/m)	1,0
Max. vent (mètre)	3,0

Merci de prendre en considération les spécifications de chaque certificat telles qu'épaisseur du verre, fixation.

Tests/calculs/certificats internationaux:



- 1 Créez une protection de fenêtres quasi invisible grâce aux profils extrêmement fins et aux points de fixation discrets d'Easy Glass View.
- 2 Choisissez parmi plusieurs installations possibles, dont le déport en façade ou l'installation entre deux murs ou sur le cadre d'une fenêtre.



DÉCLINAISONS DE EASY GLASS® VIEW

- Montage avec goujons ou vis (en fonction de la surface)
- Le montage entre des tableaux de fenêtre peut s'effectuer de l'intérieur
- Les profils et embouts peuvent être revêtus par poudre

Montage en façade

Montage sur cadre

Montage entre murs

Montage avec profile de liaison centrale

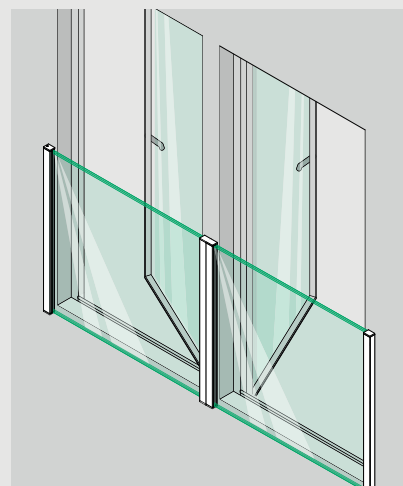
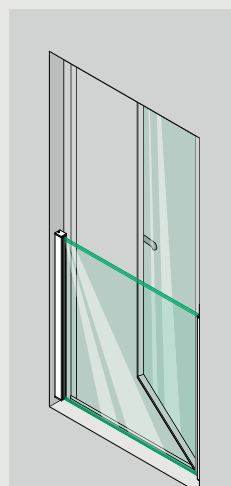
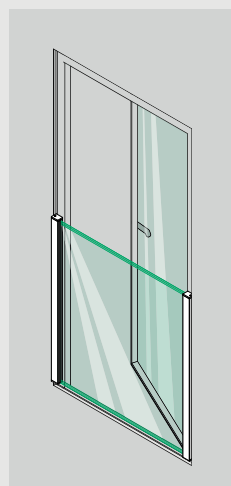
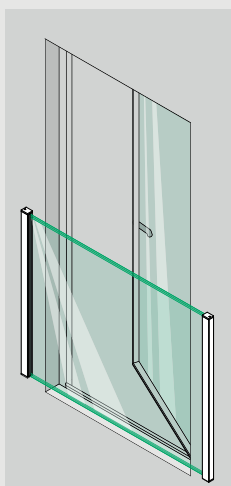

Profil de mur

Easy Glass® View

Montage en façade

Montage entre murs

Montage sur cadre

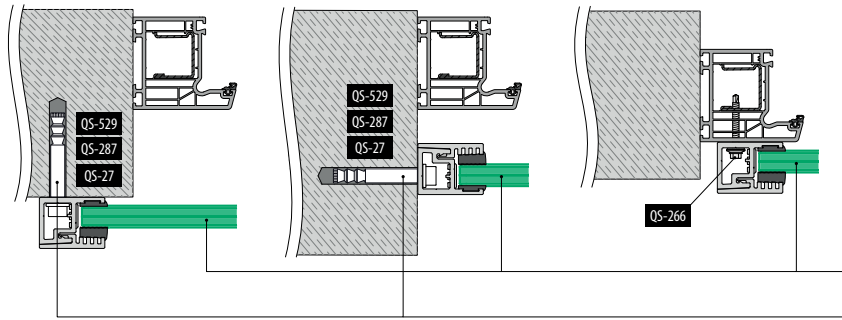

Merci de prendre en considération les spécifications de chaque certificat telles qu'épaisseur du verre, fixation et types de verre.

Verre de sécurité : 160 - 161

Fixations : 457 - 463

Montage avec profile de liaison centrale

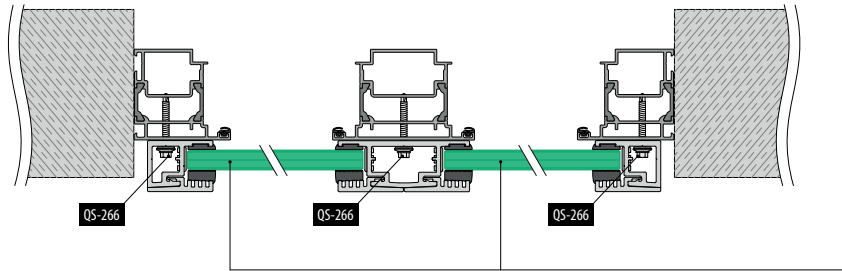

Verre de sécurité : 160 - 161

Profil de mur

Sets de profils complets

Pré-percé

Y compris : 2 profils pour hauteur de verres 1100 mm, 4 caches et 4 embouts

Y compris : 2 profils pour hauteur de verres 1100 mm, 4 caches et 4 embouts

Montage entre murs

Montage en façade / sur cadre

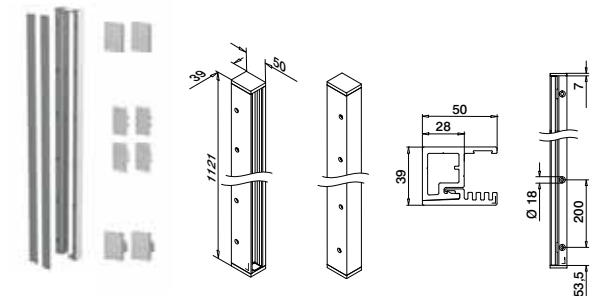
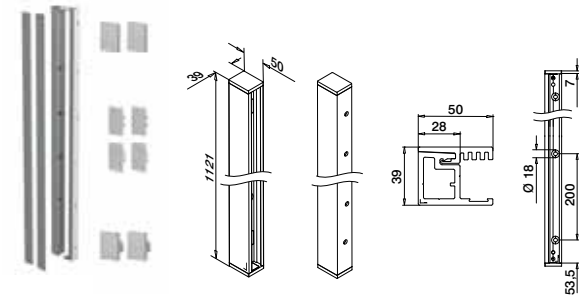

MOD 6839

Aluminium Brut

166839-011-02-00 457 - 463 L = 2x 1,1 m

Aluminium Brossé, anodisé

OUTDOOR

166839-011-02-18 457 - 463 L = 2x 1,1 m



MOD 6839

Aluminium Brut

166839-011-01-00 457 - 463 L = 2x 1,1 m

Aluminium Brossé, anodisé

OUTDOOR

166839-011-01-18 457 - 463 L = 2x 1,1 m



Q-INFO

Pour verre monolithique	T	a
	20683x-xxx-12	12
20683x-xxx-15	15	10,5
20683x-xxx-19	19	6,5
Pour verre feuilleté		
20683x-xxx-13	12,76	10,5
20683x-xxx-14	13,52	10,5
20683x-xxx-17	16,76	6,5
20683x-xxx-18	17,52	6,5
20683x-xxx-21	20,76	6,5
20683x-xxx-22	21,52	6,5

Q-INFO

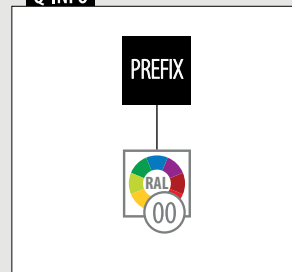

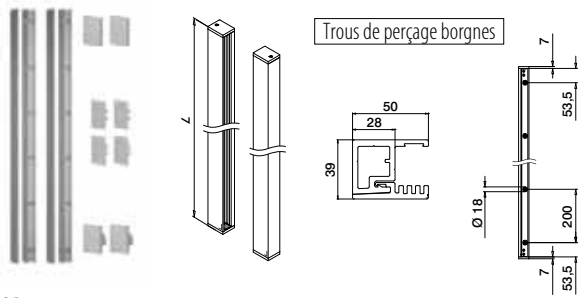

Sets de profils complets

Y compris: 2 profils pour hauteur de verres 1100 mm, 4 caches et 4 embouts



MOD 6839

Aluminium	Brut		
166839-011-00-00	457 - 463	L = 2x 1,1 m	
Aluminium	Brossé, anodisé		
OUTDOOR			
166839-011-00-18	457 - 463	L = 2x 1,1 m	
Aluminium	Gris anthracite RAL 7016		
OUTDOOR			
NEW	166839-011-00-33	457 - 463	L = 2x 1,1 m
Aluminium	Black Line		
OUTDOOR			
NEW	166839-011-00-82	457 - 463	L = 2x 1,1 m



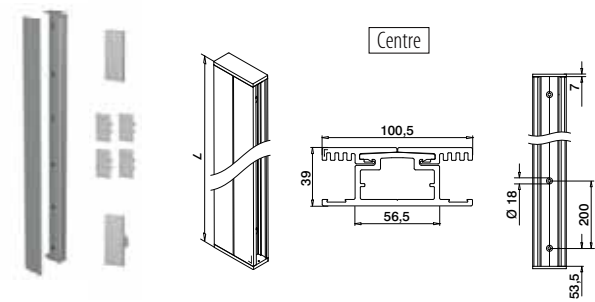

International Design Modèle Protection

Y compris: 1 profil pour hauteur de verres 1100 mm, 4 caches et 2 embouts



MOD 6849

Aluminium	Brut		
166849-011-00-00	457 - 463	L = 1,1 m	
Aluminium	Brossé, anodisé		
OUTDOOR			
166849-011-00-18	457 - 463	L = 1,1 m	
Aluminium	Gris anthracite RAL 7016		
OUTDOOR			
166849-011-00-33	457 - 463	L = 1,1 m	
Aluminium	Black Line		
OUTDOOR			
166849-011-00-82	457 - 463	L = 1,1 m	



Q-INFO Aluminium

00	18	33 RAL 7016	82 RAL 9005
			
Brut	Brossé, anodisé	Gris anthracite, mat, uni	Noir, mat, texture Thermolaqué

Q-INFO

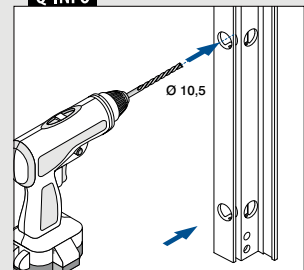

Set de cales en caoutchouc pour set de profils



Compatible avec
MOD 6839 et MOD 6849

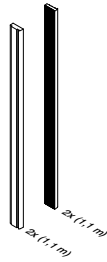

MOD 6831

Accessoires

Pour verre monolithique		T	
206831-211-12	12	L = 2x 1,1 m	
206831-211-15	15	L = 2x 1,1 m	
206831-211-19	19	L = 2x 1,1 m	

Pour verre feuilleté

206831-211-13	12,76	L = 2x 1,1 m
206831-211-14	13,52	L = 2x 1,1 m
206831-211-17	16,76	L = 2x 1,1 m
206831-211-18	17,52	L = 2x 1,1 m
206831-211-21	20,76	L = 2x 1,1 m
206831-211-22	21,52	L = 2x 1,1 m

NEW

Q-INFO

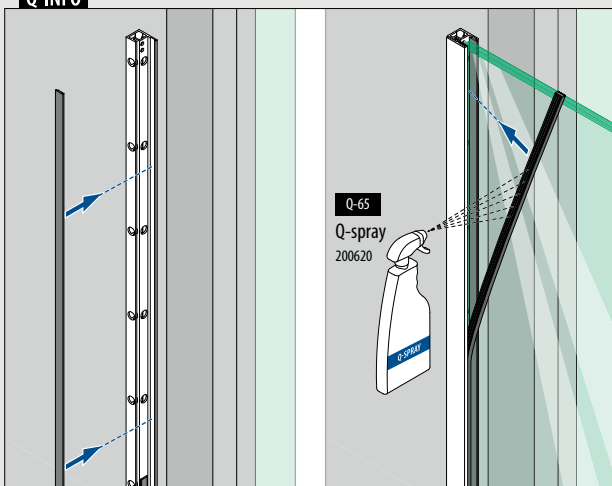

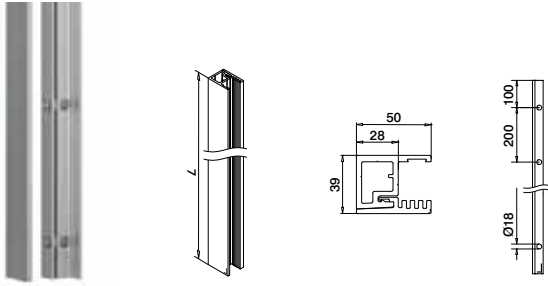

Profils de mur seuls

Trous de perçage borgnes



MOD 6830

Aluminium Brut		
166830-050-00-00	457 - 463	L = 5 m
Aluminium Brossé, anodisé		
OUTDOOR		
166830-050-00-18	457 - 463	L = 5 m



International Design
Modèle Protection



Profils de mur seuls

Pré-perçé

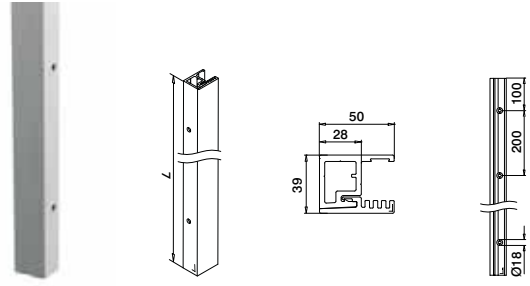
Montage entre murs



MOD 6830



Aluminium Brut		
166830-050-02-00	457 - 463	L = 5 m
Aluminium Brossé, anodisé		
OUTDOOR		
166830-050-02-18	457 - 463	L = 5 m

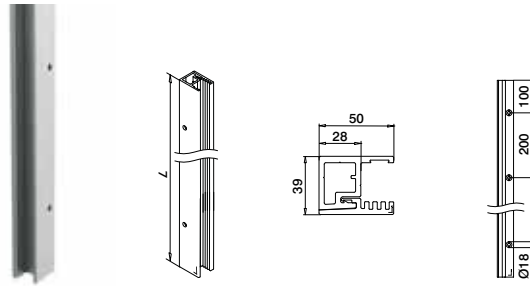

Montage en façade / sur cadre



MOD 6830



Aluminium Brut		
166830-050-01-00	457 - 463	L = 5 m
Aluminium Brossé, anodisé		
OUTDOOR		
166830-050-01-18	457 - 463	L = 5 m

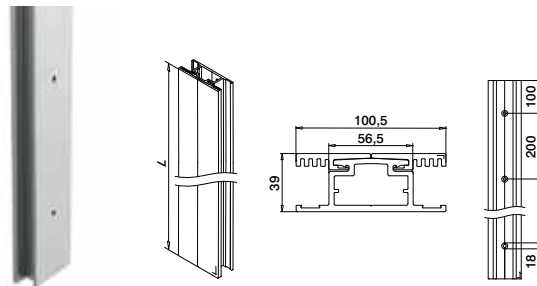

Centre



MOD 6840

Aluminium Brut		
166840-050-00-00	457 - 463	L = 5 m
Aluminium Brossé, anodisé		
OUTDOOR		
166840-050-00-18	457 - 463	L = 5 m



Q-INFO

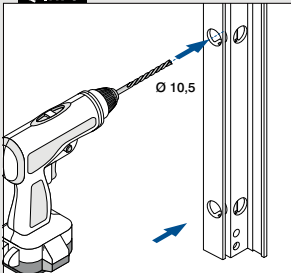

Q-INFO

Aluminium

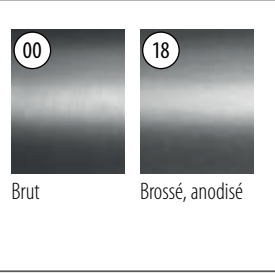

Q-INFO

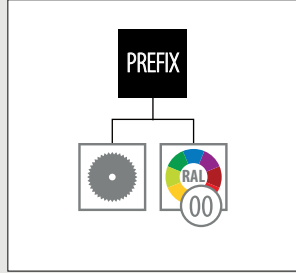

Q-INFO

MOD 6830-050-00

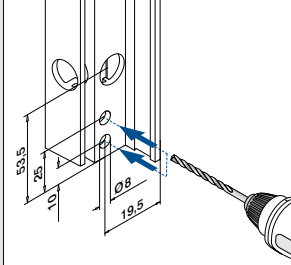

Q-INFO

MOD 6830-050-01

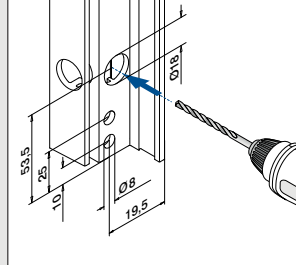

Set de cales en caoutchouc pour profils de mur



Compatible avec
MOD 6839 et MOD 6849

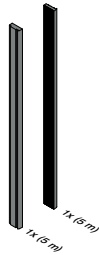

MOD 6831

Accessoires

Pour verre monolithique	T	
206831-050-12	12	L = 5 m
206831-050-15	15	L = 5 m
206831-050-19	19	L = 5 m

Pour verre feuilleté

206831-050-13	12,76	L = 5 m
206831-050-14	13,52	L = 5 m
206831-050-17	16,76	L = 5 m
206831-050-18	17,52	L = 5 m
206831-050-21	20,76	L = 5 m
206831-050-22	21,52	L = 5 m

NEW

Q-INFO

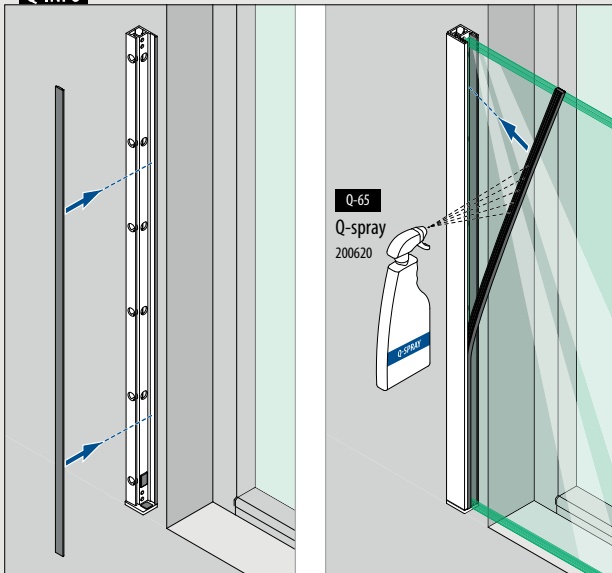

Embouts pour MOD 6830 / 6839



Bas
Avec verr. de sécurité

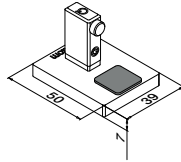

MOD 6832

Aluminium Brut	
166832-01-00	2
Aluminium Brossé, anodisé	
OUTDOOR	
166832-01-18	2



International Design Modèle Protection



Haut

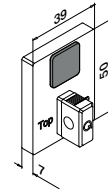

MOD 6832 - EASY HIT®

Aluminium Brut	
166832-02-00	2
Aluminium Brossé, anodisé	
OUTDOOR	
166832-02-18	2



International Design Modèle Protection

Embouts pour MOD 6840 / 6849



Bas
Centre

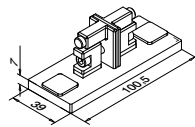

MOD 6842

Aluminium Brut	
166842-01-00	2
Aluminium Brossé, anodisé	
OUTDOOR	
166842-01-18	2



International Design Modèle Protection



Haut
Centre

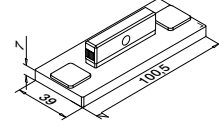

MOD 6842 - EASY HIT®

Aluminium Brut	
166842-02-00	2
Aluminium Brossé, anodisé	
OUTDOOR	
166842-02-18	2



International Design Modèle Protection

Caches

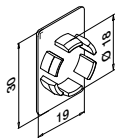

MOD 6838

Plastique Aluminium blanc RAL 9006	
OUTDOOR	
156838-36	4

Q-INFO Aluminium

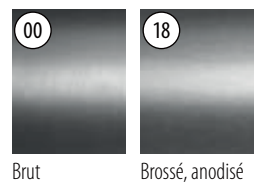

Q-INFO MOD 6832-01

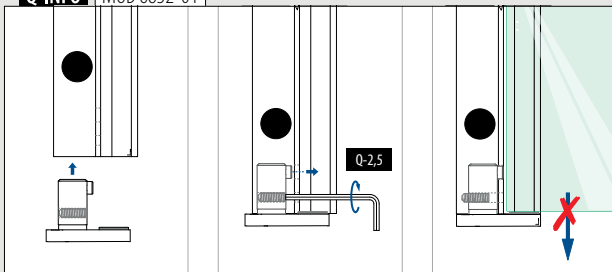

Q-INFO MOD 6842-01

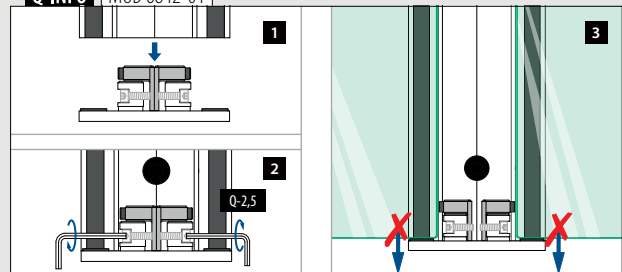



Conçu pour : Utilisation faible à moyenne
Utilisation : Intérieur et extérieur
Variantes : Montage mural (façade)
Applications : Protection de fenêtres
Matériau : Aluminium (brossé anodisé et brut), inox brossé
Épaisseur de verre : 8 à 21,52 mm

Retrouvez toutes les informations sur Easy Glass MOD 6507-6508 en ligne :



<https://q-ne.ws/6507-6508-23>

EASY GLASS® MOD 6507-6508



Balcons à la française élégants et polyvalents

Les balcons à la française Easy Glass® MOD 6507-6508 sont minimalistes, mais constituent des protections anti-chute efficaces sur les fenêtres s'élevant du sol au plafond. Le remplissage en verre s'installe facilement sur la façade à l'aide d'embases murales et de tubes à fond de gorge. Quant aux composants de garde-corps, vous avez le choix entre des formes rondes ou carrées.

Tests/calculs/certificats internationaux:



- 1 Les tubes à fond de gorge se posent sur la façade, à l'horizontale ou la verticale.
- 2 Easy Glass MOD 6507-6508 habille n'importe quelle façade avec style.



DÉCLINAISONS DE **EASY GLASS® MOD 6507-6508**

- Montage mural avec ancrages chimiques
- Montage horizontal et vertical

Montage en façade
rond

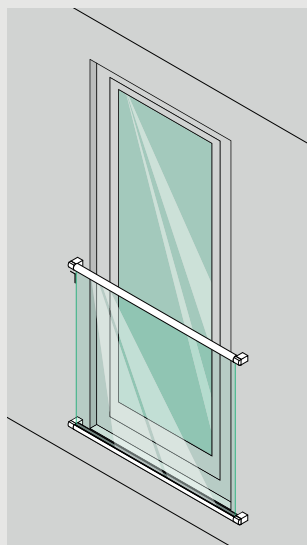

Montage en façade
carré

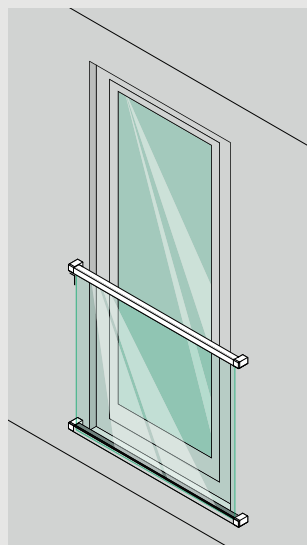

Easy Glass® MOD 6507

Montage en façade

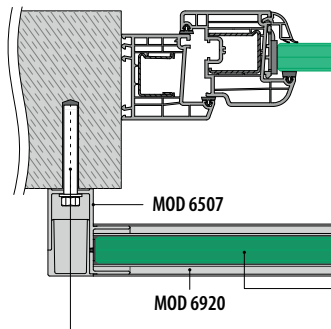

Montage sur cadre

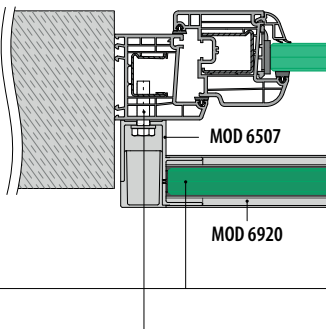

Merci de prendre en considération les spécifications de chaque certificat telles qu'épaisseur du verre, fixation et types de verre.

Verre de sécurité : 160 - 161

Fixations : 457 - 463

Embases murales pour tube

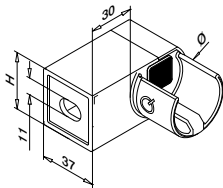

MOD 6507

316 Inox brossé

OUTDOOR

Pour Ø

H



SELL OUT

146507-042-01

42,4

37

457 - 463

2



International Design Modèle Protection

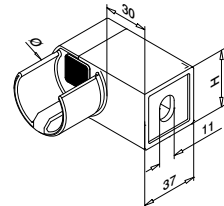

MOD 6507

316 Inox brossé

OUTDOOR

Pour Ø

H



SELL OUT

146507-042-02

42,4

37

457 - 463

2



International Design Modèle Protection

Tubes à fond de gorge

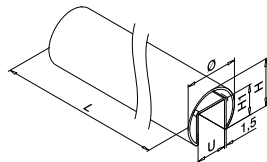

MOD 6920

316 Inox brossé

OUTDOOR

U

Ø

H

H1



146920-042-50-12

24

42,4

37

24

L = 5 m

Joint pour fond de gorge

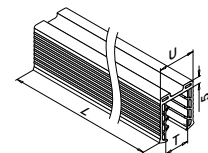

MOD 5124

Accessoires

U = 24 mm

Pour verre monolithique

T



205124-050-08

8 - 10

L = 5 m

205124-050-11

12

L = 5 m

205124-050-15

15

L = 5 m

205124-050-19

19

L = 5 m

Pour verre feuilleté

205124-050-08

8,76 - 10,76

L = 5 m

205124-050-11

11,52 - 13,52

L = 5 m

205124-050-17

16,76 - 17,52

L = 5 m

NEW

205124-050-92

20,76 - 21,52

L = 5 m

Q-INFO

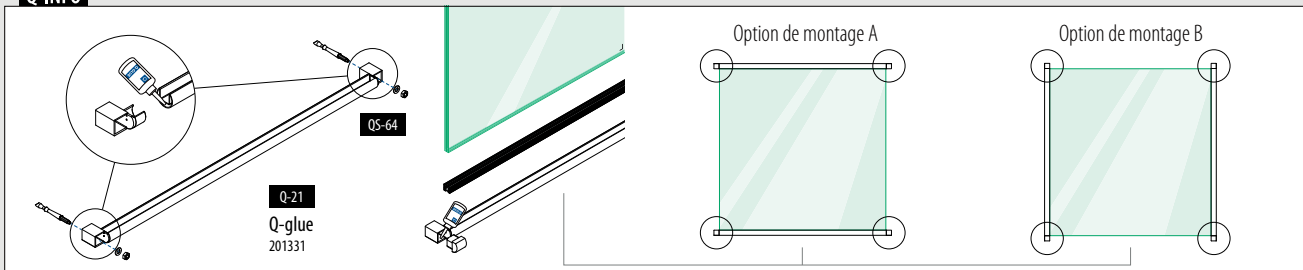

Embases murales pour tube

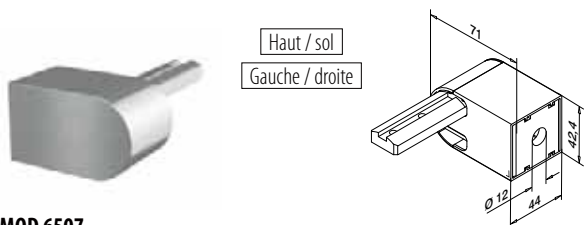

MOD 6507

Aluminium	Brut		
166507-042-00-00	42,4	457 - 463	2
Aluminium	Brossé, anodisé		
OUTDOOR			
166507-042-00-18	42,4	457 - 463	2

NEW

Tubes à fond de gorge

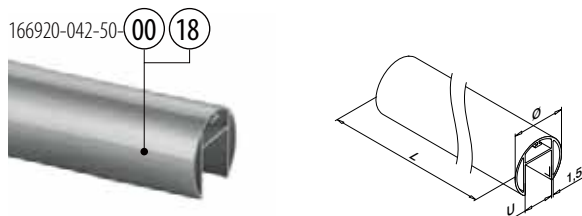

MOD 6920

Aluminium	Brut		
166920-042-50-00	24	42,4	L = 5 m
Aluminium	Brossé, anodisé		
OUTDOOR			
166920-042-50-18	24	42,4	L = 5 m



International Design Modèle Protection

Joint pour fond de gorge



MOD 5124

Accessoires		
U = 24 mm		
Pour verre monolithique	T	
205124-050-08	8 - 10	L = 5 m
205124-050-11	12	L = 5 m
205124-050-15	15	L = 5 m
205124-050-19	19	L = 5 m

Pour verre feuilleté		
205124-050-08	8,76 - 10,76	L = 5 m
205124-050-11	11,52 - 13,52	L = 5 m
205124-050-17	16,76 - 17,52	L = 5 m
NEW 205124-050-92	20,76 - 21,52	L = 5 m

Q-INFO MOD 6920

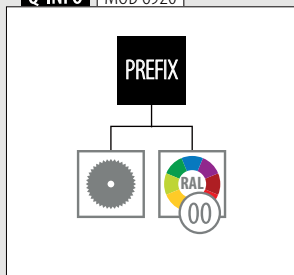

Q-INFO Aluminium

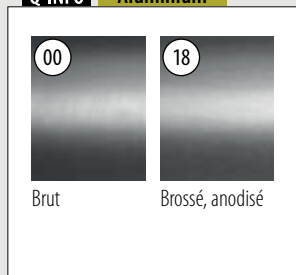

Q-INFO

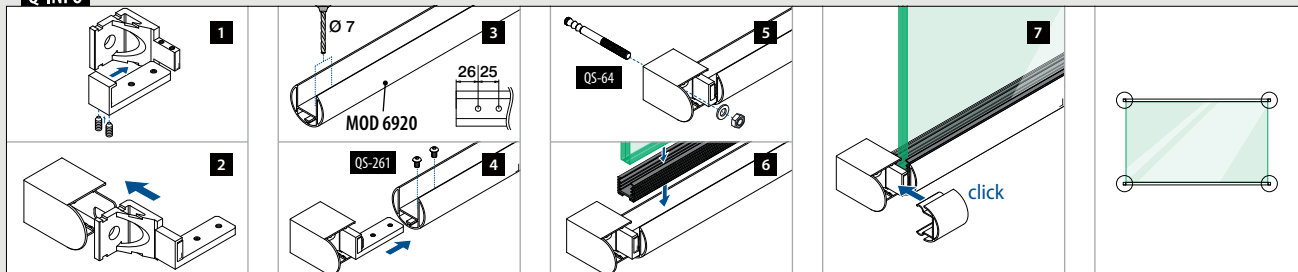

Montage en façade

Montage sur cadre

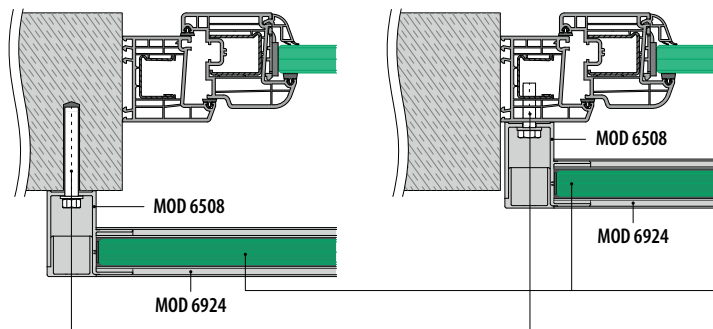

Merci de prendre en considération les spécifications de chaque certificat telles qu'épaisseur du verre, fixation et types de verre.

Verre de sécurité : 160 - 161

Fixations : 457 - 463

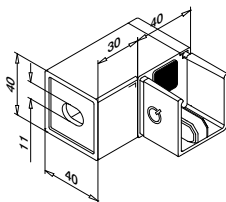

MOD 6508

316	Inox brossé	<input type="checkbox"/>		
OUTDOOR				
146508-040-01	40 x 40		457 - 463	2



International Design Modèle Protection

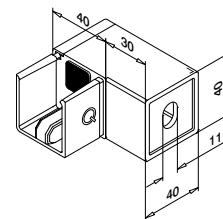

MOD 6508

316	Inox brossé	<input type="checkbox"/>		
OUTDOOR				
146508-040-02	40 x 40		457 - 463	2



International Design Modèle Protection

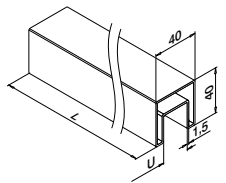

MOD 6924

316	Inox brossé	<input type="checkbox"/>		
OUTDOOR	U			
146924-040-50-12	24	40 x 40		L = 5 m

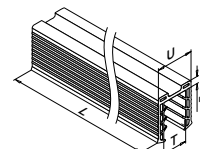

MOD 5124

Accessoires		
U = 24 mm		
Pour verre monolithique	T	
205124-050-08	8 - 10	L = 5 m
205124-050-11	12	L = 5 m
205124-050-15	15	L = 5 m
205124-050-19	19	L = 5 m

Pour verre feuilleté		
205124-050-08	8,76 - 10,76	L = 5 m
205124-050-11	11,52 - 13,52	L = 5 m
205124-050-17	16,76 - 17,52	L = 5 m
NEW 205124-050-92	20,76 - 21,52	L = 5 m

Q-INFO

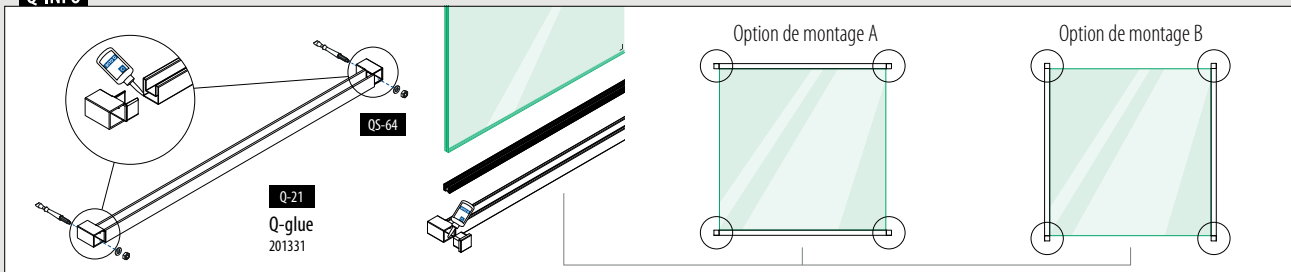

Embases murales pour tube

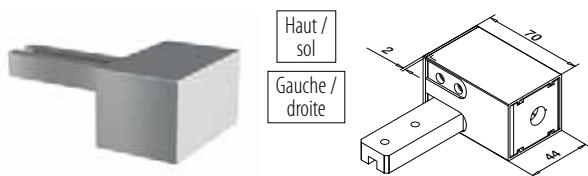

MOD 6508

Aluminium	Brossé, anodisé		
OUTDOOR			
166508-040-18	40 x 40	457 - 463	2

NEW

Tubes à fond de gorge

Carré □

166924-040-50-00 18

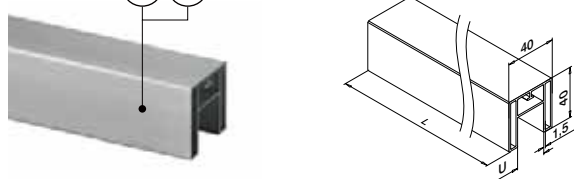

MOD 6924

Aluminium	Brut		
	U	□	
166924-040-50-00	24	40 x 40	L = 5 m
Aluminium	Brossé, anodisé		
OUTDOOR			
166924-040-50-18	24	40 x 40	L = 5 m



International Design Modèle Protection

Joint pour fond de gorge



MOD 5124

Accessoires		
U = 24 mm		
Pour verre monolithique	T	
205124-050-08	8 - 10	L = 5 m
205124-050-11	12	L = 5 m
205124-050-15	15	L = 5 m
205124-050-19	19	L = 5 m
Pour verre feuilleté		
205124-050-08	8,76 - 10,76	L = 5 m
205124-050-11	11,52 - 13,52	L = 5 m
205124-050-17	16,76 - 17,52	L = 5 m
NEW 205124-050-92	20,76 - 21,52	L = 5 m

Q-INFO MOD 6924

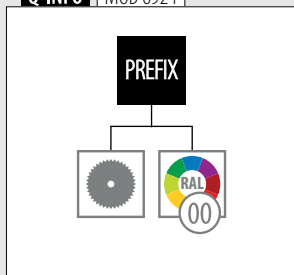

Q-INFO Aluminium

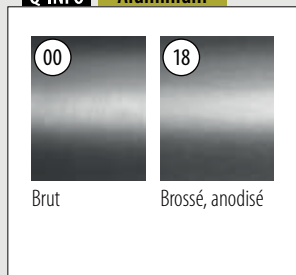

Q-INFO

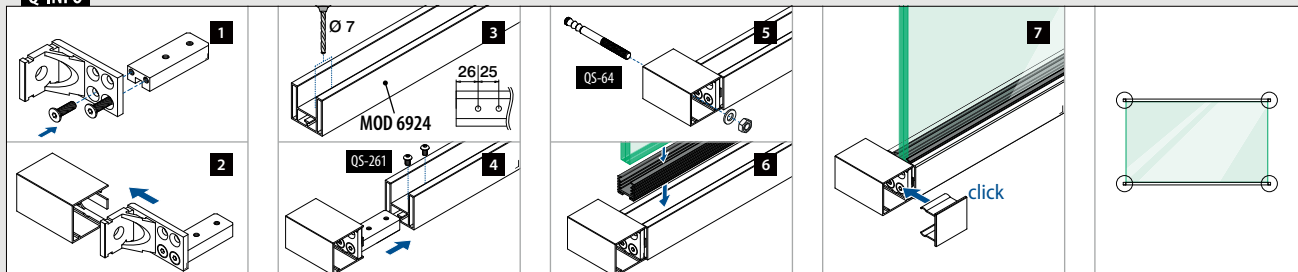

Easy Glass® MOD 6508

Montage en façade

Montage sur cadre

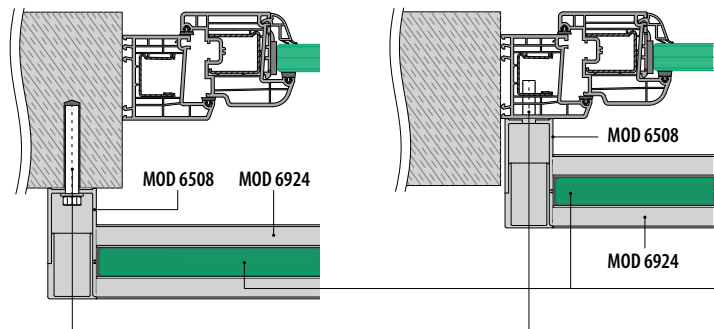

Merci de prendre en considération les spécifications de chaque certificat telles qu'épaisseur du verre, fixation et types de verre.

Verre de sécurité : 160 - 161

Fixations : 457 - 463

Embases murales pour tube

Rectangulaire

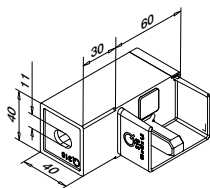

MOD 6508

316	Inox brossé			
OUTDOOR				
146508-640-01	60 x 40		457 - 463	2

NEW

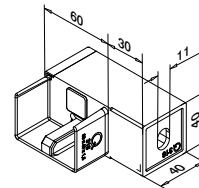

MOD 6508

316	Inox brossé			
OUTDOOR				
146508-640-02	60 x 40		457 - 463	2

NEW

Tubes à fond de gorge

Rectangulaire

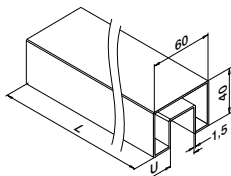

MOD 6924

316	Inox brossé			
OUTDOOR	U			
146924-640-50-12	24	60 x 40		L = 5 m

PREFIX



Jointes pour fond de gorge

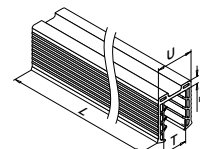

MOD 5124

Accessoires

U = 24 mm		
Pour verre monolithique	T	
205124-050-08	8 - 10	L = 5 m
205124-050-11	12	L = 5 m
205124-050-15	15	L = 5 m
205124-050-19	19	L = 5 m

Pour verre feuilleté

205124-050-08	8,76 - 10,76	L = 5 m
205124-050-11	11,52 - 13,52	L = 5 m
205124-050-17	16,76 - 17,52	L = 5 m
NEW 205124-050-92	20,76 - 21,52	L = 5 m

Q-INFO

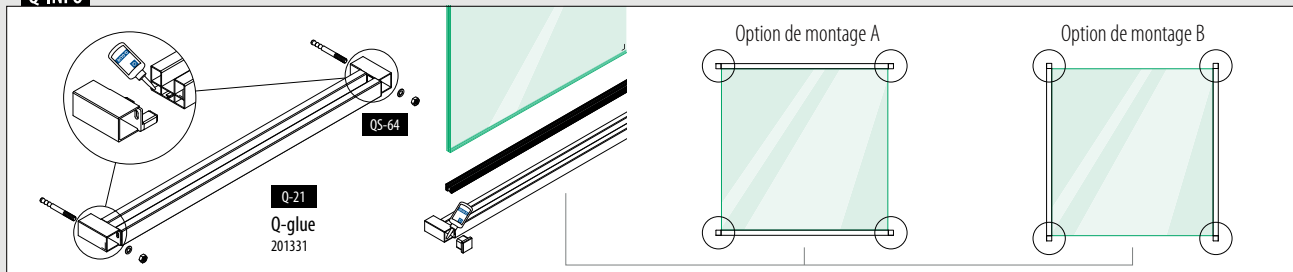

Easy Glass® MOD 6505

Montage entre murs

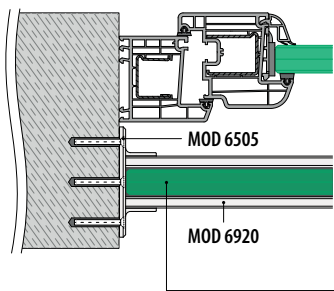

Merci de prendre en considération les spécifications de chaque certificat telles qu'épaisseur du verre, fixation et types de verre.

Verre de sécurité : 160 - 161

Tubes à fond de gorge

Embases murales pour tube

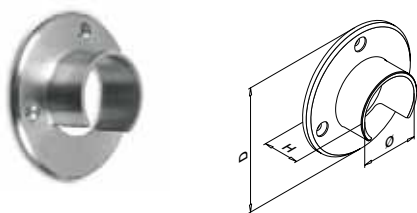

MOD 6505

316	Inox brossé					
OUTDOOR	Ø	D	H			
146505-042-12	42,4	90	30	QS-6 471	2	



Tubes à fond de gorge

Tubes à fond de gorge

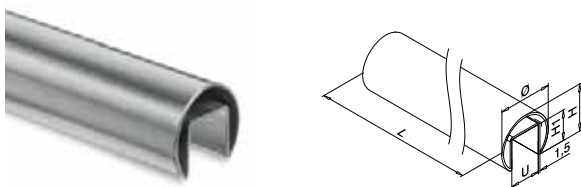

MOD 6920

316	Inox brossé					
OUTDOOR	U	Ø	H	H1		
146920-042-50-12	24	42,4	37	24	L = 5 m	



Seulement jusqu'à épuisement des stocks.

Q-INFO MOD 6920

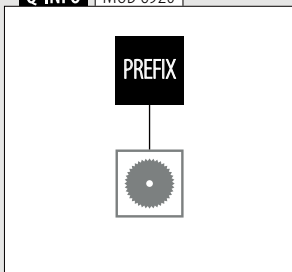

Tubes à fond de gorge

Joint pour fond de gorge



MOD 5124

Accessoires

U = 24 mm

Pour verre monolithique	T	
205124-050-08	8 - 10	L = 5 m
205124-050-11	12	L = 5 m
205124-050-15	15	L = 5 m
205124-050-19	19	L = 5 m

205124-250-08	8 - 10	L = 25 m
205124-250-11	12	L = 25 m
205124-250-15	15	L = 25 m
205124-250-19	19	L = 25 m

Pour verre feuilleté

205124-050-08	8,76 - 10,76	L = 5 m
205124-050-11	11,52 - 13,52	L = 5 m
205124-050-17	16,76 - 17,52	L = 5 m
205124-050-92	20,76 - 21,52	L = 5 m

205124-250-08	8,76 - 10,76	L = 25 m
205124-250-11	11,52 - 13,52	L = 25 m
205124-250-17	16,76 - 17,52	L = 25 m
205124-250-92	20,76 - 21,52	L = 25 m

Montage entre murs

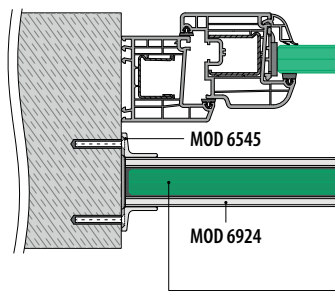

Merci de prendre en considération les spécifications de chaque certificat telles qu'épaisseur du verre, fixation et types de verre.

Verre de sécurité : 160 - 161

Embases murales pour tube

Carré □

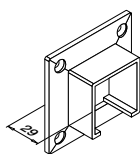
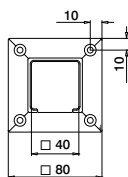

MOD 6545

316

Inox brossé

OUTDOOR



146545-040-12

40 x 40

QS-50 471

2



Tubes à fond de gorge

Carré □

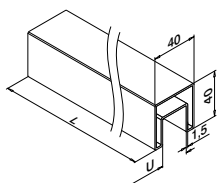

MOD 6924

316

Inox brossé

OUTDOOR

U



146924-040-50-12

24

40 x 40

L = 5 m

PREFIX



Joint pour fond de gorge

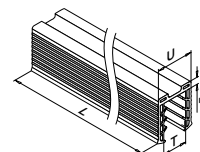

MOD 5124

Accessoires

U = 24 mm

Pour verre monolithique

T



205124-050-08

8 - 10

L = 5 m

205124-050-11

12

L = 5 m

205124-050-15

15

L = 5 m

205124-050-19

19

L = 5 m

Pour verre feuilleté

205124-050-08

8,76 - 10,76

L = 5 m

205124-050-11

11,52 - 13,52

L = 5 m

205124-050-17

16,76 - 17,52

L = 5 m

NEW

205124-050-92

20,76 - 21,52

L = 5 m

Q-INFO MOD 6924

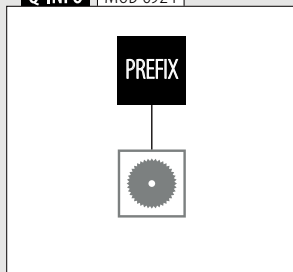

Easy Glass® MOD 6545

Montage entre murs

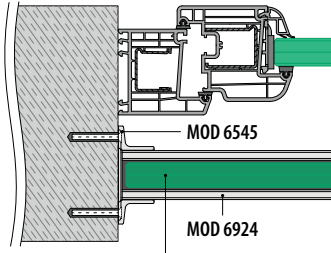

Merci de prendre en considération les spécifications de chaque certificat telles qu'épaisseur du verre, fixation et types de verre.

Verre de sécurité : 160 - 161

Embases murales pour tube

Rectangulaire

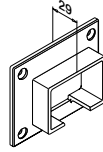
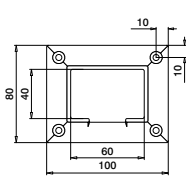

MOD 6545

316	Inox brossé			
OUTDOOR	<input type="checkbox"/>			
146545-640-12	60 x 40	QS-50 471	2	



Tubes à fond de gorge

Rectangulaire

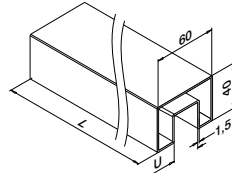

MOD 6924

316	Inox brossé			
OUTDOOR	<input type="checkbox"/>	<input type="checkbox"/>		
146924-640-50-12	24	60 x 40	L = 5 m	



Q-INFO | MOD 6924

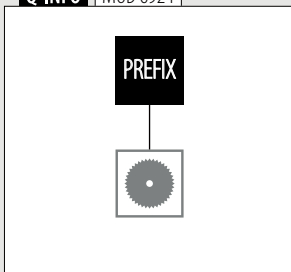

Montage entre murs

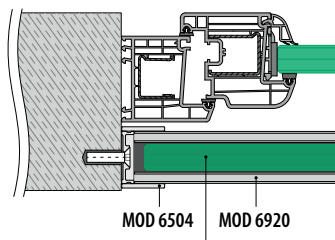

Merci de prendre en considération les spécifications de chaque certificat telles qu'épaisseur du verre, fixation et types de verre.

Verre de sécurité : 160 - 161

Embases murales pour tube

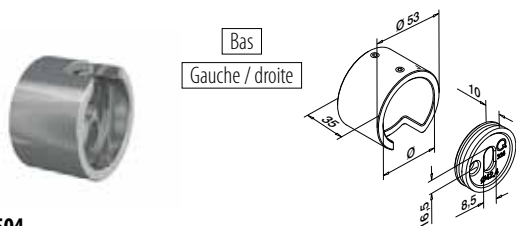

MOD 6504

Aluminium	Brut	Ø	
166504-042-00-00		42,4	2
Aluminium	Brossé, anodisé		
166504-042-00-18		42,4	2

NEW

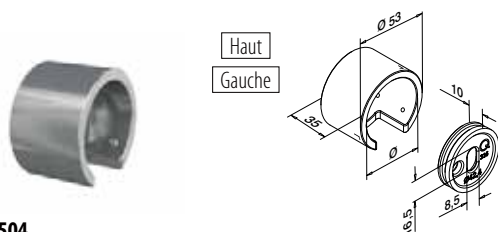

MOD 6504

Aluminium	Brut	Ø	
166504-042-01-00		42,4	2
Aluminium	Brossé, anodisé		
166504-042-01-18		42,4	2

NEW

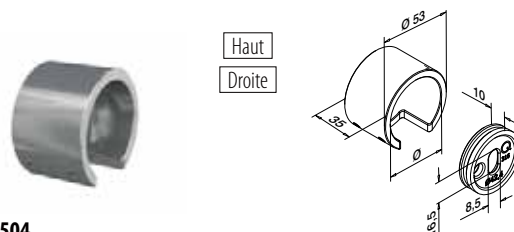

MOD 6504

Aluminium	Brut	Ø	
166504-042-02-00		42,4	2
Aluminium	Brossé, anodisé		
166504-042-02-18		42,4	2

NEW

Q-INFO Aluminium

00

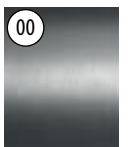

Brut

18

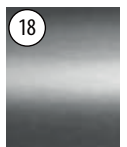

Brossé, anodisé

Tubes à fond de gorge

166920-042-50-00 18

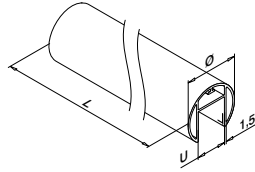

MOD 6920

Aluminium Brut

	U	Ø	
166920-042-50-00	24	42,4	L = 5 m

Aluminium Brosé, anodisé

	U	Ø	
166920-042-50-18	24	42,4	L = 5 m

PREFIX



International Design Modèle Protection

Joint pour fond de gorge

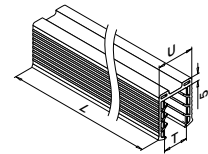

MOD 5124

Accessoires

U = 24 mm

Pour verre monolithique		T	
205124-050-08	8 - 10		L = 5 m
205124-050-11	12		L = 5 m
205124-050-15	15		L = 5 m
205124-050-19	19		L = 5 m

205124-250-08	8 - 10	L = 25 m
205124-250-11	12	L = 25 m
205124-250-15	15	L = 25 m
205124-250-19	19	L = 25 m

SELL OUT
SELL OUT

Pour verre feuilleté

205124-050-08	8,76 - 10,76	L = 5 m
205124-050-11	11,52 - 13,52	L = 5 m
205124-050-17	16,76 - 17,52	L = 5 m
NEW 205124-050-92	20,76 - 21,52	L = 5 m

205124-250-08	8,76 - 10,76	L = 25 m
205124-250-11	11,52 - 13,52	L = 25 m
205124-250-17	16,76 - 17,52	L = 25 m
NEW 205124-250-92	20,76 - 21,52	L = 25 m

Q-INFO MOD 6920

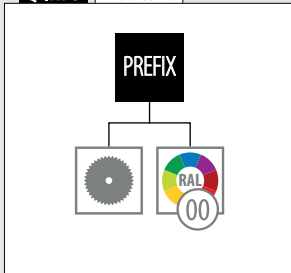

Q-INFO

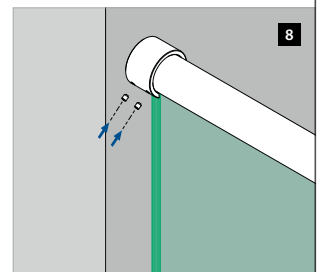
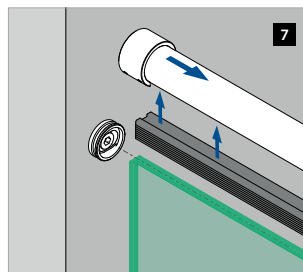
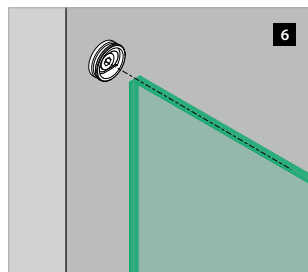
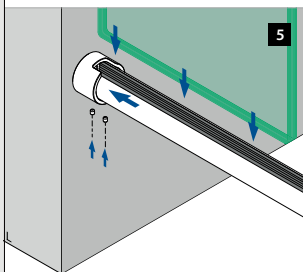
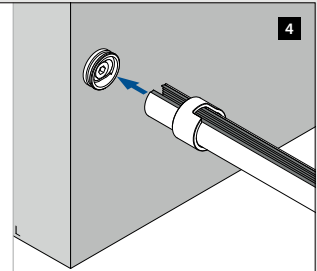
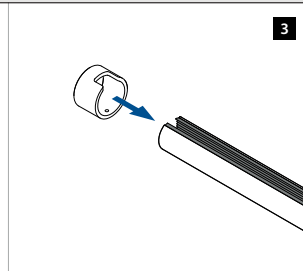
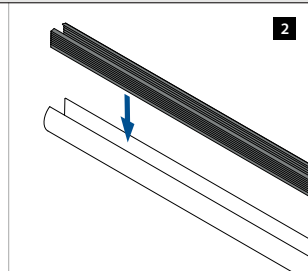
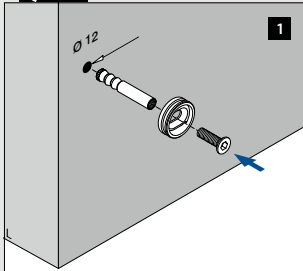



PROTECTION DE FENÊTRES AVEC PINCES À VERRE



Pincès à verre - MOD 2300

Montage entre murs

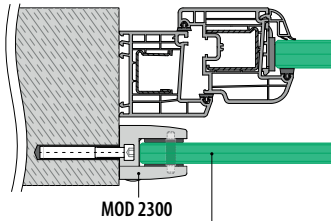

Merci de prendre en considération les spécifications de chaque certificat telles qu'épaisseur du verre, fixation et types de verre.

Verre de sécurité : ■ 160 - 161

Pincès à verre - MOD 2300

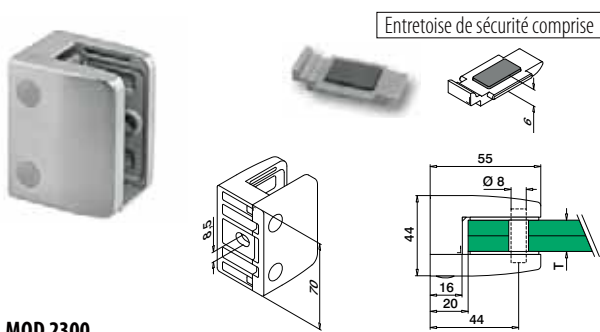

MOD 2300

316 Inox brossé

OUTDOOR	T	Q5-27	■ 472	4
142300-000-12	Voir T en MOD 5023			



Cales caoutchouc pour MOD 2300



MOD 5023

Accessoires

Pour verre monolithique		T	■
NEW	205023-12	12	8
NEW	205023-15	15	8
	205023-19	19	8

Pour verre feuilleté

NEW	205023-44	9,52	8
NEW	205023-54	11,52	8
NEW	205023-13	12,76	8
NEW	205023-64	13,52	8
NEW	205023-17	16,76	8
NEW	205023-18	17,52	8
	205023-21	20,76	8
	205023-22	21,52	8

Goupilles de sécurité

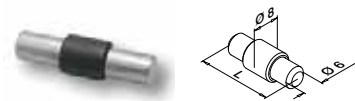

Optionnel pour MOD 2300

MOD 5015

Accessoires

		L	■
	205015-23	34	4

Q-INFO MOD 2300

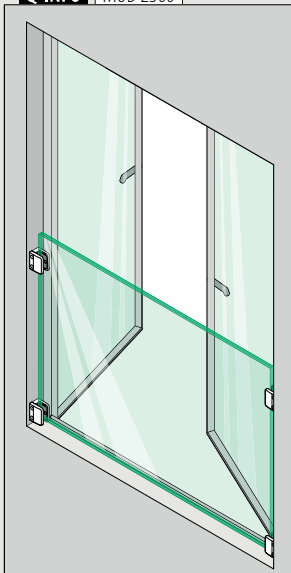

Q-INFO MOD 2300



Insérez l'entretoise de sécurité dans la pince à verre au lieu d'utiliser une goupille de sécurité. Vos frais sont réduits car il est inutile de percer le verre.

Q-INFO MOD 5015

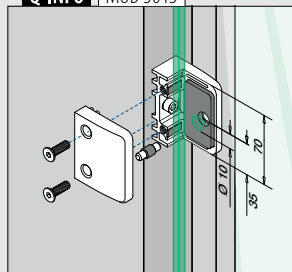

Commander séparément le matériel de fixation.



PROTECTION DE FENÊTRES AVEC ADAPTATEURS À VERRE

Montage en façade

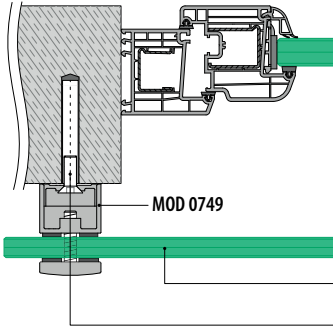

Merci de prendre en considération les spécifications de chaque certificat telles qu'épaisseur du verre, fixation et types de verre.

Verre de sécurité : 160 - 161
Fixations : 457 - 463

Adaptateurs à verre
Adaptateurs à verre **Orientables** **Ø 50**

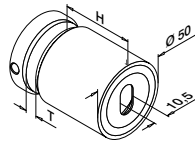

MOD 0749

316		Inox brossé			
OUTDOOR	H	T			
140749-030-12	30	12 - 25,52	457 - 463	2	
140749-040-12	40	8 - 25,52	457 - 463	2	
140749-050-12	50	8 - 25,52	457 - 463	2	
140749-100-12	100	8 - 25,52	457 - 463	2	
316		Black Line			
OUTDOOR	H	T			
NEW 140749-030-82	30	12 - 25,52	457 - 463	2	
NEW 140749-040-82	40	8 - 25,52	457 - 463	2	
NEW 140749-050-82	50	8 - 25,52	457 - 463	2	



Accessoires

Cales caoutchouc pour adaptateurs à verre

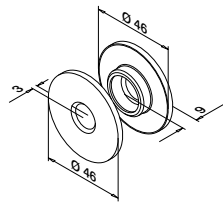

MOD 5030

Accessoires		Pour MOD	
205030-150-99-80	0749		4

NEW

Q-INFO

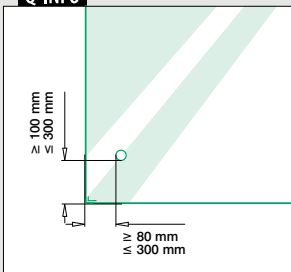

Q-INFO



Q-INFO



Adaptateurs à verre

Easy Glass® MOD 0747

Montage en façade

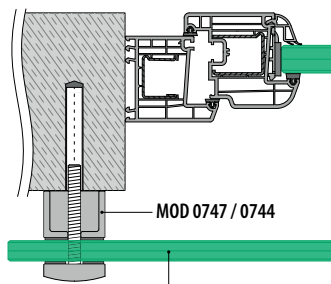

Merci de prendre en considération les spécifications de chaque certificat telles qu'épaisseur du verre, fixation et types de verre.

Verre de sécurité : 160 - 161

Adaptateurs à verre

Adaptateurs à verre

Ø 50

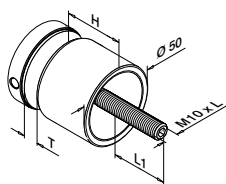

MOD 0747

316		Inox brossé				
OUTDOOR	H	T	L	L1		
140747-010-12	10	8 - 17,52	50	11 - 20	2	
140747-020-12	20	8 - 25,52	70	13 - 31	2	
140747-030-12	30	8 - 25,52	80	13 - 31	2	
140747-040-12	40	8 - 17,52	80	11 - 21	2	
140747-050-12	50	8 - 17,52	90	11 - 21	2	

316		Black Line				
OUTDOOR	H	T	L	L1		
NEW 140747-010-82	10	8 - 17,52	50	11 - 20	2	
NEW 140747-030-82	30	8 - 25,52	80	13 - 31	2	

Zamak		Aspect inox brossé				
OUTDOOR	H	T	L	L1		
SELL OUT 100747-20	10	8 - 17,52	50	11 - 20	2	

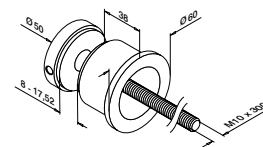

MOD 0744

316		Inox brossé				
OUTDOOR	H	T	L	L1		
140744-12					2	



Q-INFO MOD 0747

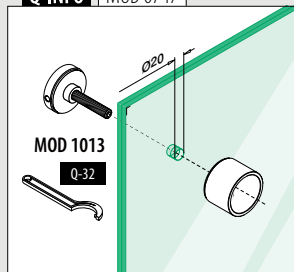

Q-INFO MOD 0747

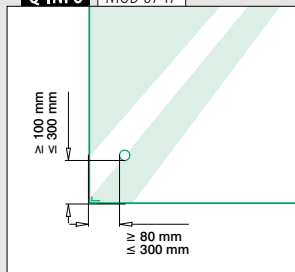

Q-INFO MOD 0744

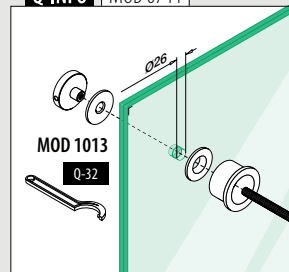

Q-INFO 316



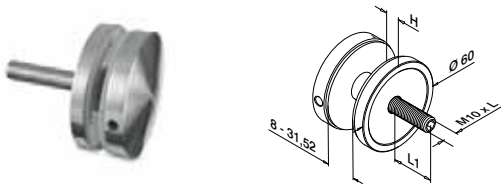

MOD 0745

316	Inox brossé				
OUTDOOR	H	L	L1		
140745-010-12	10	70	17 - 41	2	

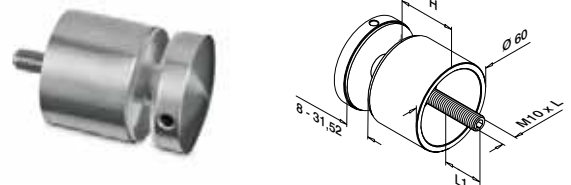

MOD 0745

316	Inox brossé				
OUTDOOR	H	L	L1		
140745-030-12	30	90	17 - 41	2	
140745-050-12	50	110	17 - 41	2	

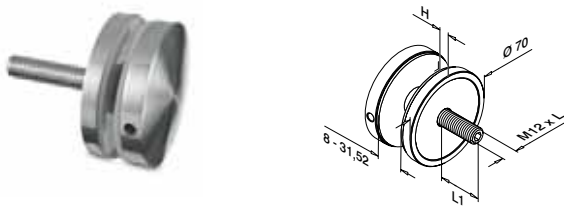

MOD 0748

316	Inox brossé				
OUTDOOR	H	L	L1		
140748-010-12	10	70	17 - 41	2	

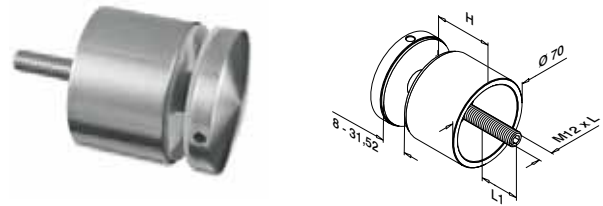

MOD 0748

316	Inox brossé				
OUTDOOR	H	L	L1		
140748-030-12	30	90	17 - 41	2	
140748-040-12	40	100	17 - 41	2	



Q-INFO MOD 0745 / 0748

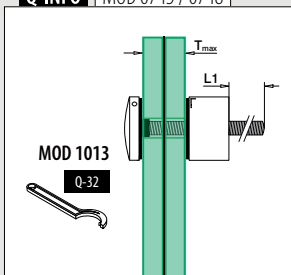

Q-INFO MOD 0745-010

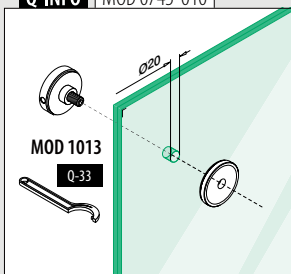

Q-INFO MOD 0745-030 / 050

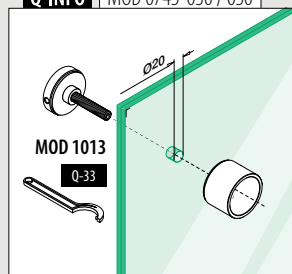

Q-INFO MOD 0748-010

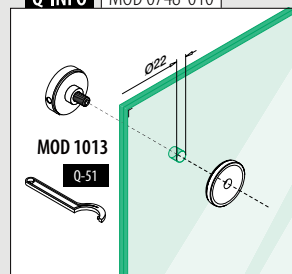

Q-INFO MOD 0748-030 / 040

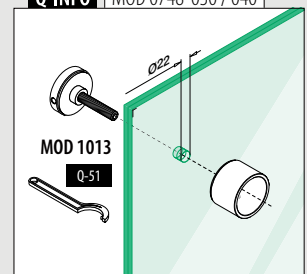

Montage en façade

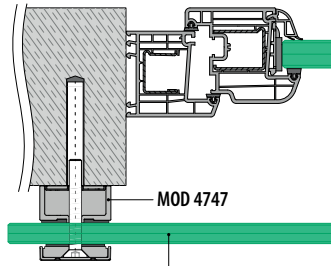

Merci de prendre en considération les spécifications de chaque certificat telles qu'épaisseur du verre, fixation et types de verre.

Verre de sécurité : 160 - 161

Adaptateurs à verre

Carré

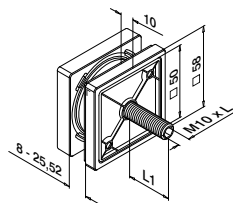

MOD 4747

316	Inox brossé		
OUTDOOR	L	L1	
144747-010-12	60	13 - 31	2



International Design Modèle Protection

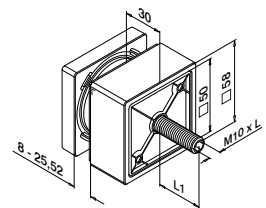

MOD 4747

316	Inox brossé		
OUTDOOR	L	L1	
144747-030-12	80	13 - 31	2



International Design Modèle Protection

Q-INFO

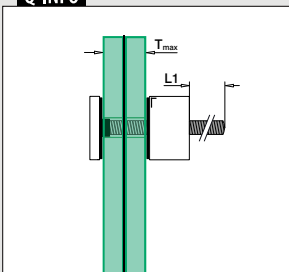

Q-INFO

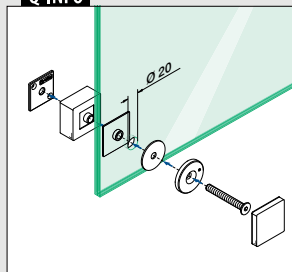

Q-INFO

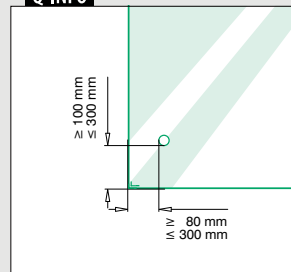

Easy Glass® MOD 0763

Montage en façade

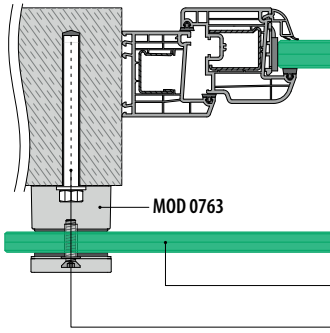

Merci de prendre en considération les spécifications de chaque certificat telles qu'épaisseur du verre, fixation et types de verre.

Verre de sécurité : 160 - 161

Fixations : 457 - 463

Adaptateurs à verre double

Rectangulaire □

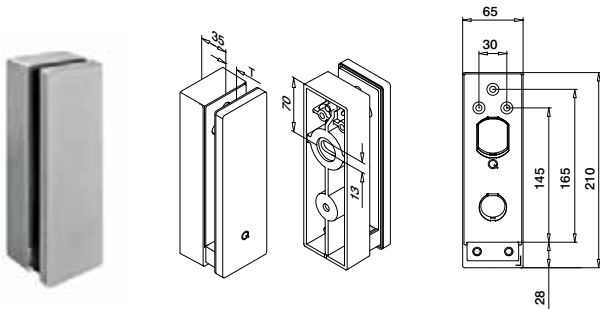

MOD 0763

316	Inox brossé		
OUTDOOR	T		
140763-12	12 - 21,52	457 - 463	1



International Design Modèle Protection

Q-INFO

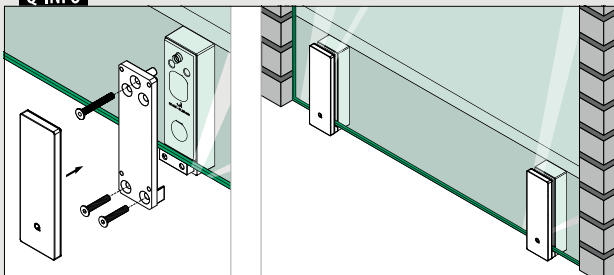

Q-INFO

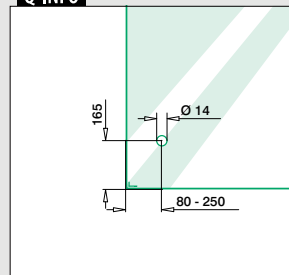



BARRES D'APPUI

Barres d'appui 20x10 - MOD 4828

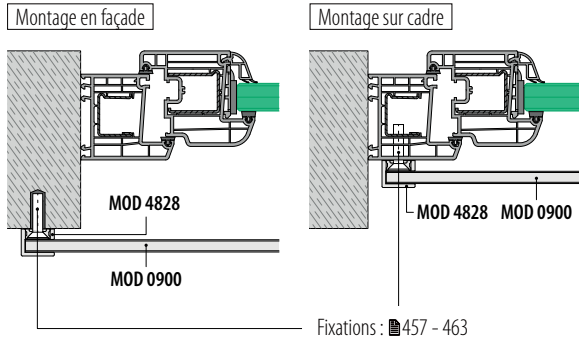

Barres d'appui 20x10 - MOD 4827

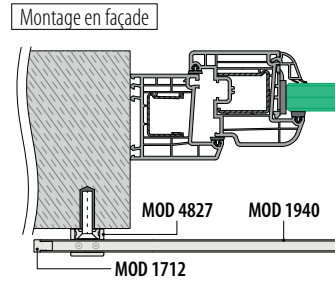

Pour les caractéristiques techniques, veuillez vous référer aux certificats techniques et autres calculs statiques concernant les détails de pose et type de fixations.

Remplissage

Supports traversants pour lisse

Rectangulaire

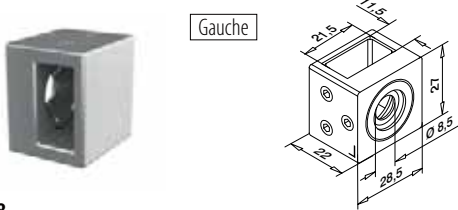

MOD 4828

316	Inox brossé			
OUTDOOR	Pour tube <input type="checkbox"/>			
144828-01-12	20 x 10 x 1,0	QS-20	4	

NEW

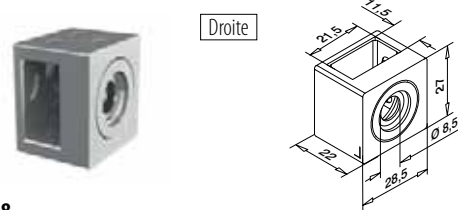

MOD 4828

316	Inox brossé			
OUTDOOR	Pour tube <input type="checkbox"/>			
144828-02-12	20 x 10 x 1,0	QS-20	4	

NEW

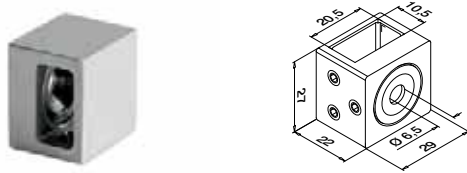

MOD 4827

316	Inox brossé			
OUTDOOR	Pour tube <input type="checkbox"/>			
144827-12	20 x 10 x 1,0	QS-16	4	



International Design Modèle Protection

Remplissage

Embouts

Rectangulaire

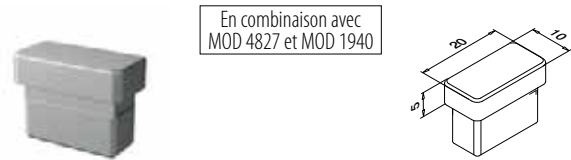

En combinaison avec MOD 4827 et MOD 1940

MOD 1712

316	Inox brossé			
OUTDOOR	Pour tube <input type="checkbox"/>			
141712-021-12	20 x 10 x 1,0		4	



International Design Modèle Protection

Mains-courantes

Tubes

Q-TUBE

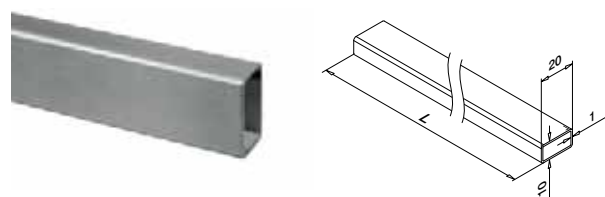

MOD 1940

316	Inox brossé			
OUTDOOR	<input type="checkbox"/>			
141940-021-50-12	20 x 10 x 1,0		L = 5 m	

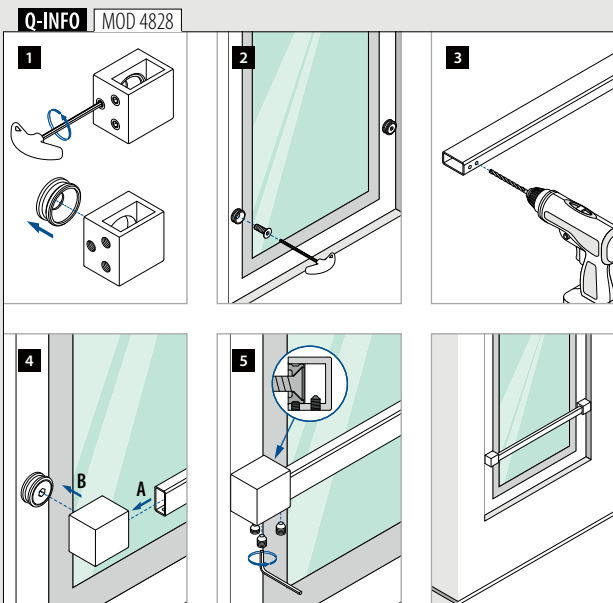

Mains-courantes

Barres d'appui 40x40 - MOD 6518

Montage en façade

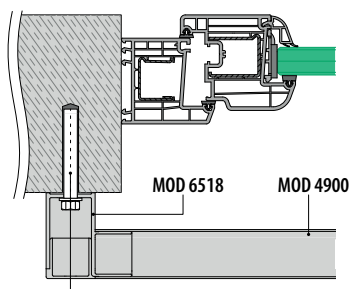

Montage sur cadre

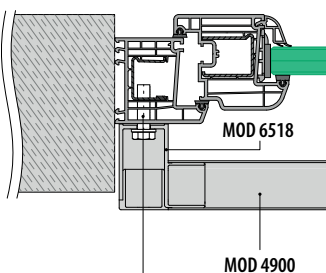

Pour les caractéristiques techniques, veuillez vous référer aux certificats techniques et autres calculs statiques concernant les détails de pose et type de fixations.

Fixations : 457 - 463

Mains-courantes

Embases murales pour tube

Carré

Gauche / droite

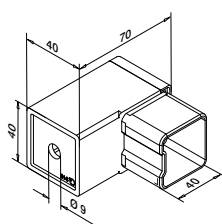

MOD 6518

316

Inox brossé

OUTDOOR

Pour tube

146518-040-12

40 x 40 x 2,0



457 - 463



2

NEW

Mains-courantes

Tubes

Q-TUBE

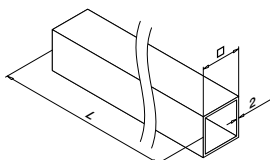

MOD 4900

316

Inox brossé

OUTDOOR

144900-040-50-12

40 x 40 x 2,0



L = 5 m

PREFIX



Q-INFO

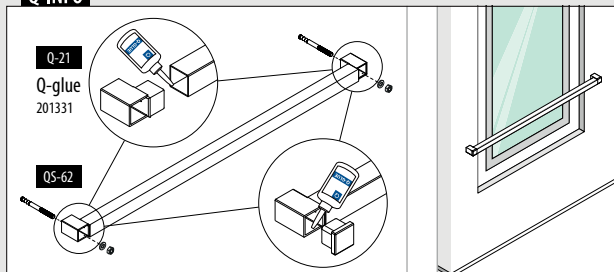

Q-INFO MOD 4900

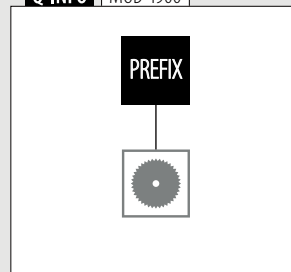

Mains-courantes

Barres d'appui 40x40 - MOD 4507

Montage en façade

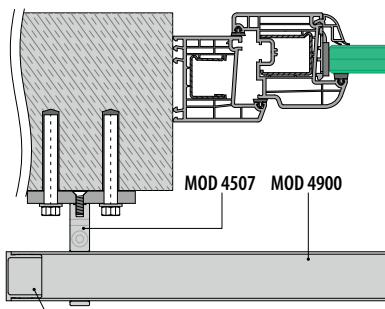

MOD 5728

Pour les caractéristiques techniques, veuillez vous référer aux certificats techniques et autres calculs statiques concernant les détails de pose et type de fixations.

Mains-courantes

Barres d'appui 40x40 - MOD 4505

Montage entre murs

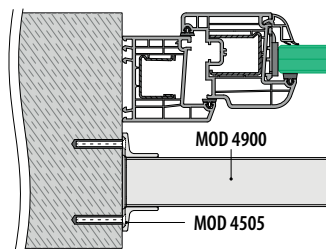

Pour les caractéristiques techniques, veuillez vous référer aux certificats techniques et autres calculs statiques concernant les détails de pose et type de fixations.

Mains-courantes

Entretoises

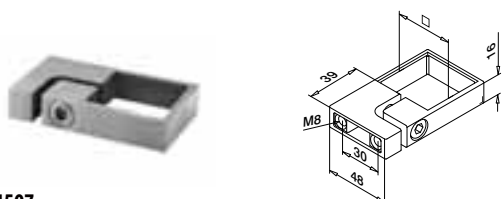

MOD 4507

316	Inox brossé		
OUTDOOR	<input type="checkbox"/>		
144507-040-12	40 x 40	QS-20	472 2



Mains-courantes

Embases murales pour tube

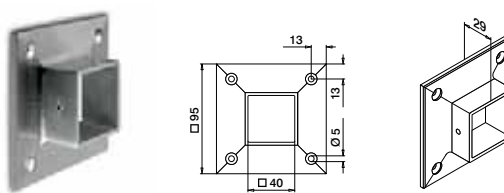

MOD 4505

316	Inox brossé		
OUTDOOR	<input type="checkbox"/>		
144505-040-12	40 x 40	QS-6	471 2



Mains-courantes

Tubes

Q-TUBE

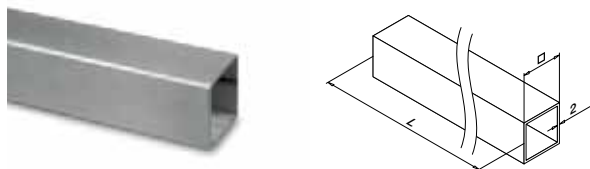

MOD 4900

316	Inox brossé		
OUTDOOR	<input type="checkbox"/>		
144900-040-50-12	40 x 40 x 2,0		L = 5 m



Mains-courantes

Embouts



En combinaison avec
MOD 4507 et MOD 4900

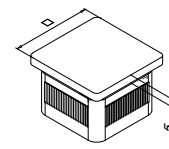

MOD 5728 - EASY HIT®

316	Inox brossé		
OUTDOOR	<input type="checkbox"/>	Pour tube	
145728-040-12	40 x 40 x 2,0		2



Q-INFO MOD 4900

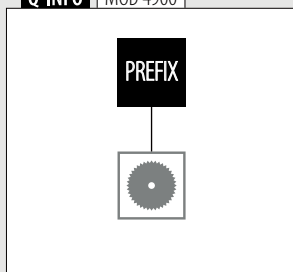

Montage en façade

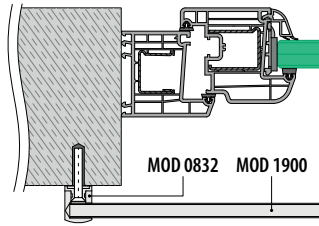

Montage sur cadre

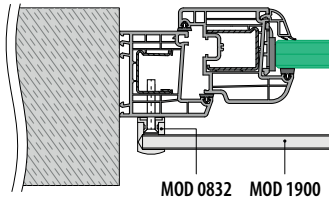

Pour les caractéristiques techniques, veuillez vous référer aux certificats techniques et autres calculs statiques concernant les détails de pose et type de fixations.

Remplissage

Supports axiaux



Gauche

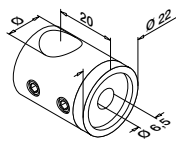

MOD 0832

316	Inox brossé			
OUTDOOR	Ø			
140832-000-12	12	QS-16	472	4



Droite

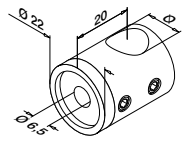

MOD 0833

316	Inox brossé			
OUTDOOR	Ø			
140833-000-12	12	QS-16	472	4

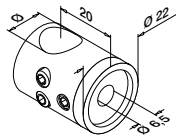

MOD 0831

316	Inox brossé			
OUTDOOR	Ø			
140831-000-12	12	QS-16	472	4



Remplissage

Embouts



En combinaison avec MOD 0831 et MOD 1900

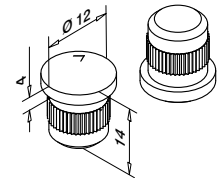

MOD 1759 - EASY HIT®

316	Inox brossé		
OUTDOOR			
141759-112-12		4	

NEW

Q-INFO MOD 1759

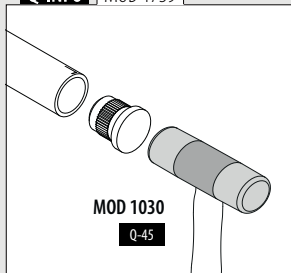

Q-INFO

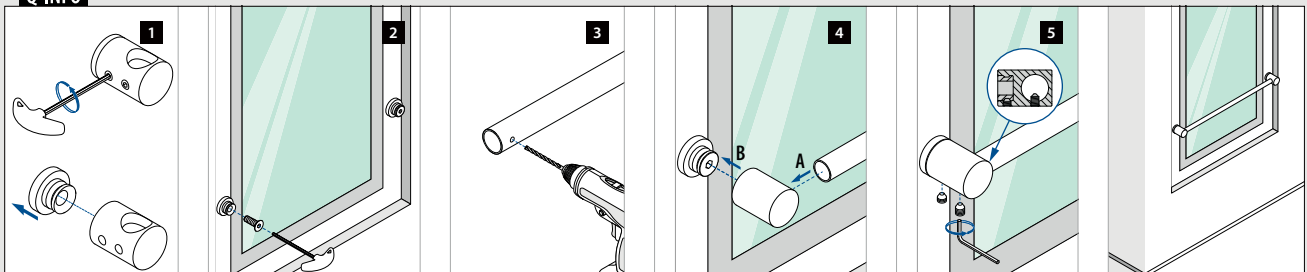

Barres d'appui Ø12 - MOD 0504

Montage entre murs

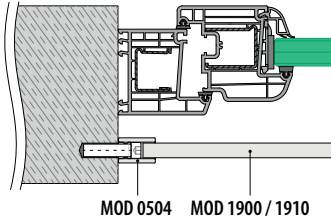

Pour les caractéristiques techniques, veuillez vous référer aux certificats techniques et autres calculs statiques concernant les détails de pose et type de fixations.

Embases murales pour tube

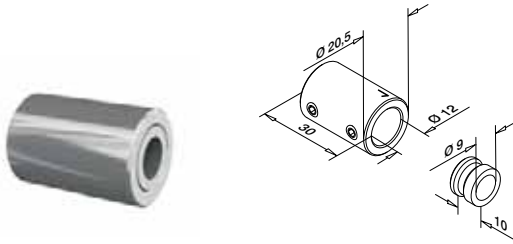

MOD 0504

316	Inox brossé		
OUTDOOR			
140504-012-12	QS-27	472	2

NEW

Barres

Q-TUBE

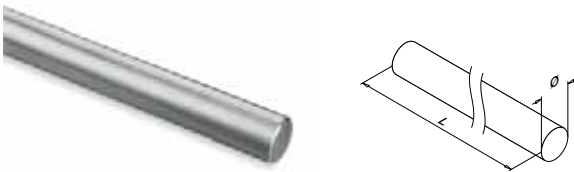

MOD 1910

316	Inox brossé		
OUTDOOR	Ø		
141910-012-25-12	12		L = 2,5 m
141910-012-50-12	12		L = 5 m

PREFIX



Tubes

Q-TUBE

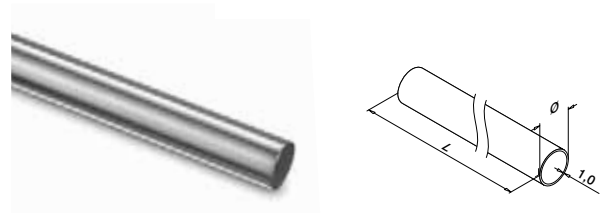

MOD 1900

316	Inox brossé		
OUTDOOR	Ø		
141900-012-50-12	12		L = 5 m

NEW

PREFIX



Q-INFO MOD 0504

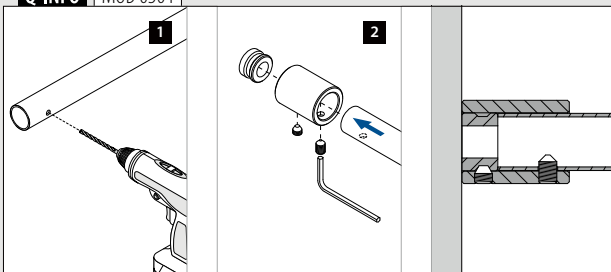

Q-INFO MOD 1900 / 1910

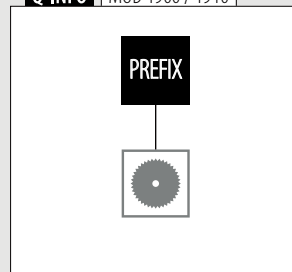

Barres d'appui Ø16 - MOD 0504

Montage entre murs

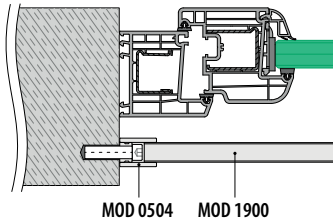

Pour les caractéristiques techniques, veuillez vous référer aux certificats techniques et autres calculs statiques concernant les détails de pose et type de fixations.

MOD 0504 MOD 1900

Embases murales pour tube

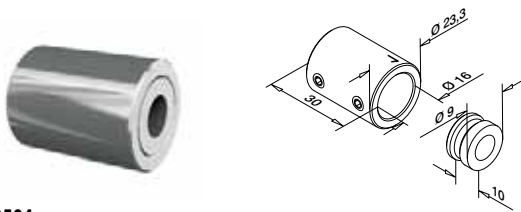

MOD 0504

316 Inox brossé

OUTDOOR

140504-016-12

QS-27 472

2

NEW

Tubes

Q-TUBE

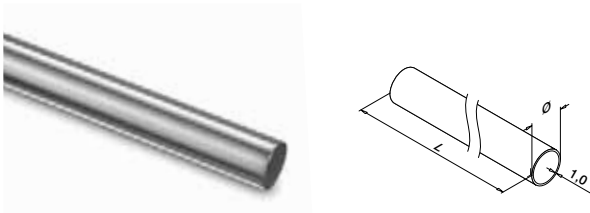

MOD 1900

316 Inox brossé

OUTDOOR

141900-016-50-12

Ø

L = 5 m

PREFIX



Q-INFO

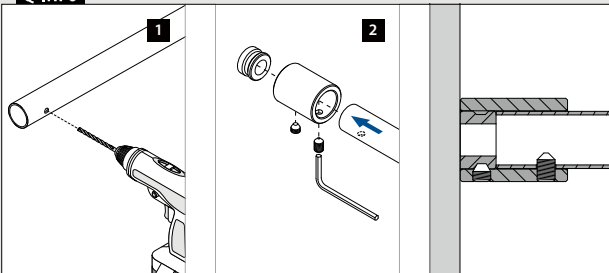

Q-INFO MOD 1900

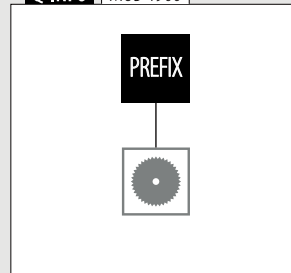

Barres d'appui Ø16 - MOD 0842 / 0843

Montage en façade

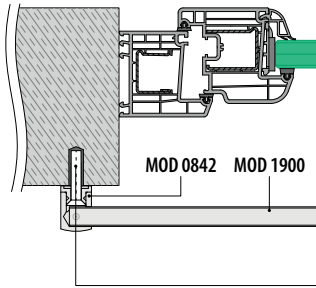

Montage sur cadre

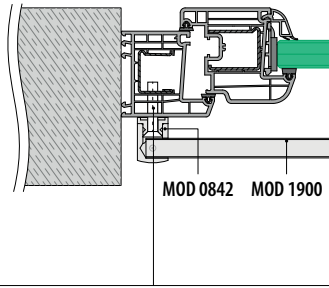

Pour les caractéristiques techniques, veuillez vous référer aux certificats techniques et autres calculs statiques concernant les détails de pose et type de fixations.

Fixations : 457 - 463

Embases murales pour tube



Gauche

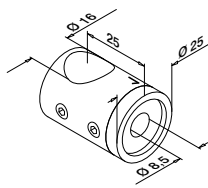

MOD 0842

316	Inox brossé		
OUTDOOR		QS-22 472	4
140842-000-12			

NEW



Droite

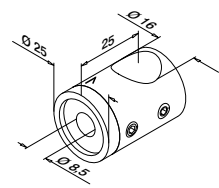

MOD 0843

316	Inox brossé		
OUTDOOR		QS-22 472	4
140843-000-12			

NEW

Tubes

Q-TUBE

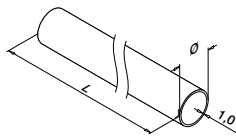

MOD 1900

316	Inox brossé	
OUTDOOR	Ø	L = 5 m
141900-016-50-12	16	

PREFIX



Embouts

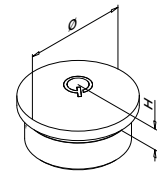

MOD 1729

316	Inox brossé	
OUTDOOR	Pour tube Ø	H
141729-016-12	16,0 x 1,0	4



Q-INFO MOD 0842 / 0843

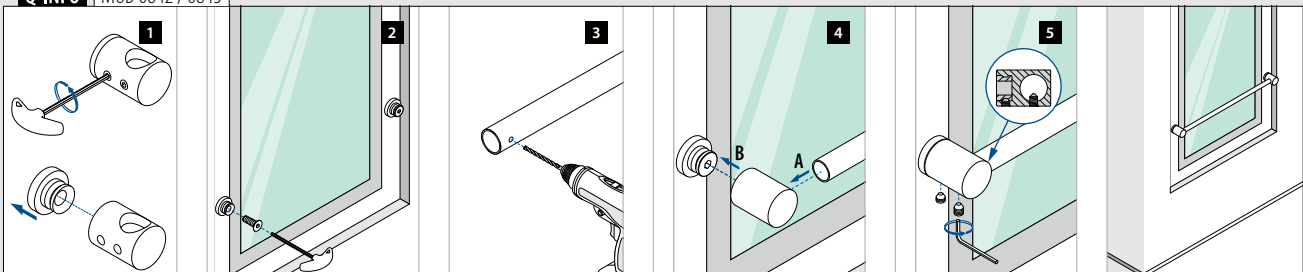

Mains-courantes

Barres d'appui Ø33,7 - MOD 0504

Montage entre murs

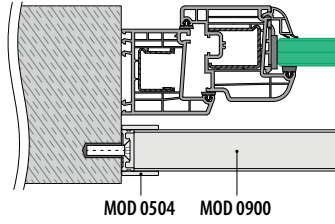

Pour les caractéristiques techniques, veuillez vous référer aux certificats techniques et autres calculs statiques concernant les détails de pose et type de fixations.

Mains-courantes

Barres d'appui Ø33,7 - MOD 0505 / 0506

Montage entre murs

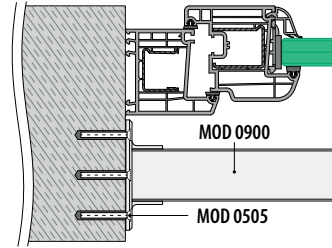

Pour les caractéristiques techniques, veuillez vous référer aux certificats techniques et autres calculs statiques concernant les détails de pose et type de fixations.

Mains-courantes

Embases murales pour tube

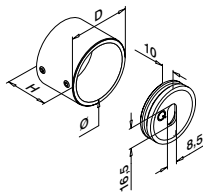

MOD 0504

316	Inox brossé						
OUTDOOR	Ø	D	H				
140504-033-12	33,7	41	30	QS-55	470 / QS-22	472	2

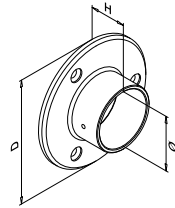

MOD 0505

316	Inox brossé						
OUTDOOR	Pour tube Ø	D	H				
140505-033-12	33,7	85	30	QS-50	471		2

NEW



Mains-courantes

Embases murales pour tube

Orientables

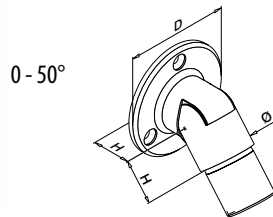

MOD 0506

316	Inox brossé						
OUTDOOR	Pour tube Ø	D	H				
140506-033-12	33,7 x 2,0	70	26	QS-50	471		2

NEW



International Design Modèle Protection

Mains-courantes

Tubes

Q-TUBE

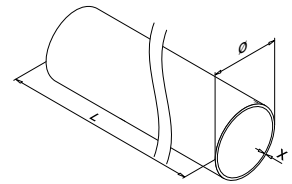

MOD 0900

316	Inox brossé						
OUTDOOR	Ø	X					
140900-233-50-12	33,7	2,0				L = 5 m	

PREFIX



Q-INFO | MOD 0504

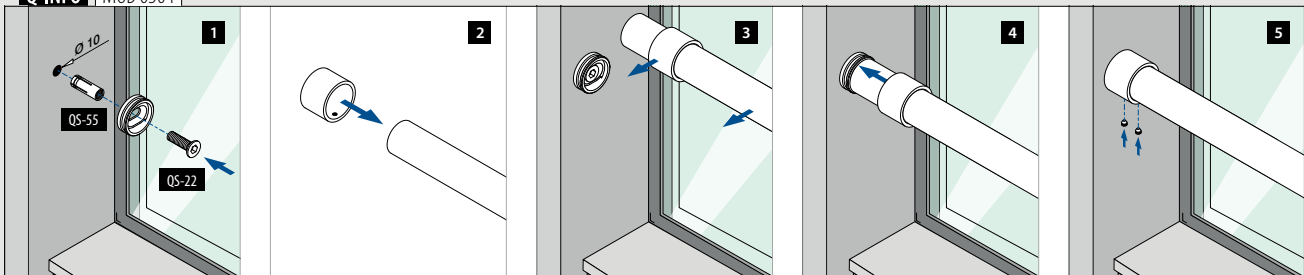

Barres d'appui Ø33,7 - MOD 6517

Montage en façade

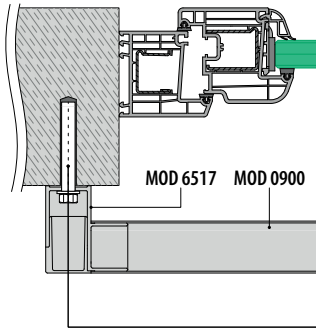

Montage sur cadre

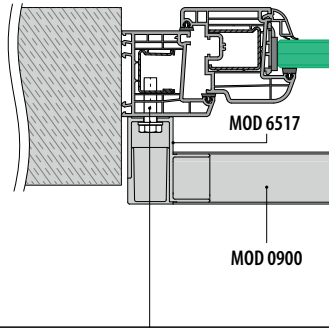

Pour les caractéristiques techniques, veuillez vous référer aux certificats techniques et autres calculs statiques concernant les détails de pose et type de fixations.

Fixations : 457 - 463

Embases murales pour tube

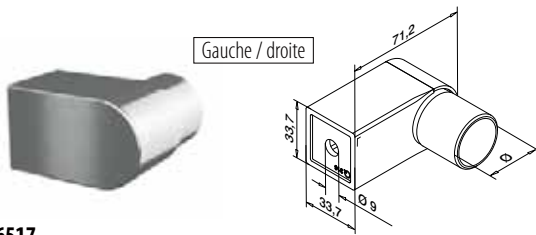

MOD 6517

316	Inox brossé			
OUTDOOR	Pour tube Ø			
146517-233-12	33,7 x 2,0	QS-27 472	2	

NEW

Tubes

Q-TUBE

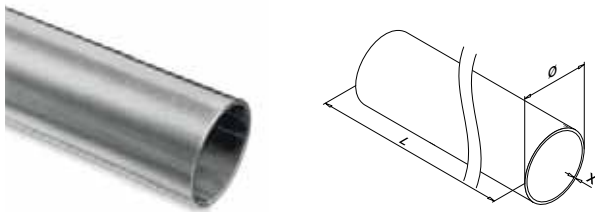

MOD 0900

316	Inox brossé			
OUTDOOR	Ø	X		
140900-233-50-12	33,7	2,0	L = 5 m	



Q-INFO

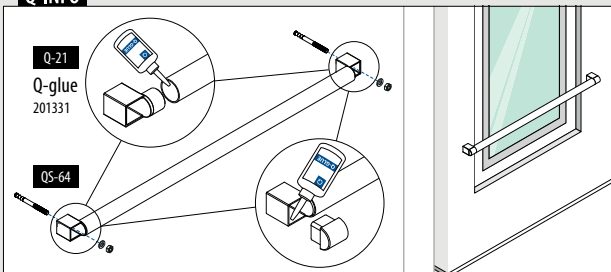

Q-INFO MOD 0900

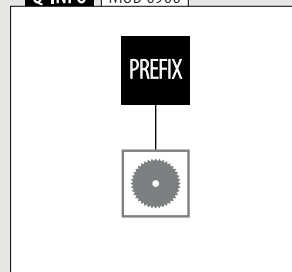

Barres d'appui Ø33,7 - MOD 0523

Montage en façade

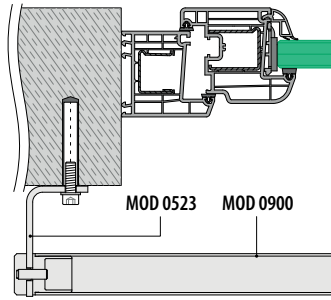

Pour les caractéristiques techniques, veuillez vous référer aux certificats techniques et autres calculs statiques concernant les détails de pose et type de fixations.

Embases murales pour tube

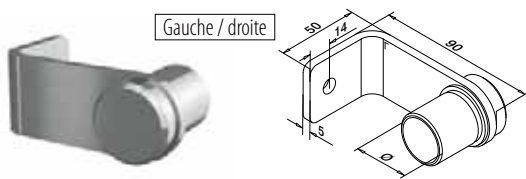

MOD 0523

316	Inox brossé		
OUTDOOR	Pour tube Ø		
140523-033-12	33,7 x 2,0	QS-30 472	2

NEW

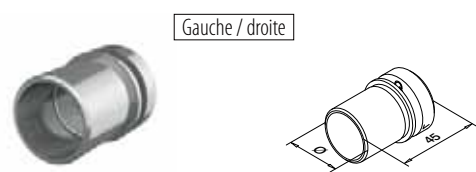

MOD 3523

316	Inox brossé		
OUTDOOR	Pour tube Ø		
143523-033-12	33,7 x 2,0		2

NEW

Tubes

Q-TUBE

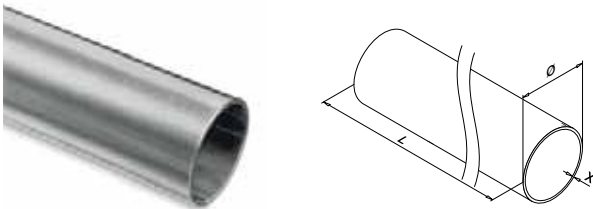

MOD 0900

316	Inox brossé		
OUTDOOR	Ø	X	
140900-233-50-12	33,7	2,0	L = 5 m

PREFIX



Q-INFO MOD 0523

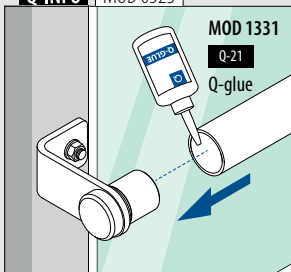

Q-INFO MOD 0900

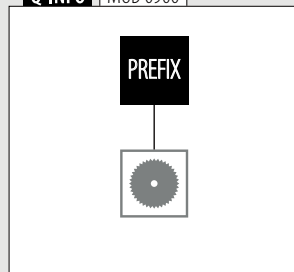

Barres d'appui Ø42,4 - MOD 0504

Montage entre murs

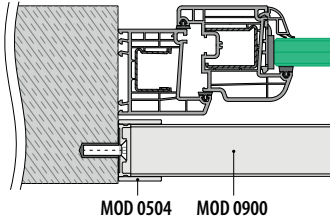

Pour les caractéristiques techniques, veuillez vous référer aux certificats techniques et autres calculs statiques concernant les détails de pose et type de fixations.

Barres d'appui Ø42,4 - MOD 0505

Montage entre murs

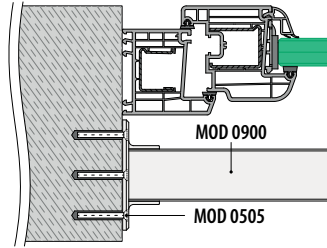

Pour les caractéristiques techniques, veuillez vous référer aux certificats techniques et autres calculs statiques concernant les détails de pose et type de fixations.

Embases murales pour tube

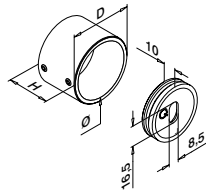

MOD 0504

316	Inox brossé					
OUTDOOR	Ø	D	H			
140504-042-12	42,4	50	35	QS-55	470 / QS-22	472 2

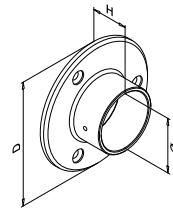

MOD 0505

316	Inox brossé					
OUTDOOR	Pour tube Ø	D	H			
140505-042-12	42,4	95	30	QS-50	471	2



Embases murales pour tube

Orientables



0 - 50°

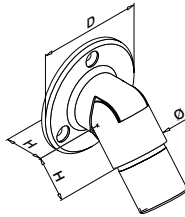

MOD 0506

316	Inox brossé					
OUTDOOR	Pour tube Ø	D	H			
140506-042-12	42,4 x 2,0	75	30	QS-50	471	2

NEW



International Design Modèle Protection

Tubes

Q-TUBE

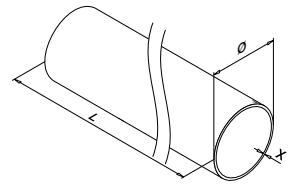

MOD 0900

316	Inox brossé				
OUTDOOR	Ø	X			
140900-242-50-12	42,4	2,0			L = 5 m



Q-INFO MOD 0504

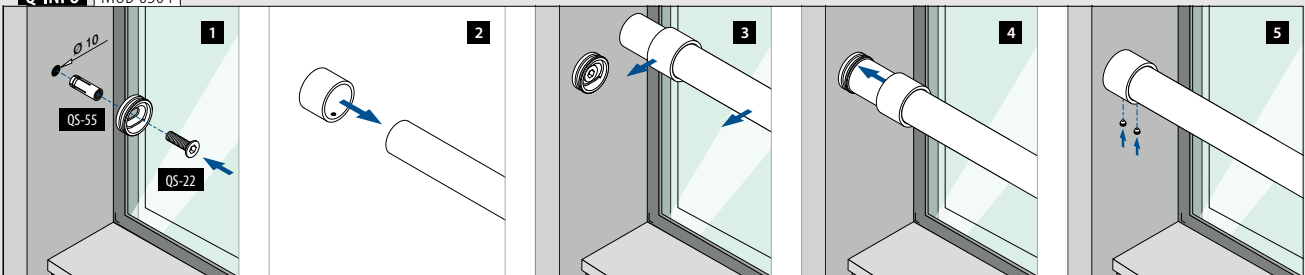

Mains-courantes

Barres d'appui Ø42,4 - MOD 6517

Montage en façade

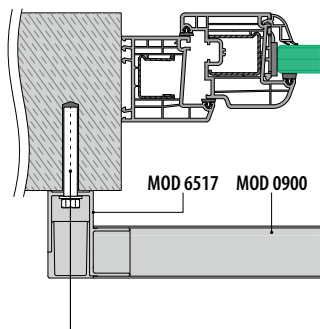

Montage sur cadre

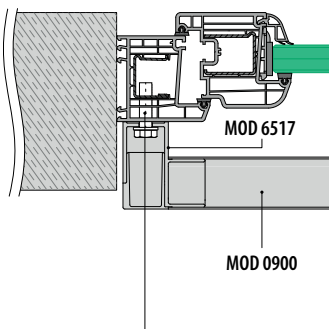

Pour les caractéristiques techniques, veuillez vous référer aux certificats techniques et autres calculs statiques concernant les détails de pose et type de fixations.

Fixations : 457 - 463

Mains-courantes

Embases murales pour tube

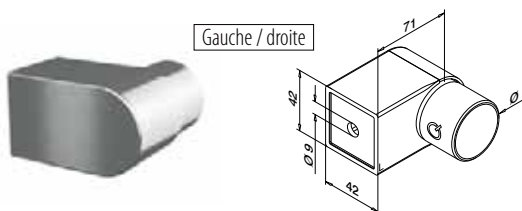

MOD 6517

316	Inox brossé		
OUTDOOR	Pour tube Ø		
146517-242-12	42,4 x 2,0	QS-27 472	2

NEW

Mains-courantes

Tubes

Q-TUBE

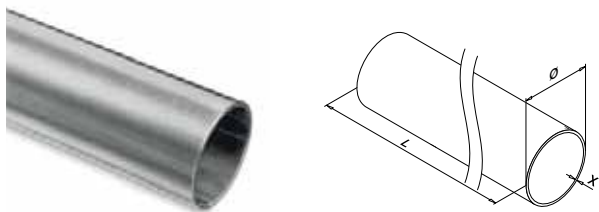

MOD 0900

316	Inox brossé		
OUTDOOR	Ø	X	
140900-242-50-12	42,4	2,0	L = 5 m



Q-INFO

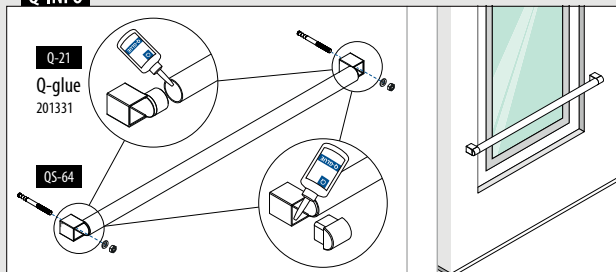

Q-INFO MOD 0900

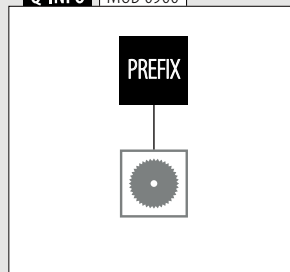



RAMBARDES À BARREAUX EASY ALU

Les rambardes à barreaux Easy Alu sont conçues pour l'installation dans de nombreux projets de construction ou de rénovation. Elles sont disponibles dans une sélection de couleurs RAL thermolaquées vous permettant de trouver à coup sûr celles qui correspondent à la teinte du cahier des charges de votre client. Cette option est disponible sur demande.

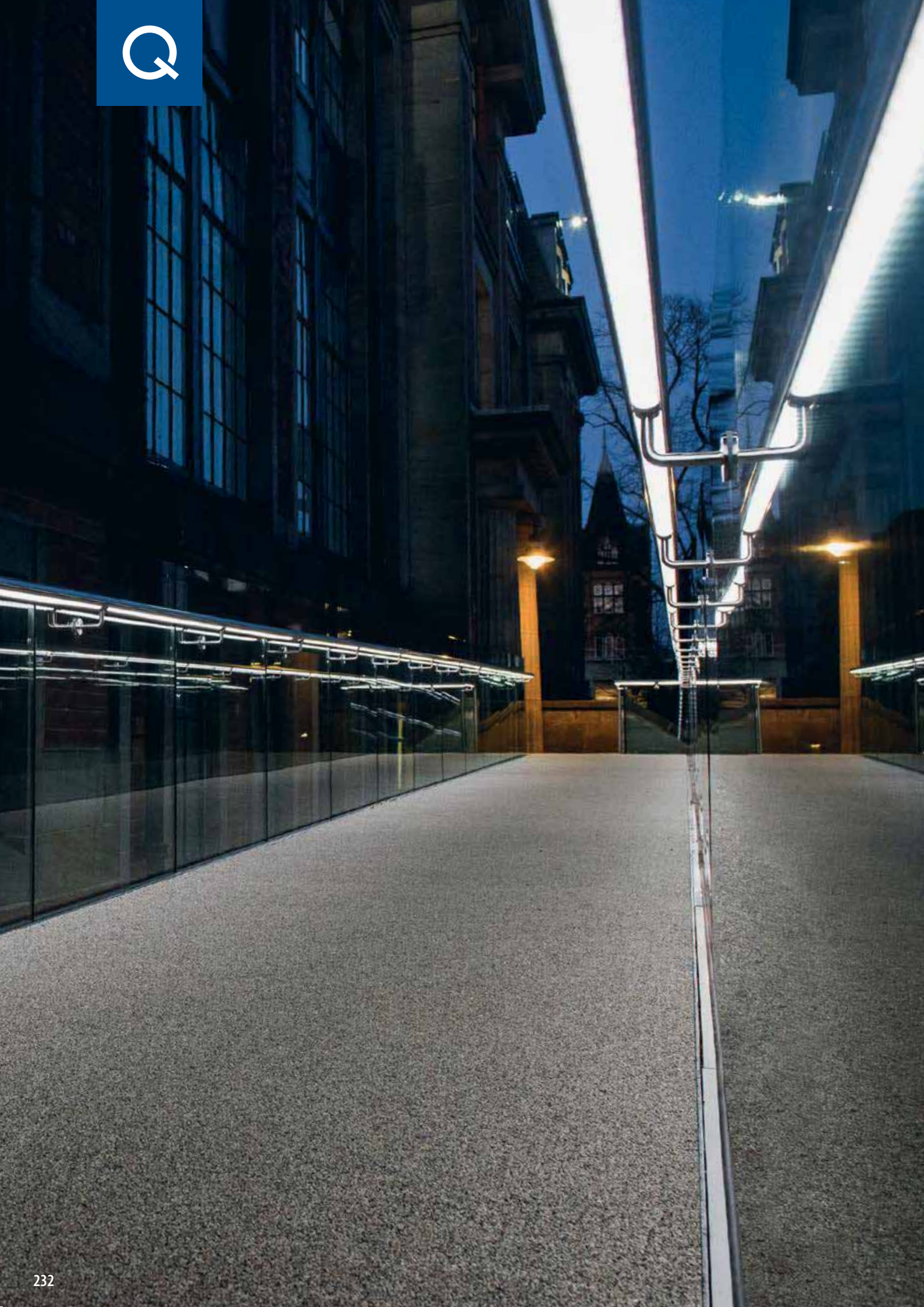

3

SYSTÈMES Q-LIGHTS

Q-lights Spotlight ————— 236 - 237, 260 - 262, 265
Q-lights Linear Light ————— 238 - 265



- Conçu pour :** Utilisation faible à intensive (IK10 contre le vandalisme)
- Utilisation :** Intérieur et extérieur (IP00 - IP66)
- Variantes :** 24 V et 48 V blanc lumineux, neutre et mat ; RGB demande (Linear Light), ainsi que 3000 / 5000 K, 12 V (Spotlight)
- Applications :** Garde-corps en verre, garde-corps à poteaux, garde-corps muraux
- Matériau :** Aluminium, acier inoxydable 304 et 316

Retrouvez toutes les informations sur Spotlight en ligne :



<https://q-ne.ws/Spotlight23>

Retrouvez toutes les informations sur Linear Light en ligne :



<https://q-ne.ws/LinearLight23>

SYSTÈMES Q-LIGHTS



Q-lights Spotlight



Q-lights Linear Light

Transformez vos garde-corps et améliorez la sécurité

Ajouter un éclairage subtil à votre garde-corps sublime non seulement l'ambiance d'un espace, mais améliore aussi la sécurité des utilisateurs. Q-lights Spotlight et Q-lights Linear Light vous offrent une incroyable palette d'effets lumineux. Ces deux systèmes de LED s'intègrent facilement au garde-corps Q-railing que vous avez choisi.

Tests/calculs/certificats internationaux:

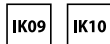

- 1 Les bandes de LED permettent de créer des rails de lumière extrêmement nets et denses.
- 2 Les bandes de LED peuvent mesurer jusqu'à 30 m.
- 3 Améliore la sécurité en illuminant vos garde-corps. Q-lights augmente encore la visibilité de vos garde-corps et de vos passerelles et escaliers à l'intérieur comme à l'extérieur.



DÉCLINAISONS DE Q-LIGHTS

Spotlight

pour main-courante

- Convient aux tubes ronds en acier inoxydable (Ø 42,4 ou 48,3 mm)
- Supports et adaptateurs pour main-courante et embases murales avec goulotte
- Lumière blanche froide (5000 K, 12 V), lumière blanche chaude (3000 K, 12 V)

■ 236 - 237, 260 - 262, 265

Linear Light

pour tubes à fond de gorge

- Bandes de LED allant de 5 à 30 mètres
- Les bandes LED se positionnent devant ou derrière le verre
- Profils en plastique transparent ou dépoli
- Lumière blanche chaude ou froide (24 et 48 V), bandes RGB sur demande

■ 238 - 255

Linear Light

pour main-courante

- Bandes de LED allant de 5 à 30 mètres
- Supports de main-courante avec goulotte
- Adaptateurs pour une installation sur les supports de main-courante
- Profils en plastiques transparents ou dépolis
- Lumière blanche chaude ou froide (24 et 48 V), bandes RGB sur demande

■ 238 - 253, 256 - 265

Pour tube de Ø 42,4 x 2,0 mm

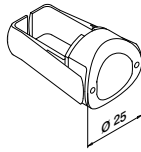
Faisceau lumineux asymétrique
Temp. de couleur 5000 K + 3000 K
50 000 heures d'éclairage

MOD 0051

INDOOR	Couleur (K)	Caractérist. électriques	
190051-242-20-30	Blanc lumineux	0,5W, 12V, 40mA, 22lm	1
190051-242-20-50	Blanc mat	0,5W, 12V, 40mA, 22lm	1

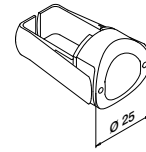

Pour tube de Ø 48,3 x 2,0 mm

Faisceau lumineux asymétrique
Temp. de couleur 5000 K + 3000 K
50 000 heures d'éclairage

MOD 0051

INDOOR	Couleur (K)	Caractérist. électriques	
190051-248-20-30	Blanc lumineux	0,5W, 12V, 40mA, 22lm	1
190051-248-20-50	Blanc mat	0,5W, 12V, 40mA, 22lm	1

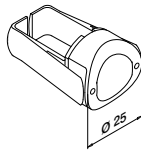

Pour tube de Ø 42,4 x 2,0 mm

Faisceau lumineux asymétrique
Temp. de couleur 5000 K + 3000 K
50 000 heures d'éclairage

MOD 0051

OUTDOOR	Couleur (K)	Caractérist. électriques	
190051-242-66-30	Blanc lumineux	0,55W, 12V, 45mA, 25lm	1
190051-242-66-50	Blanc mat	0,55W, 12V, 45mA, 25lm	1

International Design
Modèle Protection

Pour tube de Ø 48,3 x 2,0 mm

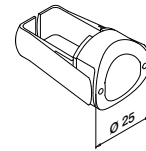
Faisceau lumineux asymétrique
Temp. de couleur 5000 K + 3000 K
50 000 heures d'éclairage

MOD 0051

OUTDOOR	Couleur (K)	Caractérist. électriques	
190051-248-66-30	Blanc lumineux	0,55W, 12V, 45mA, 25lm	1
190051-248-66-50	Blanc mat	0,55W, 12V, 45mA, 25lm	1

International Design
Modèle Protection

Q-INFO

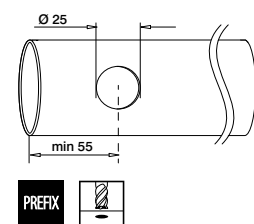

Fraisage recommandé.
A défaut l'utilisation d'un foret étagé est nécessaire. Les trous doivent être ébavurés à l'intérieur et à l'extérieur et la limaille éliminée complètement.



Q-INFO

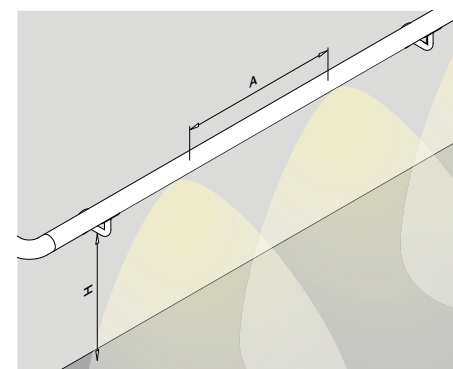

Efficacité lumineuse d'une main courante placée à 900 mm au-dessus du sol/d'un escalier

Hauteur (mm) à partir du nsf (niveau du sol fini): 900mm

Distance du mur (mm)		Distance (A) entre les projecteurs LED (mm)					
		400		600		1000	
		IP20	IP66	IP20	IP66	IP20	IP66
0	52 lx	56 lx	35 lx	37 lx	20 lx	22 lx	
600	32 lx	35 lx	22 lx	24 lx	13 lx	14 lx	

Pour un éclairage optimal, Q-railing recommande un espacement de 600 mm entre les spots.

Les calculs d'espacement entre chaqa led sont donnés à titre indicatif. Chaque configuration étant différente, nous vous recommandons vivement de faire appel à un professionnel.

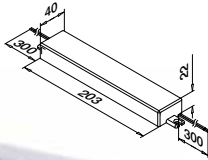

Transformateur 12V
220...240V~, CE, sans prise

**MOD 0013**

IN/OUTDOOR	P	
200013-030-66	30W	1

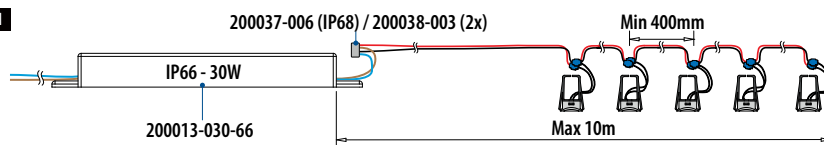
**Q-INFO****Intérieur / extérieur****1**

MOD 0051
de 1 à 25 spot(s)

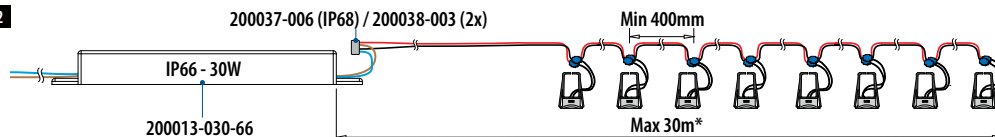
2

MOD 0051
de 1 à 50 spot(s)

* La conformité EMI / EMC doit être respectée

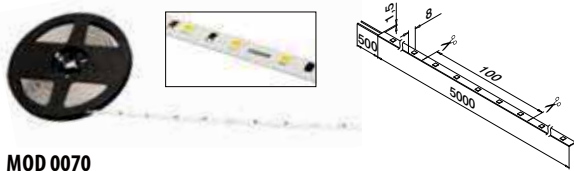
**MOD 0070**

INDOOR	Couleur (K)	LED/m	W	Φ (lm/m)	☐
190070-050-27	Blanc lumineux	70	14	350	L = 5 m
190070-050-65	Blanc mat	70	14	370	L = 5 m

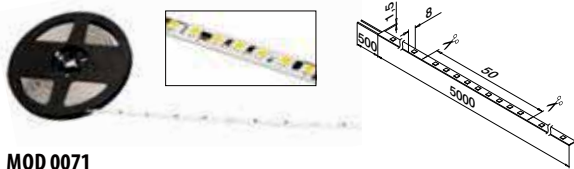
**MOD 0071**

INDOOR	Couleur (K)	LED/m	W	Φ (lm/m)	☐
190071-050-27	Blanc lumineux	140	27,5	660	L = 5 m
190071-050-65	Blanc mat	140	27,5	680	L = 5 m

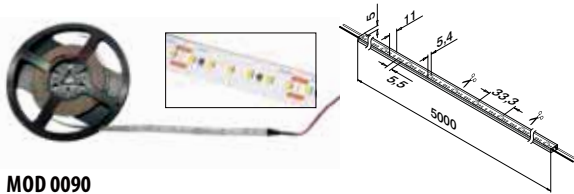
**MOD 0090**

INDOOR	Couleur (K)	LED/m	W	Φ (lm/m)	☐
190090-050-40	Blanche neutre	180	30	650	L = 5 m

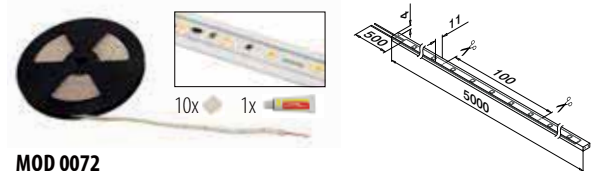
**MOD 0072**

OUTDOOR	Couleur (K)	LED/m	W	Φ (lm/m)	☐
190072-050-30	Blanc lumineux	70	14	350	L = 5 m
190072-050-65	Blanc mat	70	14	360	L = 5 m

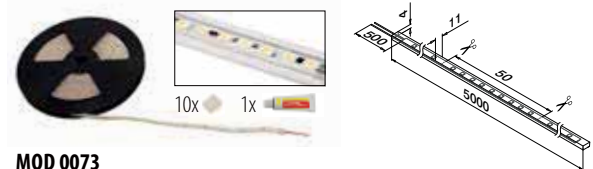
**MOD 0073**

OUTDOOR	Couleur (K)	LED/m	W	Φ (lm/m)	☐
190073-050-30	Blanc lumineux	140	27,5	640	L = 5 m
190073-050-65	Blanc mat	140	27,5	650	L = 5 m

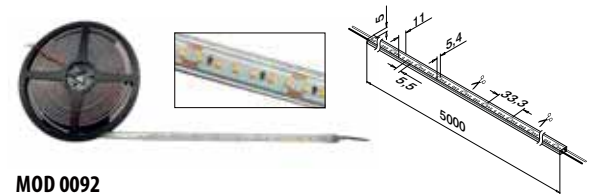
**MOD 0092**

OUTDOOR	Couleur (K)	LED/m	W	Φ (lm/m)	☐
190092-050-40	Blanche neutre	180	30	650	L = 5 m

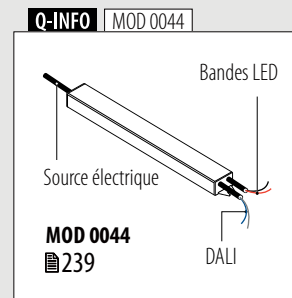
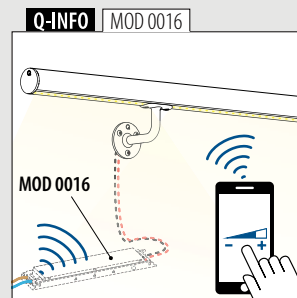

Q-INFO
<p>MOD 0070 / 0072: 70 LED/m</p>
<p>MOD 0071 / 0073: 140 LED/m</p>
<p>MOD 0090 / 0092: 180 LED/m</p>

**Q-INFO**

INFORMATIONS BANDES LED

- Toutes les bandes sont pré-câblées une fois. Pour davantage de connections, utilisez un câble de liaison (■ 240-242).
- Chaque bande peut être coupée à la longueur prédéfinie entre les points de cuivre sur la bande à l'aide de ciseaux.
- Bandes LED peuvent être coupées et reliées au moyen d'un raccordement (■ 240-242).
- Tous les modèles d'adaptent aux pièces de raccord de tubes à fond de gorge Linear Light (■ 254-255) et à la main-courante Linear Light (■ 256-265).

Transformateurs

Transformateur 24V

pour Q-lights Linear Light IP20
220...240V~

MOD 0015

INDOOR	P	
200015-100-20	100W	1

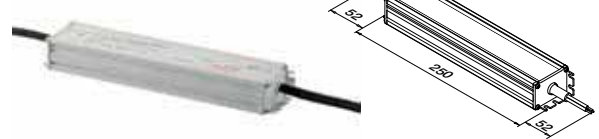

Transformateur 24V

pour Q-lights Linear Light IP67
220...240V~

MOD 0015

OUTDOOR	P	
200015-100-67	100W	1

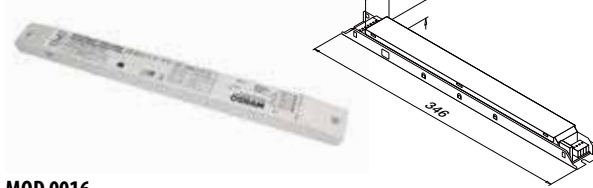

Transformateur avec bluetooth unité de 24 V

pour Q-lights Linear Light IP20
220...240V~

MOD 0016

INDOOR	P	
200016-080	80W	1

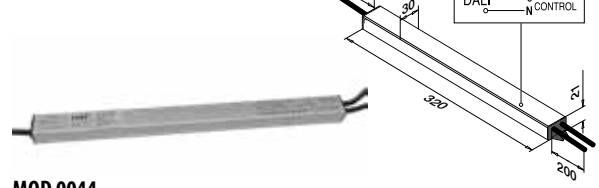

Transformateur 24V avec DALI

pour Q-lights Linear Light IP67
220...240V~ CE

MOD 0044

OUTDOOR	P	
200044-100-67	100W	1



Q-INFO | MOD 007x / 009x

Aperçu des spécifications techniques des bandes LED Q-lights Linear Light

Bandes LED	IP	V	W	W/m	K	Colour	lm	lm/m	LED/m	L (mm)	L _{mm} (mm)	Gradable	Life	CRI	RA
190070-050-27	00	24	14	2,8	2700	blanc lumineux	1750	350	120	70	5000	✓	50.000 h	>80	20
190070-050-65	00	24	14	2,8	6500	blanc mat	1850	370	120	70	5000	✓	50.000 h	>80	20
190072-050-30	66	24	14	2,8	3000	blanc lumineux	1750	350	120	70	5000	✓	50.000 h	>80	20
190072-050-65	66	24	14	2,8	6500	blanc mat	1800	360	120	70	5000	✓	50.000 h	>80	20
190071-050-27	00	24	27,5	5,5	2700	blanc lumineux	3100	620	120	140	5000	✓	50.000 h	>80	50
190071-050-65	00	24	27,5	5,5	6500	blanc mat	3400	680	120	140	5000	✓	50.000 h	>80	50
190073-050-30	66	24	27,5	5,5	3000	blanc lumineux	3200	640	120	140	5000	✓	50.000 h	>80	50
190073-050-65	66	24	27,5	5,5	6500	blanc mat	3250	650	120	140	5000	✓	50.000 h	>80	50
190090-050-40	20	24	30	6	4000	blanche neutre	3250	650	120	180	5000	✓	50.000 h	94	50
190092-050-40	54	24	30	6	4000	blanche neutre	3250	650	120	180	5000	✓	50.000 h	94	50

IP...	IP Indice de protection	W/m	Puissance nominale par mètre	lm	Flux lumineux	LED/m	Nombre de LED par mètre
V	Tension nominale	K	Temp. de couleur	lm/m	Flux lumineux par mètre	Gradable	Gradable
W	Puissance nominale	Colour	Teinte de couleur	Angle de rayonnement	Angle de rayonnement	Durée de vie	Durée de vie

Q-INFO | MOD 007x

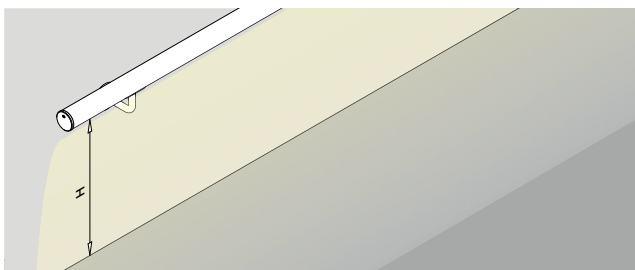

Valeurs indicatives en lux

Eclairage solaire direct	= 100.000 lx	Eclairage d'un hall	= 100 lx
Temps couvert,	= 1.000 lx	Eclairage d'une rue	= 10 lx
éclairage type d'un studio de TV		Eclairage d'une bougie à 1 m. de distance env.	= 1 lx

Les calculs d'espacement entre chaque led sont donnés à titre indicatif.
Chaque configuration étant différente, nous vous recommandons vivement de faire appel à un professionnel.

Efficacité lumineuse d'une main courante placée au dessus d'un sol / d'un escalier

	Hauteur (mm) à partir du nsf (niveau du sol fini)			
	900	1000	1100	1200
190070-050-27	125 lx	106 lx	90 lx	78 lx
190070-050-65	144 lx	113 lx	94 lx	82 lx
190072-050-30	106 lx	90 lx	75 lx	66 lx
190072-050-65	111 lx	94 lx	78 lx	69 lx
190071-050-27	203 lx	172 lx	144 lx	121 lx
190071-050-65	223 lx	198 lx	151 lx	131 lx
190073-050-30	203 lx	172 lx	120 lx	92 lx
190073-050-65	217 lx	184 lx	130 lx	100 lx
190090-050-40	163 lx	139 lx	120 lx	104 lx
190092-050-40	163 lx	139 lx	120 lx	104 lx

Raccord universel bande à bande



MOD 0046

INDOOR	Pour MOD	V	
200046-008	0070, 0071	24 / 48	1
200046-010	0080, 0090	24 / 48	1

NEW IP20

Raccord d'angle universel

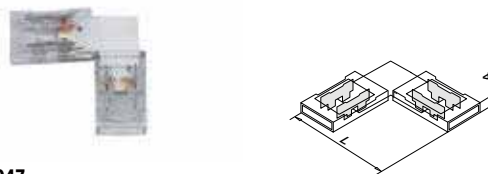

MOD 0047

INDOOR	Pour MOD	V	L	
200047-008	0070, 0071	24 / 48	25	1
200047-010	0080, 0090	24 / 48	30	1

NEW IP20

Raccord flexible universel

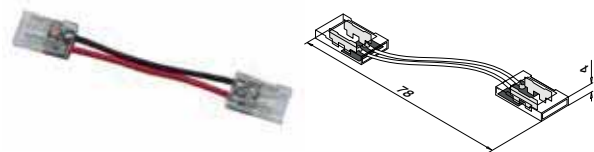

MOD 0048

INDOOR	Pour MOD	V	
200048-008	0070, 0071	24 / 48	1
200048-010	0080, 0090	24 / 48	1

NEW IP20

Câble de raccord universel

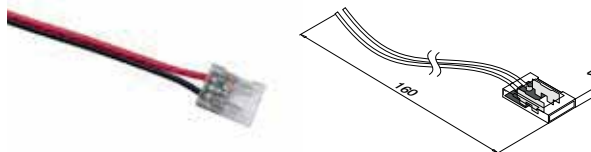

MOD 0049

INDOOR	Pour MOD	V	
200049-008	0070, 0071	24 / 48	1
200049-010	0080, 0090	24 / 48	1

NEW IP20

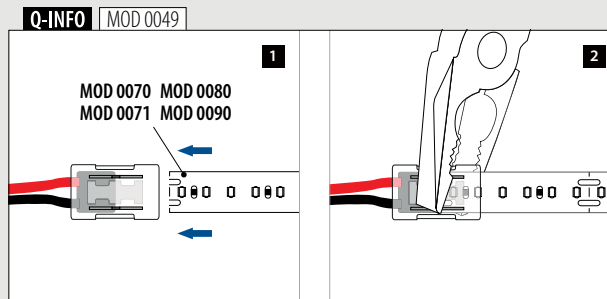
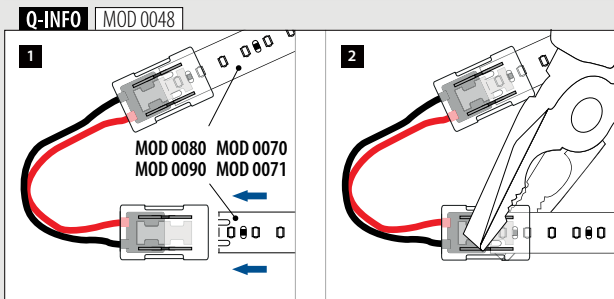
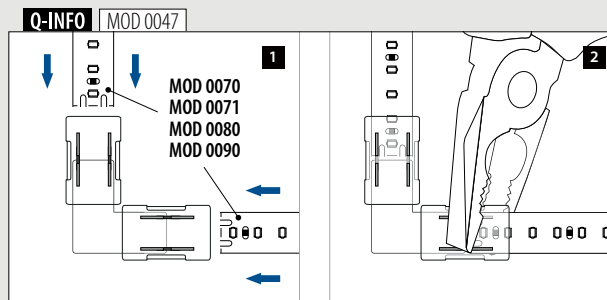
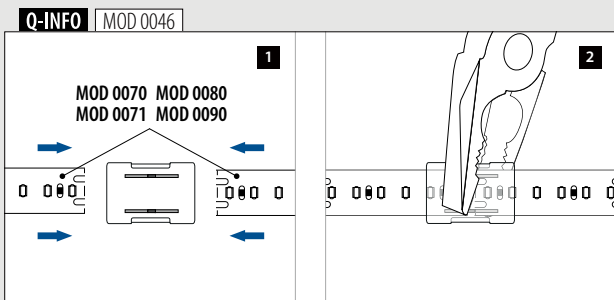

Raccord universel bande à bande

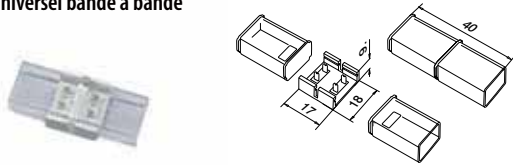

MOD 0053

OUTDOOR	Pour MOD	V	
200053	0072, 0073, 0082, 0092	24 / 48	1



Raccord flexible universel

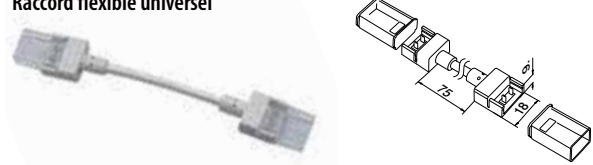

MOD 0054

OUTDOOR	Pour MOD	V	
200054	0072, 0073, 0082, 0092	24 / 48	1



Câble de raccord universel

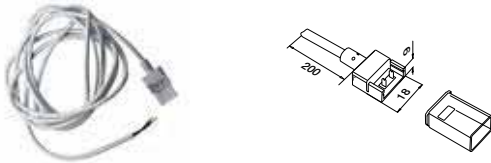

MOD 0055

OUTDOOR	Pour MOD	V	
200055	0072, 0073, 0082, 0092	24 / 48	1



Silicone et embouts

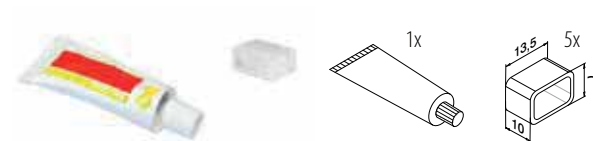

MOD 0039

OUTDOOR	
200039	1

Q-INFO MOD 0053 / 0054 / 0055

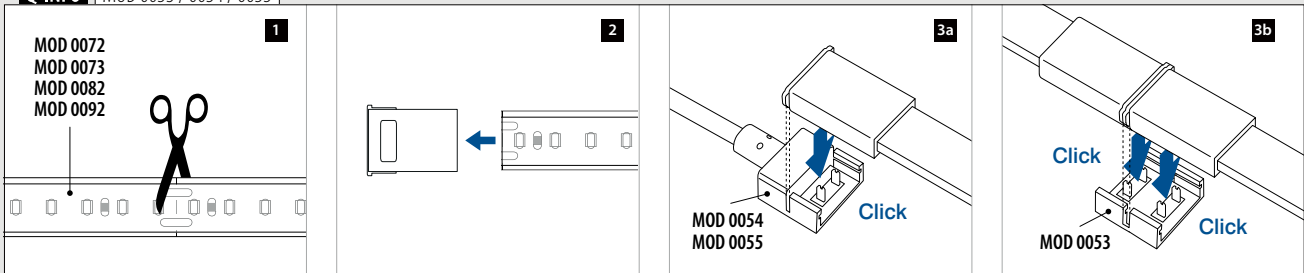

Q-INFO MOD 0039

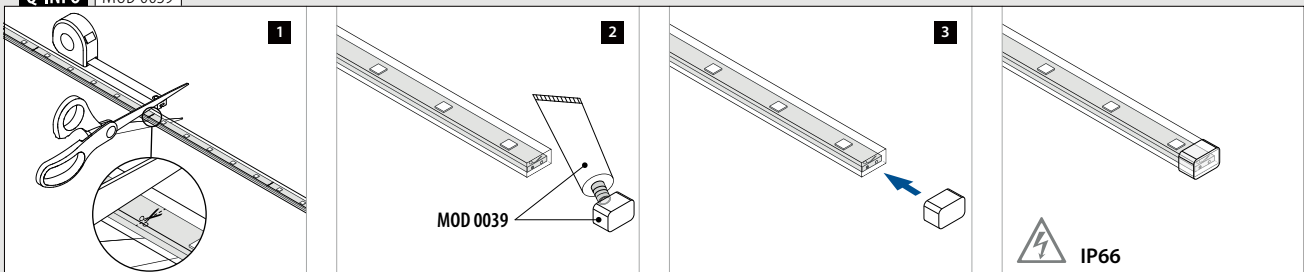

Câble de raccordement pour bande LED
pour MOD 0070 / 0071

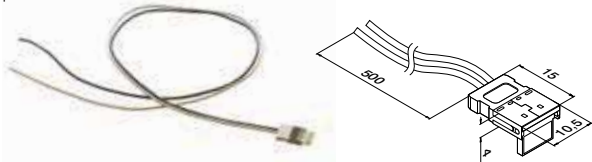

MOD 0020				
INDOOR	V	L		
200020-20	24	500	1	

IP20

Câble de raccordement pour bande LED
pour MOD 0072 / 0073

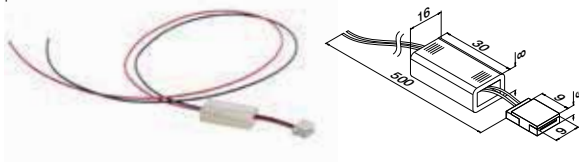

MOD 0020				
OUTDOOR	V	L		
200020-54	24V	500	1	

IP54

Raccord de bande LED

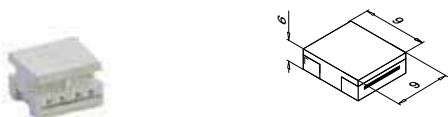

MOD 0018				
INDOOR				
200018			1	

IP20

Câble de raccordement pour bande LED



MOD 0019				
INDOOR				
200019			1	

SELL OUT

IP20

Gaine pour raccord de bande LED
pour bande LED MOD 0072 / 0073



MOD 0023				
OUTDOOR				
200023			1	

IP54



SELL OUT Seulement jusqu'à épuisement des stocks.

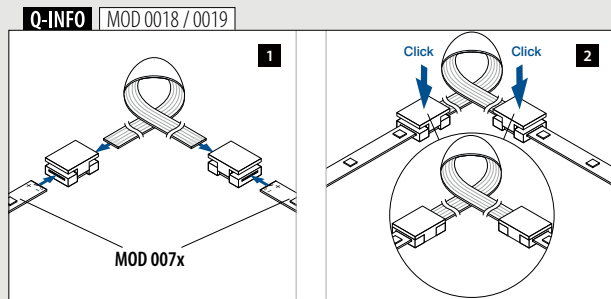
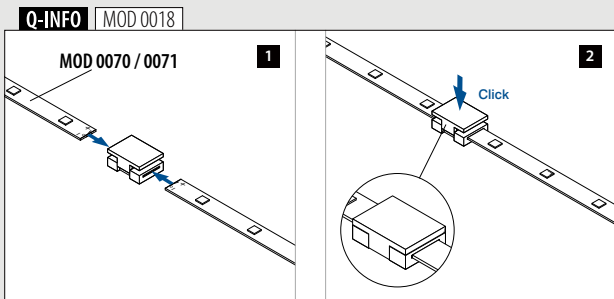
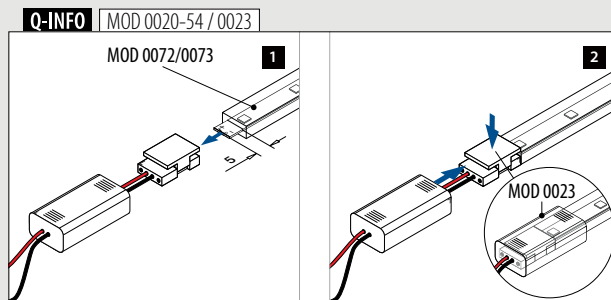
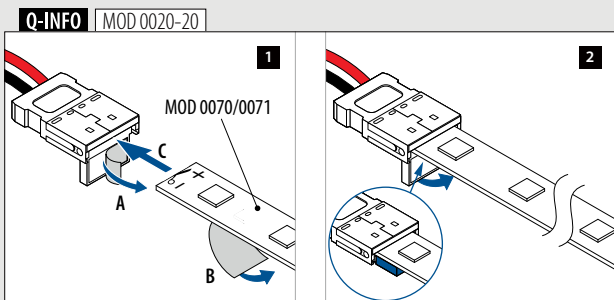

Q-INFO | MOD 0070/0071

Intérieur

1

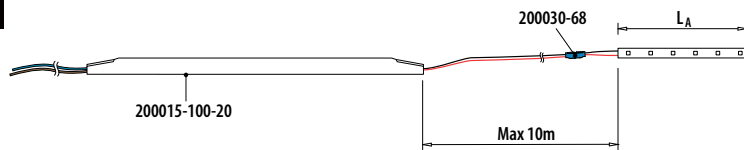

MOD 0070/0071
 $L_A \leq 5,00$ m

2

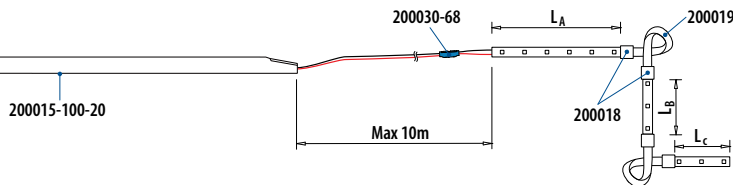

MOD 0070/0071
 $L_A + L_B + L_C \leq 5,00$ m

3A

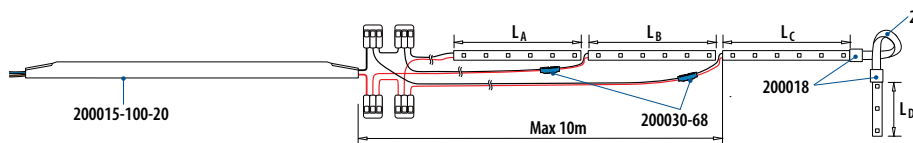

MOD 0070/0071
 $L_A \leq 5,00$ m
 $L_B \leq 5,00$ m
 $L_C + L_D \leq 5,00$ m
 MOD 0070: $L_A + L_B + L_C + L_D \leq 20,00$ m
 MOD 0071: $L_A + L_B + L_C + L_D \leq 15,00$ m

3B

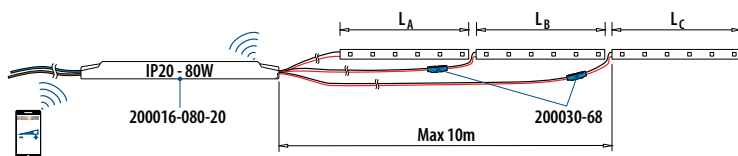

MOD 0070/0071
 $L_A + L_B \leq 5,00$ m
 $L_C \leq 5,00$ m
 $L_D \leq 5,00$ m
 MOD 0070: $L_A + L_B + L_C + L_D \leq 15,00$ m
 MOD 0071: $L_A + L_B + L_C + L_D \leq 13,50$ m

Q-INFO | MOD 0072/0073

Extérieur

4

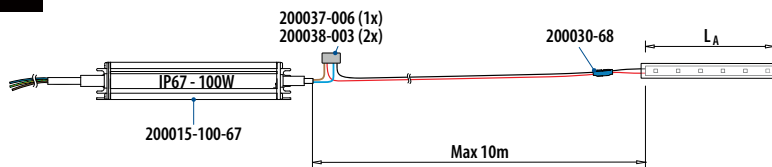

MOD 0072/0073
 $L_A + L_B + L_C \leq 5,00$ m

5

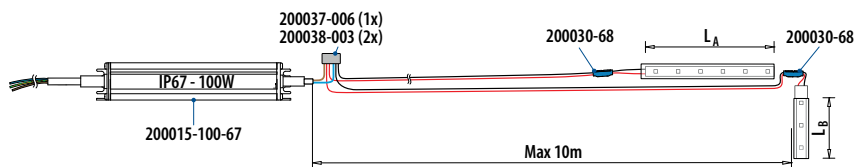

MOD 0072/0073
 $L_A \leq 5,00$ m
 $L_B \leq 5,00$ m
 $L_C + L_D \leq 5,00$ m
 $L_A + L_B + L_C + L_D \leq 15,00$ m

6

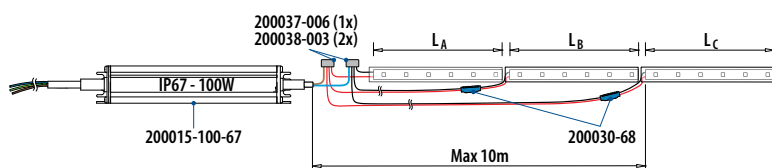

MOD 0072/0073
 $L_A \leq 5,00$ m
 $L_B \leq 5,00$ m
 $L_C + L_D \leq 5,00$ m
 $L_A + L_B + L_C + L_D \leq 15,00$ m

Q-INFO | MOD 0090

Intérieur

1

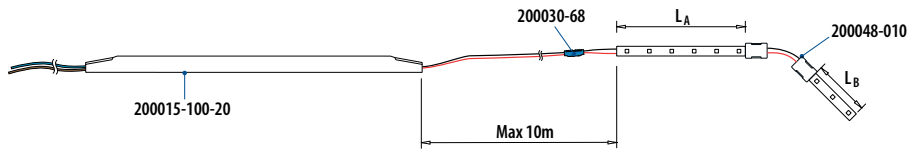

MOD 0090
 $L_A \leq 5,00 \text{ m}$
 $L_B \leq 5,00 \text{ m}$
 $L_A + L_B \leq 10,00 \text{ m}$

2

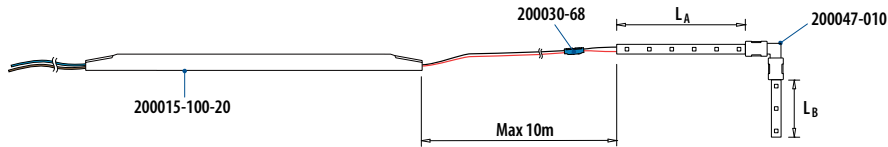

MOD 0090
 $L_A \leq 5,00 \text{ m}$
 $L_B \leq 5,00 \text{ m}$
 $L_A + L_B \leq 10,00 \text{ m}$

3

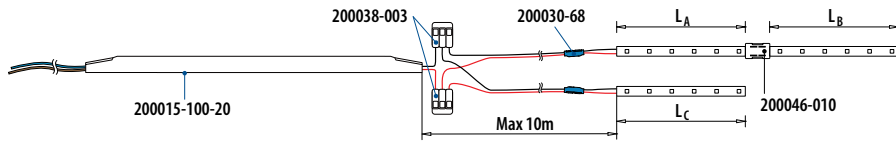

MOD 0090
 $L_A \leq 5,00 \text{ m}$
 $L_B \leq 5,00 \text{ m}$
 $L_A + L_B \leq 10,00 \text{ m}$
 $L_A + L_B + L_C \leq 15,00 \text{ m}$

Q-INFO | MOD 0092

Extérieur

4

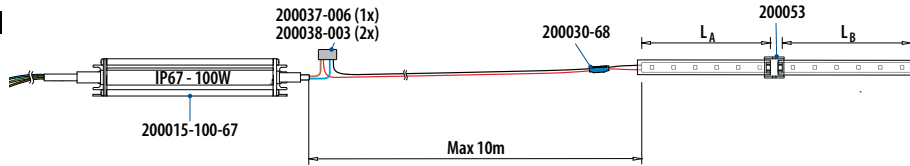

MOD 0092
 $L_A + L_B \leq 10,00 \text{ m}$

5

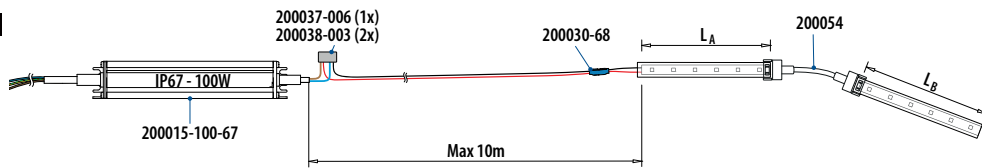

MOD 0092
 $L_A + L_B \leq 10,00 \text{ m}$

6

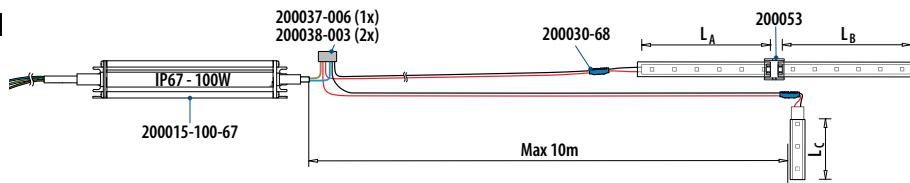

MOD 0092
 $L_A \leq 5,00 \text{ m}$
 $L_B \leq 5,00 \text{ m}$
 $L_A + L_B \leq 10,00 \text{ m}$
 $L_A + L_B + L_C \leq 15,00 \text{ m}$

Bandes LED

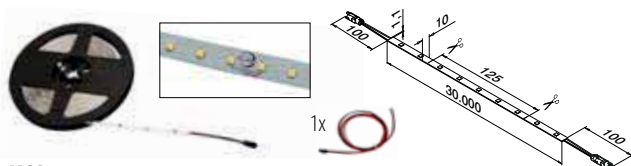

MOD 0080

INDOOR	Couleur (K)	LED/m	W	Φ (lm/m)	☐
190080-300-30	Blanc lumineux	84	117	424	L = 30 m
190080-300-65	Blanc mat	84	117	437	L = 30 m

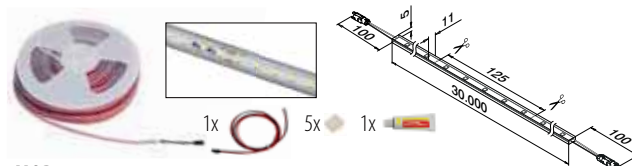

MOD 0082

OUTDOOR	Couleur (K)	LED/m	W	Φ (lm/m)	☐
190082-300-30	Blanc lumineux	84	117	390	L = 30 m
190082-300-65	Blanc mat	84	117	402	L = 30 m



Q-INFO

INFORMATIONS BANDES LED

- Toutes les bandes sont pré-câblées une fois. Pour davantage de connections, utilisez un câble de liaison (■ 247-250).
- Chaque bande peut être coupée à la longueur prédéfinie entre les points de cuivre sur la bande à l'aide de ciseaux.
- Bandes LED peuvent être coupées et reliées au moyen d'un raccordement (■ 247-250).
- Tous les modèles d'adaptent aux pièces de raccord de tubes à fond de gorge Linear Light (■ 254-255) et à la main-courante Linear Light (■ 256-265).

Transformateur 48V
pour Q-lights Linear Light IP67
220...240V~, CE

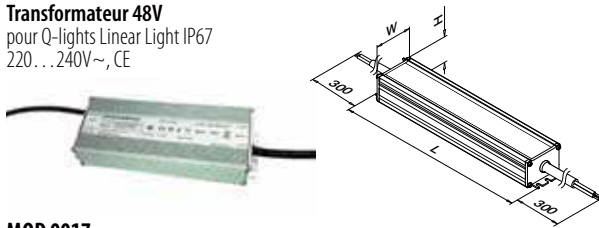

MOD 0017

OUTDOOR	P	L	W	H	
200017-060-67	60 W	116	67,5	36,5	1
200017-150-67	150 W	166	67,5	40	1
200017-350-67	350 W	227	80	42	1



Transformateur 48V
pour Q-lights Linear Light IP67
220...240V~, CE

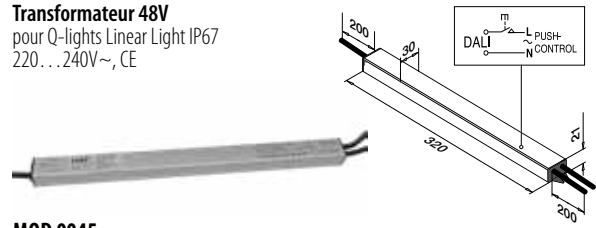

MOD 0045

OUTDOOR	W	
200045-240-67	240	1



Transformateur 48V
pour Q-lights Linear Light IP67
220...240V~, CE

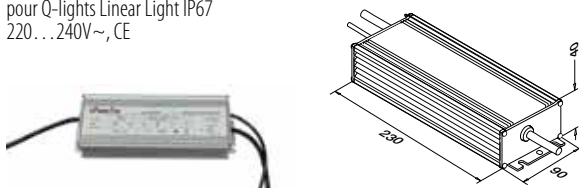

MOD 0045

OUTDOOR	W	
200045-400-67	400	1



Q-INFO | MOD 0045

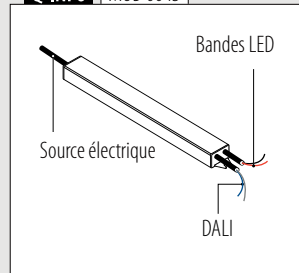

Q-INFO | MOD 008x

Aperçu des spécifications techniques des bandes LED Q-lights Linear Light

Bandes LED	IP	V	W	W/m	K	Colour	lm	lm/m		LED/m	L (mm)	L _{min} (mm)			CRI	
190080-300-30	20	48	117	3,9	3000	blanc lumineux	12.720	424	120	84	30.000	125	✓	50.000 h	>80	30
190080-300-65	20	48	117	3,9	6500	blanc mat	13.110	437	120	84	30.000	125	✓	50.000 h	>80	30
190082-300-30	66	48	117	3,9	3000	blanc lumineux	11.700	390	120	84	30.000	125	✓	50.000 h	>80	30
190082-300-65	66	48	117	3,9	6500	blanc mat	12.060	402	120	84	30.000	125	✓	50.000 h	>80	30

IP... IP Indice de protection	W/m Puissance nominale par mètre	lm Flux lumineux	LED/m Nombre de LED par mètre
V Tension nominale	K Temp. de couleur	lm/m Flux lumineux par mètre	Gradable
W Puissance nominale	Colour Teinte de couleur	Angle de rayonnement	Durée de vie

Q-INFO | MOD 008x

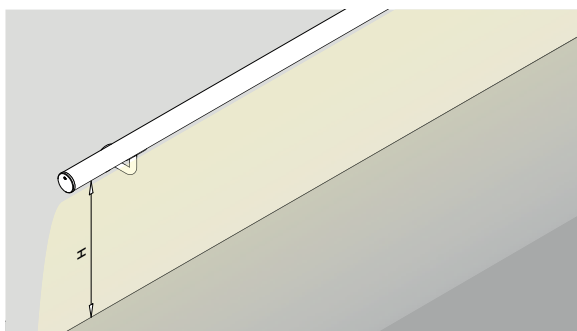

Efficacité lumineuse d'une main courante placée au dessus d'un sol / d'un escalier

	Hauteur (mm) à partir du nsf (niveau du sol fini)			
	900	1000	1100	1200
190080-300-30	165 lx	156 lx	146 lx	135 lx
190080-300-65	173 lx	163 lx	152 lx	141 lx
190082-300-30	154 lx	145 lx	136 lx	124 lx
190082-300-65	160 lx	150 lx	140 lx	128 lx

Valeurs indicatives en lux

Eclairage solaire direct = 100.000 lx	Eclairage d'un hall = 100 lx
Temps couvert, = 1.000 lx	Eclairage d'une rue = 10 lx
éclairage type d'un studio de TV	Eclairage d'une bougie à 1 m. de distance env. = 1 lx

Les calculs d'espacement entre chaque led sont donnés à titre indicatif.
Chaque configuration étant différente, nous vous recommandons vivement de faire appel à un professionnel.

Câble de raccordement pour bande LED, femelle

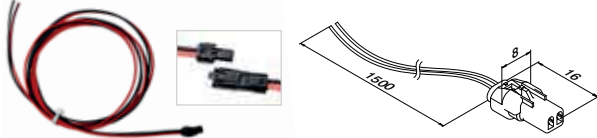

MOD 0032				
OUTDOOR	V	L		
200032-015-68	48	1500	1	

IP68

Silicone et embouts

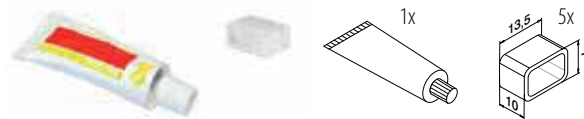

MOD 0039				
OUTDOOR				
200039			1	

Raccord de bande LED

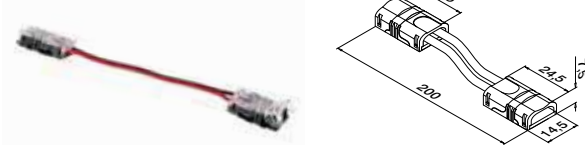

MOD 0028				
INDOOR				
200028			1	

IP20

Raccord de bande LED

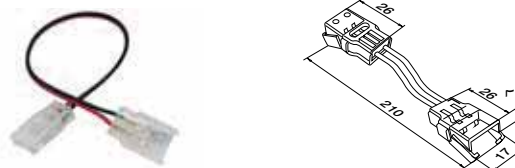

MOD 0031				
OUTDOOR				
200031			1	

IP66

SYSTEMES Q-LIGHTS

Q-LIGHTS - ACCESSOIRES POUR LE RACCORDEMENT

Q-INFO MOD 0032

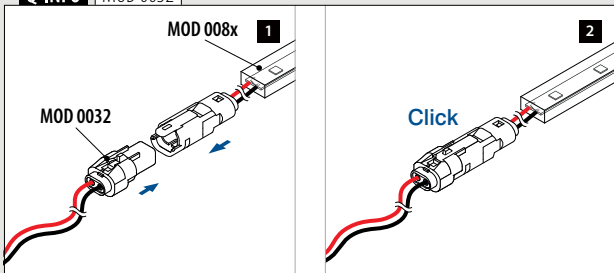

Q-INFO

INFORMATIONS BANDES LED

- Chaque bande est livré avec MOD 0032 ET MOD 0039.
- Pour des connecteurs en plus utilisez MOD 0035, (248) et du câble.

Q-INFO MOD 0028

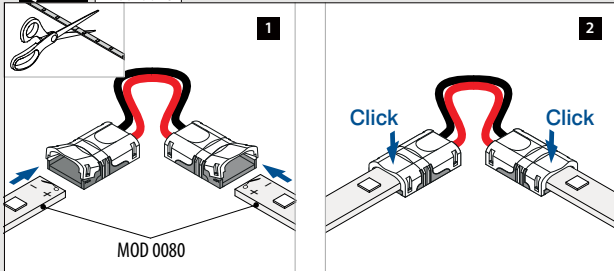

Q-INFO MOD 0031

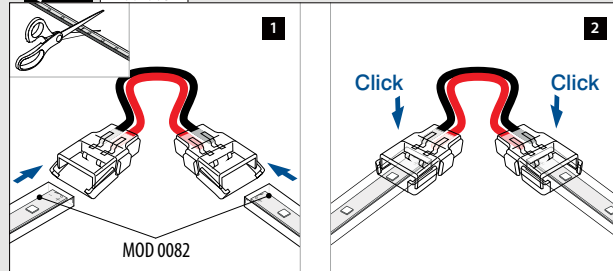

Q-INFO MOD 0039

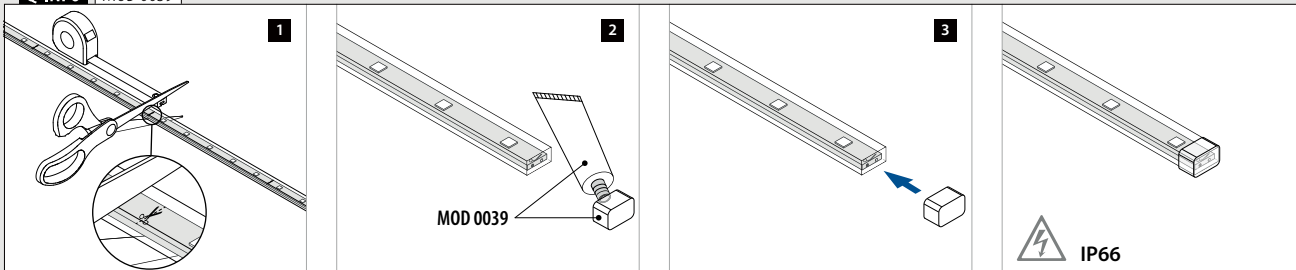

Connection male-male

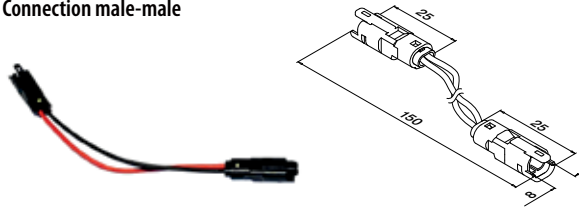

MOD 0035

OUTDOOR



200035

1

IP68

Q-INFO | MOD 0035 / 0032 / 008x

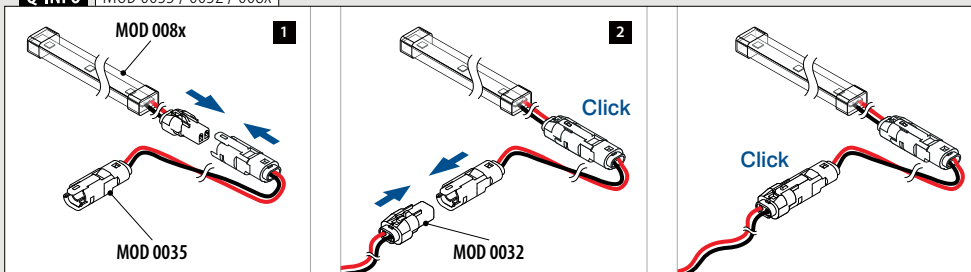

Raccord universel bande à bande



MOD 0046

INDOOR	Pour MOD	V	
200046-008	0070, 0071	24 / 48	1
200046-010	0080, 0090	24 / 48	1

NEW IP20

Raccord flexible universel

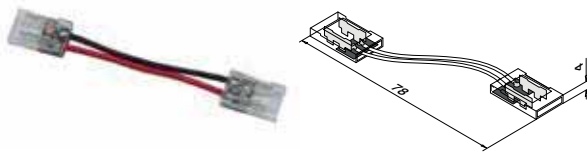

MOD 0048

INDOOR	Pour MOD	V	
200048-008	0070, 0071	24 / 48	1
200048-010	0080, 0090	24 / 48	1

NEW IP20

Raccord d'angle universel

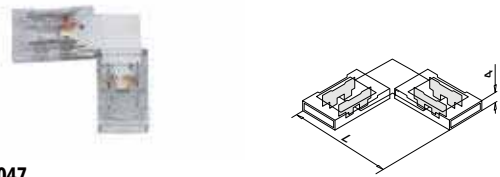

MOD 0047

INDOOR	Pour MOD	V	L	
200047-008	0070, 0071	24 / 48	25	1
200047-010	0080, 0090	24 / 48	30	1

NEW IP20

Câble de raccord universel

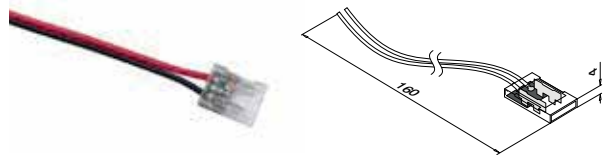

MOD 0049

INDOOR	Pour MOD	V	
200049-008	0070, 0071	24 / 48	1
200049-010	0080, 0090	24 / 48	1

NEW IP20

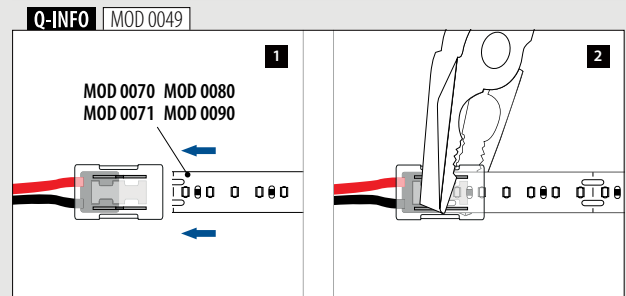
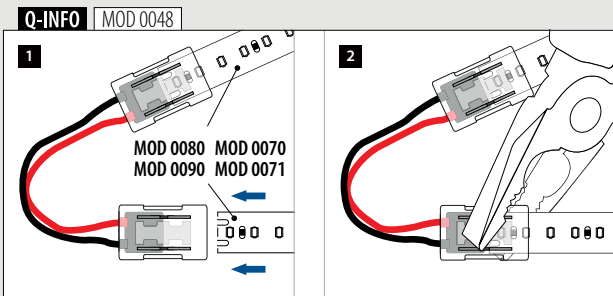
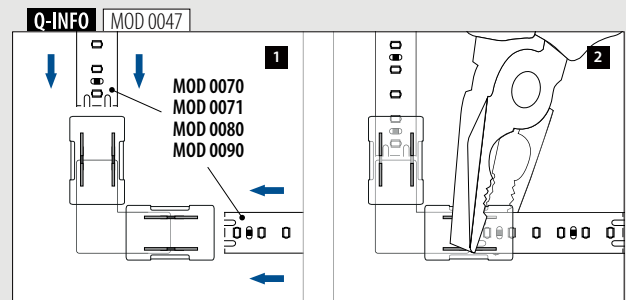
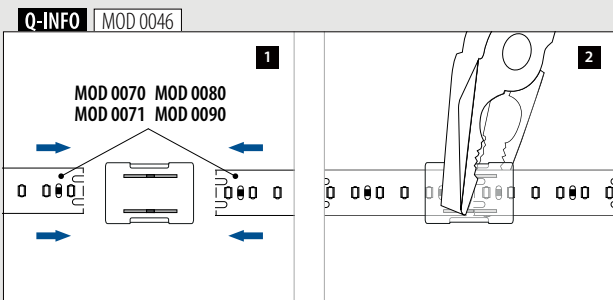

Raccord universel bande à bande

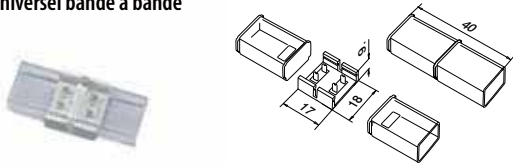

MOD 0053

OUTDOOR	Pour MOD	V	
200053	0072, 0073, 0082, 0092	24 / 48	1

NEW IP68

Raccord flexible universel

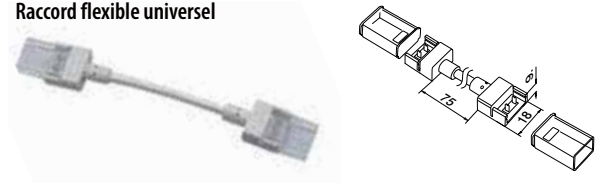

MOD 0054

OUTDOOR	Pour MOD	V	
200054	0072, 0073, 0082, 0092	24 / 48	1

NEW IP68

Câble de raccord universel

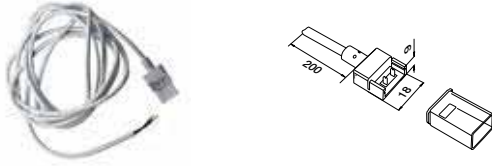

MOD 0055

OUTDOOR	Pour MOD	V	
200055	0072, 0073, 0082, 0092	24 / 48	1

NEW IP68

SYSTÈMES Q-LIGHTS

Q-LIGHTS - ACCESSOIRES POUR LE RACCORDEMENT

MOD 0053 / 0054 / 0055

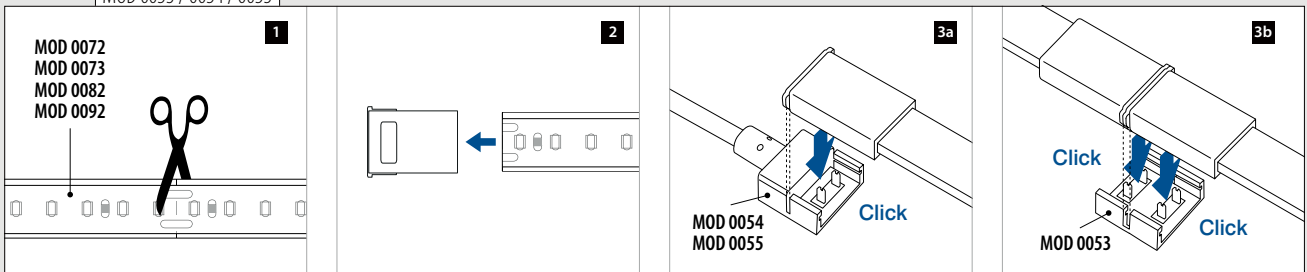

Q-INFO | MOD 008x

Intérieur / extérieur

1

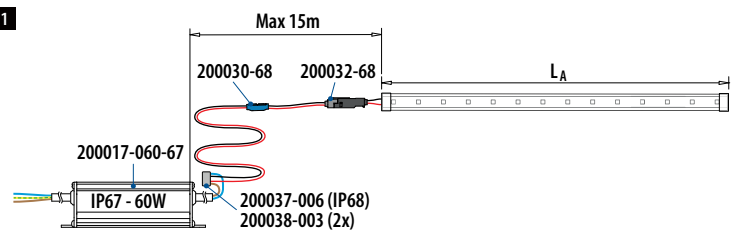

MOD 0080/0082
 $L_A \leq 15,00 \text{ m}$

2

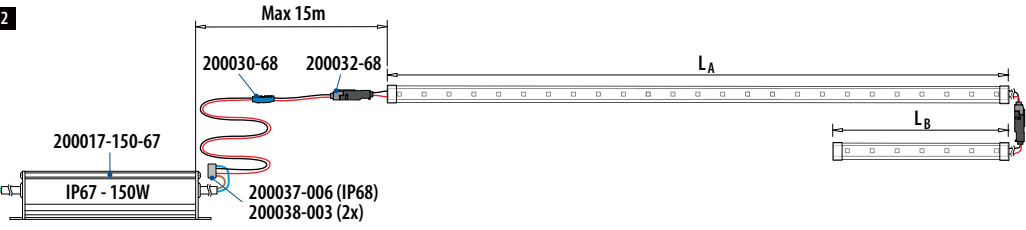

MOD 0080/0082
 $L_A + L_B \leq 38,00 \text{ m}$

3

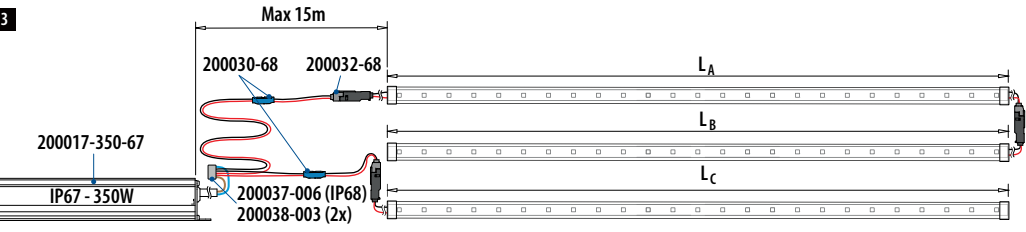

MOD 0080/0082
 $L_A + L_B \leq 60,00 \text{ m}$
 $L_C \leq 30,00 \text{ m}$
 $L_A + L_B + L_C \leq 90,00 \text{ m}$

4

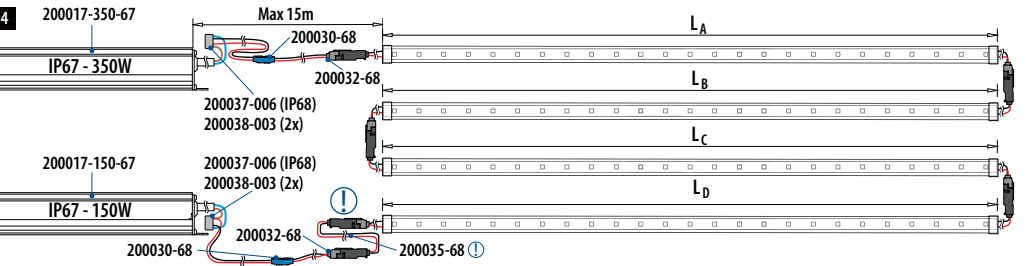

MOD 0080/0082
 $L_A + L_B + L_C + L_D \leq 120,00 \text{ m}$

Q-INFO | MOD 008x

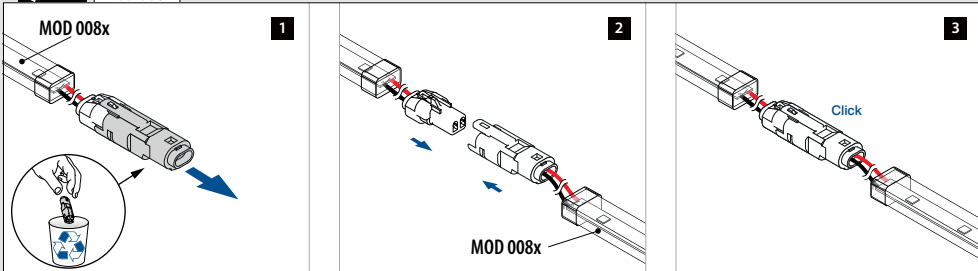

Q-INFO | MOD 0035 / 0032 / 008x

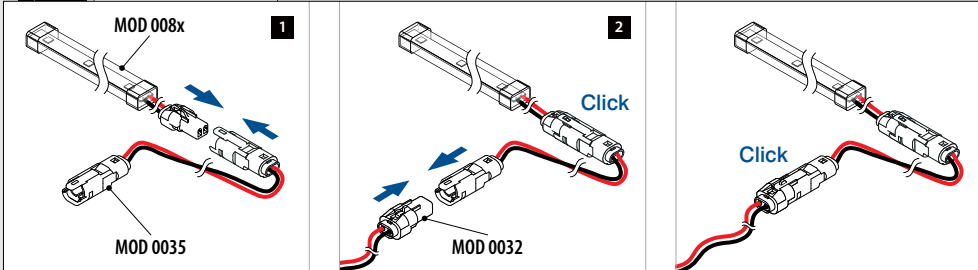

Contrôleur
pour 12V et 24V

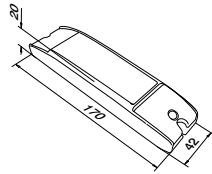

MOD 0040		
INDOOR		
200040	1	

NEW

Contrôleur
pour 24V et 48V

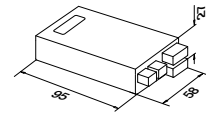

MOD 0041		
INDOOR		
200041	1	

NEW

Alimentations



Câble noir

Sans halogène,
145°C, pour 12V, 24V et 48V,
adapté à un usage extérieur

MOD 0012		
OUTDOOR	Ø	
200012-001-01	1 mm ²	L = 100 m
200012-003-01	2,5 mm ²	L = 100 m

NEW



Câble rouge

Sans halogène,
145°C, pour 12V, 24V et 48V,
adapté à un usage extérieur

MOD 0012		
OUTDOOR	Ø	
200012-001-02	1 mm ²	L = 100 m
200012-003-02	2,5 mm ²	L = 100 m

NEW

SYSTÈMES Q-LIGHTS

Q-LIGHTS - ACCESSOIRES POUR LE RACCORDEMENT

Q-INFO | MOD 0040

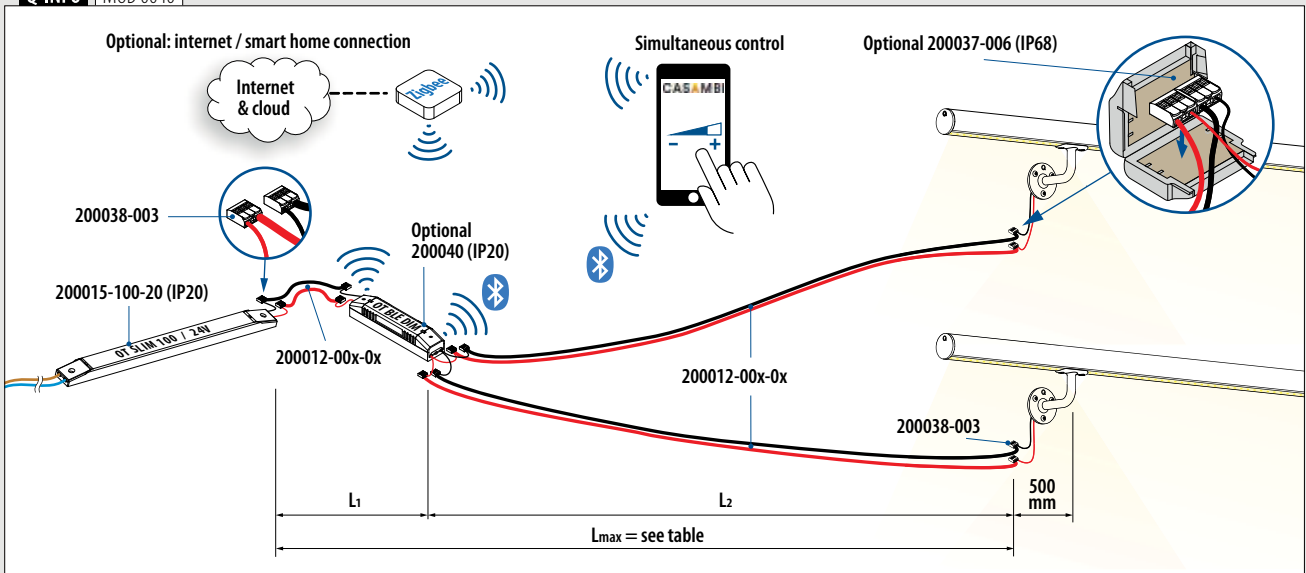

Q-INFO | MOD 0041

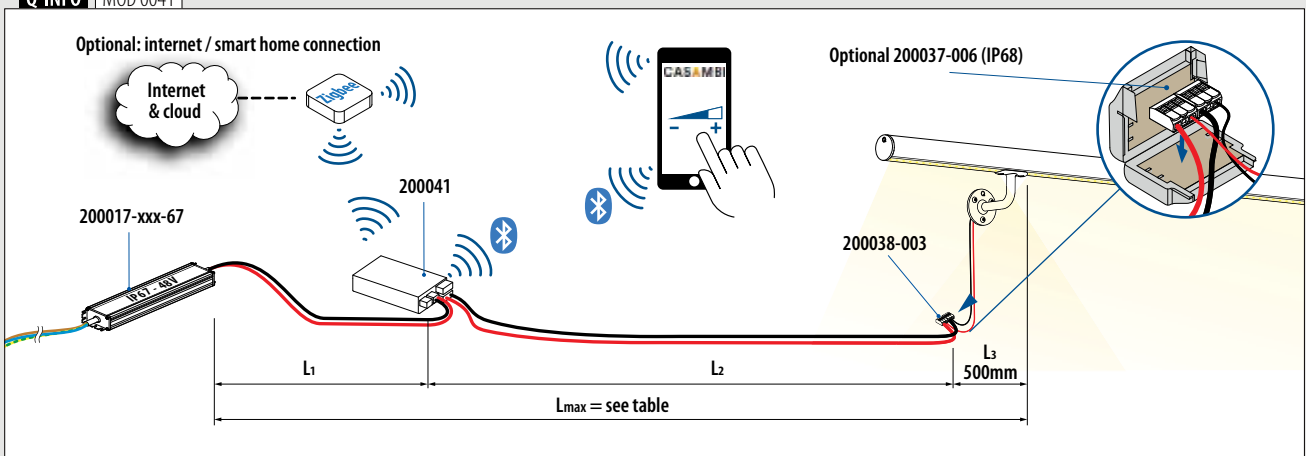

Alimentations

Connecteur pour câble

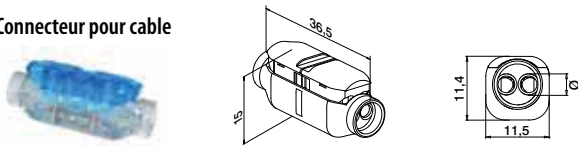

MOD 0030

OUTDOOR	Ø	AWG	□
200030-68	0,5 - 1 mm ²	17 - 20	15

IP68

Gelbox



MOD 0037

OUTDOOR	□
200037-006	1

IP68

Borne de raccordement



MOD 0038

INDOOR	Ø	□
200038-003	0,14 - 4 mm ²	12

IP20

Q-INFO MOD 0030

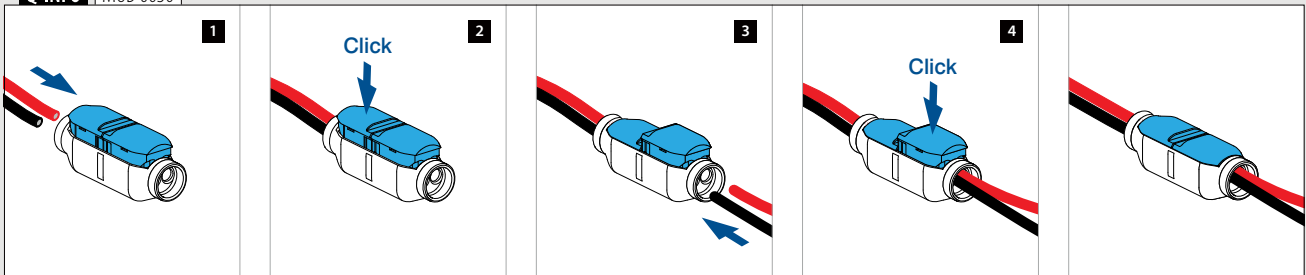

Q-INFO MOD 0038

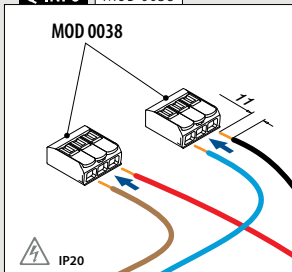

Q-INFO MOD 0038

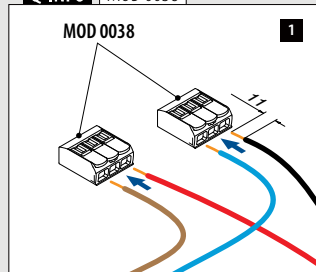

Q-INFO MOD 0037

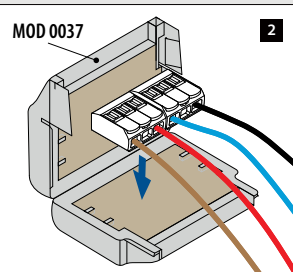

Q-INFO MOD 0037

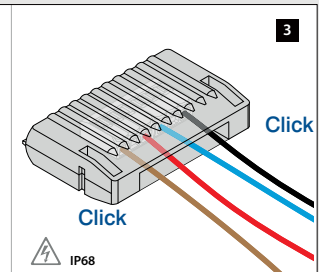

Q-INFO MOD 0038

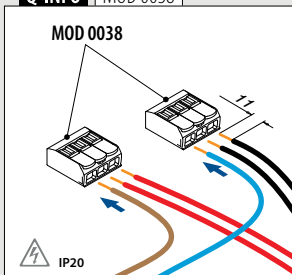

Q-INFO MOD 0038

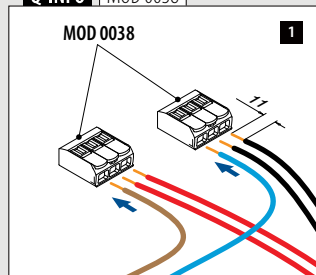

Q-INFO MOD 0037

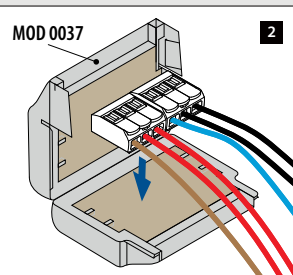

Q-INFO MOD 0037

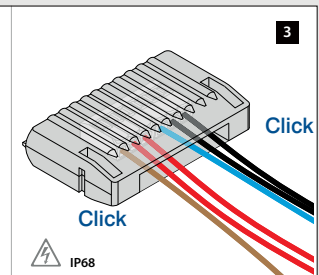

Q-INFO

NOTES DE SÉCURITÉ

- Seuls les électriciens qualifiés sont habilités à installer les modules secteur en respectant et observant les réglementations et normes en vigueur.
- Attention à la polarité. Si elle est incorrecte, le produit peut être endommagé. Seule une connexion en parallèle garantit la sécurité de l'installation.
- Les alimentations électriques utilisées doivent protéger contre tout risque de court-circuit, surcharge ou surchauffe et être sécurisées grâce à une source SELV (source basse tension externe).
- Ne pas dépasser la puissance électrique maximale autorisée.
- Seul les circuits parallèles garantissent un fonctionnement sûr.

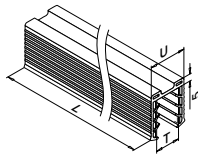
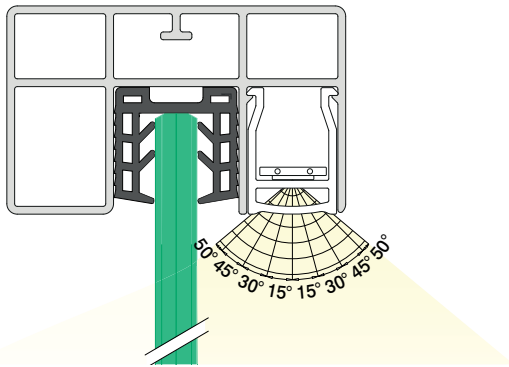

MOD 5124

Accessoires

U = 24 mm

Pour verre monolithique	T	
205124-050-08	8 - 10	L = 5 m
205124-050-11	12	L = 5 m
205124-050-15	15	L = 5 m
205124-050-19	19	L = 5 m

Pour verre feuilleté

205124-050-08	8,76 - 10,76	L = 5 m
205124-050-11	11,52 - 13,52	L = 5 m
205124-050-17	16,76 - 17,52	L = 5 m
NEW 205124-050-92	20,76 - 21,52	L = 5 m

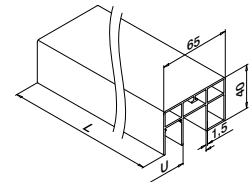
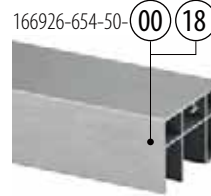

MOD 6926

Aluminium Brut

	U	<input type="checkbox"/>	
166926-654-50-00	24	65 x 40	L = 5 m

Aluminium Brossé, anodisé

OUTDOOR

166926-654-50-18	24	65 x 40	L = 5 m
------------------	----	---------	---------



International Design Modèle Protection

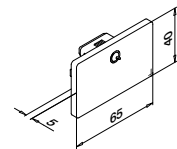

MOD 6734 - EASY HIT®

Aluminium Brut

	Pour <input type="checkbox"/>	
166734-654-00	65 x 40	2

Aluminium Brossé, anodisé

OUTDOOR

166734-654-18	65 x 40	2
---------------	---------	---

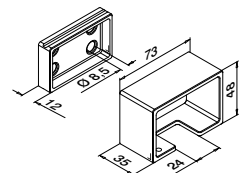

MOD 6545

Aluminium Brut

	Pour <input type="checkbox"/>	
166545-654-00	65 x 40	QS-55 470 / QS-20 472

Aluminium Brossé, anodisé

OUTDOOR

166545-654-18	65 x 40	QS-55 470 / QS-20 472
---------------	---------	-------------------------



International Design Modèle Protection

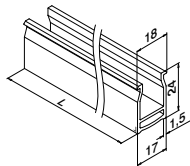

MOD 5091

INDOOR	Transparence	
155091-025-03	Net	L = 2,5 m
155091-025-06	Dépoli	L = 2,5 m

IK10

International Design Modèle Protection

Q-INFO | MOD 6545 / 5124 / 6926

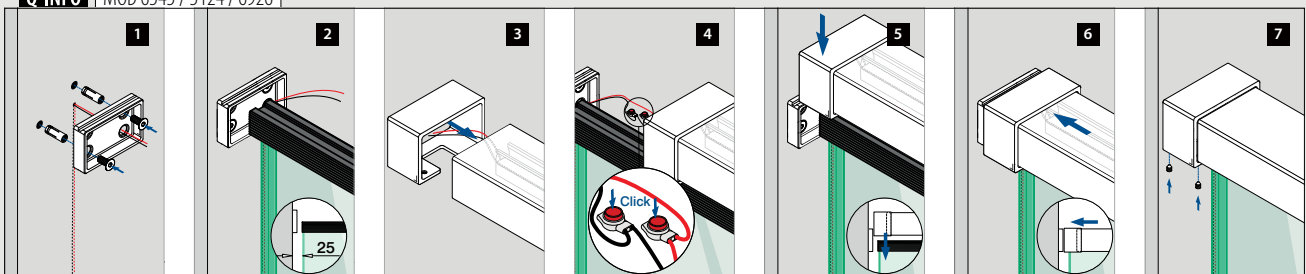

Raccords

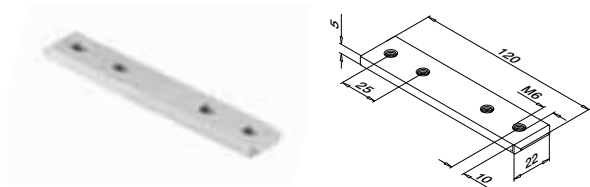

MOD 6795

Aluminium	Brut		
166795-339	QS-261	472	2

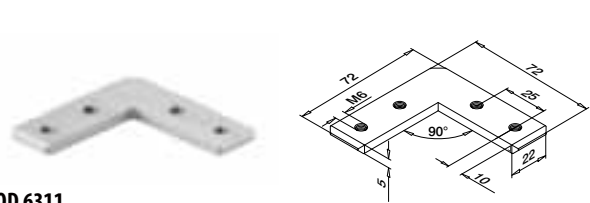

MOD 6311

Aluminium	Brut		
166311-339	QS-261	472	2

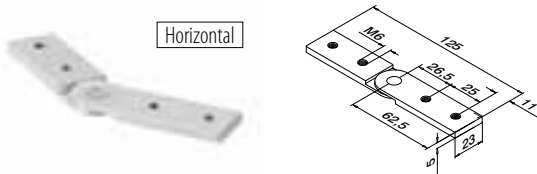

MOD 6797

Aluminium	Brut		
166797	QS-261	472	2

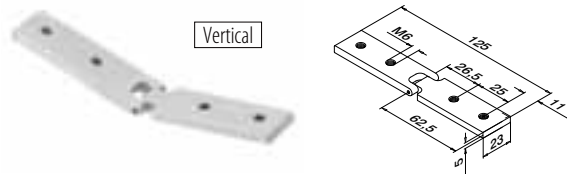

MOD 6798

Aluminium	Brut		
166798	QS-261	472	2

Q-INFO MOD 6311

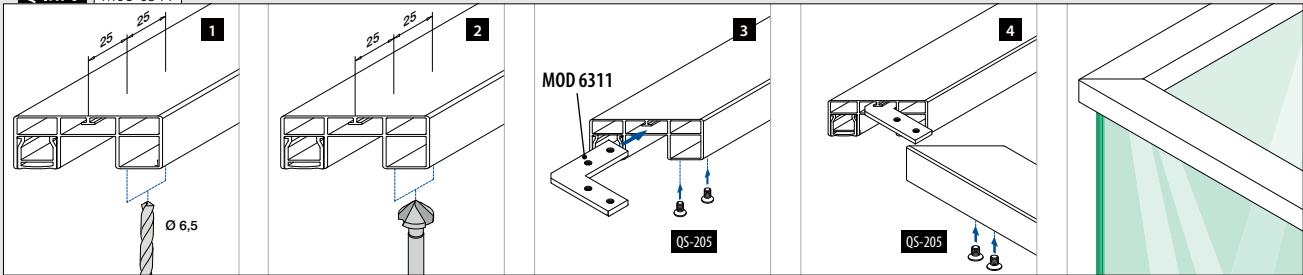

Q-INFO MOD 6797

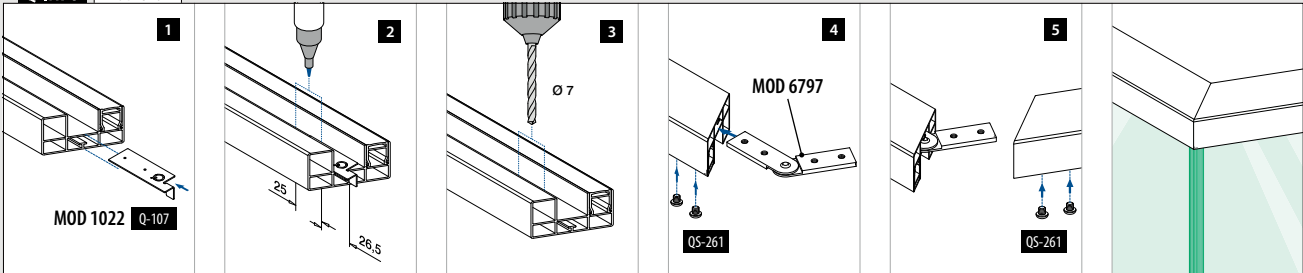

Q-INFO MOD 6798

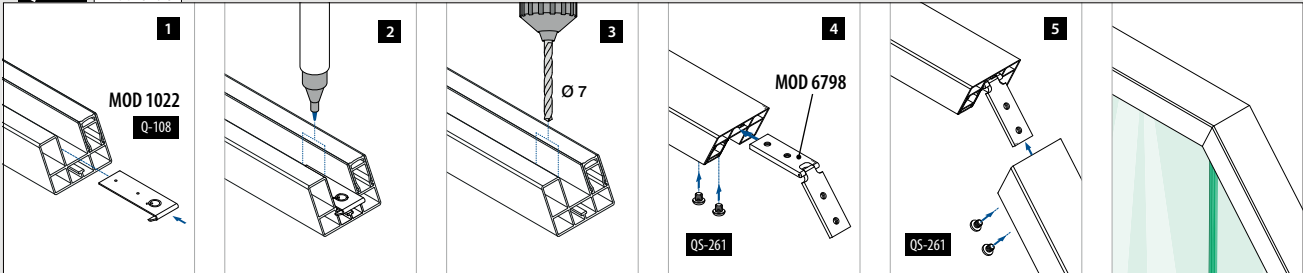

Q-INFO MOD 6798

En haut

Couper	45°	40°	35°	30°	25°	20°	15°	10°	5°	0°
Angle externe	90°	100°	110°	120°	130°	140°	150°	160°	170°	180°
Distance du bord (x)	30,5	30,0	29,5	29,0	28,5	28,0	27,5	27,0	27,0	26,5

En bas

Couper	0°	5°	10°	15°	20°	25°	30°	35°	40°	45°
Angle interne	180°	170°	160°	150°	140°	130°	120°	110°	100°	90°
Distance du bord (x)	26,5	26,5	26,0	26,0	25,5	25,5	25,0	24,5	24,5	24,0

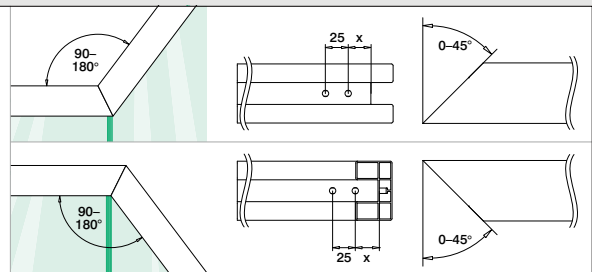

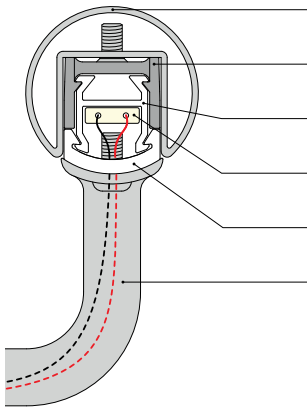

- Tubes à fond de gorge (U = 24) : ■257
- Adaptateurs MOD 078x-24 : ■256
- Section de la gorge : ■257
- Bandes LED : ■238, 245
- Cache pour profil avec LED : ■257
- Supports de main-courante : ■260 - 261
- Adaptateurs pour main-courante MOD 0770 / 0772 : ■262

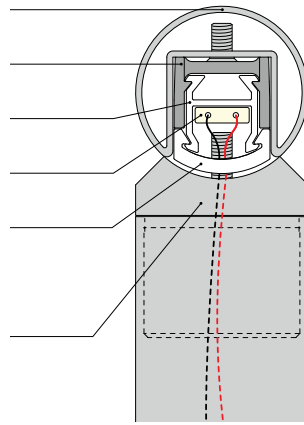

Pour les supports de main courante non ajustables

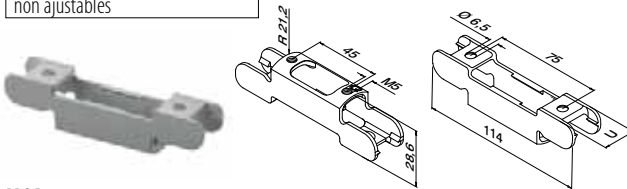

MOD 0781

316	Inox brossé			
OUTDOOR	U			
140781-24	24	QS-205 ■472	2	

International Design Modèle Protection

Pour les supports de main courante ajustables

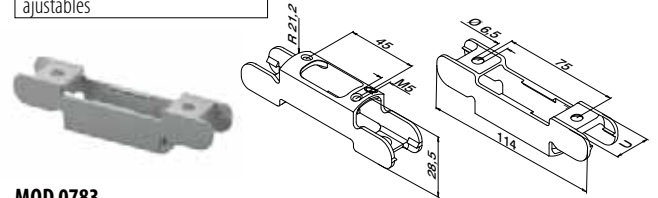

MOD 0783

316	Inox brossé			
OUTDOOR	U			
140783-24	24	QS-205 ■472	2	

International Design Modèle Protection

Pour les adaptateurs pour main-courante non ajustables

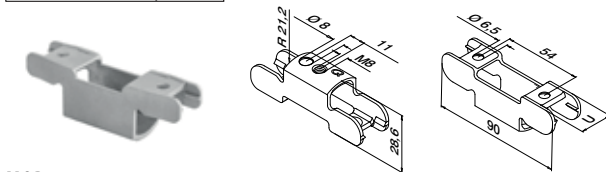

MOD 0782

316	Inox brossé			
OUTDOOR	U			
140782-24	24	QS-205 ■472	2	

International Design Modèle Protection



MOD 0780

316	Inox brossé			
OUTDOOR	U			
140780-24	24	QS-205 ■472	2	

International Design Modèle Protection

Q-INFO | MOD 0780 / 0781

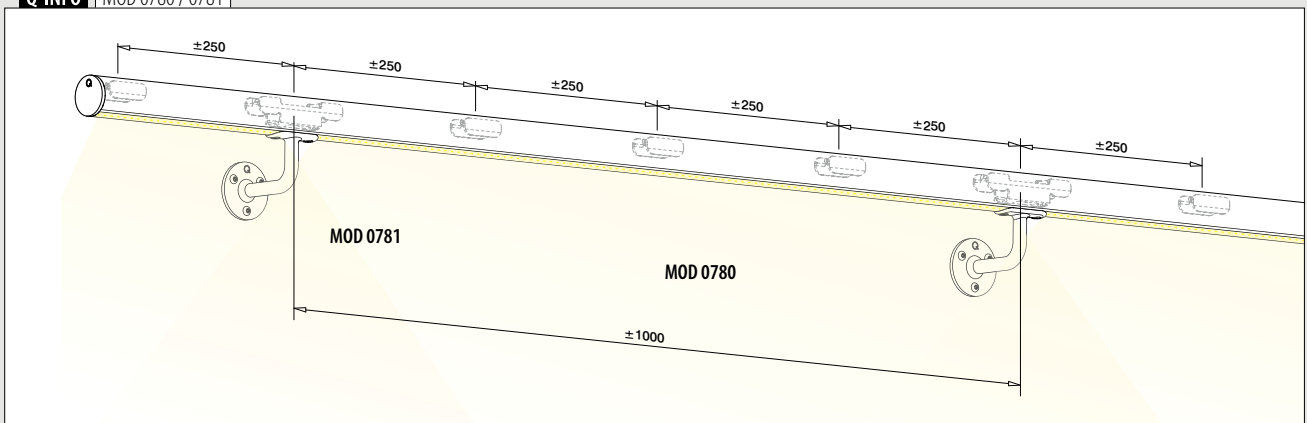

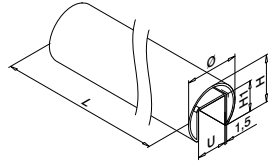

MOD 6920

Ø 42,4 mm

304		Inox brossé				
INDOOR	U	Ø	H	H1		
136920-042-50-12	24	42,4	37	24	L = 5 m	
316		Inox brossé				
OUTDOOR	U	Ø	H	H1		
146920-042-50-12	24	42,4	37	24	L = 5 m	

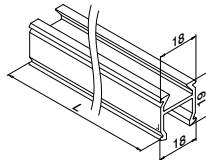

MOD 5092

INDOOR

155092-025

L = 2,5 m

International Design Modèle Protection

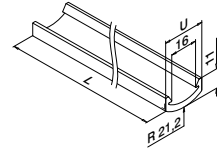

MOD 5090

INDOOR

155090-025-24-03

Transparence

Net

L = 2,5 m

155090-025-24-06

Dépoli

L = 2,5 m

IK10

International Design Modèle Protection

Q-INFO MOD 6920

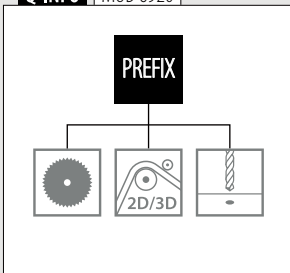

MOD 6950
(U = 24 mm)
 169

MOD 6924
(U = 24 mm)
 176 - 182

Q-INFO MOD 078x

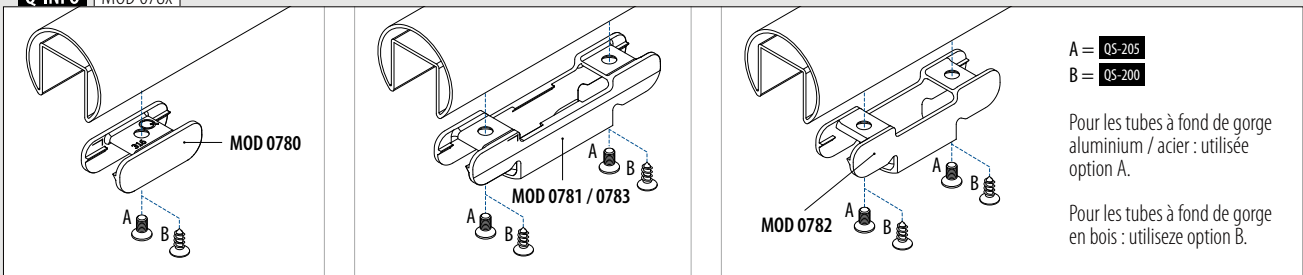

Q-INFO MOD 0783

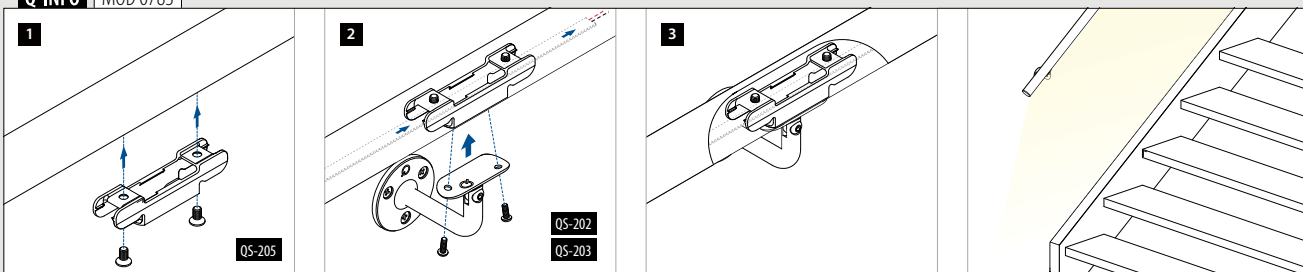

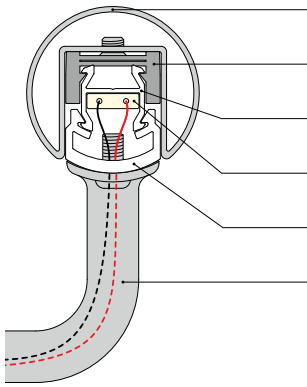

- Tubes à fond de gorge (U = 27) : ■259
- Adaptateurs MOD 078x-27 : ■258
- Section de la gorge : ■259
- Bandes LED : ■238, 245
- Cache pour profil avec LED : ■259
- Supports de main-courante : ■260 - 261
- Adaptateurs pour main-courante MOD 0771 / 0773 : ■262

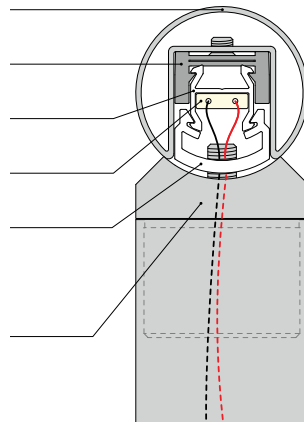

Pour les supports de main courante non ajustables

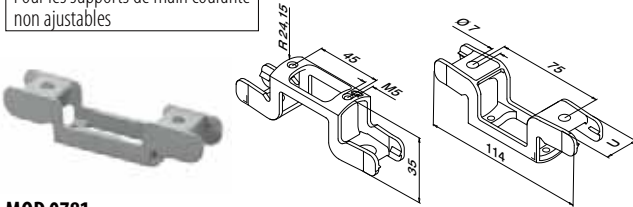

MOD 0781

316	Inox brossé		
OUTDOOR	U		
140781-27	27	QS-205 ■472	2

International Design Modèle Protection

Pour les supports de main courante ajustables

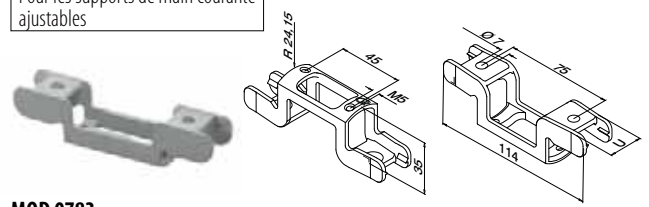

MOD 0783

316	Inox brossé		
OUTDOOR	U		
140783-27	27	QS-205 ■472	2

International Design Modèle Protection

Pour les adaptateurs pour main-courante non ajustables

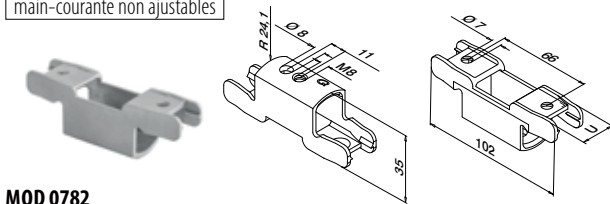

MOD 0782

316	Inox brossé		
OUTDOOR	U		
140782-27	27	QS-205 ■472	2

International Design Modèle Protection



MOD 0780

316	Inox brossé		
OUTDOOR	U		
140780-27	27	QS-205 ■472	2

International Design Modèle Protection

Q-INFO | MOD 0780 / 0781

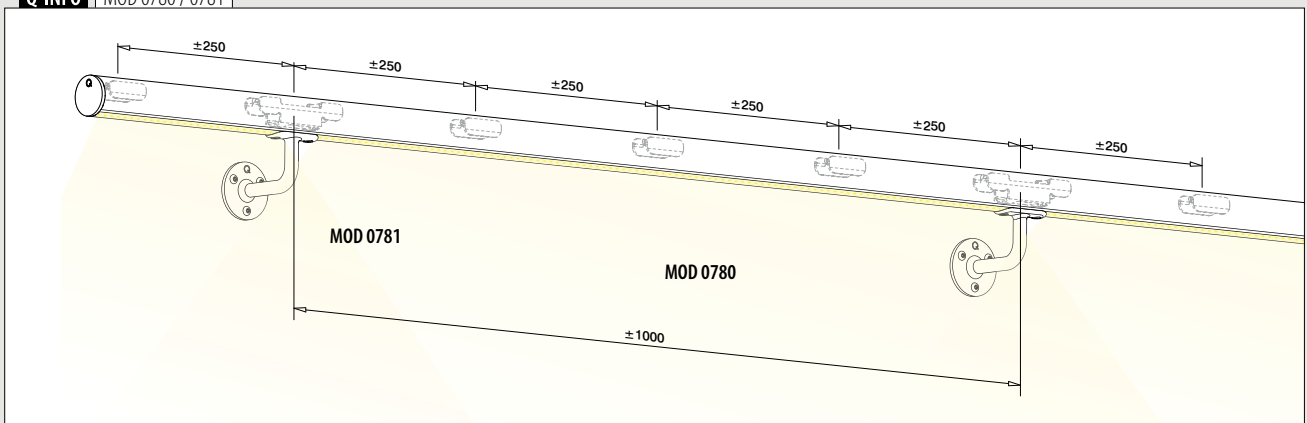

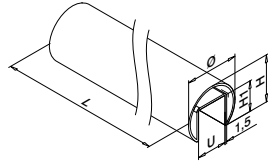

MOD 6920

Ø 48,3 mm

	304	Inox brossé				
	INDOOR	U	U	H	H1	
	136920-048-50-12	27	48,3	42,6	30	L = 5 m
	316	Inox brossé				
	OUTDOOR	U	U	H	H1	
	146920-048-50-12	27	48,3	42,6	30	L = 5 m

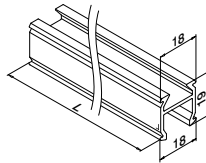

MOD 5092

INDOOR

155092-025		L = 2,5 m
------------	--	-----------

International Design Modèle Protection

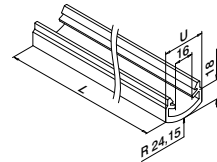

MOD 5090

INDOOR

Transparence

155090-025-27-03	Net		L = 2,5 m
155090-025-27-06	Dépoli		L = 2,5 m

IK10

International Design Modèle Protection

Q-INFO MOD 078x

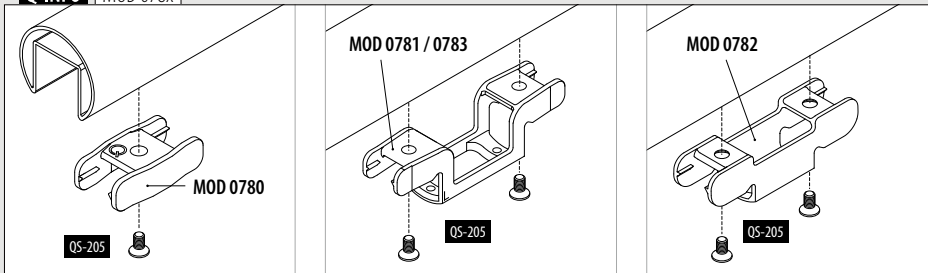

Q-INFO MOD 6920

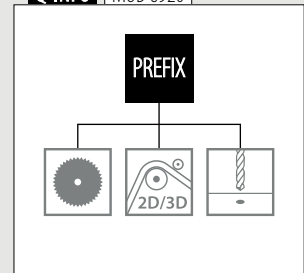

Q-INFO MOD 0783

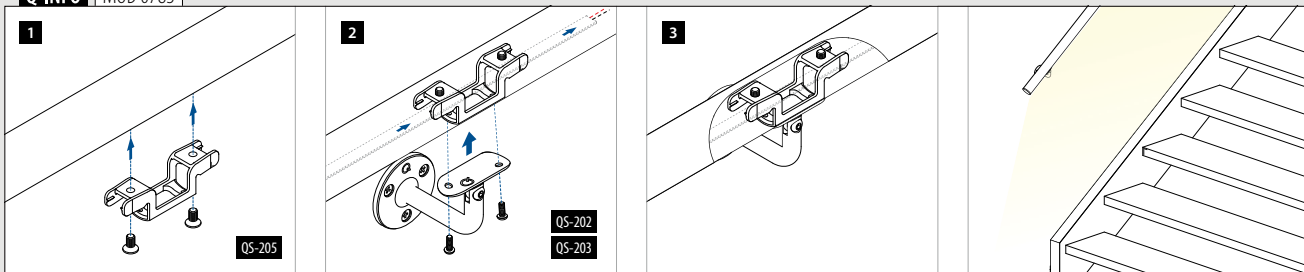

Avec passe-câble

Pour tube rond

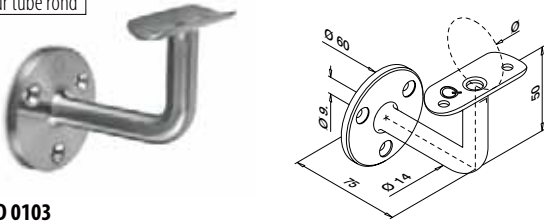
**MOD 0103****304**

Inox brossé

INDOOR

Code	Ø	Accessoire	Accessoire	Accessoire	Quantité
130103-042-12	42,4	MOD 0781-24	QS-7	471 / QS-202	472 2
130103-048-12	48,3	MOD 0781-27	QS-7	471 / QS-202	472 2

316

Inox brossé

OUTDOOR

140103-042-12	42,4	MOD 0781-24	QS-50	471 / QS-203	472 2
140103-048-12	48,3	MOD 0781-27	QS-50	471 / QS-203	472 2

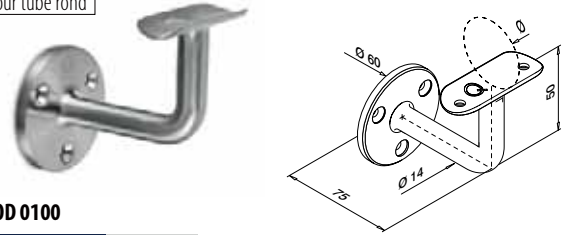

Pour tube rond

**MOD 0100****304**

Inox brossé

INDOOR

Code	Ø	Accessoire	Accessoire	Accessoire	Quantité
130100-042-12	42,4	MOD 0781-24	QS-7	471 / QS-202	472 2
130100-048-12	48,3	MOD 0781-27	QS-7	471 / QS-202	472 2

316

Inox brossé

OUTDOOR

140100-042-12	42,4	MOD 0781-24	QS-50	471 / QS-203	472 2
140100-048-12	48,3	MOD 0781-27	QS-50	471 / QS-203	472 2



Mains-courantes

Supports de main-courante

Fixation sur le verre

Pour tube rond

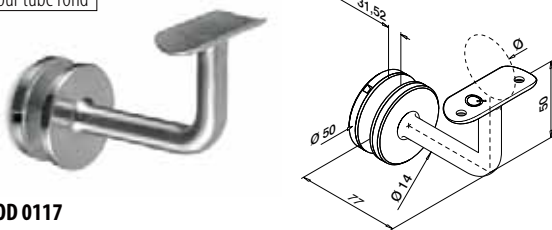
**MOD 0117****304**

Inox brossé

INDOOR

Code	Ø	Accessoire	Accessoire	Accessoire	Quantité
130117-042-12	42,4	MOD 0781-24	QS-202	472	2
130117-048-12	48,3	MOD 0781-27	QS-202	472	2

316

Inox brossé

OUTDOOR

140117-042-12	42,4	MOD 0781-24	QS-203	472	2
140117-048-12	48,3	MOD 0781-27	QS-203	472	2

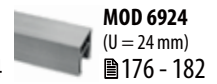
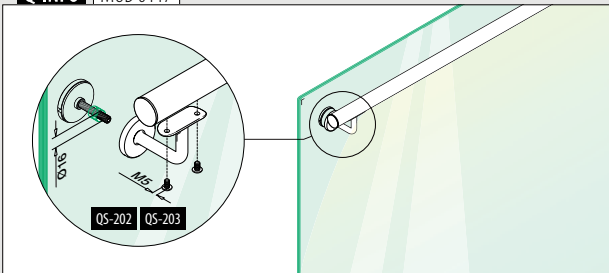
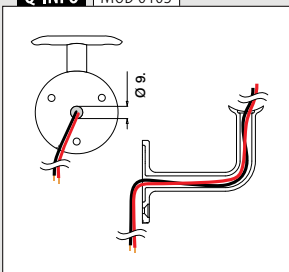
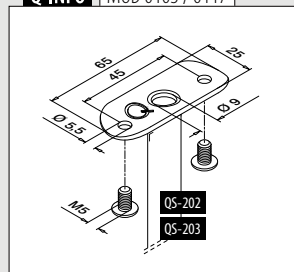
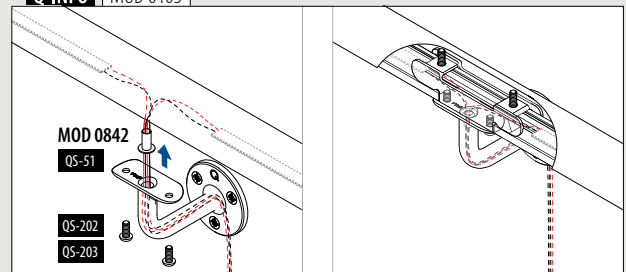
**SPOTLIGHT****MOD 0900**Ø 42,4 x 2,0 / 48,3 x 2,0
351**MOD 0900**Ø 42,4 x 2,0
367**LINEAR LIGHT****MOD 6950**(U = 24 mm)
169**MOD 6920**(U = 24 mm)
170, 174**MOD 6924**(U = 24 mm)
176 - 182**MOD 6920**(U = 27 mm)
170**Q-INFO** MOD 0117**Q-INFO** MOD 0103**Q-INFO** MOD 0103 / 0117**Q-INFO** MOD 0103

Supports de main-courante

Montage sur les poteaux

Pour tube rond
Avec passe-câble

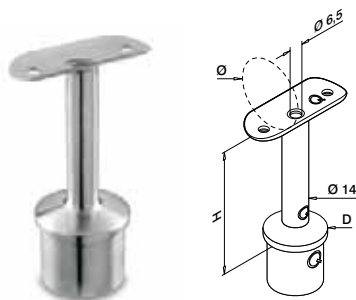

MOD 0710

316		Inox brossé					
OUTDOOR	D	Ø	H	Ø	H	Ø	H
140710-042-01-12	42,4 x 2,0	42,4	MOD 0781-24	79	QS-203 472	2	

MOD 0711

316		Inox brossé					
OUTDOOR	D	Ø	H	Ø	H	Ø	H
140711-048-01-12	48,3 x 2,0	48,3	MOD 0781-27	80	QS-203 472	2	



Pour tube rond

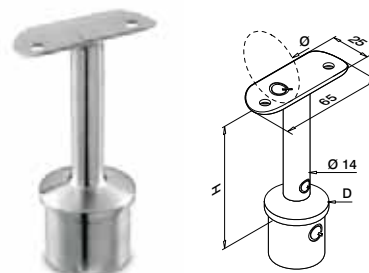

MOD 0710

304		Inox brossé					
INDOOR	D	Ø	H	Ø	H	Ø	H
130710-042-00-12	42,4 x 2,0	42,4	MOD 0781-24	79	QS-202 472	2	

316		Inox brossé					
OUTDOOR	D	Ø	H	Ø	H	Ø	H
140710-042-00-12	42,4 x 2,0	42,4	MOD 0781-24	79	QS-203 472	2	

MOD 0711

304		Inox brossé					
INDOOR	D	Ø	H	Ø	H	Ø	H
130711-048-00-12	48,3 x 2,0	48,3	MOD 0781-27	80	QS-202 472	2	

316		Inox brossé					
OUTDOOR	D	Ø	H	Ø	H	Ø	H
140711-048-00-12	48,3 x 2,0	48,3	MOD 0781-27	80	QS-203 472	2	



Supports de main-courante

Orientables

Montage sur les poteaux

Pour tube rond

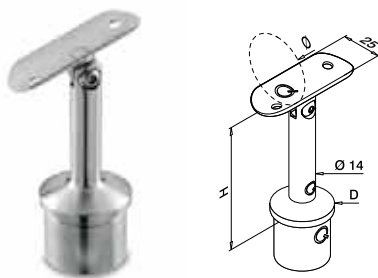

MOD 0718

304		Inox brossé					
INDOOR	D	Ø	H	Ø	H	Ø	H
130718-042-12	42,4 x 2,0	42,4	MOD 0783-24	79	QS-202 472	2	

316		Inox brossé					
OUTDOOR	D	Ø	H	Ø	H	Ø	H
140718-042-12	42,4 x 2,0	42,4	MOD 0783-24	79	QS-203 472	2	

MOD 0719

304		Inox brossé					
INDOOR	D	Ø	H	Ø	H	Ø	H
130719-048-12	48,3 x 2,0	48,3	MOD 0783-27	80	QS-202 472	2	

316		Inox brossé					
OUTDOOR	D	Ø	H	Ø	H	Ø	H
140719-048-12	48,3 x 2,0	48,3	MOD 0783-27	80	QS-203 472	2	

Q-INFO | MOD 0710 / 0711-04x-01

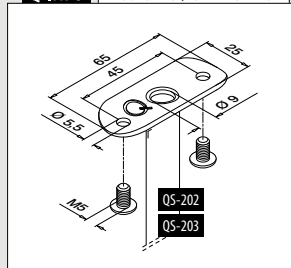

Q-INFO | MOD 0710 / 0711-04x-00

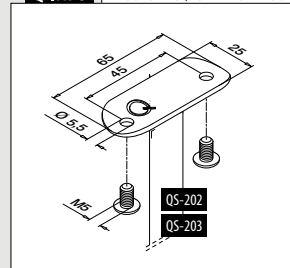

Q-INFO | MOD 0710 / 0711-04x-01

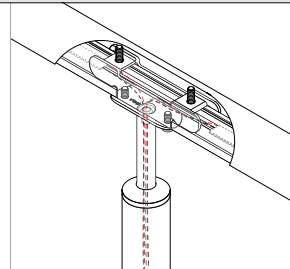
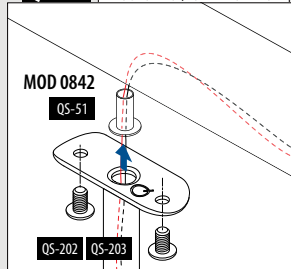

Q-INFO | MOD 0710 / 0711-04x-01

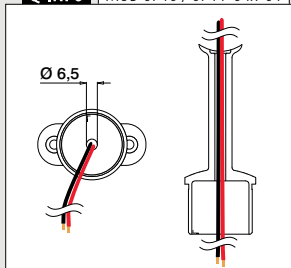

Q-INFO | MOD 0718 / 0719

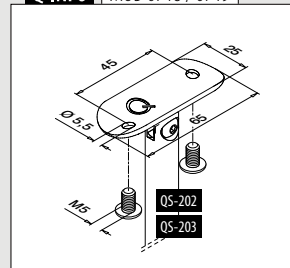

Avec passe-câble

Pour tube rond

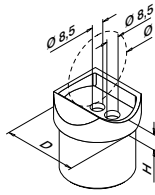
**MOD 0770**

304		Inox brossé					
INDOOR	D	Ø	H				
130770-042-12	42,4 x 2,0	42,4	MOD 0782-24	9	QS-26	472	2

316		Inox brossé					
OUTDOOR	D	Ø	H				
140770-042-12	42,4 x 2,0	42,4	MOD 0782-24	9	QS-27	472	2

MOD 0772

304		Inox brossé					
INDOOR	D	Ø	H				
SELL OUT 130772-042-12	42,4 x 2,6	42,4	MOD 0782-24	9	QS-26	472	2

316		Inox brossé					
OUTDOOR	D	Ø	H				
SELL OUT 140772-042-12	42,4 x 2,6	42,4	MOD 0782-24	9	QS-27	472	2

MOD 0771

304		Inox brossé					
INDOOR	D	Ø	H				
130771-048-12	48,3 x 2,0	48,3	MOD 0782-27	11	QS-26	472	2

316		Inox brossé					
OUTDOOR	D	Ø	H				
140771-048-12	48,3 x 2,0	48,3	MOD 0782-27	11	QS-27	472	2

MOD 0773

304		Inox brossé					
INDOOR	D	Ø	H				
130773-048-12	48,3 x 2,6	48,3	MOD 0782-27	11	QS-26	472	2

316		Inox brossé					
OUTDOOR	D	Ø	H				
140773-048-12	48,3 x 2,6	48,3	MOD 0782-27	11	QS-27	472	2



International Design Modèle Protection

SELL OUT Seulement jusqu'à épuisement des stocks.

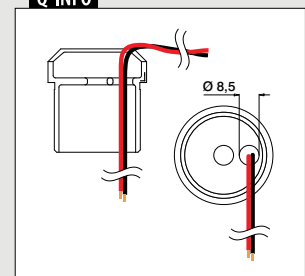
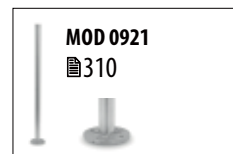
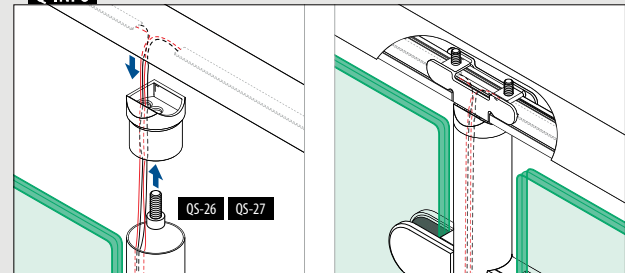
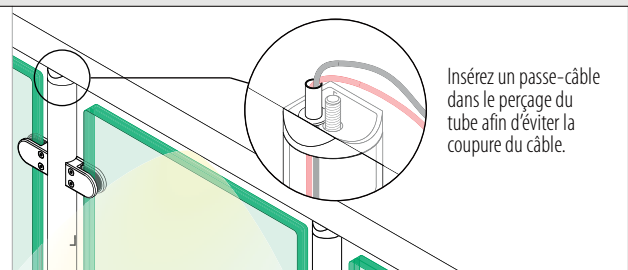
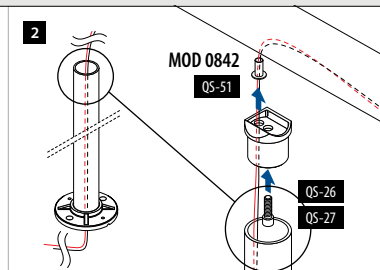
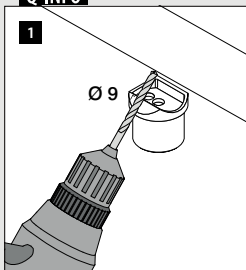
Q-INFO**Q-INFO****Q-INFO**

Insérez un passe-câble dans le perçage du tube afin d'éviter la coupure du câble.

Mains-courantes

Tubes à fond de gorge

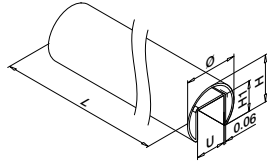

MOD 6920

Ø 42,4 mm

304		Inox brossé			
INDOOR	U	H	H1		
136920-042-50-12	24	37	24		L = 5 m
316		Inox brossé			
OUTDOOR	U	H	H1		
146920-042-50-12	24	37	24		L = 5 m

Ø 48,3 mm

304		Inox brossé			
INDOOR	U	H	H1		
136920-048-50-12	27	42,6	30		L = 5 m
316		Inox brossé			
OUTDOOR	U	H	H1		
146920-048-50-12	27	42,6	30		L = 5 m



Mains-courantes

Raccords tubes à fond de gorge vers tube

Orientables

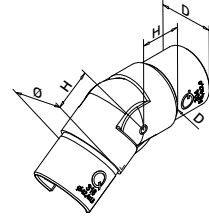

MOD 6304

316		Inox brossé			
OUTDOOR	Ø	D	H		
146304-242-01-12	42,4 x 1,5	42,4 x 2,0	27		2
146304-248-01-12	48,3 x 1,5	48,3 x 2,0	30		2
146304-048-01-12	48,3 x 1,5	48,3 x 2,6	30		2

NEW

Mains-courantes

Raccords pour tube à fond de gorge

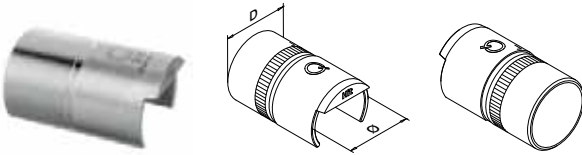

MOD 5793 - EASY HIT®

316		Brut		
OUTDOOR	Pour tube Ø	Pour tube D		
145793-042	42,4 x 1,5	42,4 x 2,0		2
145793-048	48,3 x 1,5	48,3 x 2,0		2



International Design Modèle Protection

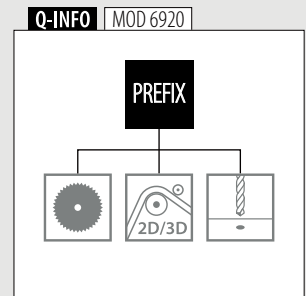
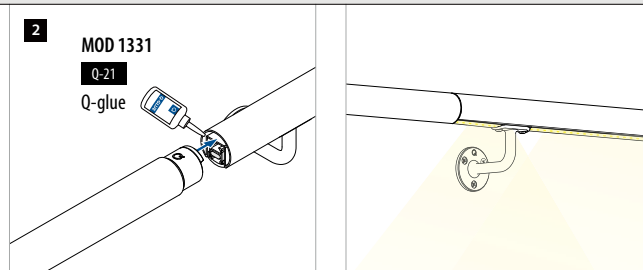
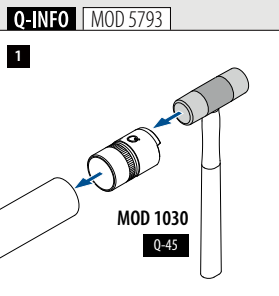
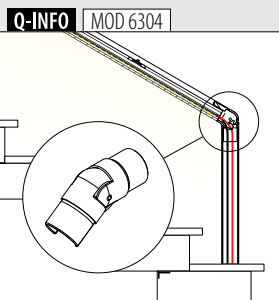

Raccords

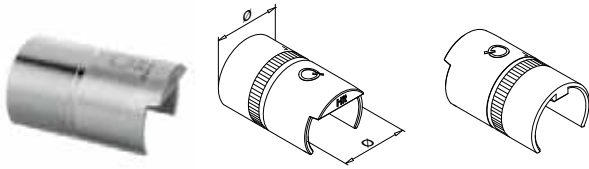

MOD 6792 - EASY HIT®

304		Brut	
INDOOR	Pour Ø		
136792-042	42,4 x 1,5		2
136792-048	48,3 x 1,5		2
316		Brut	
OUTDOOR			
146792-042	42,4 x 1,5		2
146792-048	48,3 x 1,5		2



MOD 6313

304		Inox brossé	
INDOOR	Pour Ø	H	
136313-042-12	42,4 x 1,5	30	2
136313-048-12	48,3 x 1,5	35	2
316		Inox brossé	
OUTDOOR			
146313-042-12	42,4 x 1,5	30	2
146313-048-12	48,3 x 1,5	35	2



Raccords

Orientables



MOD 6302

304		Inox brossé	
INDOOR	Pour Ø	H	
136302-042-02-12	42,4 x 1,5	30	2
136302-048-02-12	48,3 x 1,5	35	2
316		Inox brossé	
OUTDOOR			
146302-042-02-12	42,4 x 1,5	30	2
146302-048-02-12	48,3 x 1,5	35	2



MOD 6302

304		Inox brossé	
INDOOR	Pour Ø	H	
136302-042-01-12	42,4 x 1,5	30	2
136302-048-01-12	48,3 x 1,5	35	2
316		Inox brossé	
OUTDOOR			
146302-042-01-12	42,4 x 1,5	30	2
146302-048-01-12	48,3 x 1,5	35	2



MOD 6312

304		Inox brossé	
INDOOR	Ø	H	
136312-042-12	42,4 x 1,5	27	2
136312-048-12	48,3 x 1,5	30	2
316		Inox brossé	
OUTDOOR			
146312-042-12	42,4 x 1,5	27	2
146312-048-12	48,3 x 1,5	30	2

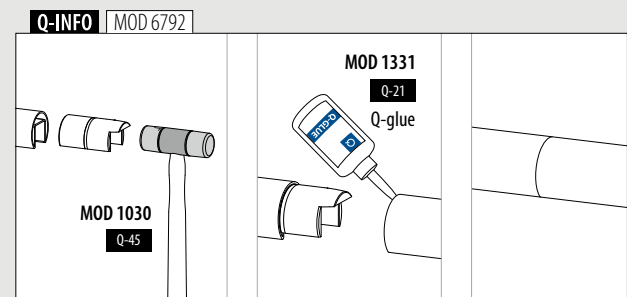

Embouts



MOD 6732

304 Inox brossé

INDOOR	Pour Ø	
136732-042-12	42,4 x 1,5	2
136732-048-12	48,3 x 1,5	2

316 Inox brossé

OUTDOOR		
146732-042-12	42,4 x 1,5	2
146732-048-12	48,3 x 1,5	2



Retour mural

Gauche / droite Avec passe-câble

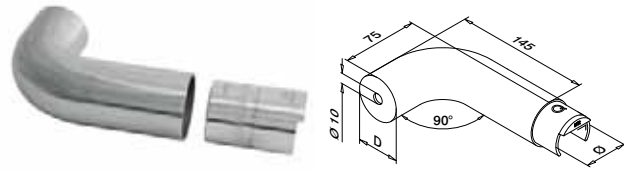

MOD 6739

316 Inox brossé

OUTDOOR	D	Pour Ø	
146739-042-12	42,4	42,4 x 1,5	2
146739-048-12	48,3	48,3 x 1,5	2



Embases murales pour tube

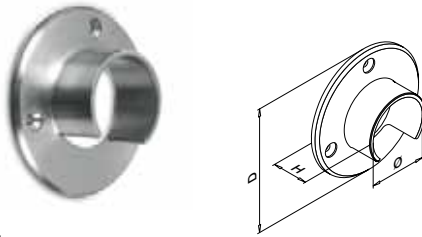

MOD 6505

304 Inox brossé

INDOOR	Ø	D	H		
136505-042-12	42,4	90	30	QS-5	471 2
136505-048-12	48,3	95	35	QS-5	471 2

316 Inox brossé

OUTDOOR					
146505-042-12	42,4	90	30	QS-6	471 2
146505-048-12	48,3	95	35	QS-6	471 2



Avec passe-câble

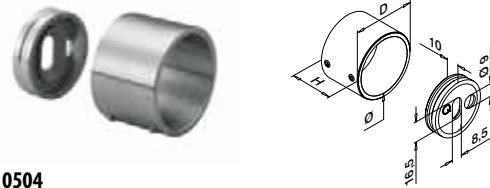

MOD 0504

304 Inox brossé

INDOOR	Ø	D	H		
130504-042-12	42,4	50	35	QS-55	470 / QS-21 472 2
130504-048-12	48,3	56	35	QS-55	470 / QS-21 472 2

316 Inox brossé

OUTDOOR					
140504-042-12	42,4	50	35	QS-55	470 / QS-22 472 2
140504-048-12	48,3	56	35	QS-55	470 / QS-22 472 2



Q-INFO MOD 6739

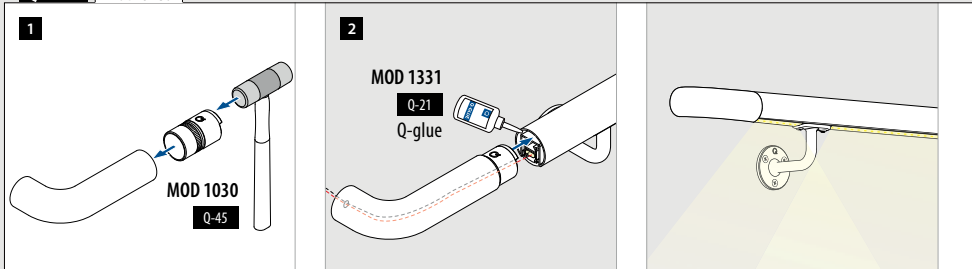

Q-INFO MOD 6739

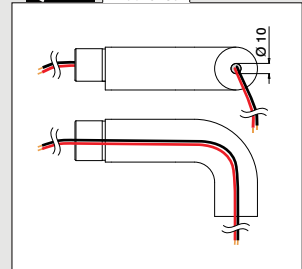

Q-INFO MOD 0504

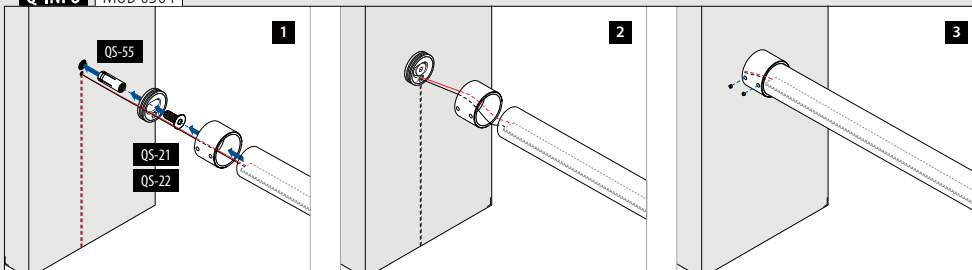

Q-INFO MOD 0504

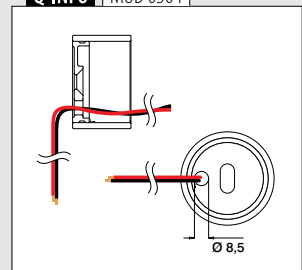

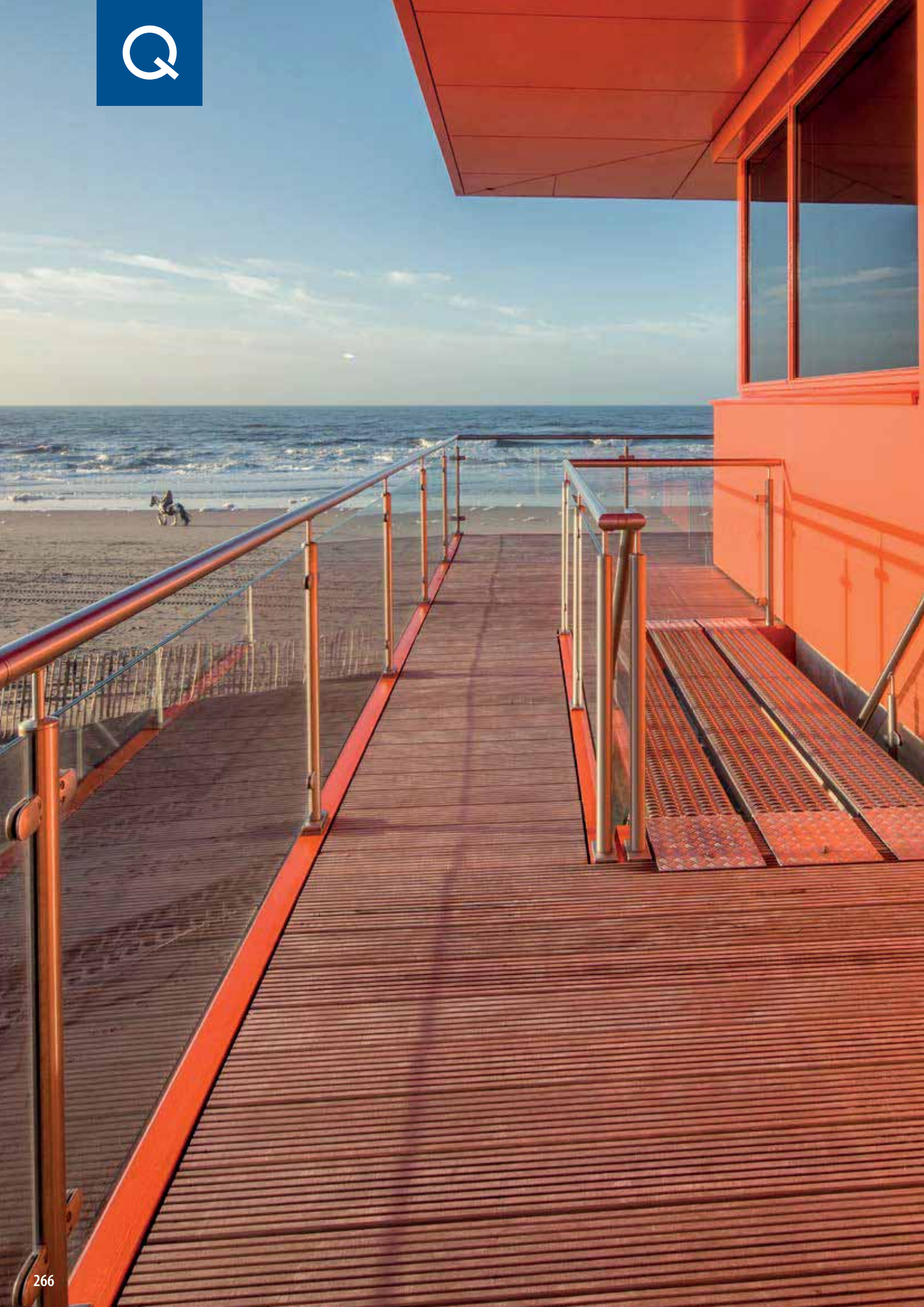

4

SYSTÈMES DE GARDE-CORPS À POTEAUX

Easy Alu	268 - 281
Square Line® 40x10	282 - 283
Square Line® 40x20	284 - 287
Square Line® 40x40	288 - 301
Square Line® 60x30	302 - 307
Q-line	308 - 359
Barrier Line	360 - 361
Q-line poli miroir	362 - 371
Pièces à souder	372 - 379
Bendywood	382 - 383
Naturail	384 - 385
Remplissages	386 - 419



EASY ALU

Conçu pour : Utilisation faible à moyenne
Utilisation : Intérieur et extérieur
Variantes : Montage au sol et latéral
Applications : Balcons, galeries, passerelles,
cloisons, escaliers, pare-vents,
et protection de fenêtres

Matériau : Aluminium (brut, brossé
anodisé ou thermolaqué)

Épaisseur de verre : 8 à 10,76 mm

Retrouvez toutes les informations
sur Easy Alu en ligne :



[https://q-ne.ws/
EasyAlu23](https://q-ne.ws/EasyAlu23)



Installation rapide, confort extrême

Easy Alu vous offre tous les avantages d'un garde-corps en aluminium robuste et esthétique avec la qualité Q-railing. Il est de surcroît très élégant, économique et peut être largement personnalisé. Vous pouvez choisir de préassembler ses composants pour créer des sections de garde-corps complètes dans votre atelier. Vous pouvez également aller encore plus vite en commandant des modules personnalisés prêts à installer. Fixez-les tout simplement au sol... C'est terminé !

Easy Alu	BE Montage au sol	BE Montage latéral
Max. charge linéaire (kN/m)	1,0	0,5
Dist. max. entre poteaux (mm)	1272	1072

Merci de prendre en considération les spécifications de chaque certificat telles qu'épaisseur du verre, fixation. Pour plus d'informations, rendez-vous sur notre site internet, www.q-railing.com/certificat

Tests/calculs/certificats internationaux:



- 1 Inclut le caoutchouc Glass Wing : insérez le panneau rapidement et pratiquement sans forcer. La forme du caoutchouc enserrera fermement le verre.
- 2 Choisissez une des 3 options de commande.
- 3 Fourni avec un bloc de nivellement pour surfaces inégales.

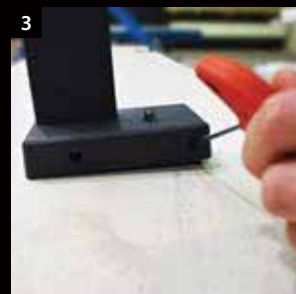

REPLISSAGES EASY ALU

Verre

- Tout en verre
- Verre avec rail supplémentaire

Disponible sur demande :

- Remplissage de rambarde à barreaux
- Remplissage en panneaux de tôle



386 - 387

3 OPTIONS DE COMMANDE

281



Poteaux, montage au sol

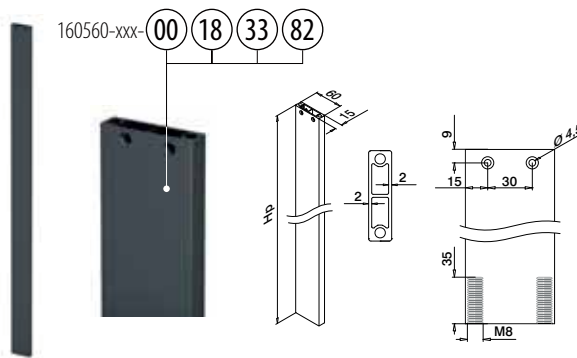
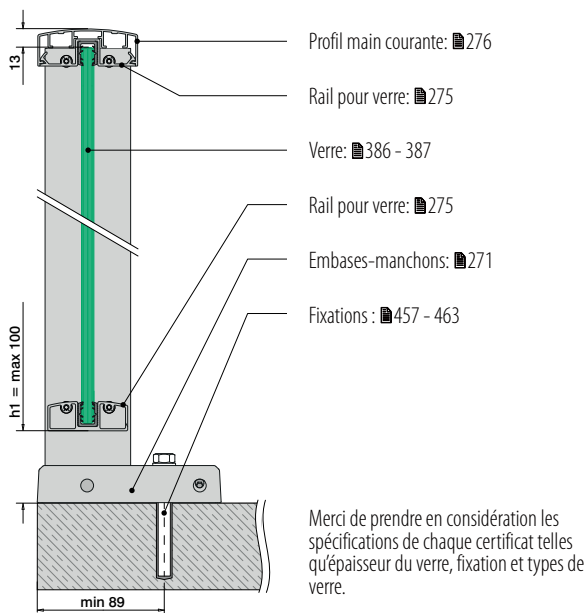

MOD 0560

Aluminium	Brut	Hp		
160560-087-00		865	QS-30	472 1
160560-097-00		965	QS-30	472 1
160560-107-00		1065	QS-30	472 1
160560-117-00		1165	QS-30	472 1

Aluminium	Brossé, anodisé	OUTDOOR		
160560-087-18		865	QS-30	472 1
160560-097-18		965	QS-30	472 1
160560-107-18		1065	QS-30	472 1
160560-117-18		1165	QS-30	472 1

Aluminium	Thermolaqué RAL 7016, texture	OUTDOOR		
160560-087-33		865	QS-30	472 1
160560-097-33		965	QS-30	472 1
160560-107-33		1065	QS-30	472 1
160560-117-33		1165	QS-30	472 1

Aluminium	Black Line	OUTDOOR		
NEW 160560-087-82		865	QS-30	472 1
NEW 160560-097-82		965	QS-30	472 1
NEW 160560-107-82		1065	QS-30	472 1
NEW 160560-117-82		1165	QS-30	472 1



Base de calcul – poteaux, montage au sol

Hauteur garde corps (H) – 35 mm = hauteur poteau (Hp)

Hauteur garde corps (H)	Hauteur poteau (Hp)
900 mm	865 mm
1000 mm	965 mm
1100 mm	1065 mm
1200 mm	1165 mm

SYSTÈMES DE GARDE-CORPS À POTEAUX

EASY ALU

Q-INFO

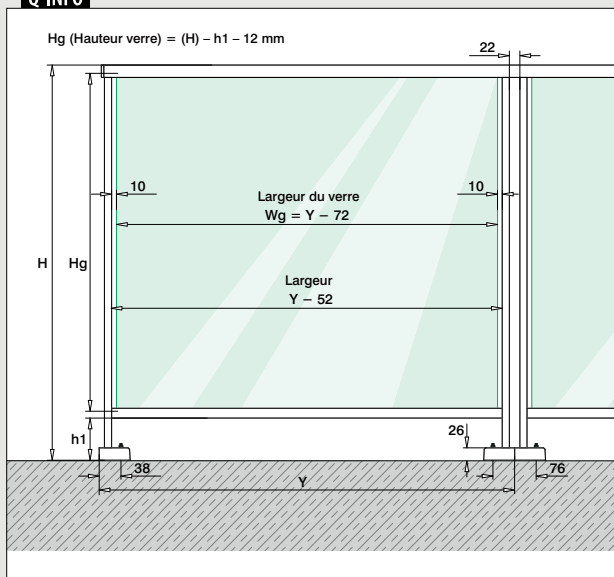

Q-INFO Aluminium

00 Brut	18 Brossé, anodisé	33 RAL 7016 Thermolaqué	82 RAL 9005 Thermolaqué
		Gris anthracite, mat, texture	Noir, mat, texture

Q-INFO

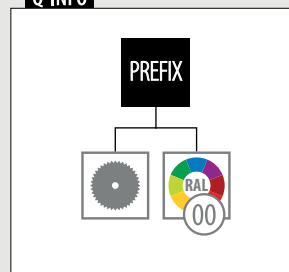

Embases-manchons

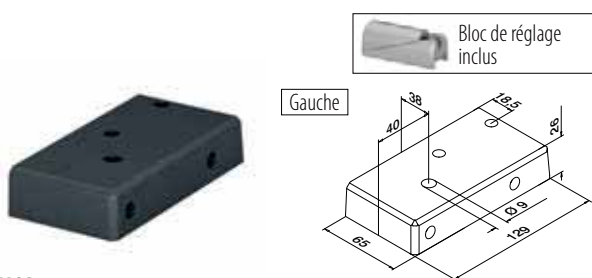

MOD 9026

Aluminium	Brut		
169026-009-01-00		457 - 463	1
Aluminium	Brossé, anodisé		
OUTDOOR			
169026-009-01-18		457 - 463	1
Aluminium	Thermolaqué RAL 7016, texture		
OUTDOOR			
169026-009-01-33		457 - 463	1
Aluminium	Black Line		
OUTDOOR			
NEW		169026-009-01-82	457 - 463 1

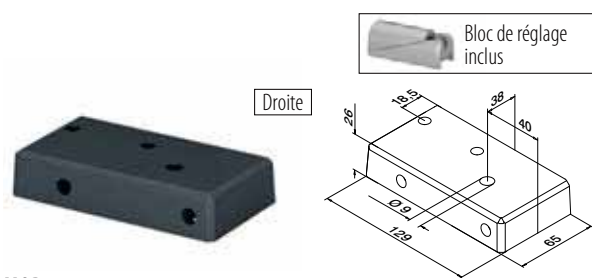

MOD 9026

Aluminium	Brut		
169026-009-02-00		457 - 463	1
Aluminium	Brossé, anodisé		
OUTDOOR			
169026-009-02-18		457 - 463	1
Aluminium	Thermolaqué RAL 7016, texture		
OUTDOOR			
169026-009-02-33		457 - 463	1
Aluminium	Black Line		
OUTDOOR			
NEW		169026-009-02-82	457 - 463 1

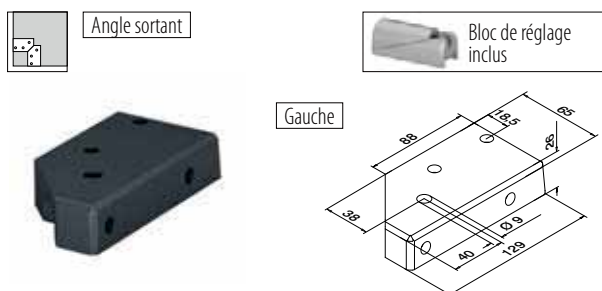

MOD 9026

Aluminium	Brut		
169026-009-91-00		457 - 463	1
Aluminium	Brossé, anodisé		
OUTDOOR			
169026-009-91-18		457 - 463	1
Aluminium	Thermolaqué RAL 7016, texture		
OUTDOOR			
169026-009-91-33		457 - 463	1
Aluminium	Black Line		
OUTDOOR			
NEW		169026-009-91-82	457 - 463 1

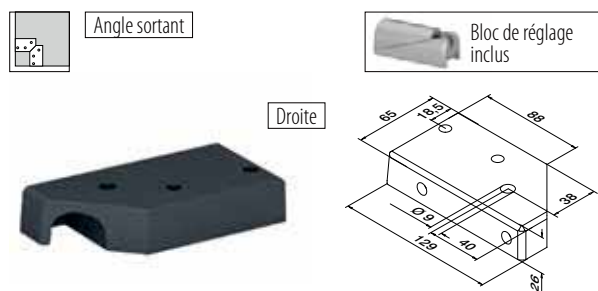

MOD 9026

Aluminium	Brut		
169026-009-92-00		457 - 463	1
Aluminium	Brossé, anodisé		
OUTDOOR			
169026-009-92-18		457 - 463	1
Aluminium	Thermolaqué RAL 7016, texture		
OUTDOOR			
169026-009-92-33		457 - 463	1
Aluminium	Black Line		
OUTDOOR			
NEW		169026-009-92-82	457 - 463 1

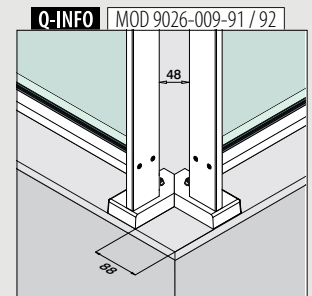
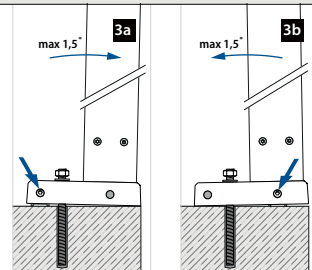
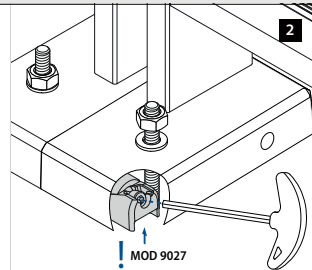
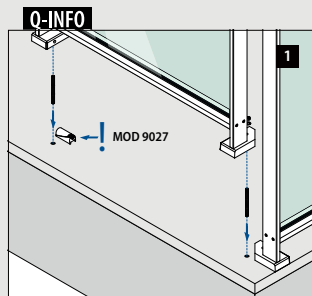



EASY ALU

Poteaux, montage latéral

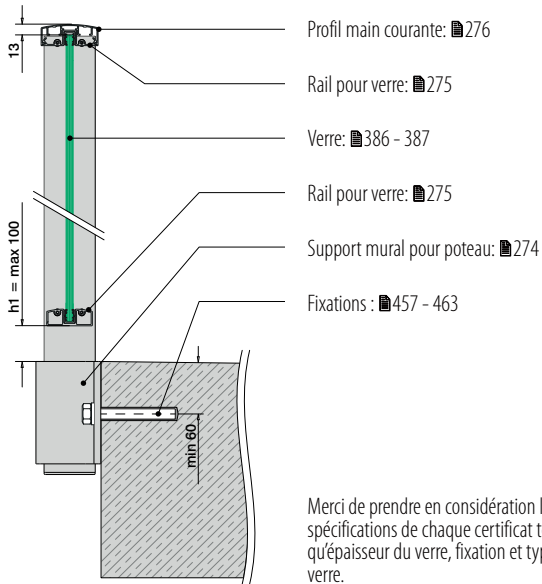

Base de calcul - poteaux, montage latéral

Hauteur garde corps (H) + 140 mm = hauteur poteau (Hp)

Hauteur garde corps (H)	Hauteur poteau (Hp)
900 mm	1040 mm
1000 mm	1140 mm
1100 mm	1240 mm
1200 mm	1340 mm

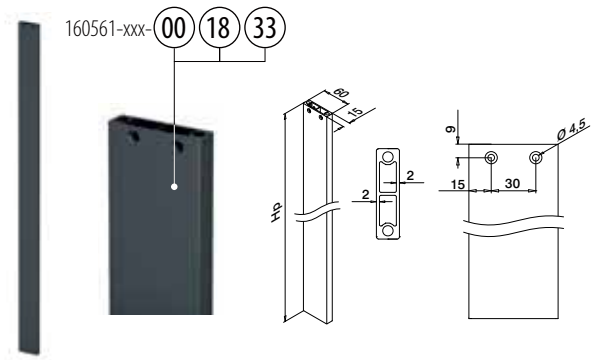

MOD 0561

Aluminium Brut	Hp	
160561-104-00	1040	1
160561-114-00	1140	1
160561-124-00	1240	1
160561-134-00	1340	1

Aluminium Brossé, anodisé OUTDOOR	Hp	
160561-104-18	1040	1
160561-114-18	1140	1
160561-124-18	1240	1
160561-134-18	1340	1

Aluminium Thermolaqué RAL 7016 OUTDOOR	Hp	
160561-104-33	1040	1
160561-114-33	1140	1
160561-124-33	1240	1
160561-134-33	1340	1



Q-INFO

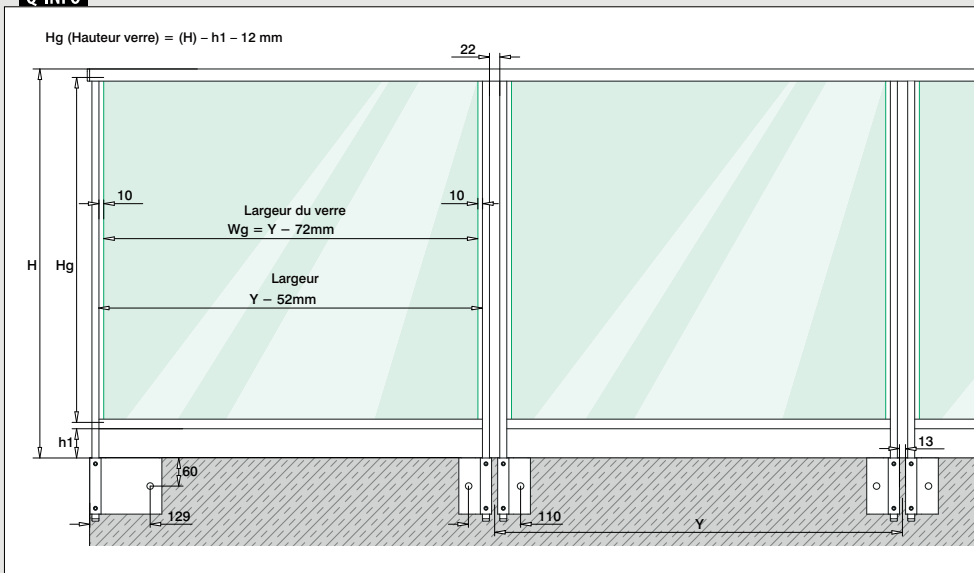

Q-INFO

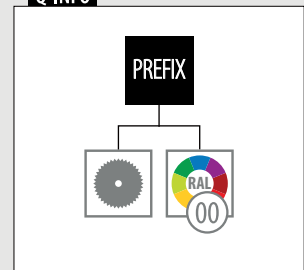

Support mural pour poteau, montage latéral



Angle rentrant



Gauche / droite

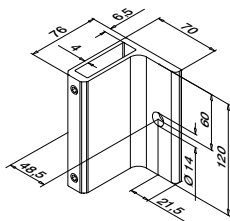

MOD 9028

Aluminium Brut		
169028-120-00-00	457 - 463	1
Aluminium Effet argenté mat		
OUTDOOR		
169028-120-00-08	457 - 463	1
Aluminium Thermolaqué RAL 7016, texture		
OUTDOOR		
169028-120-00-33	457 - 463	1



Angle sortant



Gauche / droite

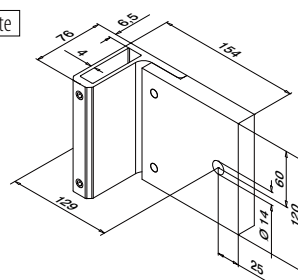

MOD 9028

Aluminium Brut		
169028-120-90-00	457 - 463	1
Aluminium Effet argenté mat		
OUTDOOR		
169028-120-90-08	457 - 463	1
Aluminium Thermolaqué RAL 7016, texture		
OUTDOOR		
169028-120-90-33	457 - 463	1



Embout pour poteaux, montage latéral



Sol

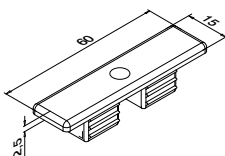

MOD 5743 - EASY HIT®

Plastique Aluminium blanc RAL 9006	
OUTDOOR	
155743-36	2
Plastique Gris anthracite RAL 7016	
OUTDOOR	
155743-33	2



Q-INFO MOD 9028



Q-INFO Plastique



Q-INFO Aluminium



Q-INFO MOD 5743 / 9028

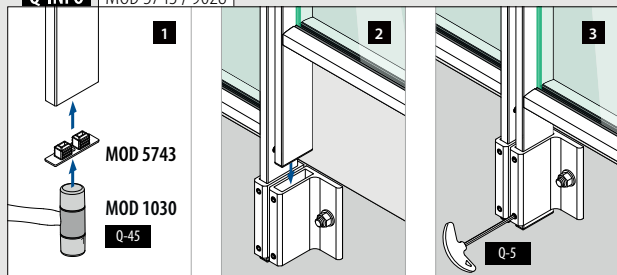

Q-INFO MOD 9028-120-00 / 9028-120-90

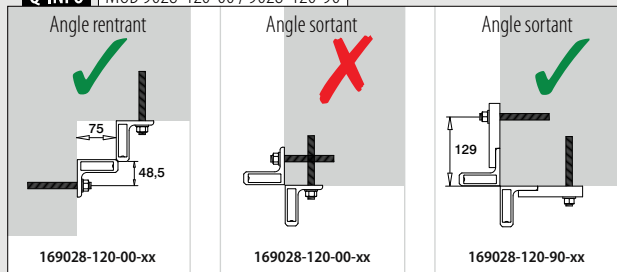

Q-INFO MOD 9028-120-90

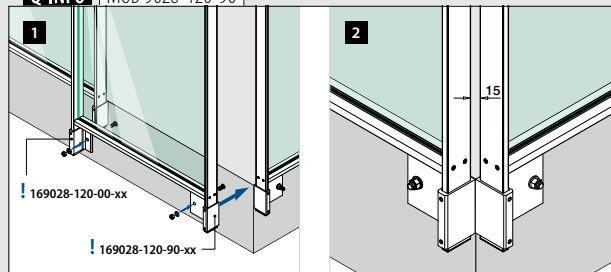

Rail pour verre

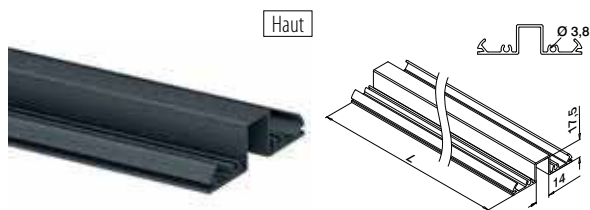

MOD 5951

Aluminium	Brut		
165951-050-00	QS-267	471	L = 5 m
Aluminium	Brossé, anodisé		
OUTDOOR			
165951-050-18	QS-267	471	L = 5 m
Aluminium	Thermolaqué RAL 7016, texture		
OUTDOOR			
165951-050-33	QS-267	471	L = 5 m
Aluminium	Black Line		
OUTDOOR			
NEW	165951-050-82	QS-267	471 L = 5 m

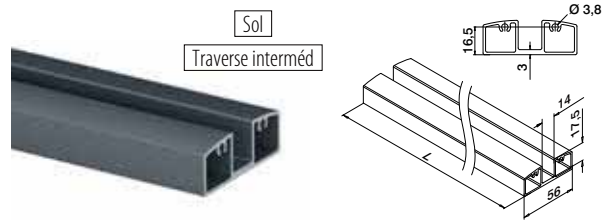

MOD 5952

Aluminium	Brut		
165952-050-00	QS-267	471	L = 5 m
Aluminium	Brossé, anodisé		
OUTDOOR			
165952-050-18	QS-267	471	L = 5 m
Aluminium	Thermolaqué RAL 7016, texture		
OUTDOOR			
165952-050-33	QS-267	471	L = 5 m
Aluminium	Black Line		
OUTDOOR			
NEW	165952-050-82	QS-267	471 L = 5 m



Glass Wing caoutchoucs pour verre

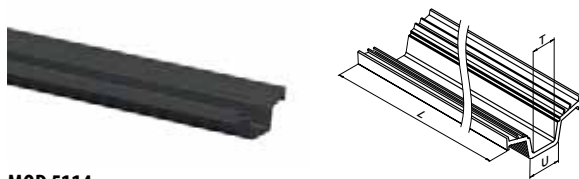

MOD 5114

Accessoires			
Pour verre monolithique	U	T	
205114-050-08	14	8	L = 5 m
205114-050-10	14	10	L = 5 m
Pour verre feuilleté			
205114-050-08	14	8,76	L = 5 m
205114-050-10	14	9,52 - 10,76	L = 5 m

International Design Modèle Protection

Adaptateurs pour rail de verre

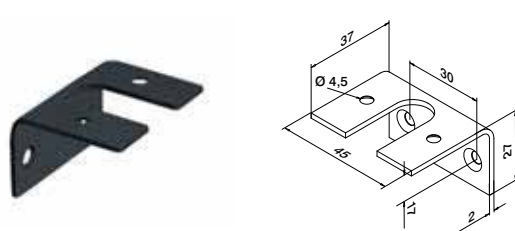

MOD 5960

Aluminium	Brut		
165960-00	QS-268	471	4
Aluminium	Brossé, anodisé		
OUTDOOR			
165960-18	QS-268	471	4
Aluminium	Thermolaqué RAL 7016, texture		
OUTDOOR			
165960-33	QS-268	471	4
Aluminium	Black Line		
OUTDOOR			
NEW	165960-82	QS-268	471 4



Q-INFO | MOD 5952

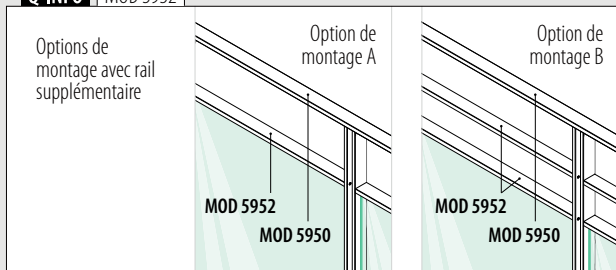

Q-INFO | MOD 5951 / 5952 / 5960

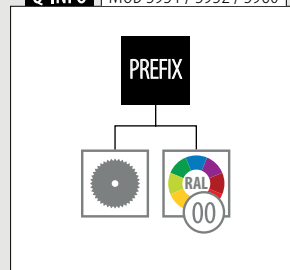

Q-INFO | MOD 5960



Profil main courante

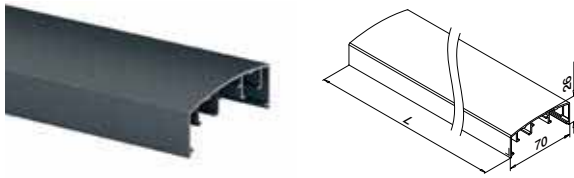

MOD 5950

Aluminium	Brut	
165950-050-00		L = 5 m
Aluminium	Brossé, anodisé	
OUTDOOR		
165950-050-18		L = 5 m
Aluminium	Thermolaqué RAL 7016, texture	
OUTDOOR		
165950-050-33		L = 5 m
Aluminium	Black Line	
OUTDOOR		
NEW	165950-050-82	L = 5 m

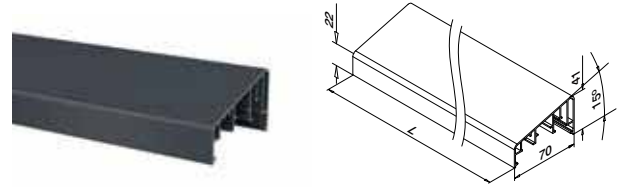

MOD 5953

Aluminium	Brut	
165953-050-00		L = 5 m
Aluminium	Brossé, anodisé	
OUTDOOR		
165953-050-18		L = 5 m
Aluminium	Thermolaqué RAL 7016, texture	
OUTDOOR		
165953-050-33		L = 5 m
Aluminium	Black Line	
OUTDOOR		
NEW	165953-050-82	L = 5 m



Q-INFO Aluminium

Brut	Brossé, anodisé	Thermolaqué Gris anthracite, mat, texture	Thermolaqué Noir, mat, texture

Q-INFO

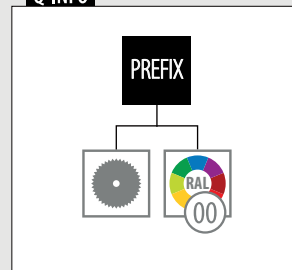

Q-INFO

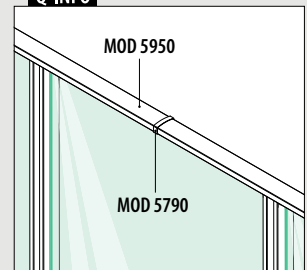

Raccord pour jointure



MOD 5790

Plastique	Aluminium blanc RAL 9006
OUTDOOR	
155790-36	2
Plastique	Gris anthracite RAL 7016
OUTDOOR	
155790-33	2
Plastique	Noir RAL 9005
OUTDOOR	
NEW 155790-80	2

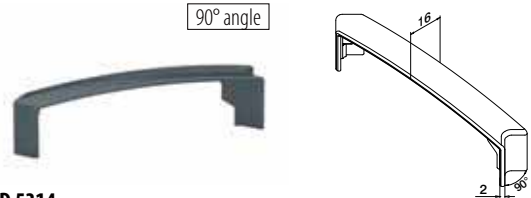

MOD 5314

Plastique	Aluminium blanc RAL 9006
OUTDOOR	
155314-36	2
Plastique	Gris anthracite RAL 7016
OUTDOOR	
155314-33	2
Plastique	Noir RAL 9005
OUTDOOR	
NEW 155314-80	2

Raccords

Orientables

2x par angle / connexion

0 - 90°

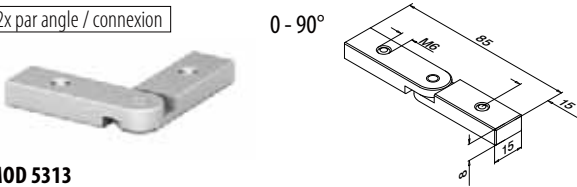

MOD 5313

Aluminium	Brut
165313	2



Q-INFO **Plastique**



Aluminium blanc, brillant de soie, uni

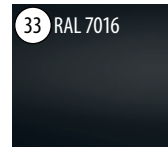

Gris anthracite, mat, uni



Noir, brillant de soie, texture

Q-INFO MOD 5313 / 5314

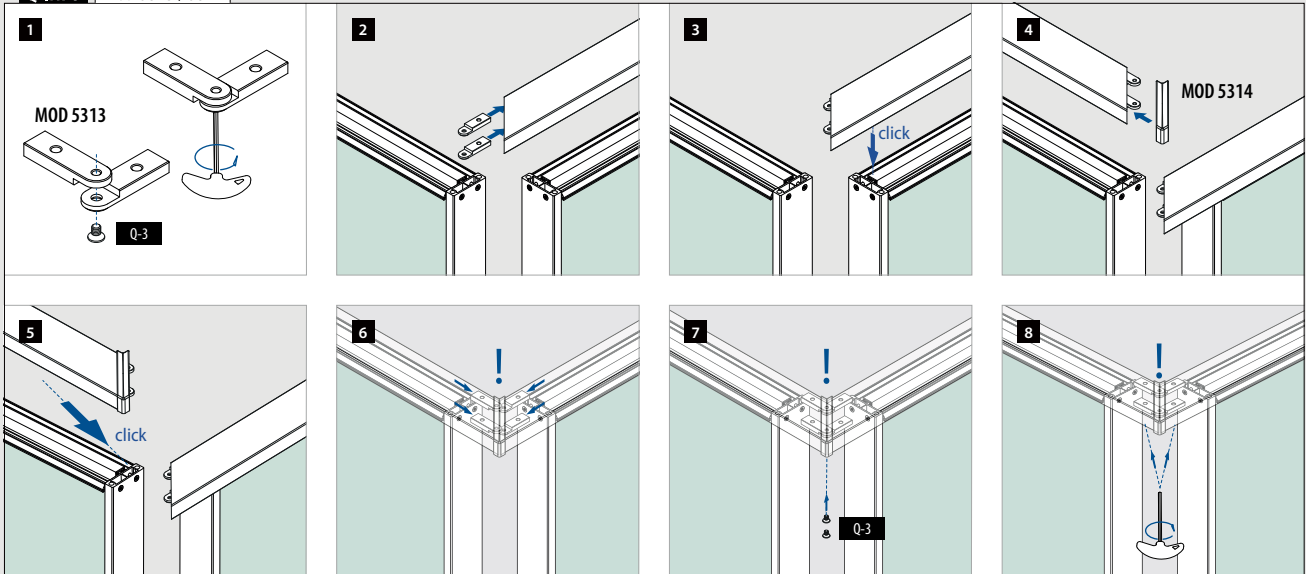

Q-INFO MOD 5313 / 5790

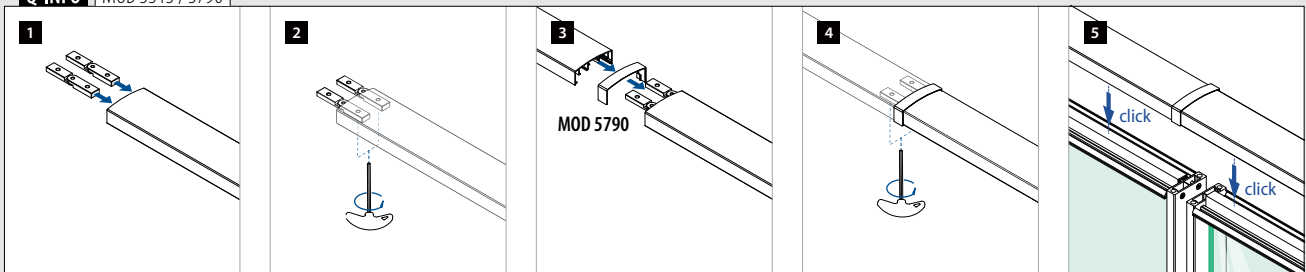

Embout pour profil main courante

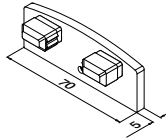

MOD 5742 - EASY HIT®

Aluminium	Brut	
165742-00		2
Aluminium	Brossé, anodisé	
OUTDOOR		
165742-18		2
Aluminium	Thermolaqué RAL 7016, texture	
OUTDOOR		
165742-33		2
Aluminium	Black Line	
OUTDOOR		
NEW	165742-82	2



Embases murales pour profil

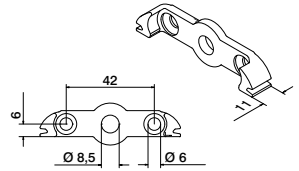

MOD 5505

Aluminium	Brut			
165505	QS-267 ■ 471 / QS-87 ■ 470			2



Q-INFO MOD 5742

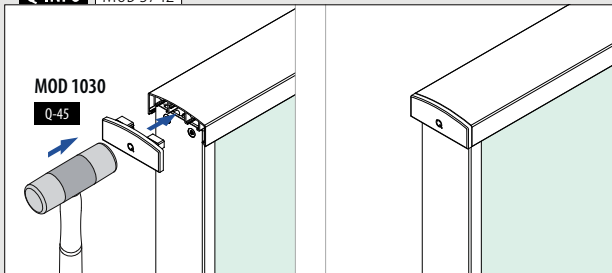

Q-INFO MOD 5505

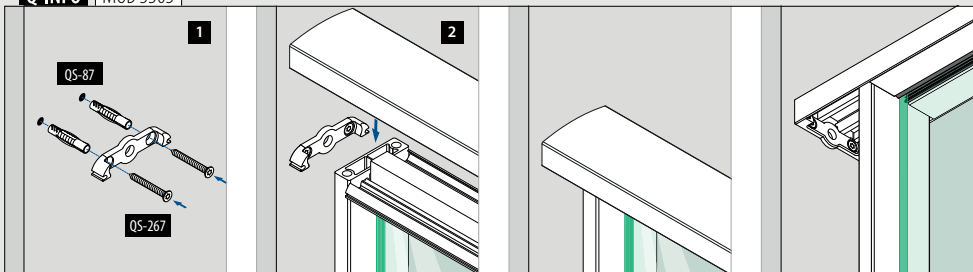

Q-INFO MOD 5742

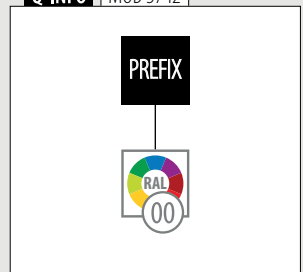

Embout pour profil main courante

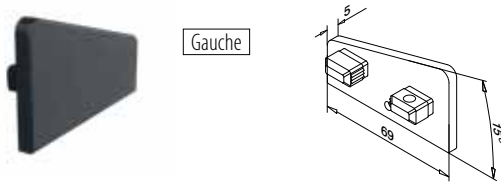

Gauche

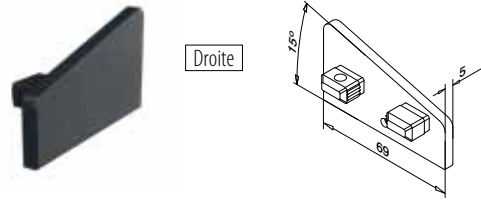

Droite

MOD 5744

Aluminium	Brut	
165744-01-00		2
Aluminium	Brossé, anodisé	
OUTDOOR		
165744-01-18		2
Aluminium	Thermolaqué RAL 7016, texture	
OUTDOOR		
165744-01-33		2
Aluminium	Black Line	
OUTDOOR		
165744-01-82		2

NEW

MOD 5744

Aluminium	Brut	
165744-02-00		2
Aluminium	Brossé, anodisé	
OUTDOOR		
165744-02-18		2
Aluminium	Thermolaqué RAL 7016, texture	
OUTDOOR		
165744-02-33		2
Aluminium	Black Line	
OUTDOOR		
165744-02-82		2

NEW

Q-INFO Aluminium

00	18	33 RAL 7016	82 RAL 9005
Brut	Brossé, anodisé	Thermolaqué	Thermolaqué
		Gris anthracite, mat, texture	Noir, mat, texture

Q-INFO

PREFIX
RAL
00



Remplissage de rambarde à barreaux

Transformez votre système de garde-corps Easy Alu en un balcon à la française évoquant une rambarde à barreaux. Disponible sur demande.

Remplissage en panneaux de tôle

Donnez à votre système de garde-corps une apparence moderne et robuste en ajoutant des remplissages en panneaux de tôle. Disponible sur demande.

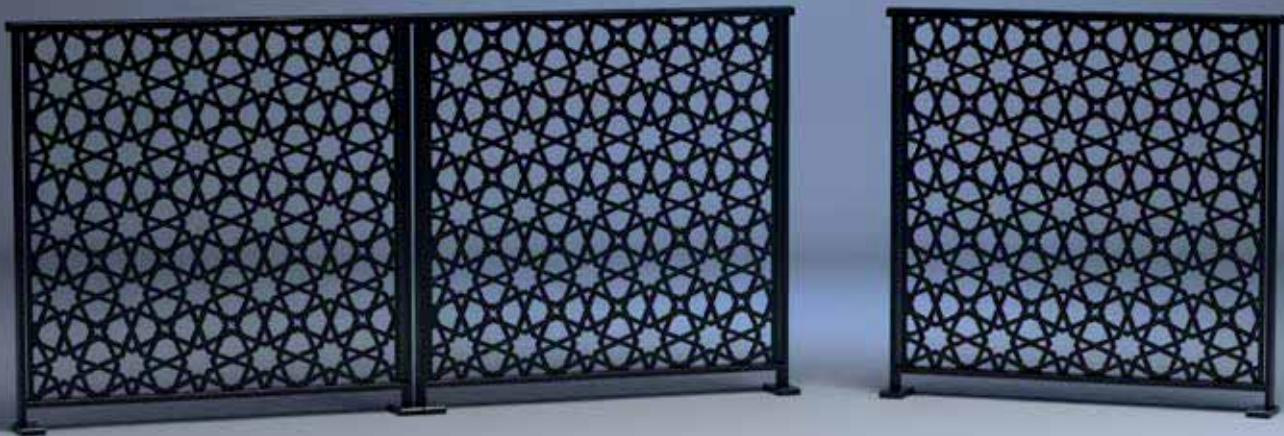

VOS OPTIONS DE COMMANDE

Option

1 MODULES PRETS A INSTALLER

- Q-RAILING: ■ Effectue tous les travaux de coupe et de perçage nécessaires
- Vous fournit exactement la finition que vous souhaitez (brossé anodisé, brut de laminage ou thermolaqué dans toutes les couleurs RAL)
 - Préassemble tous les éléments
 - Vous envoie les modules achevés parfaitement conformes à vos spécifications

- VOUS: ■ Positionnez les modules sur le chantier
- Fixez les modules au sol
 - Clipsez la main-courante sur le dessus



Option

2 COMPOSANTS INDIVIDUELS PREFABRIQUES

- Q-RAILING: ■ Effectue tous les travaux de coupe et de perçage nécessaires
- Se charge au besoin du thermolaquage
 - Vous envoie les composants parfaitement conformes à vos spécifications

- VOUS: ■ Préassemblez les modules à partir des composants
- Positionnez les modules sur le chantier
 - Fixez les modules au sol
 - Clipsez la main-courante sur le dessus



Option

3 COMPOSANTS INDIVIDUELS STANDARDS

- Q-RAILING: ■ Vous envoie les composants standards

- VOUS: ■ Vous vous chargez de la coupe, du perçage et, au besoin, du thermolaquage
- Préassemblez les modules à partir des composants
 - Positionnez les modules sur le chantier
 - Fixez les modules au sol
 - Clipsez la main-courante sur le dessus





Retrouvez toutes les informations sur Square Line® 40x10 en ligne :



<https://q-ne.ws/SquareLine41-23>

SQUARE LINE®

40x10

Mains-courantes

Supports de main-courante

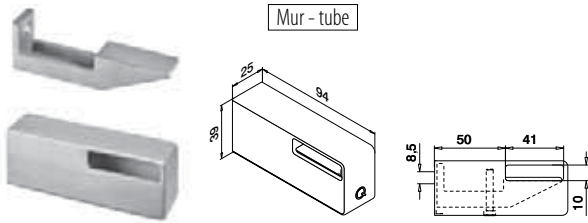

MOD 4134

304	Inox brossé			
INDOOR	Pour tube			
134134-041-12	40 x 10 x 1,5	QS-35	467 / QS-3	471
				2
304	Black Line			
INDOOR				
NEW	134134-041-82	40 x 10 x 1,5	QS-35	467 / QS-3
				471
				2
316	Inox brossé			
OUTDOOR				
SELL OUT	144134-041-12	40 x 10 x 1,5	QS-34	467 / QS-4
				471
				2



International Design
Modèle Protection

Mains-courantes

Tubes

Q-TUBE

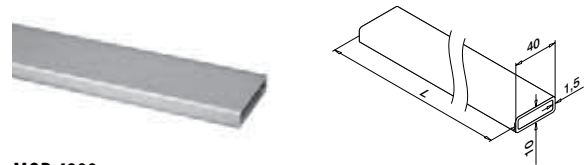

MOD 4900

304	Inox brossé		
INDOOR			
134900-041-25-12	40 x 10 x 1,5		L = 2,5 m
134900-041-50-12	40 x 10 x 1,5		L = 5 m
304	Black Line		
INDOOR			
NEW	134900-041-50-82	40 x 10 x 1,5	L = 5 m
316	Inox brossé		
OUTDOOR			
SELL OUT	144900-041-25-12	40 x 10 x 1,5	L = 2,5 m
SELL OUT	144900-041-50-12	40 x 10 x 1,5	L = 5 m



Q-INFO | MOD 4134 / 4900

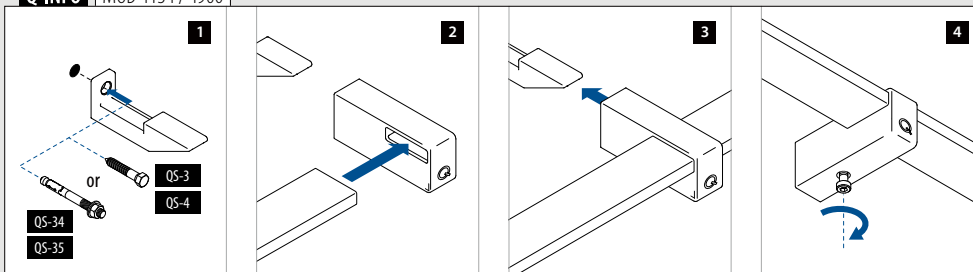

Q-INFO | MOD 4900

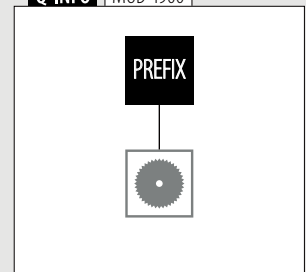

Raccords

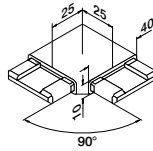
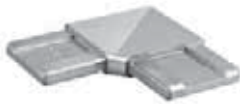

MOD 4301

304 Inox brossé

INDOOR Pour tube

134301-041-12 40 x 10 x 1,5 2

304 Black Line

INDOOR

NEW 134301-041-82 40 x 10 x 1,5 2

316 Inox brossé

OUTDOOR

SELL OUT 144301-041-12 40 x 10 x 1,5 2

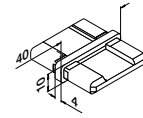

MOD 4790

304 Inox brossé

INDOOR Pour tube

134790-041-12 40 x 10 x 1,5 2

304 Black Line

INDOOR

NEW 134790-041-82 40 x 10 x 1,5 2

316 Inox brossé

OUTDOOR

SELL OUT 144790-041-12 40 x 10 x 1,5 2



Raccords

Orientables

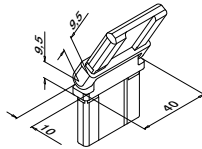
-70°
+70°

MOD 4312

304 Inox brossé

INDOOR Pour tube

134312-041-12 40 x 10 x 1,5 2

316 Inox brossé

OUTDOOR

SELL OUT 144312-041-12 40 x 10 x 1,5 2



Embout

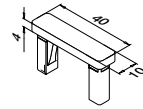

MOD 4732

304 Inox brossé

INDOOR Pour tube

134732-041-12 40 x 10 x 1,5 2

304 Black Line

INDOOR

NEW 134732-041-82 40 x 10 x 1,5 2

316 Inox brossé

OUTDOOR

SELL OUT 144732-041-12 40 x 10 x 1,5 2



Q-INFO 304

12



Inox brossé

82

Noir, mat,
texture

Thermolaqué



Seulement jusqu'à épuisement des stocks.



Retrouvez toutes les informations sur Square Line® 40x20 en ligne :



<https://q-ne.ws/SquareLine42-23>

SQUARE LINE® 40x20

MAIN-COURANTE
ÉPURÉE ET ÉLÉGANTE

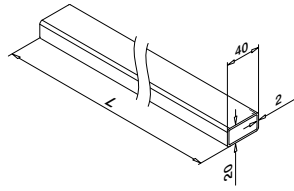

MOD 4900

304

Inox brossé

INDOOR



134900-020-50-12 40 x 20 x 2,0

L = 5 m

316

Inox brossé

OUTDOOR

NEW 144900-020-50-12 40 x 20 x 2,0

L = 5 m

PREFIX

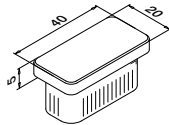

MOD 5728 - EASY HIT®

304

Inox brossé

INDOOR

Pour tube



135728-020-12 40 x 20 x 2,0

2

316

Inox brossé

OUTDOOR

NEW 145728-020-12 40 x 20 x 2,0

2

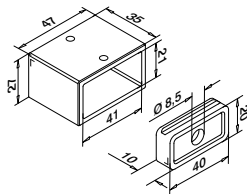

MOD 4504

304

Inox brossé

INDOOR

Pour tube



134504-020-12 40 x 20 x 2,0 QS-55 470 / QS-26 472 2

316

Inox brossé

OUTDOOR

144504-020-12 40 x 20 x 2,0 QS-55 470 / QS-27 472 2

NEW

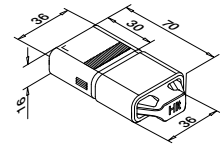

MOD 5794 - EASY HIT®

316

Brut

OUTDOOR

Pour tube



145794-020 40 x 20 x 2,0

2

NEW

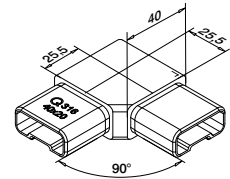

MOD 4301

304

Inox brossé

INDOOR

Pour tube



134301-020-12 40 x 20 x 2,0

2

316

Inox brossé

OUTDOOR

144301-020-12 40 x 20 x 2,0

2

NEW



0-70°

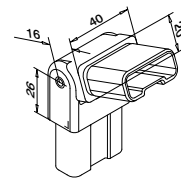

MOD 4312

304

Inox brossé

INDOOR

Pour tube



134312-020-12 40 x 20 x 2,0

2

316

Inox brossé

OUTDOOR

144312-020-12 40 x 20 x 2,0

2

NEW



Q-INFO MOD 4900

PREFIX



Mains-courantes

Supports de main-courante

Orientables

Montage sur les poteaux

Pour tube plat

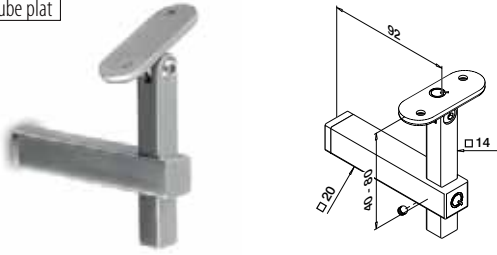

MOD 4133

304 Inox brossé

INDOOR

SELL OUT	134133-000-12	QS-55	470 / QS-21	472 / QS-12	472	2
----------	---------------	-------	-------------	-------------	-----	---



Mains-courantes

Supports de main-courante

Orientables

Fixation sur le verre

Pour tube plat

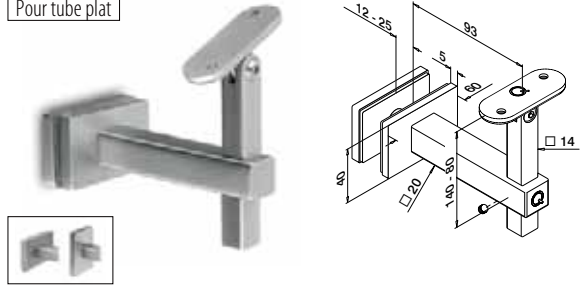

MOD 4155

304 Inox brossé

INDOOR

SELL OUT	134155-000-12	QS-12	472	2
----------	---------------	-------	-----	---



Mains-courantes

Supports de main-courante

Orientables

Montage latéral

Pour tube plat

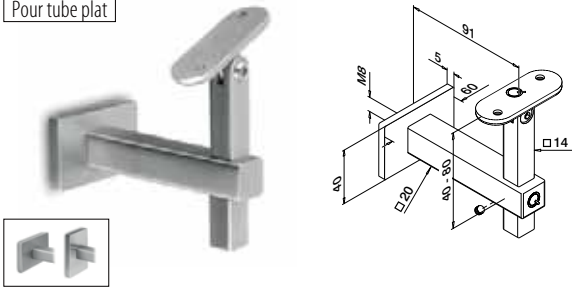

MOD 4145

304 Inox brossé

INDOOR

SELL OUT	134145-000-12	QS-1	471 / QS-12	472	2
----------	---------------	------	-------------	-----	---

316 Inox brossé

OUTDOOR

SELL OUT	144145-000-12	QS-2	471 / QS-13	472	2
----------	---------------	------	-------------	-----	---



Mains-courantes

Supports de main-courante

Montage latéral

Pour tube plat

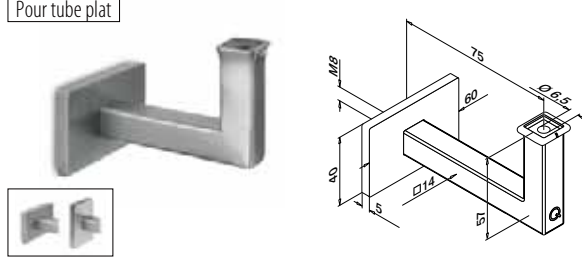

MOD 4121

304 Inox brossé

INDOOR

SELL OUT	134121-000-12	QS-1	471 / QS-54	472	2
----------	---------------	------	-------------	-----	---

316 Inox brossé

OUTDOOR

SELL OUT	144121-000-12	QS-2	471 / QS-70	472	2
----------	---------------	------	-------------	-----	---

NEW



Q-INFO MOD 4155

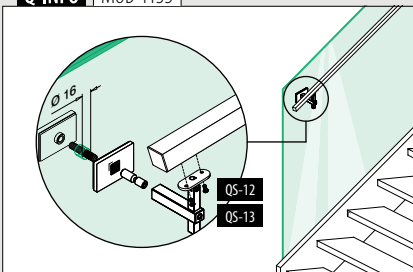

Q-INFO

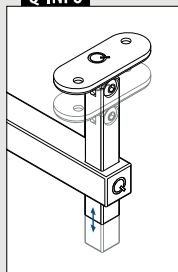

Q-INFO MOD 4133 / 4155 / 4145

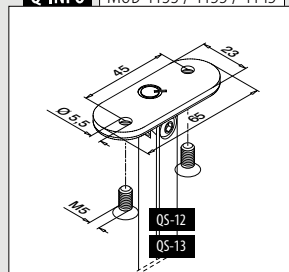

Pour tube plat

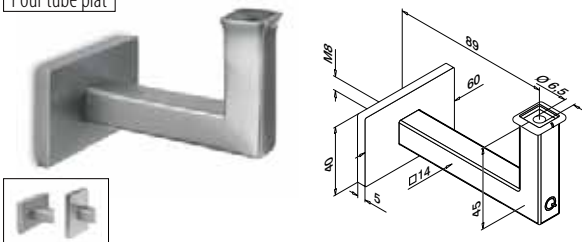

MOD 4111

304 Inox brossé

INDOOR	
134111-000-12	QS-1 471 / QS-54 472
	2

316 Inox brossé

OUTDOOR	
NEW 144111-000-12	QS-2 471 / QS-70 472
	2



Pour tube plat

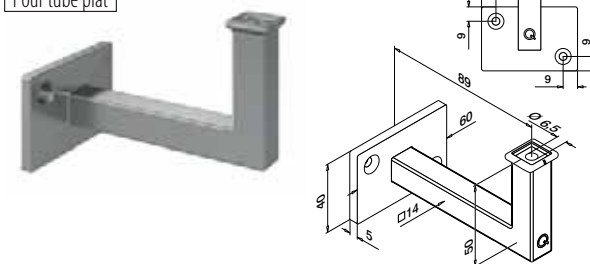

MOD 4112

304 Inox brossé

INDOOR	
134112-000-12	QS-5 471 / QS-54 472
	2

316 Inox brossé

OUTDOOR	
NEW 144112-000-12	QS-6 471 / QS-70 472
	2



Q-INFO MOD 4111

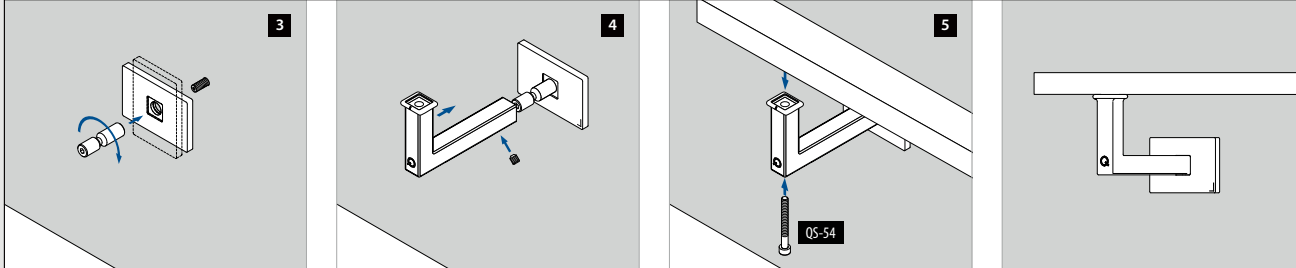

Q-INFO MOD 4111 / 4112

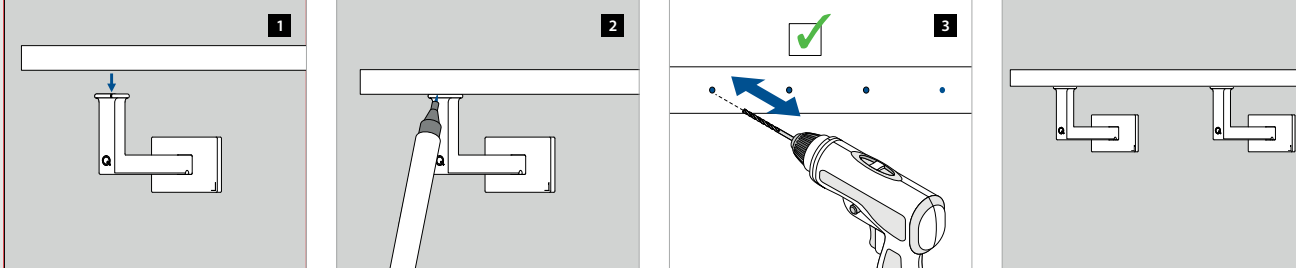



Conçu pour : Utilisation faible
Utilisation : Intérieur et extérieur
Variantes : Montage au sol, latéral et engravé
Applications : Balcons, galeries, passerelles, cloisons, escaliers, pare-vents et protection de fenêtres
Matériau : Acier inoxydable 304 et 316 (brossé ou thermolaqué en RAL 9005 noir)

Retrouvez toutes les informations sur Square Line® 40x40 en ligne :



<https://q-ne.ws/SquareLine44-23>

SQUARE LINE® 40x40



Un esprit résolument contemporain

Square Line® 40x40 prouve que simplicité et design peuvent aller de pair. Ses lignes épurées et sa finition en inox confèrent aux garde-corps et aux rampes d'escalier une esthétique élégante d'une grande sobriété. Mais si vous préférez les formes arrondies, ce n'est pas un problème. Square Line s'adapte facilement à vos envies : pourquoi ne pas l'associer à certains éléments d'autres systèmes de garde-corps Q-railing ?

Tests/calculs/certificats internationaux:



- 1 Le système comprend une vaste sélection de remplissages, dont du verre, des barres, des filets et des câbles.
- 2 Choisissez parmi différentes options de LED pour les mains-courantes.
- 3 Créez un look contemporain grâce à son design industriel.



REPLISSAGES SQUARE LINE® 40x40

Verre

- Encadrement pour verre
- Pincés à verre
- Adaptateurs à verre
- Supports de verre



■ 386 - 390

Barre et tube

- Remplissages horizontaux
- Remplissages verticaux



■ 391 - 403

Câble

- Fast Fix Ø 3,2 mm
- Fast Fix Ø 4,0 mm
- Easy Fix Ø 3,2 mm
- Easy Fix Ø 6,0 mm

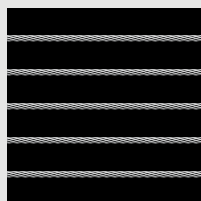

■ 404 - 411

Filet

- Easy Q-web

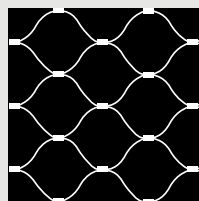

■ 412 - 415

Panneau de tôle

- Pincés à tôle

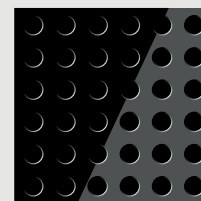

■ 416 - 419

Poteaux

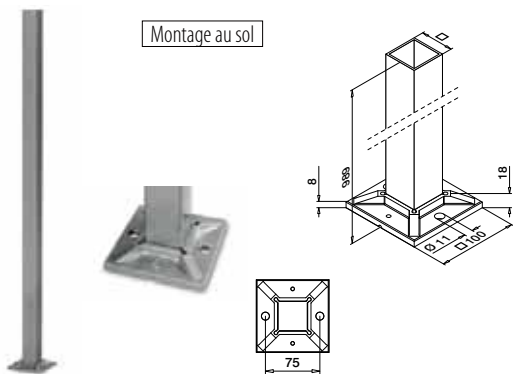

MOD 4921

304	Inox brossé			
INDOOR				
134921-040-12	40 x 40 x 2,0	Q5-59	467	1
316	Inox brossé			
OUTDOOR				
144921-040-12	40 x 40 x 2,0	Q5-58	467	1



Tubes prédecoupés

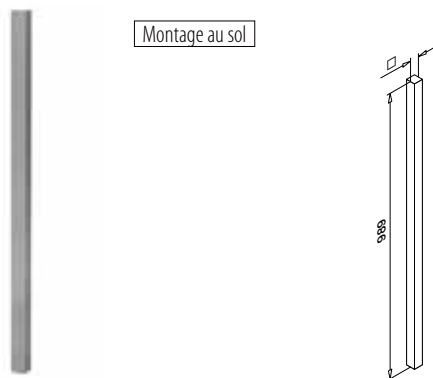

MOD 4901

304	Inox brossé			
INDOOR				
134901-040-12	40 x 40 x 2,0			1

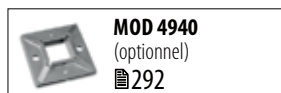

Cache embases



MOD 4511

304	Inox brossé			
INDOOR		H		
134511-040-12	108	25		2
316	Inox brossé			
OUTDOOR				
144511-040-12	108	25		2

Embases-manchons

Pour marches flottantes

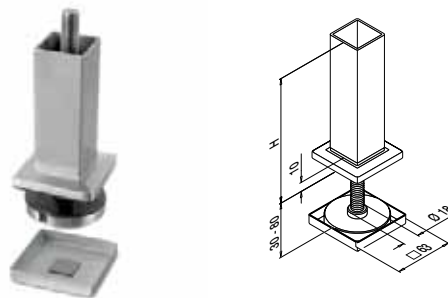

MOD 4546

304	Inox brossé			
INDOOR	Pour tube		H	
134546-040	40 x 40 x 2,0		100	1



Q-INFO | MOD 4921 / 4901 / 4546

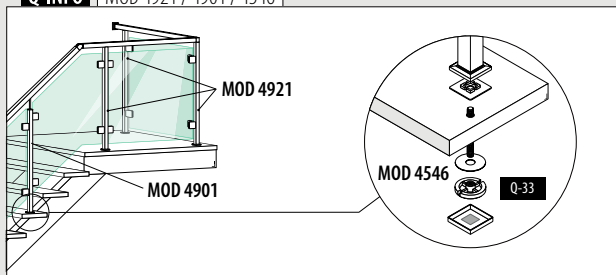

Q-INFO | MOD 4921 / 4901

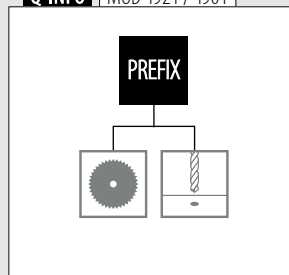

Q-INFO | MOD 4546 / 4901

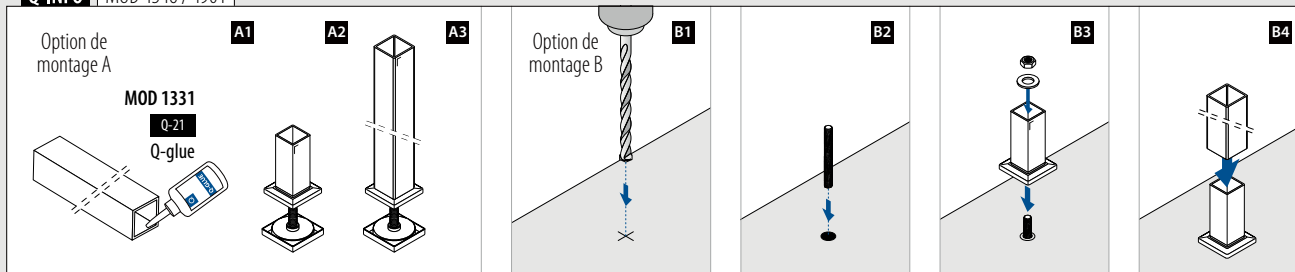

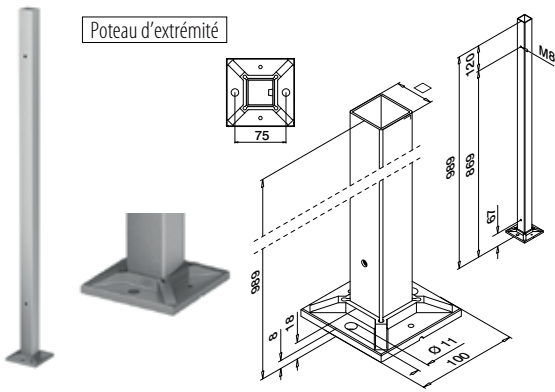

MOD 4972

304	Inox brossé			
INDOOR				
134972-040-01-12	40 x 40 x 2,0	QS-59	467	1
304	Black Line			
INDOOR				
NEW 134972-040-01-82	40 x 40 x 2,0	QS-59	467	1
316	Inox brossé			
OUTDOOR				
144972-040-01-12	40 x 40 x 2,0	QS-58	467	1

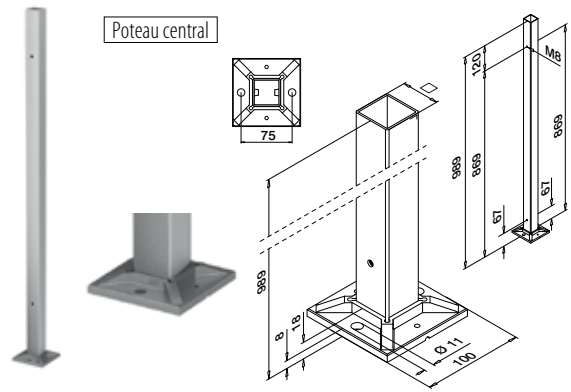

MOD 4972

304	Inox brossé			
INDOOR				
134972-040-02-12	40 x 40 x 2,0	QS-59	467	1
316	Inox brossé			
OUTDOOR				
144972-040-02-12	40 x 40 x 2,0	QS-58	467	1

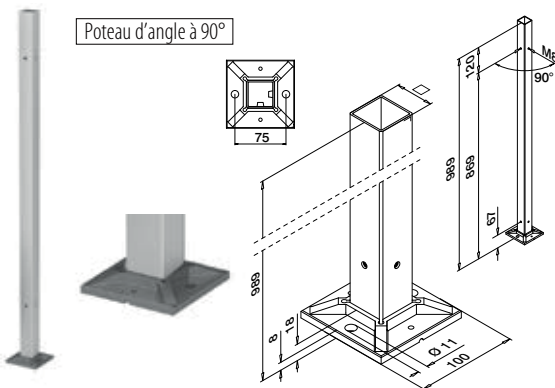

MOD 4972

304	Inox brossé			
INDOOR				
134972-040-90-12	40 x 40 x 2,0	QS-59	467	1
316	Inox brossé			
OUTDOOR				
144972-040-90-12	40 x 40 x 2,0	QS-58	467	1



Cache embases



MOD 4511

304	Inox brossé			
INDOOR		H		
134511-040-12	108	25		2
304	Black Line			
INDOOR				
NEW 134511-040-82	108	25		2
316	Inox brossé			
OUTDOOR				
144511-040-12	108	25		2

SYSTEMES DE GARDE-CORPS À POTEAUX

SQUARE LINE® 40X40

Q-INFO MOD 4972



MOD 4200
434



399

Remplissages de barres et tubes - rectangulaire

Q-INFO

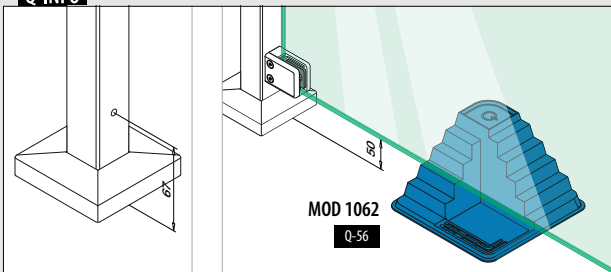

MOD 1062
Q-56

Q-INFO MOD 4972

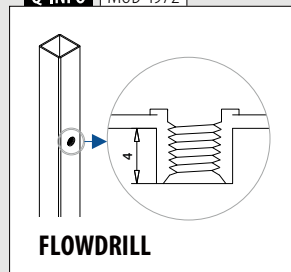

FLOWDRILL

Q-INFO 304

12

82 RAL 9005

Inox brossé

Thermolaqué

Noir, mat, texture

Poteaux

Embases-manchons

Angle ajustable

Pour collage

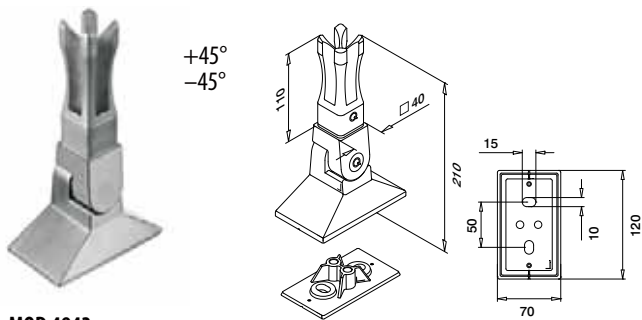

MOD 4943

304 Inox brossé

INDOOR	Pour tube □		
134943-040-12	40 x 40 x 2,0	QS-63	464 1

316 Inox brossé

OUTDOOR			
144943-040-12	40 x 40 x 2,0	QS-62	464 1



International Design Modèle Protection

Poteaux

Embases-manchons

Pour collage

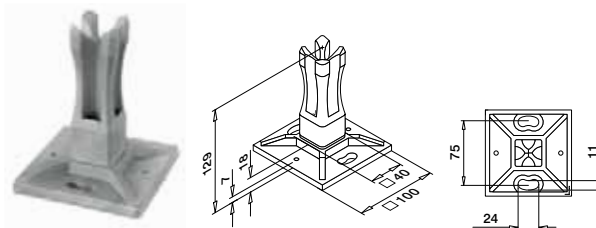

MOD 4942

304 Inox brossé

INDOOR	Pour tube □		
134942-040	40 x 40 x 2,0	QS-59	467 2

316 Inox brossé

OUTDOOR			
144942-040	40 x 40 x 2,0	QS-58	467 2



International Design Modèle Protection

Poteaux

Cache embases



MOD 4511

304 Inox brossé

INDOOR	□	H	
134511-040-12	108	25	2

316 Inox brossé

OUTDOOR			
144511-040-12	108	25	2

Poteaux

Embases pour poteaux

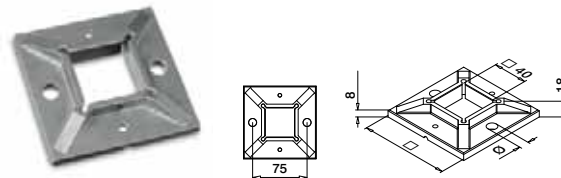

MOD 4940

304 Brut

INDOOR	□	∅		
134940-040	100	11	QS-59	467 2

316 Brut

OUTDOOR				
144940-040	100	11	QS-58	467 2

Q-INFO MOD 4942 / 4901 / 4511

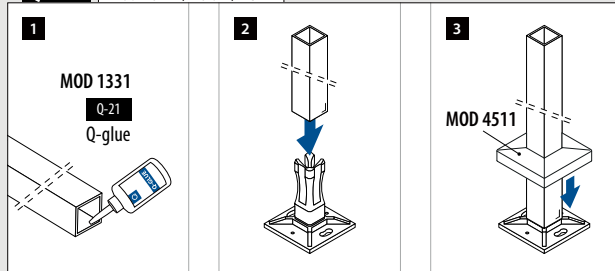

SELL OUT Seulement jusqu'à épuisement des stocks.

Q-INFO MOD 4943

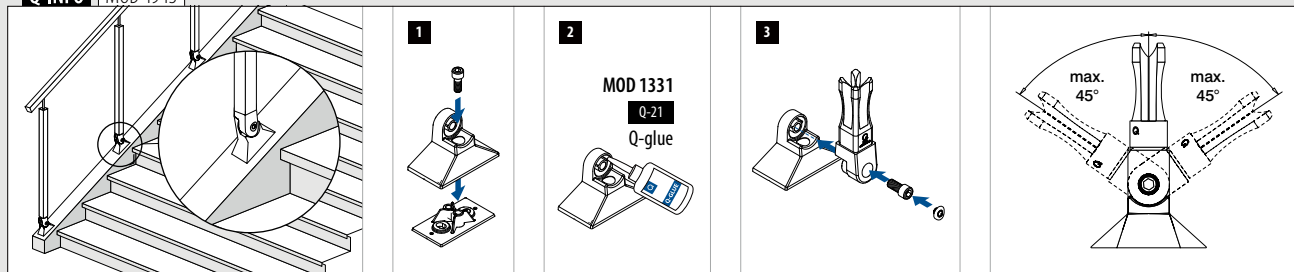

Support mural pour poteau

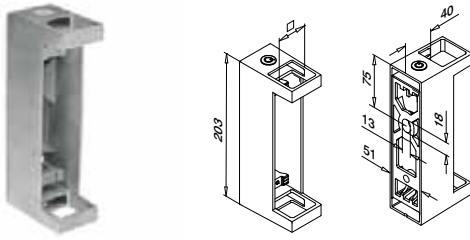

MOD 4558

304 Inox brossé			
INDOOR	<input type="checkbox"/>		
134558-040-12	40 x 40	QS-63 464	1
316 Inox brossé			
OUTDOOR	<input type="checkbox"/>		
144558-040-12	40 x 40	QS-62 464	1

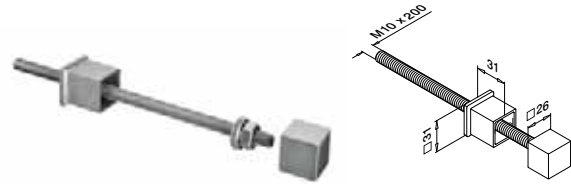

MOD 0554

304 Inox brossé			
INDOOR	<input type="checkbox"/>	Pour tube <input type="checkbox"/>	
SELL OUT 130554-040-12	40 x 40		2
316 Inox brossé			
OUTDOOR	<input type="checkbox"/>	<input type="checkbox"/>	
140554-040-12	40 x 40		2

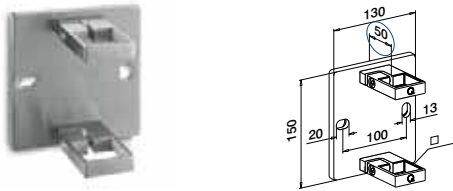

MOD 4551

304 Inox brossé			
INDOOR	<input type="checkbox"/>		
134551-040-12	40 x 40	QS-33 464	1

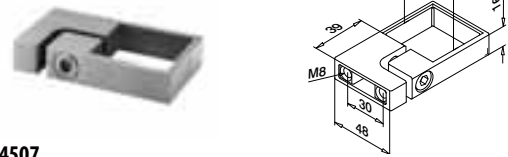

MOD 4507

304 Inox brossé			
INDOOR	<input type="checkbox"/>	<input type="checkbox"/>	
134507-040-12	40 x 40		2
316 Inox brossé			
OUTDOOR	<input type="checkbox"/>	<input type="checkbox"/>	
NEW 144507-040-12	40 x 40		2

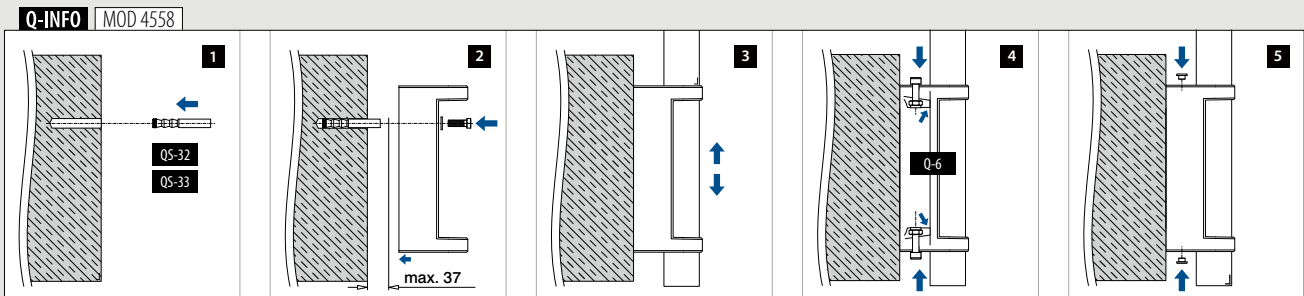
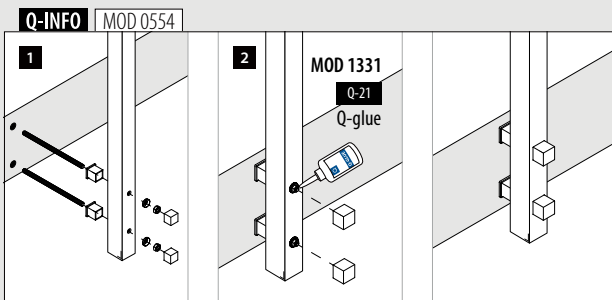

Pour tube plat

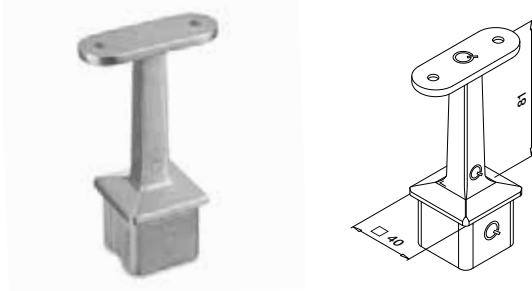

MOD 4710

304		Inox brossé	
INDOOR	Pour tube □		
134710-000-00-12	40 x 40 x 2,0	QS-12 472	2
304		Black Line	
INDOOR			
134710-000-00-82	40 x 40 x 2,0	QS-12 472	2
316		Inox brossé	
OUTDOOR			
144710-000-00-12	40 x 40 x 2,0	QS-13 472	2



Pour tube plat à tube rond

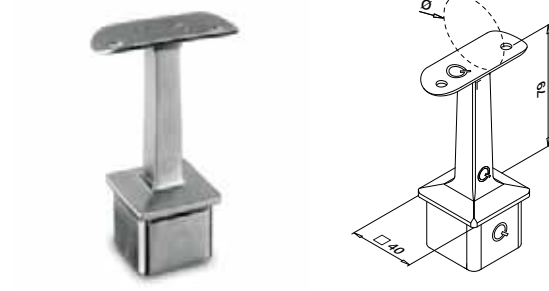

MOD 4710

304		Inox brossé	
INDOOR	∅	Pour tube □	
134710-042-00-12	42,4	40 x 40 x 2,0	QS-10 472 2
134710-048-00-12	48,3	40 x 40 x 2,0	QS-10 472 2
316		Inox brossé	
OUTDOOR			
144710-042-00-12	42,4	40 x 40 x 2,0	QS-11 472 2
144710-048-00-12	48,3	40 x 40 x 2,0	QS-11 472 2



Pour tube plat

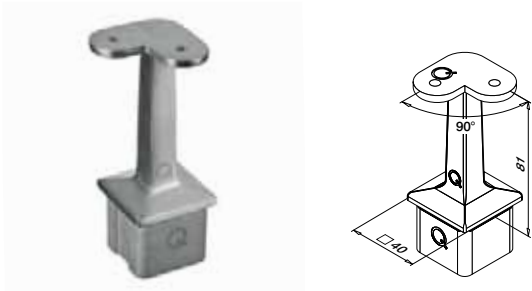

MOD 4710

304		Inox brossé	
INDOOR	Pour tube □		
134710-000-90-12	40 x 40 x 2,0	QS-12 472	2
316		Inox brossé	
OUTDOOR			
144710-000-90-12	40 x 40 x 2,0	QS-13 472	2



Pour tube plat à tube rond

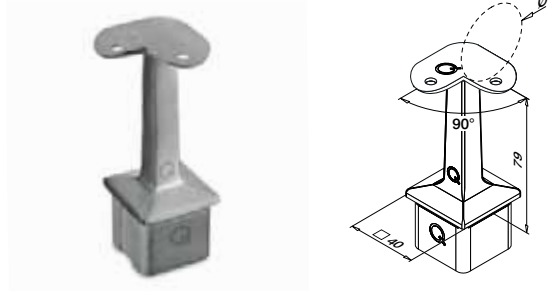

MOD 4710

304		Inox brossé	
INDOOR	∅	Pour tube □	
134710-042-90-12	42,4	40 x 40 x 2,0	QS-10 472 2
316		Inox brossé	
OUTDOOR			
144710-042-90-12	42,4	40 x 40 x 2,0	QS-11 472 2



Q-INFO | MOD 4710-000-00 / 4710-04x-00

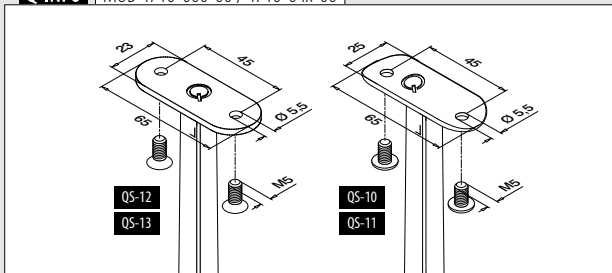

Q-INFO | 304



Q-INFO | MOD 4710-000-90 / 4710-042-90

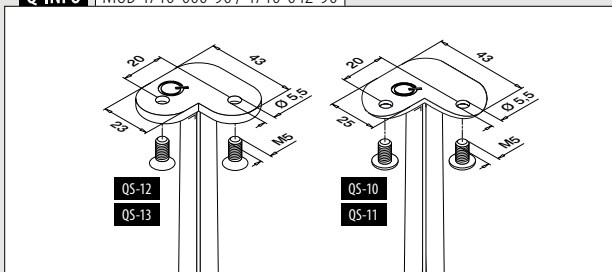

Q-INFO | MOD 4710-000-90

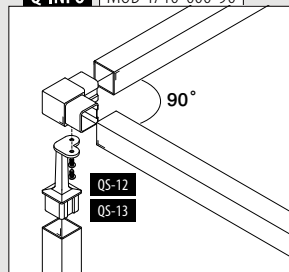

Q-INFO | MOD 4710-042-90

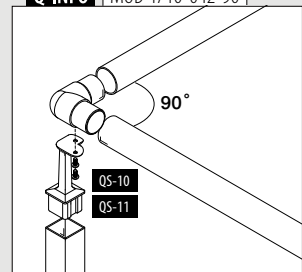

Pour tube plat

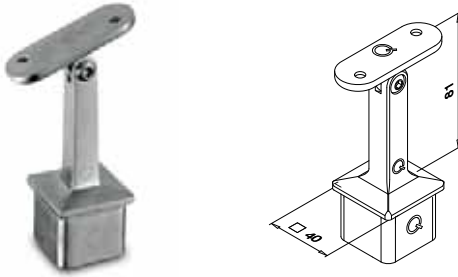
**MOD 4718**

304 Inox brossé				
INDOOR	Pour tube □			
134718-000-12	40 x 40 x 2,0	QS-12	472	2
316 Inox brossé				
OUTDOOR				
144718-000-12	40 x 40 x 2,0	QS-13	472	2

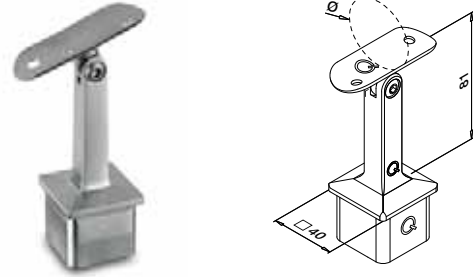

Pour tube plat à tube rond

**MOD 4718**

304 Inox brossé				
INDOOR	Ø	Pour tube □		
134718-042-12	42,4	40 x 40 x 2,0	QS-10	472 2
134718-048-12	48,3	40 x 40 x 2,0	QS-10	472 2
316 Inox brossé				
OUTDOOR				
144718-042-12	42,4	40 x 40 x 2,0	QS-11	472 2

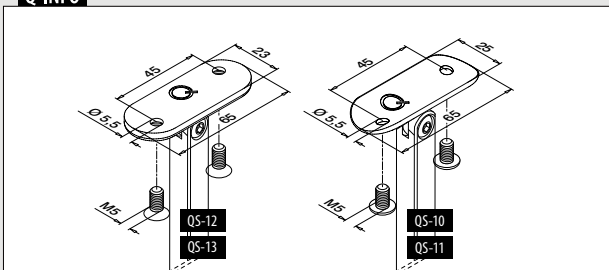
**Q-INFO**

Seulement jusqu'à épuisement des stocks.

Pour tube plat

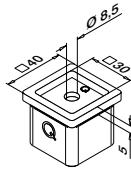

MOD 4727

304	Inox brossé		
INDOOR	Pour tube <input type="checkbox"/>		
134727-12	40 x 40 x 2,0	QS-26	2
316	Inox brossé		
OUTDOOR			
NEW 144727-12	40 x 40 x 2,0	QS-27	2

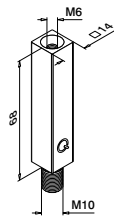

MOD 4811

304	Inox brossé		
INDOOR			
134811		QS-48	2

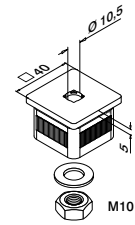

MOD 4733- EASY HIT®

304	Inox brossé		
INDOOR	Pour tube <input type="checkbox"/>		
134733	40 x 40 x 2,0		2



Q-INFO | MOD 4727

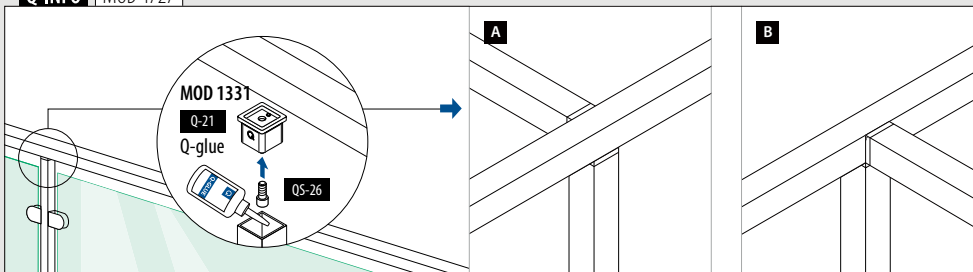

Q-INFO | MOD 4733 / 4811

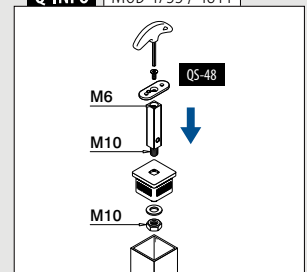

Pour tube plat



MOD 4133

304 Inox brossé

INDOOR

SELL OUT	134133-000-12	QS-55	470 / QS-21	472 / QS-12	472	2



Pour tube plat à tube rond



MOD 4133

304 Inox brossé

INDOOR

SELL OUT	134133-042-12	42,4	QS-55	470 / QS-21	472 / QS-10	472	2

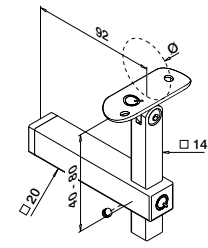

Pour tube plat



MOD 4155

304 Inox brossé

INDOOR

SELL OUT	134155-000-12	QS-12	472	2

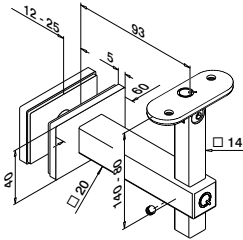

SELL
OUT Seulement jusqu'à épuisement des stocks.

Q-INFO

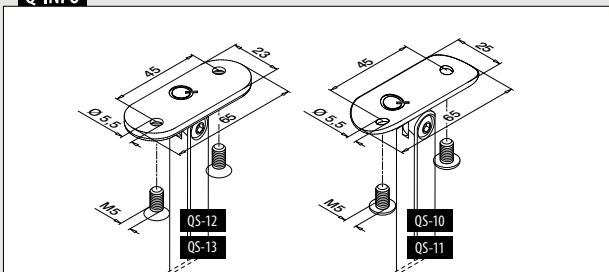

Q-INFO MOD 4155

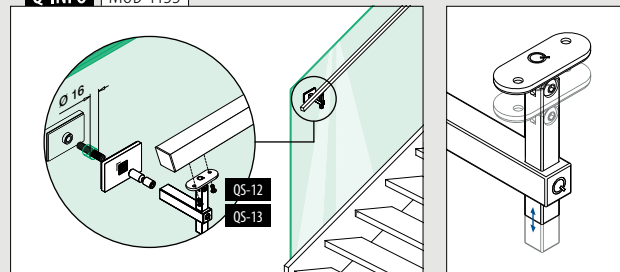

Pour tube plat

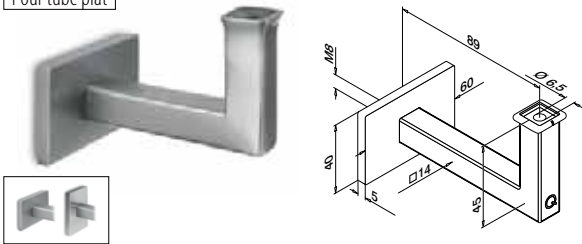

MOD 4111

304	Inox brossé		
INDOOR			
134111-000-12	QS-1 471 / QS-54 472		2
316	Inox brossé		
OUTDOOR			
144111-000-12	QS-2 471 / QS-70 472		2



Pour tube rond

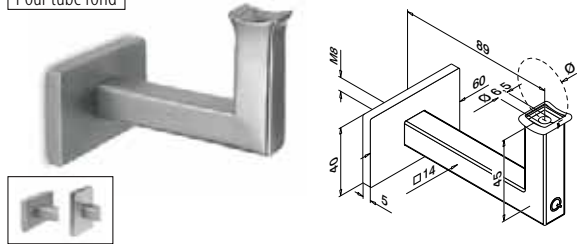

MOD 4111

304	Inox brossé		
INDOOR	Ø		
134111-042-12	42,4 QS-1 471 / QS-54 472		2



Q-INFO | MOD 4111-042

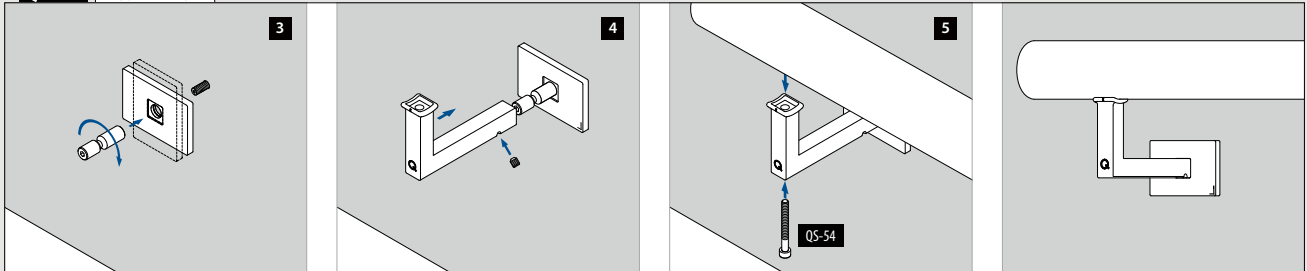

Q-INFO | MOD 4111-042

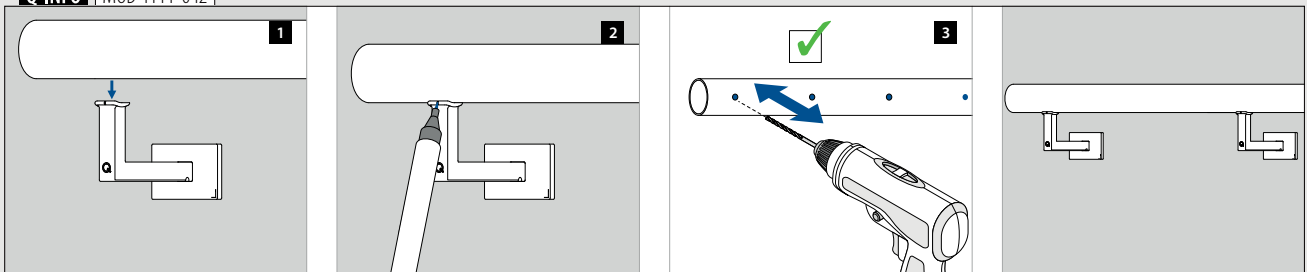

Pour tube plat

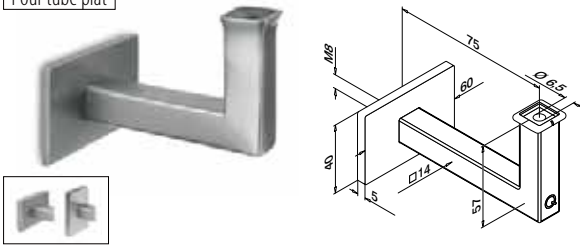

MOD 4121

304 Inox brossé

INDOOR		
134121-000-12	QS-1 471 / QS-54 472	2

316 Inox brossé

OUTDOOR		
144121-000-12	QS-2 471 / QS-70 472	2



Pour tube plat

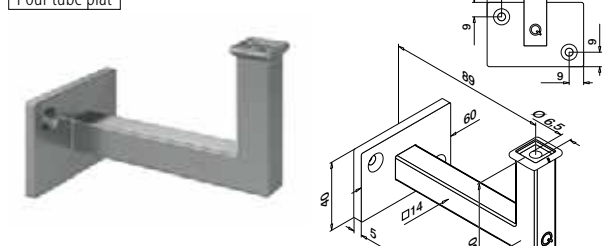

MOD 4112

304 Inox brossé

INDOOR		
134112-000-12	QS-5 471 / QS-54 472	2

316 Inox brossé

OUTDOOR		
NEW 144112-000-12	QS-6 471 / QS-70 472	2



Pour tube plat

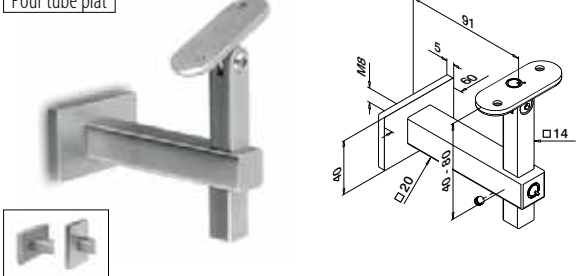

MOD 4145

304 Inox brossé

INDOOR		
134145-000-12	QS-1 471 / QS-12 472	2

316 Inox brossé

OUTDOOR		
SELL OUT 144145-000-12	QS-2 471 / QS-13 472	2



Pour tube rond

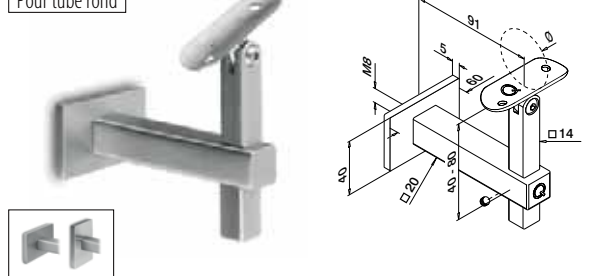

MOD 4145

304 Inox brossé

INDOOR		
134145-042-12	42,4 QS-1 471 / QS-10 472	2

OUTDOOR		



Q-INFO MOD 4145

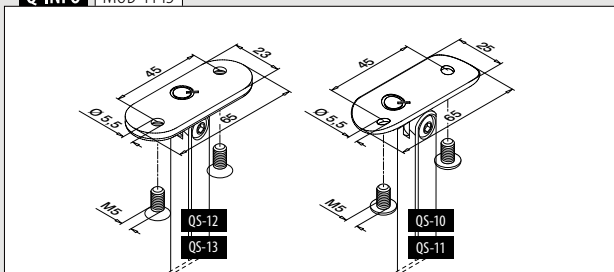

SELL OUT Seulement jusqu'à épuisement des stocks.

Embouts



MOD 5728 - EASY HIT®

304 Inox brossé

INDOOR	Pour tube <input type="checkbox"/>	
135728-040-12	40 x 40 x 2,0	2

304 Black Line

INDOOR		
135728-040-82	40 x 40 x 2,0	2

NEW

316 Inox brossé

OUTDOOR		
145728-040-12	40 x 40 x 2,0	2



Tubes

Q-TUBE

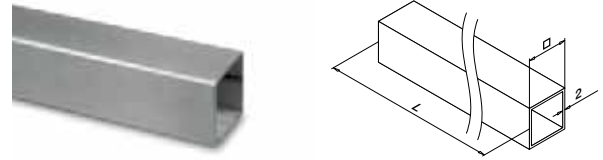

MOD 4900

304 Inox brossé

INDOOR	<input type="checkbox"/>	
134900-040-25-12	40 x 40 x 2,0	L = 2,5 m
134900-040-50-12	40 x 40 x 2,0	L = 5 m

304 Black Line

INDOOR		
134900-040-50-82	40 x 40 x 2,0	L = 5 m

NEW

316 Inox brossé

OUTDOOR		
144900-040-25-12	40 x 40 x 2,0	L = 2,5 m
144900-040-50-12	40 x 40 x 2,0	L = 5 m



Raccords



MOD 5794 - EASY HIT®

316 Brut

OUTDOOR	Pour tube <input type="checkbox"/>	
145794-040	40 x 40 x 2,0	2



International Design Modèle Protection



MOD 4790

304 Inox brossé

INDOOR	Pour tube <input type="checkbox"/>	
134790-040-12	40 x 40 x 2,0	2

316 Inox brossé

OUTDOOR		
144790-040-12	40 x 40 x 2,0	2



Q-INFO | MOD 5794-040

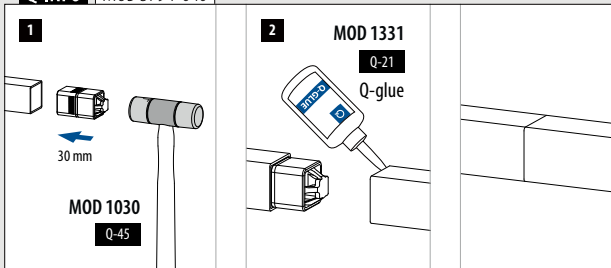

Q-INFO | MOD 4900

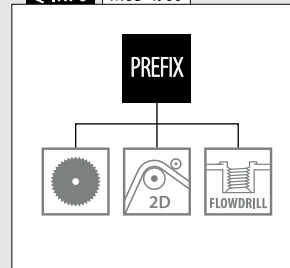

Q-INFO | 304



Raccords

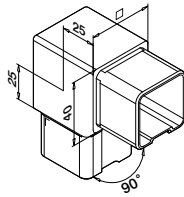

MOD 4301

304	Inox brossé		
INDOOR	Pour tube □		
134301-040-12	40 x 40 x 2,0		2
316	Inox brossé		
OUTDOOR			
144301-040-12	40 x 40 x 2,0		2

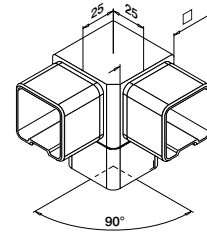

MOD 4304

304	Inox brossé		
INDOOR	Pour tube □		
134304-12	40 x 40 x 2,0		2
316	Inox brossé		
OUTDOOR			
144304-12	40 x 40 x 2,0		2



Raccords

Orientables

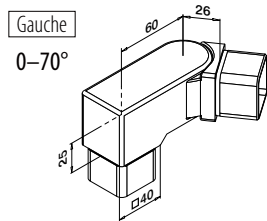

MOD 4317

304	Inox brossé		
INDOOR	Pour tube □		
134317-01	40 x 40 x 2,0		2

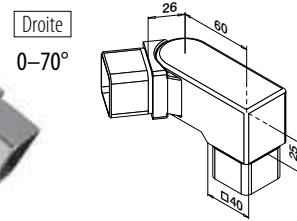

MOD 4317

304	Inox brossé		
INDOOR	Pour tube □		
134317-02	40 x 40 x 2,0		2

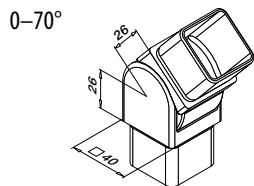

MOD 4312

304	Inox brossé		
INDOOR	Pour tube □		
134312-040-12	40 x 40 x 2,0		2
316	Inox brossé		
OUTDOOR			
144312-040-12	40 x 40 x 2,0		2



Embases murales pour tube

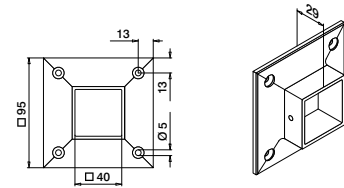

MOD 4505

304	Inox brossé		
INDOOR	Pour tube □		
134505-040-12	40 x 40 x 2,0	QS-5 471	2
316	Inox brossé		
OUTDOOR			
144505-040-12	40 x 40 x 2,0	QS-6 471	2



Q-INFO MOD 4317-01

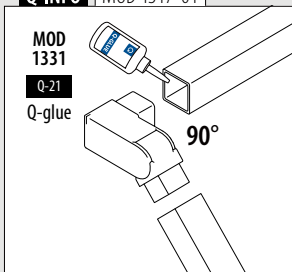

Q-INFO MOD 4317-02

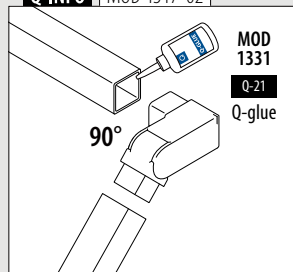



Conçu pour : Utilisation faible à intensive
Utilisation : Intérieur et extérieur
Variante : Montage au sol, latéral et engravé
Applications : Balcons, galeries, passerelles, cloisons, escaliers, pare-vents et protection de fenêtres
Matériau : Acier inoxydable 316 (brossé ou thermolaqué en RAL 9005 noir)

Retrouvez toutes les informations sur Square Line® 60x30 en ligne :



<https://q-ne.ws/SquareLine63-23>

SQUARE LINE® 60x30



Des lignes sobres et une solidité à toute épreuve

Square Line® 60x30 possède un look sans compromis, idéal pour un parti pris audacieux. La main-courante et les poteaux en inox de ce système s'affirment avec des formes géométriques simples et s'adaptent aux configurations exigeant des niveaux de sécurité élevés.

Tests/calculs/certificats internationaux:



- 1 Son poteau ultra-résistant fait de Square Line® 60x30 le garde-corps idéal pour les utilisations plus intensives.
- 2 Créez un look contemporain grâce à son design industriel.



REPLISSAGES SQUARE LINE® 60x30

Verre

- Encadrement pour verre
- Pincés à verre
- Adaptateurs à verre
- Supports de verre



■ 386 - 390

Barre et tube

- Remplissages horizontaux
- Remplissages verticaux

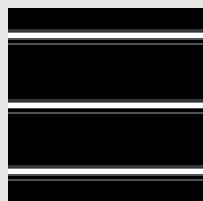

■ 391 - 403

Câble

- Fast Fix Ø 3,2 mm
- Fast Fix Ø 4,0 mm
- Easy Fix Ø 3,2 mm
- Easy Fix Ø 6,0 mm

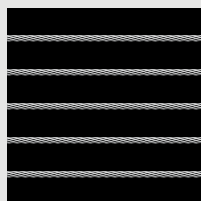

■ 404 - 411

Filet

- Easy Q-web

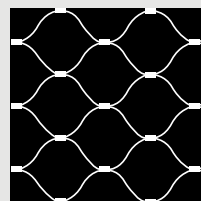

■ 412 - 415

Panneau de tôle

- Pincés à tôle

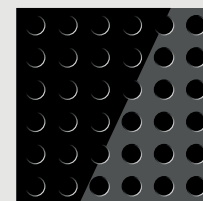

■ 416 - 419

Poteaux

Poteaux

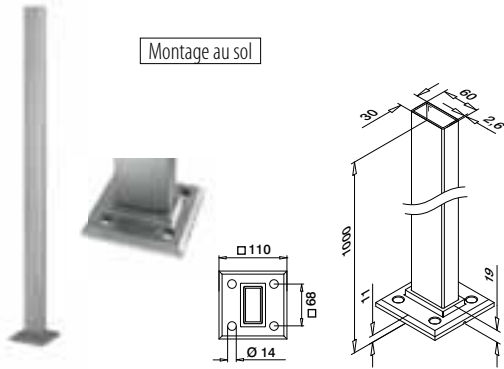

MOD 4901

316	Inox brossé		
OUTDOOR			
144901-063-12	60 x 30 x 2,6	QS-559 465	1
316	Black Line		
OUTDOOR			
NEW 144901-063-82	60 x 30 x 2,6	QS-559 465	1



Poteaux

Tubes prédecoupés

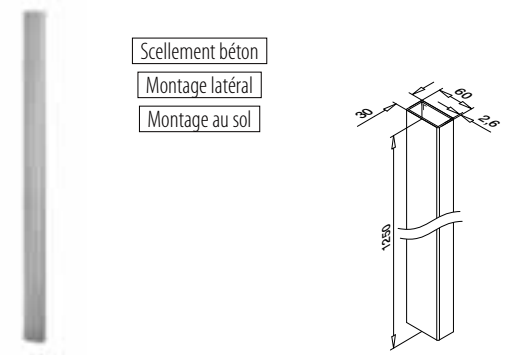

MOD 4902

316	Inox brossé		
OUTDOOR			
144902-063-12	60 x 30 x 2,6		1
PREFIX			

Poteaux

Cache embases

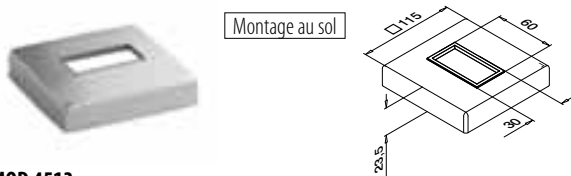

MOD 4513

316	Inox brossé	
OUTDOOR		
144513-063-12		2
316	Black Line	
OUTDOOR		
NEW 144513-063-82		2

Scellement béton



MOD 4512

316	Inox brossé	
OUTDOOR		
144512-063		2

Poteaux

Embases pour poteaux

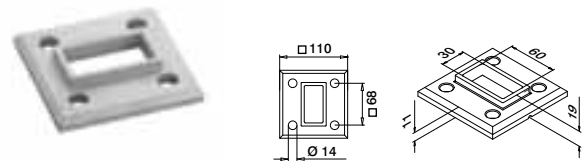

MOD 3503

316	Brut	
OUTDOOR		
143503-063	QS-559 465	2

Q-INFO MOD 4901 / 4902

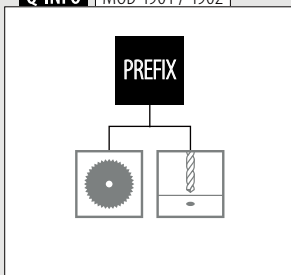

Q-INFO 316



Q-INFO MOD 4901 / 4513

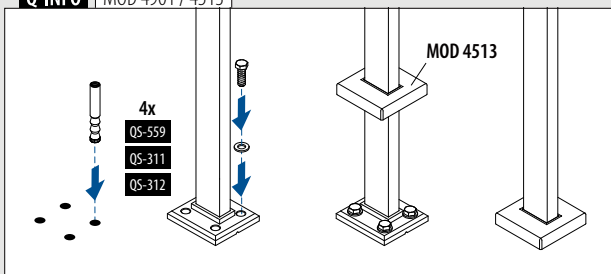

Q-INFO MOD 4902 / 4512

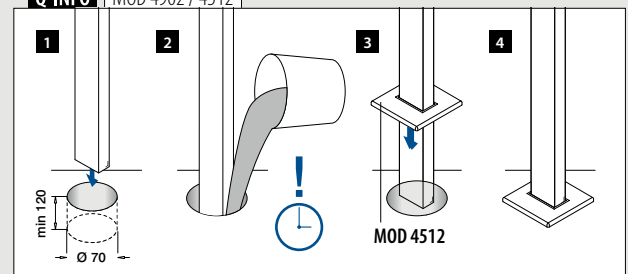

Support mural pour poteau

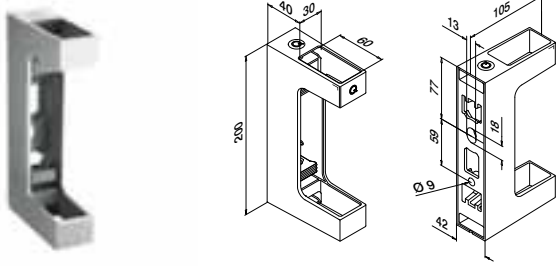

MOD 4558

316	Inox brossé			
OUTDOOR				
144558-063-12	60 x 30	QS-559	465	1
316	Black Line			
OUTDOOR				
NEW 144558-063-82	60 x 30	QS-559	465	1



International Design Modèle Protection

Embouts



MOD 5728 - EASY HIT®

316	Inox brossé			
OUTDOOR	Pour			
144578-063-12	60 x 30 x 2,6			2



International Design Modèle Protection

Tubes

Q-TUBE

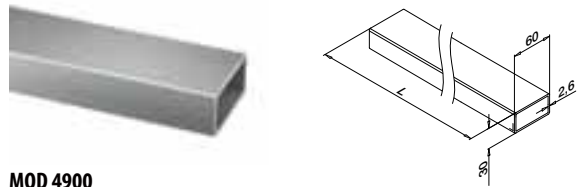

MOD 4900

316	Inox brossé			
OUTDOOR				
144900-063-50-12	60 x 30 x 2,6			L = 5 m



Adaptateurs pour main-courante

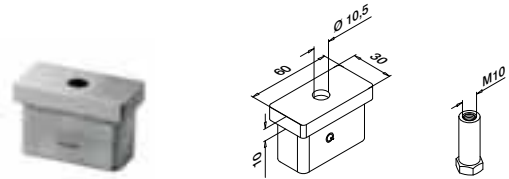

MOD 4725

316	Inox brossé			
OUTDOOR	Pour			
144725-12	60 x 30 x 2,6	QS-48	472	2



MOD 0811	MOD 0812	MOD 4811
335	335	296

MOD 1810	MOD 1801	MOD 1802
337	337	337

Q-INFO MOD 4725

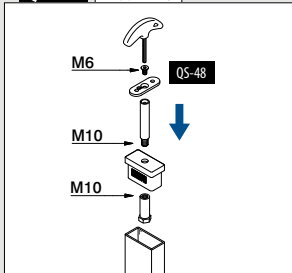

Q-INFO MOD 4900

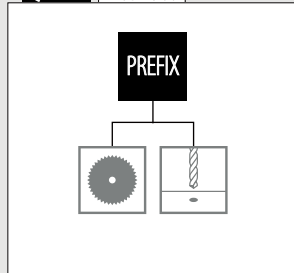

Q-INFO MOD 4558

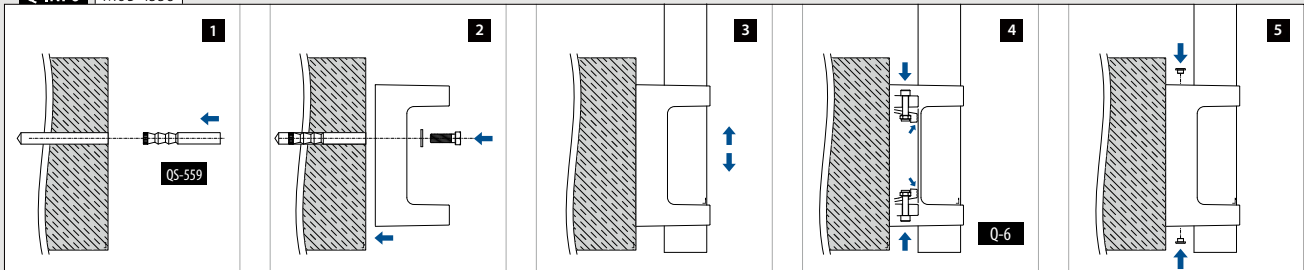

Pour tube plat

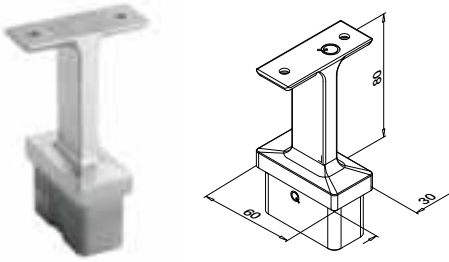

MOD 4711

316 Inox brossé

OUTDOOR

Pour □



144711-000-12 60 x 30 x 2,6

QS-13 472

2

316 Black Line

OUTDOOR

NEW 144711-000-82 60 x 30 x 2,6

QS-13 472

2



Pour tube plat à tube rond

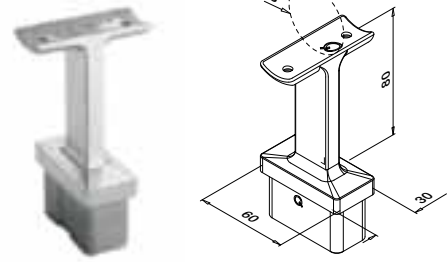

MOD 4711

316 Inox brossé

OUTDOOR

Ø

Pour □



144711-042-12 42,4 60 x 30 x 2,6

QS-13 472

2

SELL OUT

144711-048-12 48,3 60 x 30 x 2,6

QS-13 472

2

316 Black Line

OUTDOOR

NEW

144711-042-82 42,4 60 x 30 x 2,6

QS-13 472

2



Pour tube plat

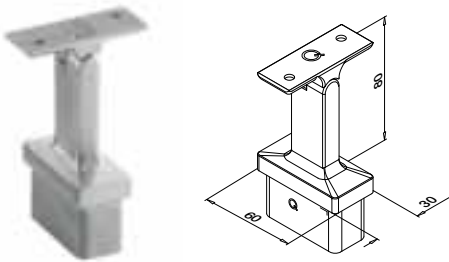

MOD 4719

316 Inox brossé

OUTDOOR

Pour □



144719-000-12 60 x 30 x 2,6

QS-13 472

2



Pour tube plat à tube rond

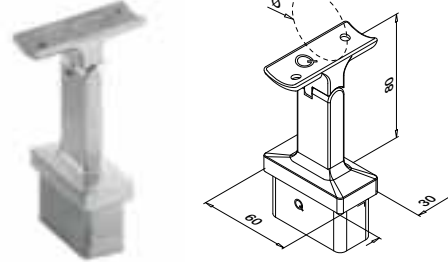

MOD 4719

316 Inox brossé

OUTDOOR

Ø

Pour □



144719-042-12 42,4 60 x 30 x 2,6

QS-13 472

2

SELL OUT

144719-048-12 48,3 60 x 30 x 2,6

QS-13 472

2

 Seulement jusqu'à épuisement des stocks.

Q-INFO MOD 4711

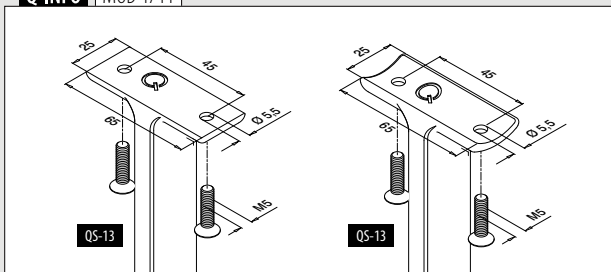

Q-INFO MOD 4719

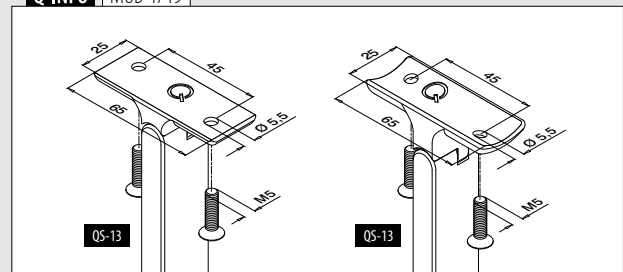

Mains-courantes

Tubes

Q-TUBE

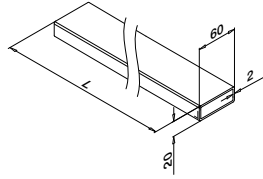

MOD 4900

316	Inox brossé		
OUTDOOR			
144900-062-25-12	60 x 20 x 2,0	L = 2,5 m	
144900-062-50-12	60 x 20 x 2,0	L = 5 m	
316	Black Line		
OUTDOOR			
NEW 144900-062-50-82	60 x 20 x 2,0	L = 5 m	



International Design Modèle Protection

Mains-courantes

Raccords

Orientables



0 - 70°

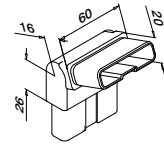

MOD 4312

316	Inox brossé		
OUTDOOR	Pour tube		
144312-062-12	60 x 20 x 2,0		2



International Design Modèle Protection

Mains-courantes

Raccords

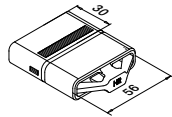

MOD 5794 - EASY HIT®

316	Brut		
OUTDOOR	Pour tube		
145794-062	60 x 20 x 2,0		2



International Design Modèle Protection

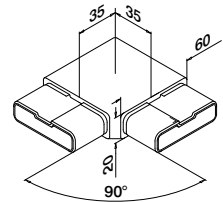

MOD 4301

316	Inox brossé		
OUTDOOR	Pour tube		
144301-062-12	60 x 20 x 2,0		2

316	Black Line		
OUTDOOR			

NEW 144301-062-82	60 x 20 x 2,0		2
--------------------------	---------------	--	---



Mains-courantes

Embouts

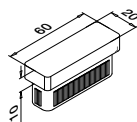

MOD 5728 - EASY HIT®

316	Inox brossé		
OUTDOOR	Pour tube		
145728-062-12	60 x 20 x 2,0		2

316	Black Line		
OUTDOOR			

NEW 145728-062-82	60 x 20 x 2,0		2
--------------------------	---------------	--	---



International Design Modèle Protection

Mains-courantes

Embases murales pour tube

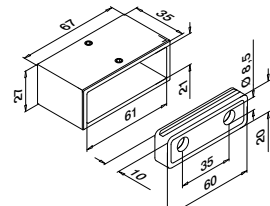

MOD 4504

316	Inox brossé		
OUTDOOR	Pour tube		
144504-062-12	60 x 20 x 2,0	QS-55	470 / QS-27
			472



Q-INFO MOD 5794

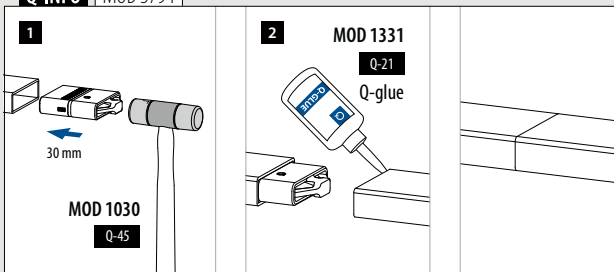

Q-INFO MOD 4900

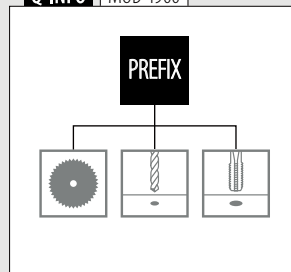

Q-INFO 316



SYSTEMES DE GARDE-CORPS À POTEAUX

SQUARE LINE® 60x20



- Conçu pour :** Utilisation faible à intensive
Utilisation : Intérieur et extérieur
Variante : Montage au sol, latéral et engravé
Applications : Balcons, galeries, passerelles, cloisons, escaliers, pare-vents et protection de fenêtres
Matériau : Acier inoxydable 304 et 316 (brossé, poli miroir ou thermo-laqué en RAL 9005 noir)

Retrouvez toutes les informations sur Q-line en ligne :



<https://q-ne.ws/QLine23>

Q-LINE



Un système aux possibilités infinies

Q-line est certainement notre système le plus polyvalent. Il se décline en une très large gamme d'éléments qui répondent à la plupart des défis architecturaux et à presque toutes les exigences spécifiques. Il vous permet même de créer un garde-corps avec une finition polie miroir intégrale. Pourquoi ne pas lui intégrer des éléments d'autres systèmes pour créer un design totalement unique ? Laissez libre cours à votre imagination.

Tests/calculs/certificats internationaux:



- 1 La gamme Q-line est très variée avec différentes options de surface et de remplissage, des montages au sol et latéraux et même des solutions pour les escaliers.
- 2 Q-line comprend également un poteau à double paroi (montage au sol et latéral) vous permettant de créer un garde-corps avec des poteaux ronds résistants à des charges linéaires plus élevées.

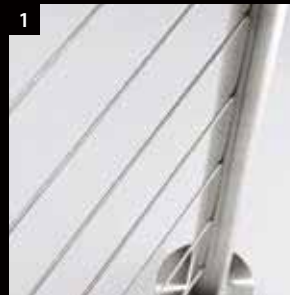

REMPLISSAGES Q-LINE

Verre

- Encadrement pour verre
- Pincés à verre
- Adaptateurs à verre
- Supports de verre



▣ 386 - 390

Barre et tube

- Remplissages horizontaux
- Remplissages verticaux



▣ 391 - 403

Câble

- Fast Fix Ø 3,2 mm
- Fast Fix Ø 4,0 mm
- Easy Fix Ø 3,2 mm
- Easy Fix Ø 6,0 mm

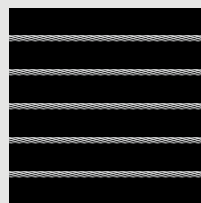

▣ 404 - 411

Filet

- Easy Q-web

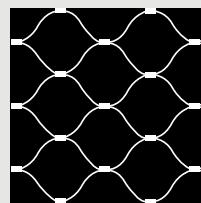

▣ 412 - 415

Panneau de tôle

- Pincés à tôle

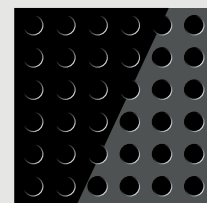

▣ 416 - 419

Poteaux

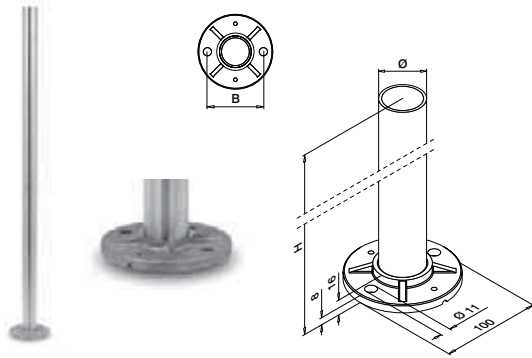

MOD 0921

304		Inox brossé				
INDOOR	Ø	H	B			
130921-242-12	42,4 x 2,0	989	75	QS-59	467 1	
130921-248-12	48,3 x 2,0	989	80	QS-59	467 1	

316		Inox brossé				
OUTDOOR	Ø	H	B			
140921-242-12	42,4 x 2,0	989	75	QS-58	467 1	
140921-248-12	48,3 x 2,0	989	80	QS-58	467 1	

316		Poli miroir				
OUTDOOR	Ø	H	B			
140921-242-10	42,4 x 2,0	989	75	QS-58	467 1	

MOD 0944

316		Inox brossé				
OUTDOOR	Ø	H	B			
140944-242-12	42,4 x 2,0	1150	75	QS-58	467 1	
140944-248-12	48,3 x 2,0	1150	80	QS-58	467 1	

PREFIX



Embases pour poteaux

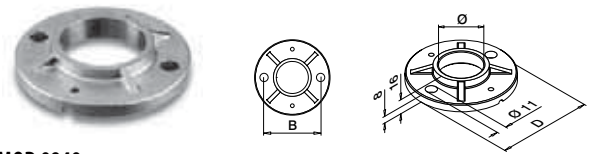

MOD 0940

304		Brut				
INDOOR	Ø	B	D			
130940-042	42,4	75	100	QS-59	467 2	
130940-048	48,3	80	100	QS-59	467 2	

316		Brut				
OUTDOOR	Ø	B	D			
140940-042	42,4	75	100	QS-58	467 2	
140940-048	48,3	80	100	QS-58	467 2	

MOD 0941

316		Brut				
OUTDOOR	Ø	B	D			
140941-048	48,3	90	120	QS-58	467 2	



Cache embases



MOD 0512

304		Inox brossé		
INDOOR	Ø	D		
130512-042-12	42,4	105	2	
130512-048-12	48,3	105	2	

316		Inox brossé		
OUTDOOR	Ø	D		
140512-042-12	42,4	105	2	
140512-048-12	48,3	105	2	

316		Poli miroir		
OUTDOOR	Ø	D		
140512-042-10	42,4	105	2	

MOD 0513

316		Inox brossé		
OUTDOOR	Ø	D		
140513-048-12	48,3	125	2	

Q-INFO 316

10

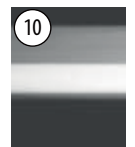

Poli miroir

12



Inox brossé

Poteaux

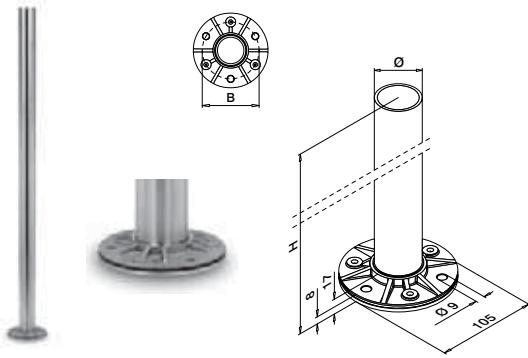

MOD 0912

304		Inox brossé			
INDOOR	Ø	H	B		
130912-242-12	42,4 x 2,0	989	80	QS-35	467 1
316		Inox brossé			
OUTDOOR	Ø	H	B		
140912-242-12	42,4 x 2,0	989	80	QS-34	467 1



Embases pour poteaux

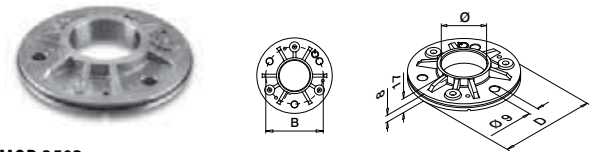

MOD 3502

304		Brut			
INDOOR	Ø	B	D		
133502-042	42,4	80	105	QS-35	467 2
133502-048	48,3	90	115	QS-35	467 2
316		Brut			
OUTDOOR	Ø	B	D		
143502-042	42,4	80	105	QS-34	467 2
143502-048	48,3	90	115	QS-34	467 2



Cache embases

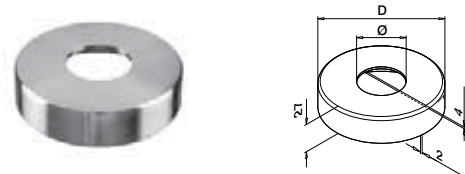

MOD 0511

304		Inox brossé			
INDOOR	Ø	D			
130511-042-12	42,4	110			2
130511-048-12	48,3	120			2
316		Inox brossé			
OUTDOOR	Ø	D			
140511-042-12	42,4	110			2
140511-048-12	48,3	120			2

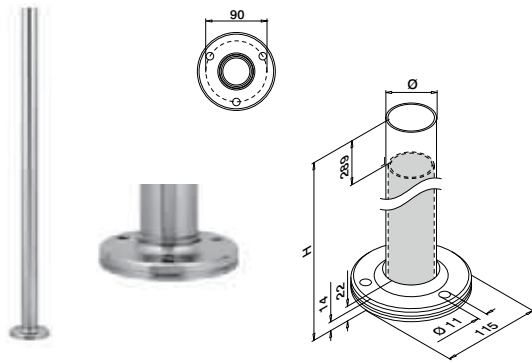

MOD 0916 - DOUBLE ÉPAISSEUR 4,6 mm

304		Inox brossé			
INDOOR	Ø	H			
130916-548-12	48,3 x 4,6	989	QS-272	464	1
316		Inox brossé			
OUTDOOR	Ø	H			
140916-548-12	48,3 x 4,6	989	QS-273	464	1

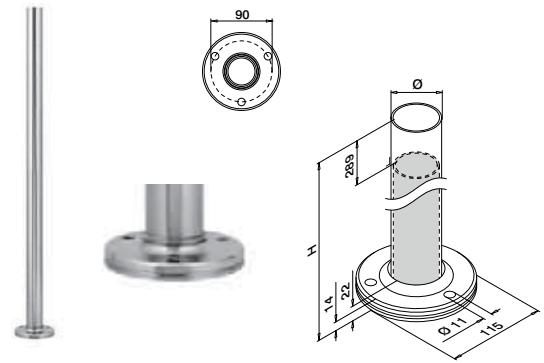

MOD 0917 - DOUBLE ÉPAISSEUR 4,6 mm

316		Inox brossé			
OUTDOOR	Ø	H			
140917-548-12	48,3 x 4,6	1089	QS-273	464	1

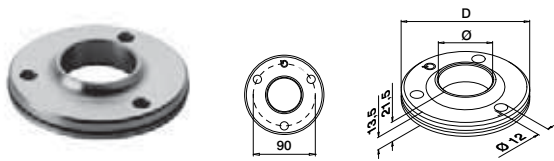

MOD 3505

316		Brut			
OUTDOOR	Ø	D			
143505-048	48,3	115	QS-273	464	2

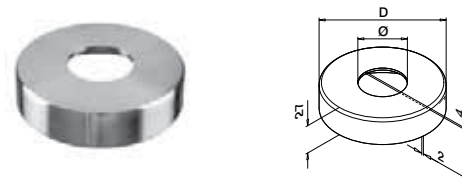

MOD 0511

304		Inox brossé			
INDOOR	Ø	D			
130511-048-12	48,3	120			2
316		Inox brossé			
OUTDOOR	Ø	D			
140511-048-12	48,3	120			2



MOD 0713
324

MOD 0721
326

MOD 0773
333

Q-INFO MOD 0916 / 0917

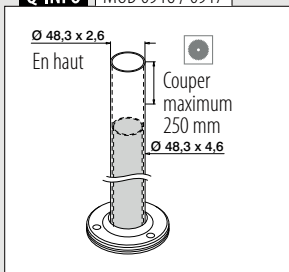

Q-INFO MOD 0916 / 0917

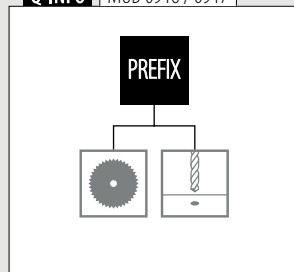

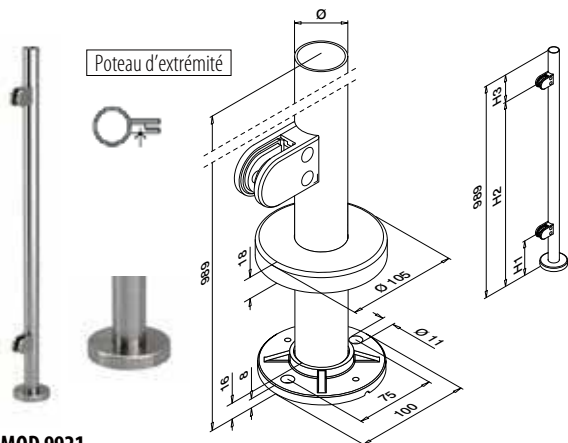

MOD 9921

304	Inox brossé					
INDOOR	Ø	H1	H2	H3		
139921-242-01-12	42,4 x 2,0	175	869	120	QS-59	467 1

316	Inox brossé					
OUTDOOR	Ø	H1	H2	H3		
149921-242-01-12	42,4 x 2,0	175	869	120	QS-58	467 1

NEW

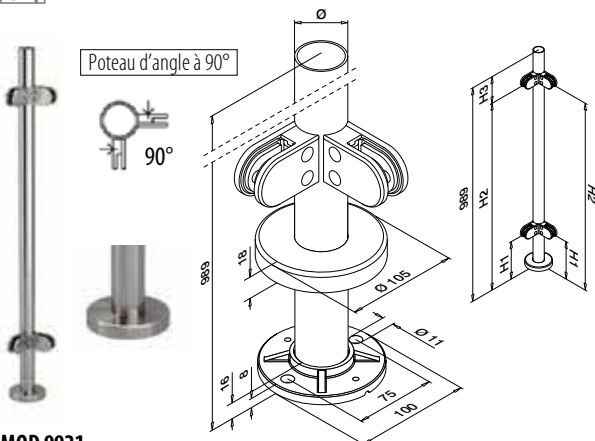

MOD 9921

304	Inox brossé					
INDOOR	Ø	H1	H2	H3		
139921-242-90-12	42,4 x 2,0	175	869	120	QS-59	467 1

316	Inox brossé					
OUTDOOR	Ø	H1	H2	H3		
149921-242-90-12	42,4 x 2,0	175	869	120	QS-58	467 1

NEW

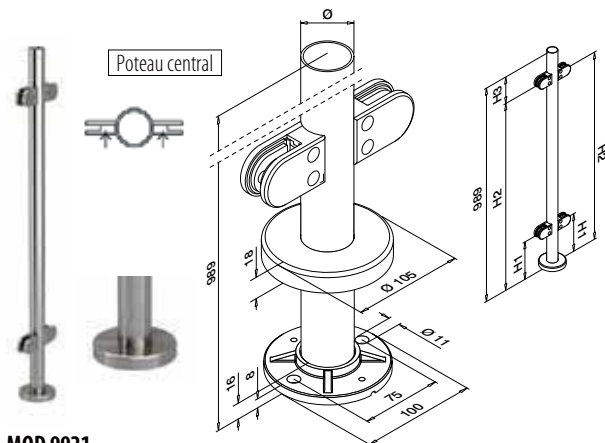

MOD 9921

304	Inox brossé					
INDOOR	Ø	H1	H2	H3		
139921-242-02-12	42,4 x 2,0	175	869	120	QS-59	467 1

316	Inox brossé					
OUTDOOR	Ø	H1	H2	H3		
149921-242-02-12	42,4 x 2,0	175	869	120	QS-58	467 1

NEW



Remplissage

Cales caoutchouc pour pinces à verre MOD 2500



2 pièces par pince à verre

MOD 5025

Accessoires

Pour verre monolithique	T	
205025-06	6	8
205025-08	8	8
205025-10	10	8
205025-12	12	8

Pour verre feuilleté

205025-07	6,76	8
205025-09	8,76	8
NEW 205025-44	9,52	8
205025-11	10,76	8
NEW 205025-54	11,52	8
205025-13	12,76	8



Q-INFO

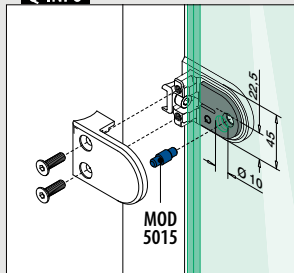

Q-INFO

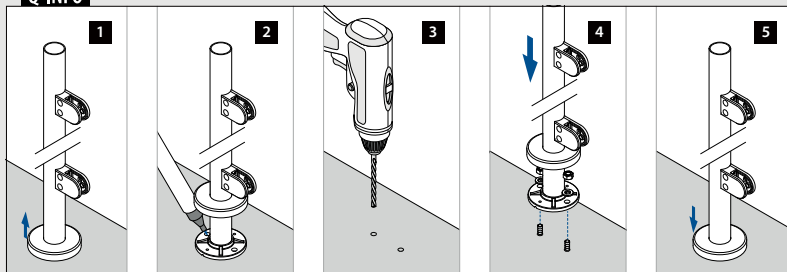

Q-INFO

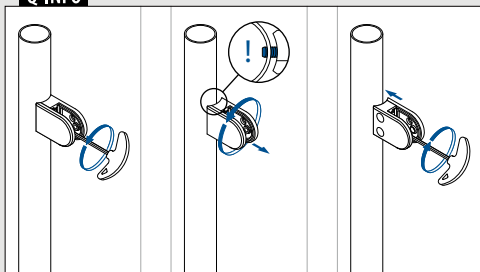

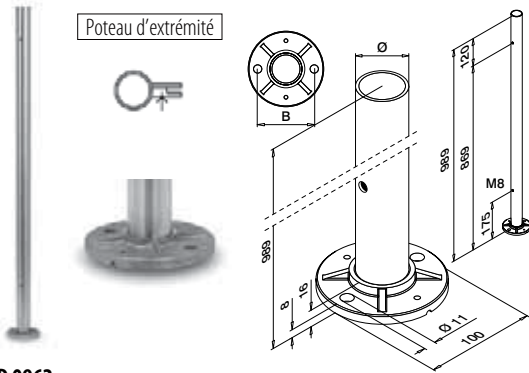

MOD 0962

316		Inox brossé			
OUTDOOR		Ø	B		
140962-242-01-12	42,4 x 2,0	75	QS-58	467	1
140962-248-01-12	48,3 x 2,0	80	QS-58	467	1

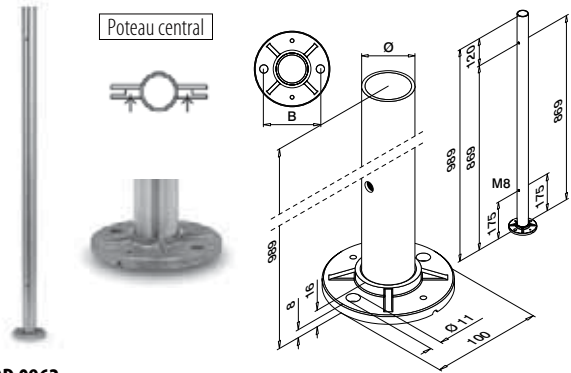

MOD 0962

316		Inox brossé			
OUTDOOR		Ø	B		
140962-242-02-12	42,4 x 2,0	75	QS-58	467	1
140962-248-02-12	48,3 x 2,0	80	QS-58	467	1

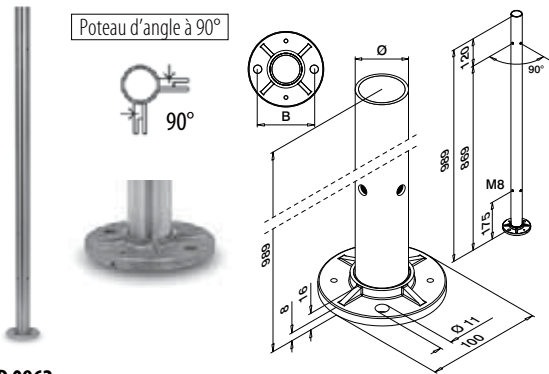

MOD 0962

316		Inox brossé			
OUTDOOR		Ø	B		
140962-242-90-12	42,4 x 2,0	75	QS-58	467	1
140962-248-90-12	48,3 x 2,0	80	QS-58	467	1

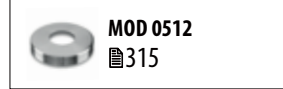

Q-INFO MOD 0962

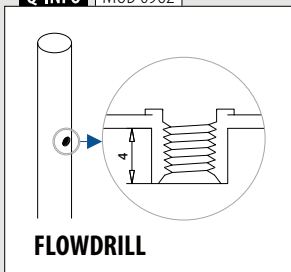

Q-INFO



Voir nos options de préfixe sur mesure poteaux avec pinces en verre, supports de lisses, câble et filet.

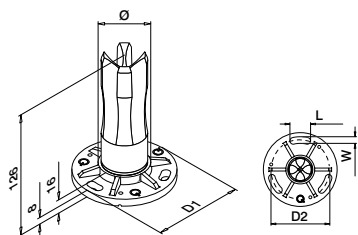

MOD 0942

304		Inox brossé				
INDOOR	Ø	D1	D2	W x L	Q5-35	Q-467
130942-233	33,7 x 2,0	100	80	9x28	Q5-35	Q-467
130942-242	42,4 x 2,0	100	80	9x28	Q5-35	Q-467
130942-248	48,3 x 2,0	100	80	9x28	Q5-35	Q-467
130942-060	60,3 x 2,0	120	90	11x30	Q5-35	Q-467

316		Inox brossé				
OUTDOOR	Ø	D1	D2	W x L	Q5-34	Q-467
140942-233	33,7 x 2,0	100	80	9x28	Q5-34	Q-467
140942-242	42,4 x 2,0	100	80	9x28	Q5-34	Q-467
140942-248	48,3 x 2,0	100	80	9x28	Q5-34	Q-467

SELL OUT

SELL OUT



International Design
Modèle Protection

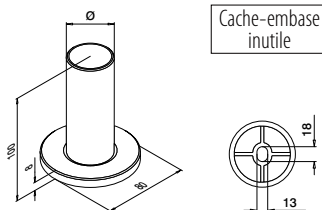

Cache-embase inutile

MOD 0946

304		Inox brossé				
INDOOR	Ø	Q5-33	Q-464			
130946-242-12	42,4 x 2,0	Q5-33	Q-464	2		

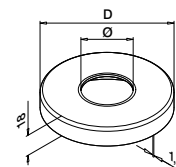

MOD 0512

304		Inox brossé		
INDOOR	Ø	D		
130512-033-12	33,7	105	2	
130512-042-12	42,4	105	2	
130512-048-12	48,3	105	2	

316		Inox brossé		
OUTDOOR	Ø	D		
140512-033-12	33,7	105	2	
140512-042-12	42,4	105	2	
140512-048-12	48,3	105	2	

316		Poli miroir		
OUTDOOR	Ø	D		
140512-042-10	42,4	105	2	

MOD 0513

304		Inox brossé		
INDOOR	Ø	D		
130513-042-12	42,4	125	2	
130513-048-12	48,3	125	2	
130513-060-12	60,3	125	2	

316		Inox brossé		
OUTDOOR	Ø	D		
140513-042-12	42,4	125	2	
140513-048-12	48,3	125	2	

SELL OUT

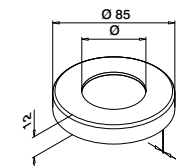

MOD 0516

304		Inox brossé		
INDOOR	Ø			
130516-033	33,7	2		
130516-042	42,4	2		

Q-INFO MOD 0942

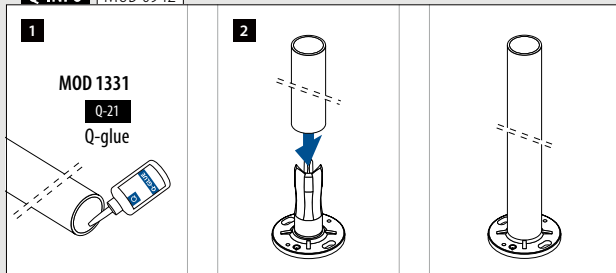

Q-INFO MOD 0946

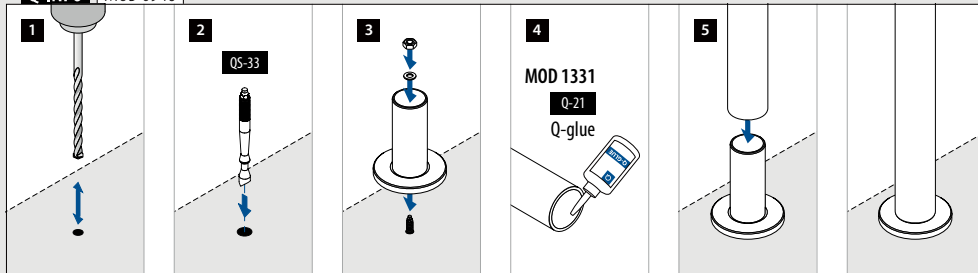

Q-INFO 316

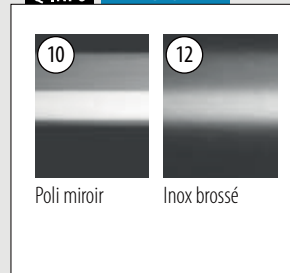

SELL OUT Seulement jusqu'à épuisement des stocks.

Embases-manchons

Angle ajustable Pour collage



+45°
-45°

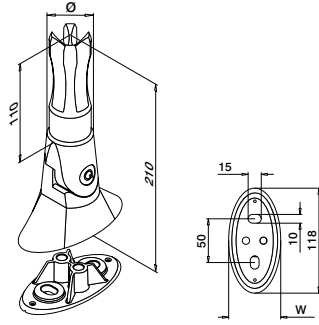

MOD 0945

304		Inox brossé			
INDOOR	Ø	W			
130945-242	42,4 x 2,0	59	QS-65	464	1
130945-248	48,3 x 2,0	65	QS-65	464	1
316		Inox brossé			
OUTDOOR	Ø	W			
140945-242	42,4 x 2,0	59	QS-64	464	1



Tubes prédécoupés

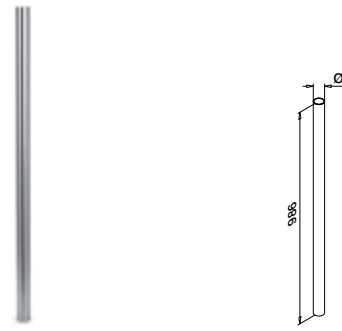

MOD 0901

304		Inox brossé			
INDOOR	Ø				
130901-242-12	42,4 x 2,0				1

PREFIX

Q-INFO MOD 0901

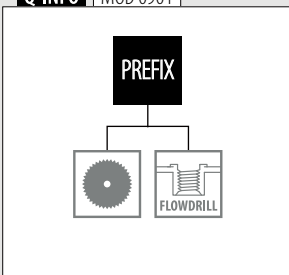

Q-INFO MOD 0945

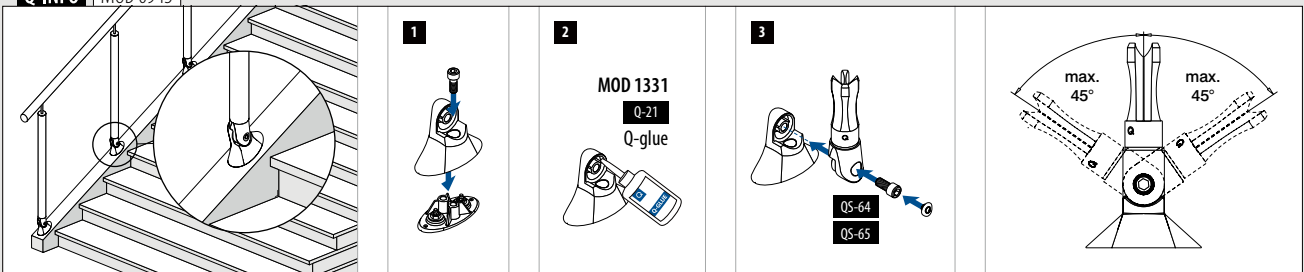

Support mural pour poteau

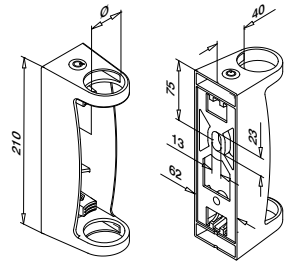
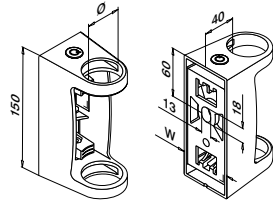

MOD 0557

304		Inox brossé		
INDOOR		Ø		
130557-042-12	42,4	QS-33	464	1
130557-048-12	48,3	QS-33	464	1
316		Inox brossé		
OUTDOOR				
140557-042-12	42,4	QS-32	464	1
140557-048-12	48,3	QS-32	464	1



International Design Modèle Protection

MOD 0558

304		Inox brossé		
INDOOR		Ø		
130558-048-12	48,3	QS-33	464	1
316		Inox brossé		
OUTDOOR				
140558-048-12	48,3	QS-275	464	1



International Design Modèle Protection

Support mural pour poteau

Angle ajustable

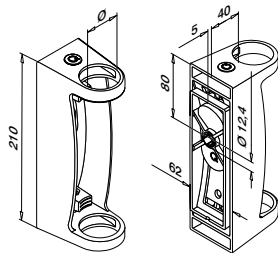

MOD 0556

304		Inox brossé		
INDOOR		Ø		
130556-042	42,4	QS-505	465 / QS-551	472
				1



International Design Modèle Protection

Q-INFO MOD 0557 / 0558

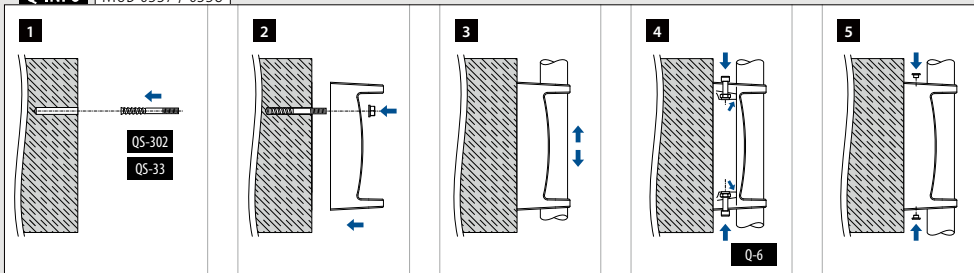

Q-INFO MOD 0556

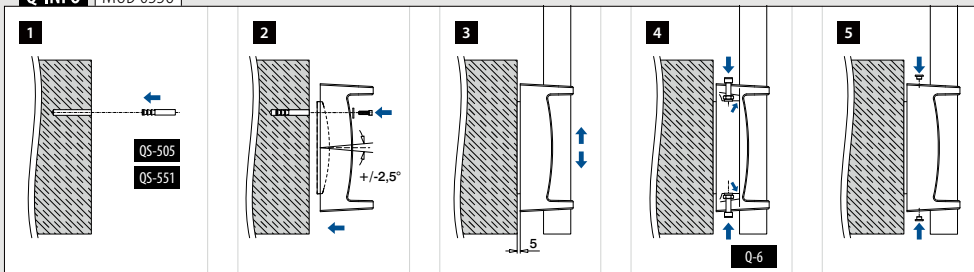

Support mural pour poteau

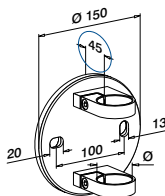

MOD 0551

304		Inox brossé	
INDOOR			
130551-042-12	42,4	QS-33 464	1

304		Poli miroir	
INDOOR			
130551-042-10	42,4	QS-33 464	1

SELL OUT

316		Inox brossé	
OUTDOOR			
140551-042-12	42,4	QS-32 464	1
140551-048-12	48,3	QS-32 464	1

316		Poli miroir	
OUTDOOR			
140551-042-10	42,4	QS-32 464	1

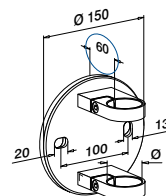

MOD 0552

316		Inox brossé	
OUTDOOR			
140552-042-12	42,4	QS-32 464	1
140552-048-12	48,3	QS-32 464	1



MOD 0550

304		Inox brossé	
INDOOR			
130550-042-12	42,4		2
130550-048-12	48,3		2

316		Inox brossé	
OUTDOOR			
140550-042-12	42,4		2
140550-048-12	48,3		2

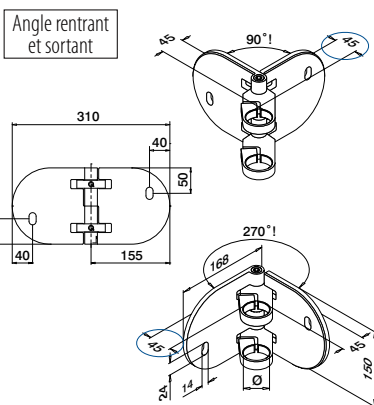

Angle rentrant et sortant

MOD 0555

304		Inox brossé	
INDOOR			
130555-042-12	42,4	QS-33 464	1

316		Inox brossé	
OUTDOOR			
140555-042-12	42,4	QS-32 464	1
140555-048-12	48,3	QS-32 464	1

316		Poli miroir	
OUTDOOR			
140555-042-10	42,4	QS-32 464	1



SELL OUT Seulement jusqu'à épuisement des stocks.

SYSTÈMES DE GARDE-CORPS À POTEAUX Q-LINE

Q-INFO MOD 0551 / 0552 / 0555

MOD 1035
Q-72

Q-INFO 316

10 Poli miroir 12 Inox brossé

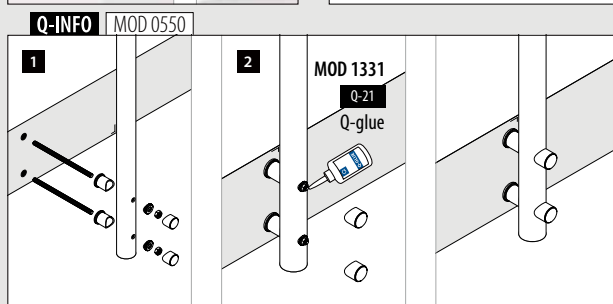
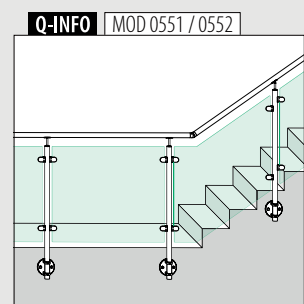
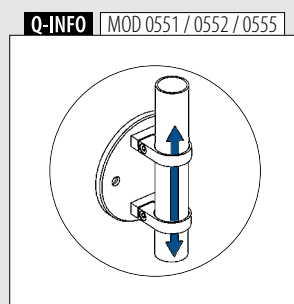

Support mural pour poteau

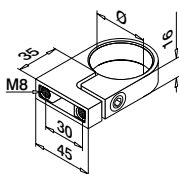

MOD 3507

304		Inox brossé	
INDOOR	Ø		
133507-033-12	33,7		2



Incompatible avec MOD 3508

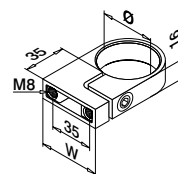

MOD 3507

304		Inox brossé	
INDOOR	Ø	W	
133507-042-12	42,4	50	2
133507-048-12	48,3	55	2

316

316		Inox brossé	
OUTDOOR			
143507-042-12	42,4	50	2
143507-048-12	48,3	55	2



Platine de montage latéral pour MOD 3507



Montage latéral
Pour MOD 3507-04x
Le matériel de fixation pour MOD 3507-04x est inclus

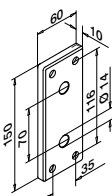

MOD 3508

304		Inox brossé	
INDOOR			
133508-156-12	457 - 463		1
316		Inox brossé	
OUTDOOR			
143508-156-12	457 - 463		1



Montage latéral
Pour MOD 3507-04x
Le matériel de fixation pour MOD 3507-04x est inclus

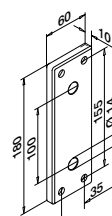

MOD 3508

304		Inox brossé	
INDOOR			
133508-186-12	457 - 463		1
316		Inox brossé	
OUTDOOR			
143508-186-12	457 - 463		1



Montage latéral
Pour MOD 3507-04x
Le matériel de fixation pour MOD 3507-04x est inclus

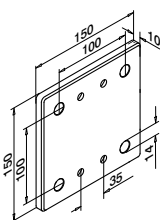

MOD 3508

304		Inox brossé	
INDOOR			
133508-151-12	457 - 463		1
316		Inox brossé	
OUTDOOR			
143508-151-12	457 - 463		1



Q-INFO | MOD 3508-156 / 3507

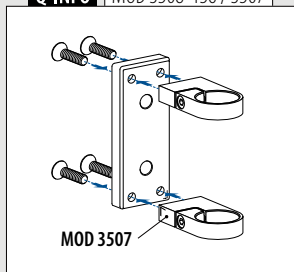

Q-INFO | MOD 3508-186 / 3507

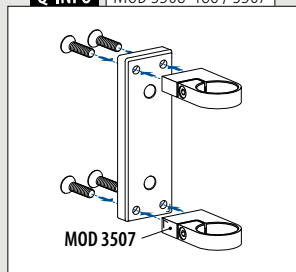

Q-INFO | MOD 3508-151 / 3507

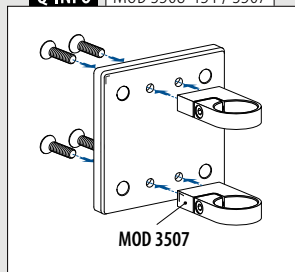

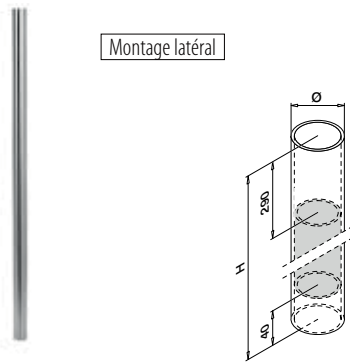

MOD 0951 - DOUBLE ÉPAISSEUR 4,6 mm

304		Inox brossé	
INDOOR	Ø	H	☐
130951-548-12	48,3 x 4,6	1250	1
316		Inox brossé	
OUTDOOR	Ø	H	☐
140951-548-12	48,3 x 4,6	1250	1

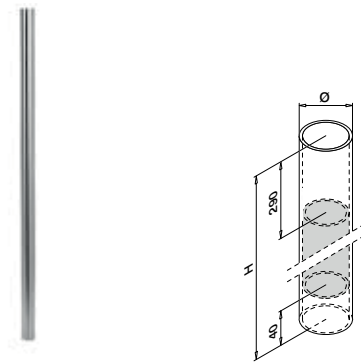

MOD 0952 - DOUBLE ÉPAISSEUR 4,6 mm

304		Inox brossé	
INDOOR	Ø	H	☐
130952-548-12	48,3 x 4,6	1350	1
316		Inox brossé	
OUTDOOR	Ø	H	☐
140952-548-12	48,3 x 4,6	1350	1

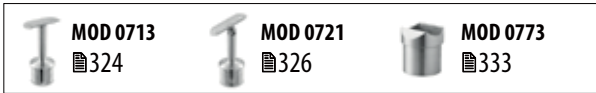
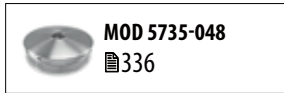

SYSTÈMES DE GARDE-CORPS À POTEAUX

Q-LINE - EXTRA STRONG

Q-INFO

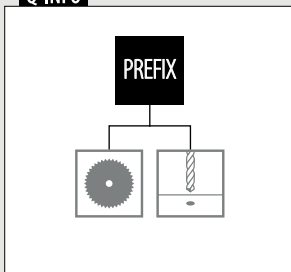

Q-INFO

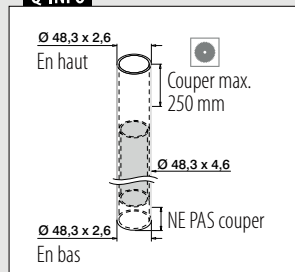

Q-INFO

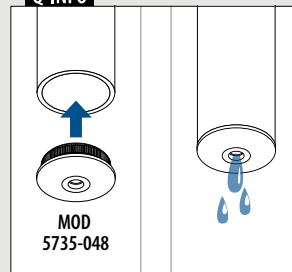

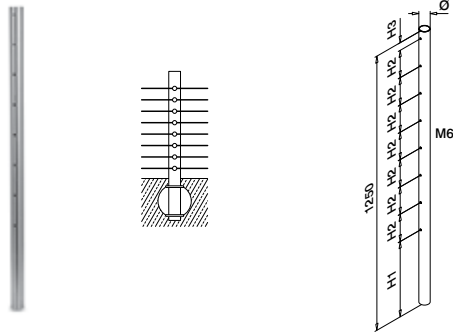

MOD 0935

304		Inox brossé				
INDOOR	Ø	H1	H2	H3		
130935-242-00-12	42,4 x 2,0	340	125	35	1	

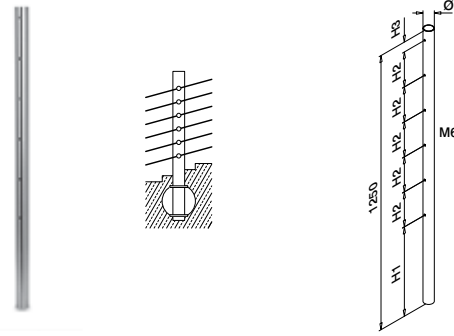

MOD 0935

304		Inox brossé				
INDOOR	Ø	H1	H2	H3		
130935-242-01-12	42,4 x 2,0	405	160	45	1	

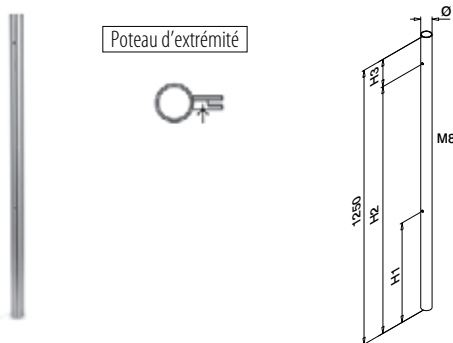

MOD 0937

304		Inox brossé				
INDOOR	Ø	H1	H2	H3		
130937-242-01-12	42,4 x 2,0	455	1130	120	1	

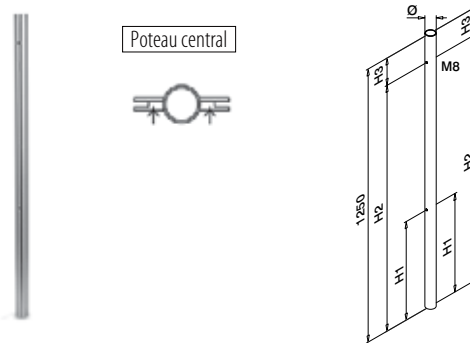

MOD 0937

304		Inox brossé				
INDOOR	Ø	H1	H2	H3		
130937-242-02-12	42,4 x 2,0	455	1130	120	1	

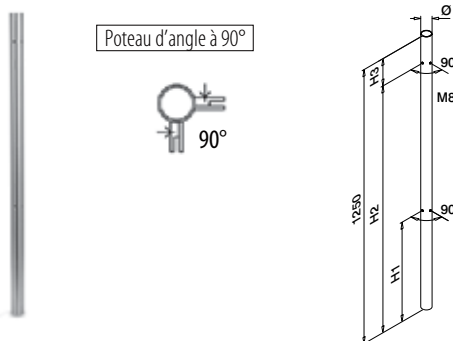

MOD 0937

304		Inox brossé				
INDOOR	Ø	H1	H2	H3		
130937-242-90-12	42,4 x 2,0	455	1130	120	1	

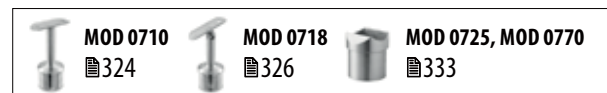
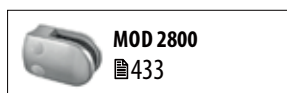

Q-INFO

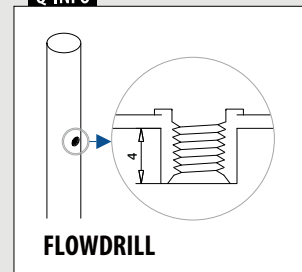

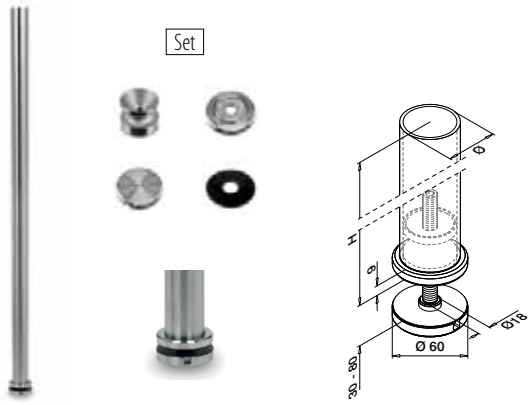

MOD 0545

304	Inox brossé		
INDOOR	Ø	H	
130545	42,4 x 2,0	1150	1

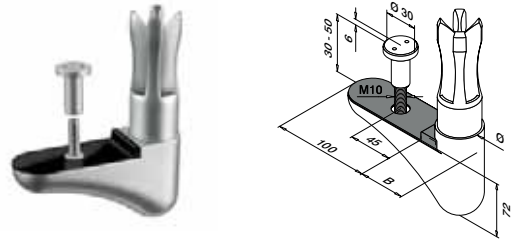

MOD 0947

304	Inox brossé		
INDOOR	Ø	B	
130947-242	42,4 x 2,0	48	1



International Design Modèle Protection



MOD 0947

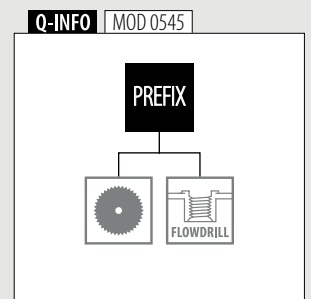
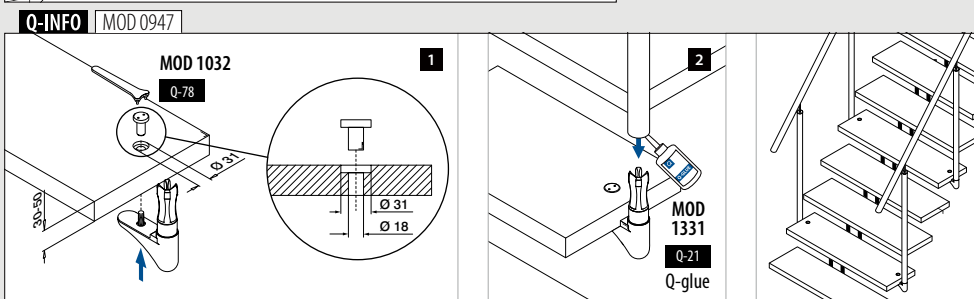
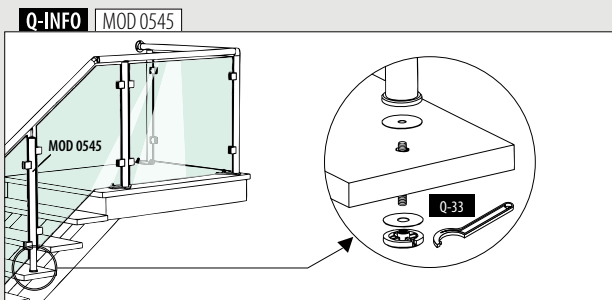

Insert à souder

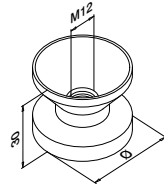

MOD 3501

304 Brut

INDOOR

Ø



133501-242 42,4 x 2,0

QS-274 464

2

133501-042 42,4 x 2,6

QS-274 464

2

SELL
OUT

Rondelle de calage

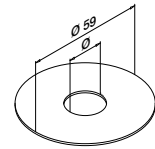

MOD 5080 / 5081

Accessoires

Ø



205080

18

20

205081

12

20

Rosace

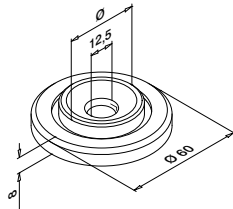

MOD 0501

304 Inox brossé

INDOOR

Ø



130501-042 42,4 x 2,0 + 42,4 x 2,6

2

Cache embases

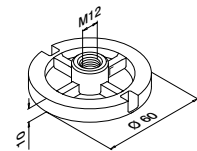

MOD 0731

304 Inox brossé

INDOOR



130731

2



Q-INFO MOD 3501

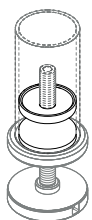

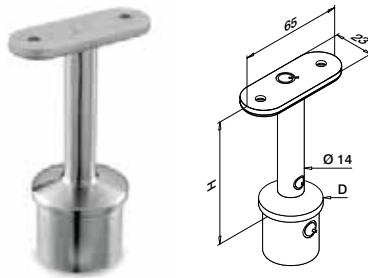
Pour tube plat
à tube rond**MOD 0709**

304		Inox brossé			
INDOOR	D	H			
130709-000-00-12	33,7 x 2,0	80	QS-12		2

MOD 0710

304		Inox brossé			
INDOOR	D	H			
130710-000-00-12	42,4 x 2,0	81	QS-12		2
316		Inox brossé			
OUTDOOR	D	H			
140710-000-00-12	42,4 x 2,0	81	QS-13		2

MOD 0711

304		Inox brossé			
INDOOR	D	H			
130711-000-00-12	48,3 x 2,0	82	QS-12		2

MOD 0712

304		Inox brossé			
INDOOR	D	H			
130712-000-00-12	42,4 x 2,6	81	QS-12		2
316		Inox brossé			
OUTDOOR	D	H			
140712-000-00-12	42,4 x 2,6	81	QS-13		2

MOD 0713

316		Inox brossé			
OUTDOOR	D	H			
140713-000-00-12	48,3 x 2,6	82	QS-13		2

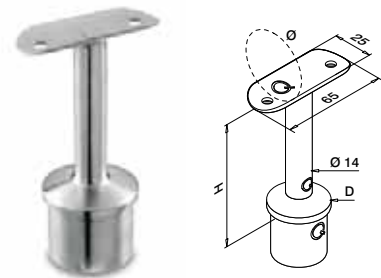

Pour tube rond

**MOD 0709**

304		Inox brossé			
INDOOR	D	Ø	H		
130709-033-00-12	33,7 x 2,0	33,7	78	QS-10	2
130709-042-00-12	33,7 x 2,0	42,4	78	QS-10	2

MOD 0710

304		Inox brossé			
INDOOR	D	Ø	H		
130710-042-00-12	42,4 x 2,0	42,4	79	QS-10	2
130710-048-00-12	42,4 x 2,0	48,3	79	QS-10	2
316		Inox brossé			
OUTDOOR	D	Ø	H		
140710-042-00-12	42,4 x 2,0	42,4	79	QS-11	2
316		Poli miroir			
OUTDOOR	D	Ø	H		
140710-042-00-10	42,4 x 2,0	42,4	79	QS-11	2

MOD 0711

304		Inox brossé			
INDOOR	D	Ø	H		
130711-048-00-12	48,3 x 2,0	48,3	80	QS-10	2
316		Inox brossé			
OUTDOOR	D	Ø	H		
140711-048-00-12	48,3 x 2,0	48,3	80	QS-11	2

MOD 0712

304		Inox brossé			
INDOOR	D	Ø	H		
130712-042-00-12	42,4 x 2,6	42,4	79	QS-10	2
130712-048-00-12	42,4 x 2,6	48,3	79	QS-10	2
316		Inox brossé			
OUTDOOR	D	Ø	H		
140712-042-00-12	42,4 x 2,6	42,4	79	QS-11	2

MOD 0713

304		Inox brossé			
INDOOR	D	Ø	H		
130713-042-00-12	48,3 x 2,6	42,4	80	QS-10	2
130713-048-00-12	48,3 x 2,6	48,3	80	QS-10	2
316		Inox brossé			
OUTDOOR	D	Ø	H		
140713-042-00-12	48,3 x 2,6	42,4	80	QS-11	2
140713-048-00-12	48,3 x 2,6	48,3	80	QS-11	2

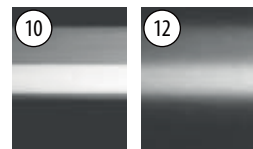
**Q-INFO** 316

Poli miroir

Inox brossé

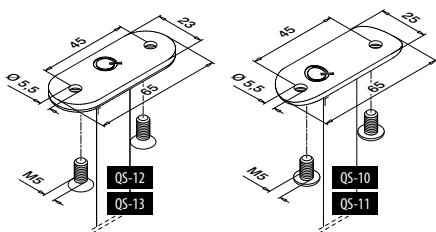
Q-INFO

SELL OUT Seulement jusqu'à épuisement des stocks.

Pour tube rond

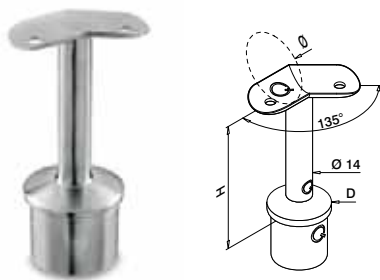

MOD 0710

304		Inox brossé				
INDOOR	D	Ø	H			
130710-042-45-12	42,4 x 2,0	42,4	79	QS-10	472 2	
316		Inox brossé				
OUTDOOR						
140710-042-45-12	42,4 x 2,0	42,4	79	QS-11	472 2	

MOD 0711

316		Inox brossé				
OUTDOOR	D	Ø	H			
140711-048-45-12	48,3 x 2,0	48,3	80	QS-11	472 2	

MOD 0712

304		Inox brossé				
INDOOR	D	Ø	H			
130712-042-45-12	42,4 x 2,6	42,4	79	QS-10	472 2	
316		Inox brossé				
OUTDOOR						
140712-042-45-12	42,4 x 2,6	42,4	79	QS-11	472 2	

MOD 0713

316		Inox brossé				
OUTDOOR	D	Ø	H			
140713-048-45-12	48,3 x 2,6	48,3	80	QS-11	472 2	

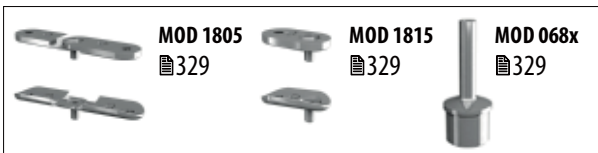

Pour tube rond

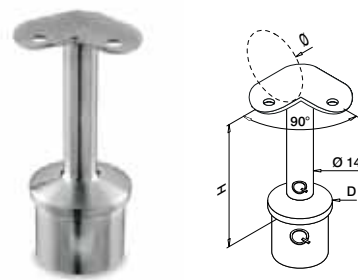

MOD 0709

304		Inox brossé				
INDOOR	D	Ø	H			
130709-033-90-12	33,7 x 2,0	33,7	78	QS-10	472 2	
130709-042-90-12	33,7 x 2,0	42,4	78	QS-10	472 2	

MOD 0710

304		Inox brossé				
INDOOR	D	Ø	H			
130710-042-90-12	42,4 x 2,0	42,4	79	QS-10	472 2	
130710-048-90-12	42,4 x 2,0	48,3	79	QS-10	472 2	

316		Inox brossé				
OUTDOOR						
140710-042-90-12	42,4 x 2,0	42,4	79	QS-11	472 2	

316		Poli miroir				
OUTDOOR						
140710-042-90-10	42,4 x 2,0	42,4	79	QS-11	472 2	

MOD 0711

304		Inox brossé				
INDOOR	D	Ø	H			
130711-048-90-12	48,3 x 2,0	48,3	80	QS-10	472 2	

316		Inox brossé				
OUTDOOR						
140711-048-90-12	48,3 x 2,0	48,3	80	QS-11	472 2	

MOD 0712

304		Inox brossé				
INDOOR	D	Ø	H			
130712-042-90-12	42,4 x 2,6	42,4	79	QS-10	472 2	

316		Inox brossé				
OUTDOOR						
140712-042-90-12	42,4 x 2,6	42,4	79	QS-11	472 2	

MOD 0713

304		Inox brossé				
INDOOR	D	Ø	H			
130713-042-90-12	48,3 x 2,6	42,4	80	QS-10	472 2	
130713-048-90-12	48,3 x 2,6	48,3	80	QS-10	472 2	

316		Inox brossé				
OUTDOOR						
140713-048-90-12	48,3 x 2,6	48,3	80	QS-11	472 2	



Q-INFO | MOD 071x-04x-45

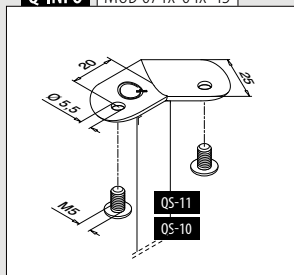

Q-INFO | MOD 071x-04x-45

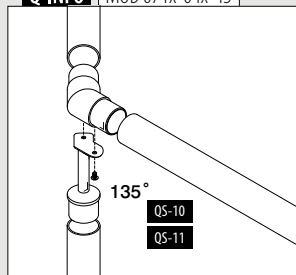

Q-INFO | MOD 07xx-04x-90

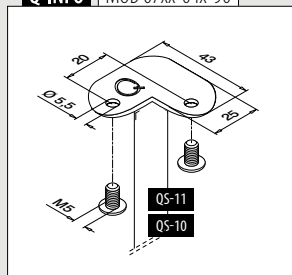

Q-INFO | MOD 07xx-04x-90

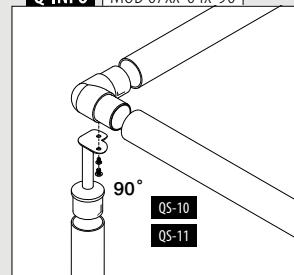

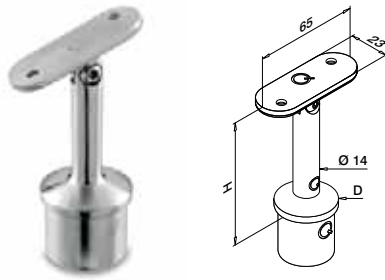
Pour tube plat
à tube rond**MOD 0717****304** Inox brossé

SELL OUT	INDOOR	D	H		
	130717-000-12	33,7 x 2,0	80	QS-12	472 2

MOD 0718**304** Inox brossé

INDOOR	D	H		
130718-000-12	42,4 x 2,0	81	QS-12	472 2

MOD 0720**304** Inox brossé

SELL OUT	INDOOR	D	H		
	130720-000-12	42,4 x 2,6	81	QS-12	472 2

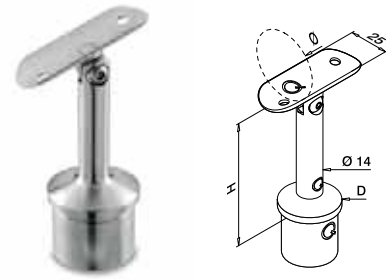

Pour tube rond

**MOD 0717****304** Inox brossé

INDOOR	D	Ø	H		
130717-033-12	33,7 x 2,0	33,7	78	QS-10	472 2
130717-042-12	33,7 x 2,0	42,4	78	QS-10	472 2

MOD 0718**304** Inox brossé

INDOOR	D	Ø	H		
130718-042-12	42,4 x 2,0	42,4	79	QS-10	472 2
130718-048-12	42,4 x 2,0	48,3	79	QS-10	472 2

316 Inox brossé

OUTDOOR	D	Ø	H		
140718-042-12	42,4 x 2,0	42,4	79	QS-11	472 2
140718-048-12	42,4 x 2,0	48,3	79	QS-11	472 2

316 Poli miroir

OUTDOOR	D	Ø	H		
140718-042-10	42,4 x 2,0	42,4	79	QS-11	472 2

MOD 0719**304** Inox brossé

INDOOR	D	Ø	H		
130719-048-12	48,3 x 2,0	48,3	80	QS-10	472 2

316 Inox brossé

OUTDOOR	D	Ø	H		
140719-048-12	48,3 x 2,0	48,3	80	QS-11	472 2

MOD 0720**304** Inox brossé

SELL OUT	INDOOR	D	Ø	H		
	130720-042-12	42,4 x 2,6	42,4	79	QS-10	472 2
	130720-048-12	42,4 x 2,6	48,3	79	QS-10	472 2

316 Inox brossé

SELL OUT	OUTDOOR	D	Ø	H		
	140720-042-12	42,4 x 2,6	42,4	79	QS-11	472 2

MOD 0721**304** Inox brossé

INDOOR	D	Ø	H		
130721-042-12	48,3 x 2,6	42,4	80	QS-10	472 2
130721-048-12	48,3 x 2,6	48,3	80	QS-10	472 2

316 Inox brossé

OUTDOOR	D	Ø	H		
140721-042-12	48,3 x 2,6	42,4	80	QS-11	472 2
140721-048-12	48,3 x 2,6	48,3	80	QS-11	472 2

Q-INFO **304** **316**

10



Poli miroir

12

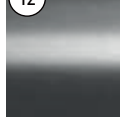

Inox brossé

Q-INFO

1

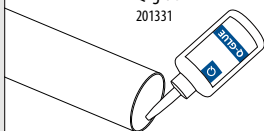
Q-21
Q-glue
201331

2

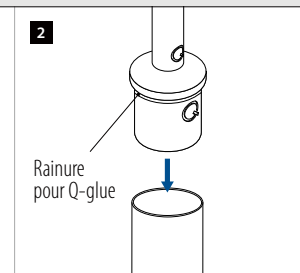
Rainure
pour Q-glue

Q-INFO

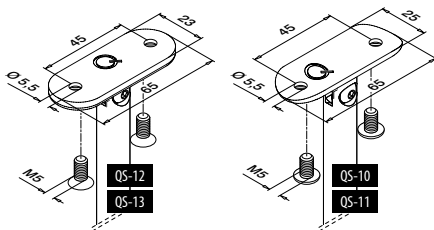



Pour tube plat

Le matériel de fixation pour MOD 068x est inclus

**MOD 1805****304**

Inox brossé

INDOOR

131805-000-12	QS-12 472	2
---------------	-----------	---

316

Inox brossé

OUTDOOR

141805-000-12	QS-13 472	2
---------------	-----------	---

NEW

Pour tube rond

Le matériel de fixation pour MOD 068x est inclus

**MOD 1805****304**

Inox brossé

INDOOR

131805-042-12	42,4	QS-10 472	2
131805-048-12	48,3	QS-10 472	2

316

Inox brossé

OUTDOOR

141805-042-12	42,4	QS-11 472	2
141805-048-12	48,3	QS-11 472	2

NEW

Pour tube plat

Le matériel de fixation pour MOD 068x est inclus

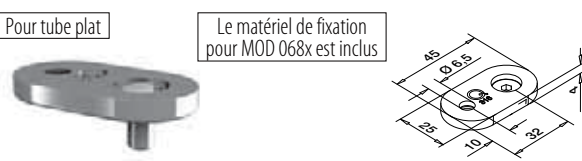
**MOD 1815****304**

Inox brossé

INDOOR

131815-000-12	QS-12 472	2
---------------	-----------	---

316

Inox brossé

OUTDOOR

141815-000-12	QS-13 472	2
---------------	-----------	---

NEW

Pour tube rond

Le matériel de fixation pour MOD 068x est inclus

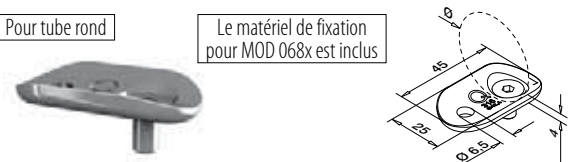
**MOD 1815****304**

Inox brossé

INDOOR

131815-042-12	42,4	QS-10 472	2
131815-048-12	48,3	QS-10 472	2

316

Inox brossé

OUTDOOR

141815-042-12	42,4	QS-11 472	2
141815-048-12	48,3	QS-11 472	2

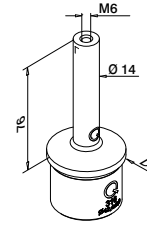
NEW**MOD 0685****304**

Inox brossé

INDOOR

130685-12	42,4 x 2,0	2
-----------	------------	---

316

Inox brossé

OUTDOOR

140685-12	42,4 x 2,0	2
-----------	------------	---

MOD 0686**304**

Inox brossé

INDOOR

130686-12	48,3 x 2,0	2
-----------	------------	---

316

Inox brossé

OUTDOOR

140686-12	48,3 x 2,0	2
-----------	------------	---

MOD 0687**304**

Inox brossé

INDOOR

130687-12	42,4 x 2,6	2
-----------	------------	---

316

Inox brossé

OUTDOOR

140687-12	42,4 x 2,6	2
-----------	------------	---

MOD 0688**304**

Inox brossé

INDOOR

130688-12	48,3 x 2,6	2
-----------	------------	---

316

Inox brossé

OUTDOOR

140688-12	48,3 x 2,6	2
-----------	------------	---

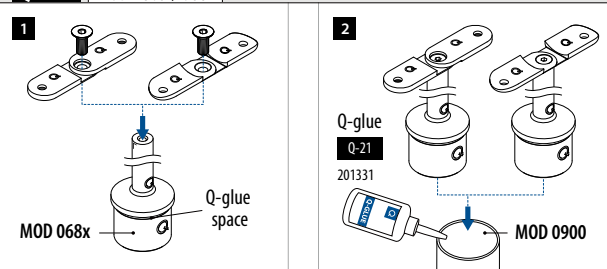
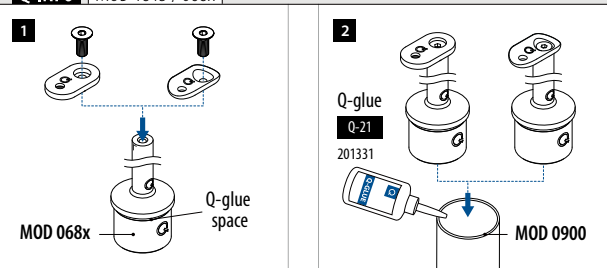
NEW**Q-INFO | MOD 1805 / 068x****Q-INFO | MOD 1815 / 068x**

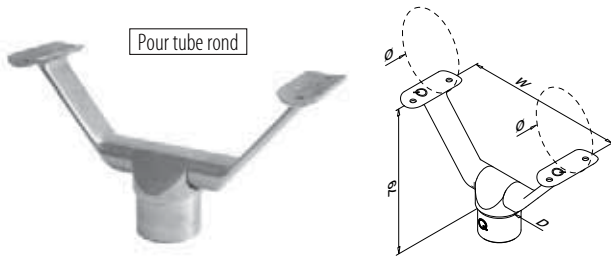

MOD 0693

316	Inox brossé				
OUTDOOR	D	Ø	W		
140693-042-12	42,4 x 2,0	42,4	170	QS-11	472 2

MOD 0694

316	Inox brossé				
OUTDOOR	D	Ø	W		
140694-048-12	48,3 x 2,0	48,3	194	QS-11	472 2



International Design Modèle Protection

Cintres

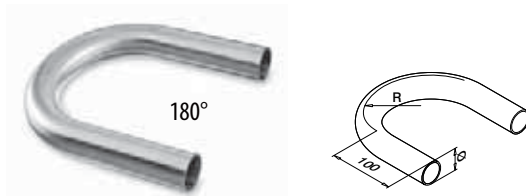

MOD 0906

304	Inox brossé		
INDOOR	Ø	R	
130906-242-12	42,4 x 2,0	85	1
130906-248-12	48,3 x 2,0	97	1
316	Inox brossé		
OUTDOOR	Ø	R	
140906-242-12	42,4 x 2,0	85	1
140906-248-12	48,3 x 2,0	97	1

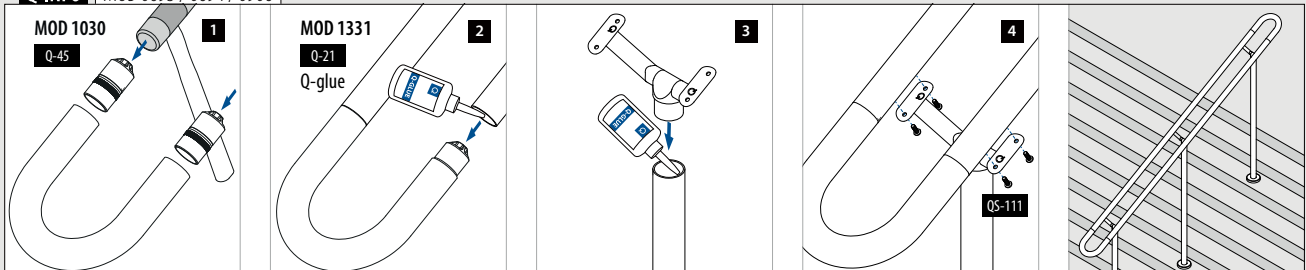
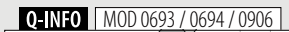
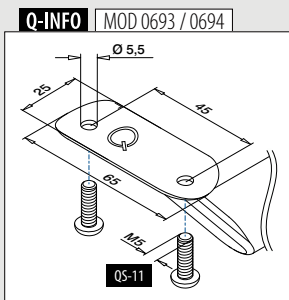

Pour tube rond

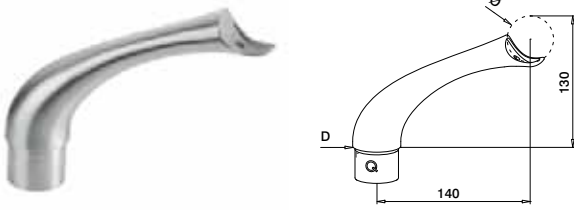

MOD 0706

304		Inox brossé			
INDOOR	D	Ø			
130706	42,4 x 2,0	42,4	QS-83	472	2
316		Inox brossé			
OUTDOOR	D	Ø			
140706	42,4 x 2,0	42,4	QS-84	472	2



International Design Modèle Protection

Pour tube rond

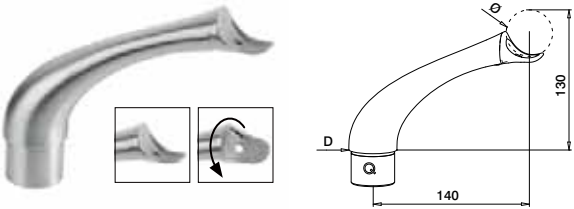

MOD 0704

316		Inox brossé			
OUTDOOR	D	Ø			
140704	42,4 x 2,0	42,4	QS-84	472	2



International Design Modèle Protection

Pour tube rond

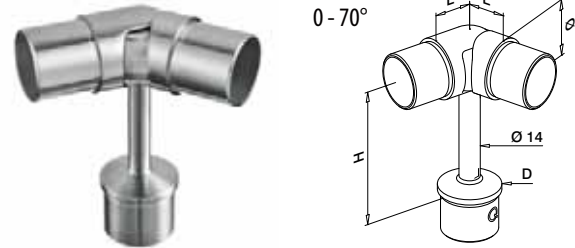

MOD 0736

304		Inox brossé			
INDOOR	D	Ø	H	L	
130736-242	42,4 x 2,0	42,4 x 2,0	100	27	2
316		Inox brossé			
OUTDOOR	D	Ø	H	L	
140736-242	42,4 x 2,0	42,4 x 2,0	100	27	2

MOD 0737

316		Inox brossé			
OUTDOOR	D	Ø	H	L	
140737-248	48,3 x 2,0	48,3 x 2,0	100	30	2



Q-INFO MOD 0704

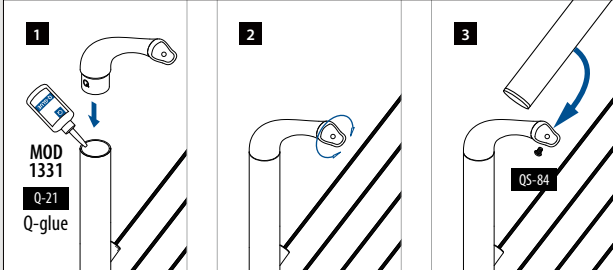

Q-INFO MOD 0706

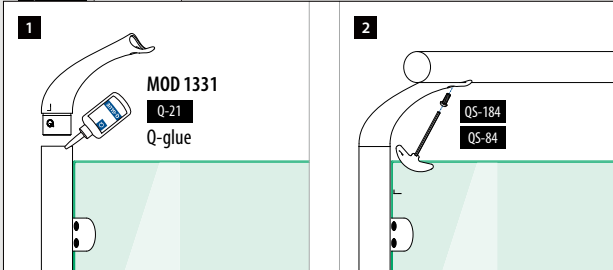

Q-INFO

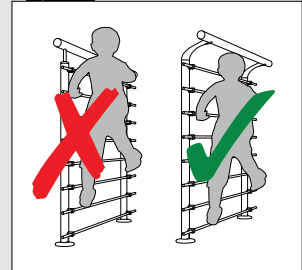

Pour tube plat à tube rond

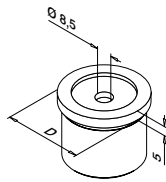
**MOD 0730**

304		Inox brossé	
INDOOR	D		
130730-000	33,7 x 2,0	QS-26 472	2

MOD 0725

304		Inox brossé	
INDOOR	D		
130725-000	42,4 x 2,0	QS-26 472	2

316		Inox brossé	
OUTDOOR			
140725-000	42,4 x 2,0	QS-27 472	2

MOD 0727

304		Inox brossé	
INDOOR	D		
SELL OUT 130727-000	42,4 x 2,6	QS-26 472	2

316		Inox brossé	
OUTDOOR			
SELL OUT 140727-000	42,4 x 2,6	QS-27 472	2

MOD 0726

304		Inox brossé	
INDOOR	D		
130726-000	48,3 x 2,0	QS-26 472	2

MOD 0728

304		Inox brossé	
INDOOR	D		
SELL OUT 130728-000	48,3 x 2,6	QS 26 472	2



Orientables

Pour tube rond

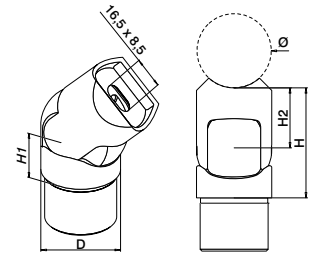

0-70°

**MOD 0776**

304		Inox brossé			
INDOOR	D	Ø	H1 H2 H		
130776-042-12	42,4 x 2,0	42,4	27 35 62	QS-26 472	2

316		Inox brossé			
OUTDOOR					
140776-042-12	42,4 x 2,0	42,4	27 35 62	QS-27 472	2

MOD 0777

304		Inox brossé			
INDOOR	D	Ø	H1 H2 H		
130777-048-12	48,3 x 2,0	48,3	30 38 68	QS-26 472	2

316		Inox brossé			
OUTDOOR					
140777-048-12	48,3 x 2,0	48,3	30 38 68	QS-27 472	2



International Design Modèle Protection

SELL OUT Seulement jusqu'à épuisement des stocks.

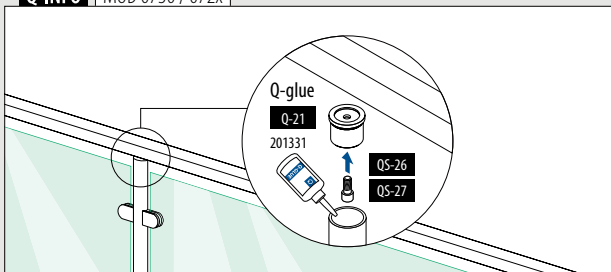
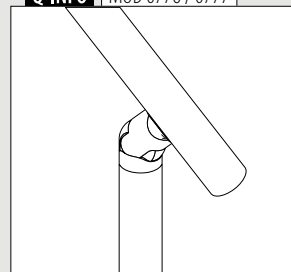
Q-INFO MOD 0730 / 072x**Q-INFO** MOD 0776 / 0777

Pour tube rond

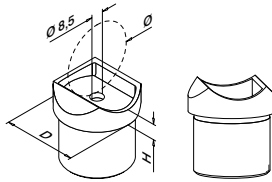
**MOD 0774**

304		Inox brossé			
INDOOR	D	Ø	H		
130774-12	33,7 x 2,0	33,7	8	QS-26	472 2

Compatible avec MOD 0303 raccords

Pour tube rond

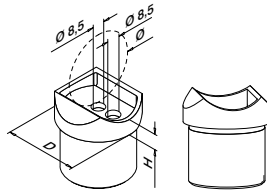
**MOD 0770**

304		Inox brossé			
INDOOR	D	Ø	H		
130770-042-12	42,4 x 2,0	42,4	9	QS-26	472 2
316		Inox brossé			
OUTDOOR	D	Ø	H		
140770-042-12	42,4 x 2,0	42,4	9	QS-27	472 2
316		Poli miroir			
OUTDOOR	D	Ø	H		
140770-042-10	42,4 x 2,0	42,4	9	QS-27	472 2

MOD 0772

304		Inox brossé			
INDOOR	D	Ø	H		
SELL OUT 130772-042-12	42,4 x 2,6	42,4	9	QS-26	472 2
316		Inox brossé			
OUTDOOR	D	Ø	H		
SELL OUT 140772-042-12	42,4 x 2,6	42,4	9	QS-27	472 2

MOD 0771

304		Inox brossé			
INDOOR	D	Ø	H		
130771-048-12	48,3 x 2,0	48,3	11	QS-26	472 2
316		Inox brossé			
OUTDOOR	D	Ø	H		
140771-048-12	48,3 x 2,0	48,3	11	QS-27	472 2

MOD 0773

304		Inox brossé			
INDOOR	D	Ø	H		
130773-048-12	48,3 x 2,6	48,3	11	QS-26	472 2
316		Inox brossé			
OUTDOOR	D	Ø	H		
140773-048-12	48,3 x 2,6	48,3	11	QS-27	472 2



Compatible avec MOD 0303 raccords

Pour tube rond

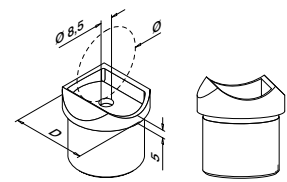
**MOD 0730**

304		Inox brossé			
INDOOR	D	Ø	H		
130730-042	33,7 x 2,0	42,4	8	QS-26	472 2

MOD 0725

304		Inox brossé			
INDOOR	D	Ø	H		
130725-048	42,4 x 2,0	48,3	9	QS-26	472 2
316		Inox brossé			
OUTDOOR	D	Ø	H		
140725-048	42,4 x 2,0	48,3	9	QS-27	472 2

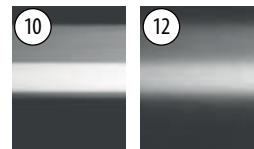

Incompatible avec MOD 0303 raccords

Q-INFO 316

Poli miroir

Inox brossé

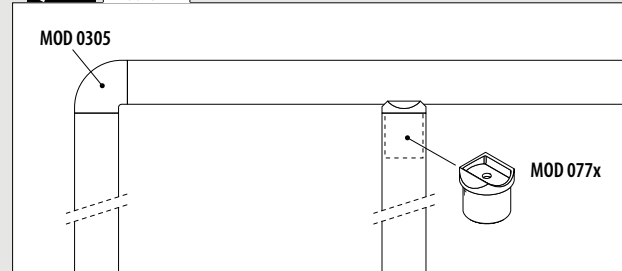
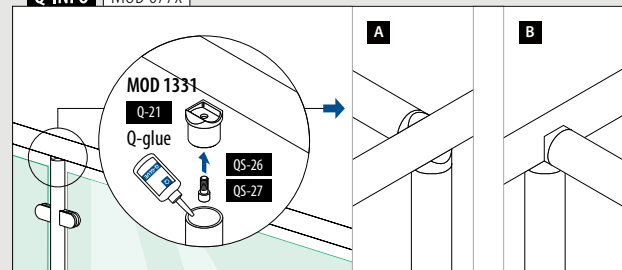
Q-INFO MOD 077x**Q-INFO MOD 077x**

Pour tube plat

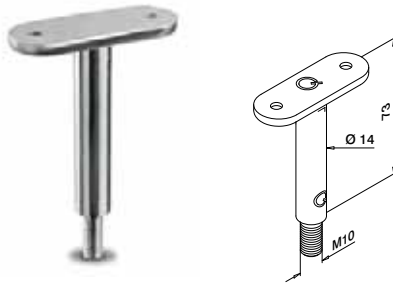

MOD 0810

304 Inox brossé

INDOOR

SELL OUT	130810-000-00	QS-12 472	2



Pour tube rond

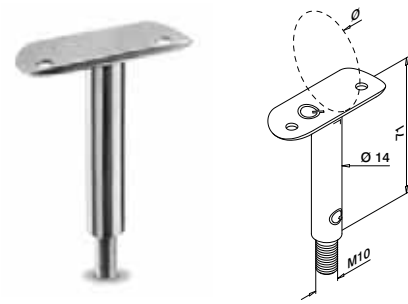

MOD 0810

304 Inox brossé

INDOOR

SELL OUT	130810-042-00	42,4	QS-10 472	2
	130810-048-00	48,3	QS-10 472	2

316 Inox brossé

OUTDOOR

SELL OUT	140810-042-00	42,4	QS-11 472	2
	140810-048-00	48,3	QS-11 472	2



Pour tube plat

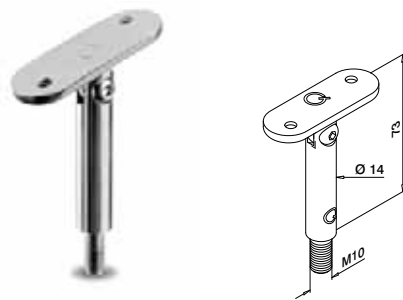

MOD 0818

304 Inox brossé

INDOOR

SELL OUT	130818-000	QS-12 472	2



Pour tube rond

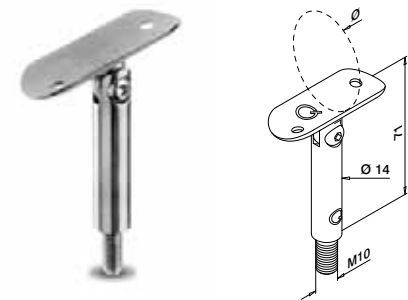

MOD 0818

304 Inox brossé

INDOOR

SELL OUT	130818-042	42,4	QS-10 472	2
	130818-048	48,3	QS-10 472	2

316 Inox brossé

OUTDOOR

SELL OUT	140818-042	42,4	QS-11 472	2
	140818-048	48,3	QS-11 472	2



SELL OUT Seulement jusqu'à épuisement des stocks.

Q-INFO MOD 0810

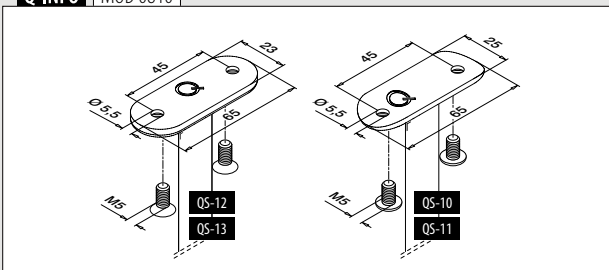

Q-INFO MOD 0818

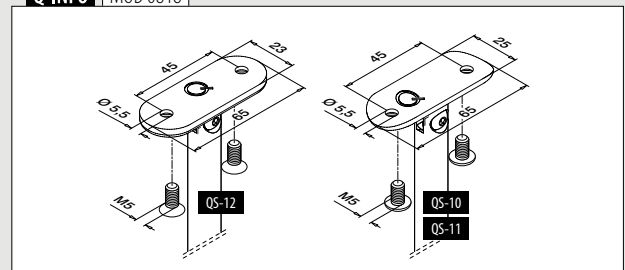

Pour tube rond

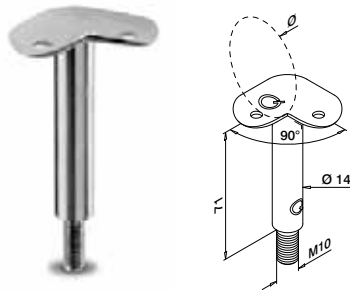

MOD 0810

304		Inox brossé	
INDOOR			
130810-042-90	42,4	QS-10 472	2
130810-048-90	48,3	QS-10 472	2
316		Inox brossé	
OUTDOOR			
140810-042-90	42,4	QS-11 472	2
140810-048-90	48,3	QS-11 472	2

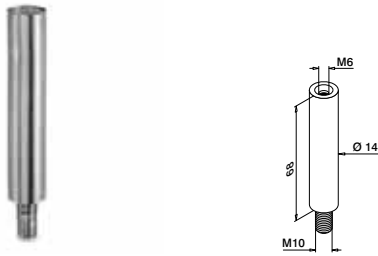

MOD 0811

304		Inox brossé	
INDOOR			
130811	QS-48 472		2
316		Inox brossé	
OUTDOOR			
140811	QS-89 472		2



MOD 4733
296



MOD 0812

304		Inox brossé	
INDOOR			
130812	QS-48 472		2
316		Inox brossé	
OUTDOOR			
140812	QS-89 472		2



Q-INFO MOD 0810-04x-90

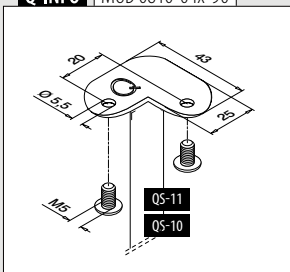

Q-INFO MOD 0811 / 0812

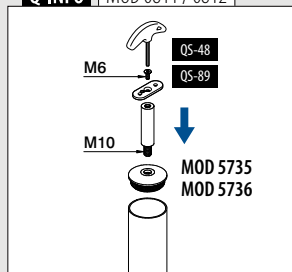

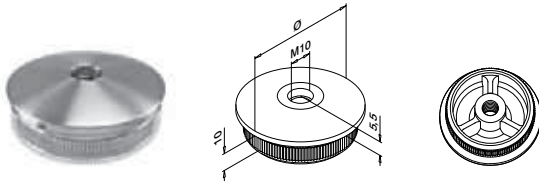

MOD 5735 - EASY HIT®

304 Inox brossé**INDOOR**

	Ø	
135735-242	42,4 x 2,0	2
135735-042	42,4 x 2,6	2
135735-248	48,3 x 2,0	2
135735-048	48,3 x 2,6	2

316 Inox brossé**OUTDOOR**

145735-242	42,4 x 2,0	2
145735-042	42,4 x 2,6	2
145735-248	48,3 x 2,0	2
145735-048	48,3 x 2,6	2
145735-060	60,3 x 2,0	2

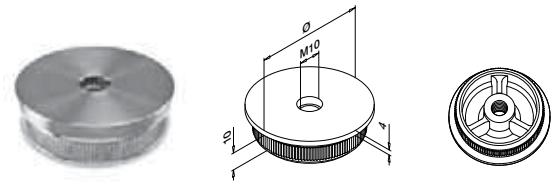

MOD 5736 - EASY HIT®

304 Inox brossé**INDOOR**

	Ø	
135736-242	42,4 x 2,0	2
135736-042	42,4 x 2,6	2
135736-248	48,3 x 2,0	2
135736-048	48,3 x 2,6	2

316 Inox brossé**OUTDOOR**

145736-242	42,4 x 2,0	2
145736-248	48,3 x 2,0	2



Pour tube plat



MOD 3302

316 Inox brossé**OUTDOOR**

143302-000-12	QS-12 472	2
---------------	-----------	---



Pour tube rond



MOD 3302

316 Inox brossé**OUTDOOR**

143302-042-12	42,4	QS-11 472	2
143302-048-12	48,3	QS-11 472	2



Berceaux pour tube

Pour tube plat



MOD 1810

304 Inox brossé			
INDOOR			
131810-000-12	QS-48 472 / QS-10 472		
			8
316 Inox brossé			
OUTDOOR			
141810-000-12	QS-89 472 / QS-11 472		8



Pour tube rond

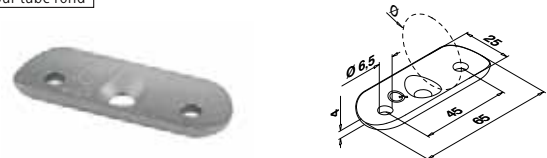

MOD 1810

304 Inox brossé			
INDOOR			
131810-033-12	33,7 QS-48 472 / QS-10 472		
			8
131810-042-12	42,4 QS-48 472 / QS-10 472		8
131810-048-12	48,3 QS-48 472 / QS-10 472		8
316 Inox brossé			
OUTDOOR			
141810-042-12	42,4 QS-89 472 / QS-11 472		8
141810-048-12	48,3 QS-89 472 / QS-11 472		8



Pour tube plat

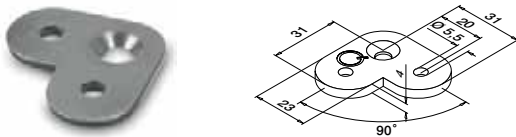

MOD 1802

304 Inox brossé			
INDOOR			
131802-000	QS-48 472 / QS-10 472		
			8



Pour tube rond

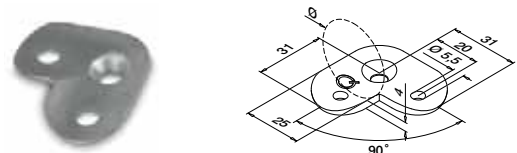

MOD 1802

304 Inox brossé			
INDOOR			
131802-042	42,4 QS-48 472 / QS-10 472		
			8
131802-048	48,3 QS-48 472 / QS-10 472		8



Pour tube plat

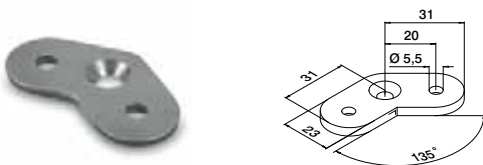

MOD 1801

304 Inox brossé			
INDOOR			
131801-000	QS-48 472 / QS-10 472		
			8



Pour tube rond

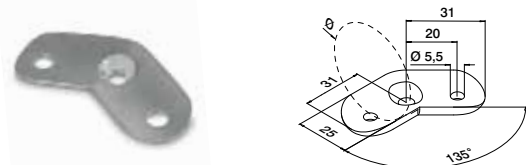

MOD 1801

304 Inox brossé			
INDOOR			
131801-042	42,4 QS-48 472 / QS-10 472		
			8
131801-048	48,3 QS-48 472 / QS-10 472		8

SELL OUT



Pour tube rond

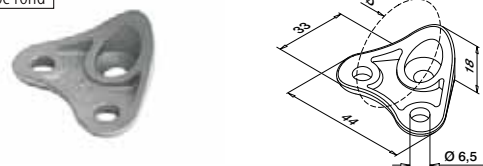

MOD 1820

316 Inox brossé			
OUTDOOR			
141820-042-12	42,4 QS-89 472 / QS-11 472		
			8

Compatible avec MOD 0305 raccords
International Design Modèle Protection

Pour tube plat

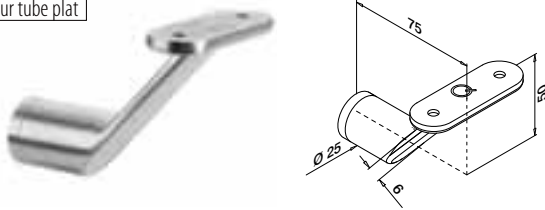

MOD 0123

304	Inox brossé		
INDOOR			
130123-000-12	QS-12 472 / QS-21 472		2
316	Inox brossé		
OUTDOOR			
140123-000-12	QS-13 472 / QS-22 472		2



International Design Modèle Protection

Pour tube plat à tube rond

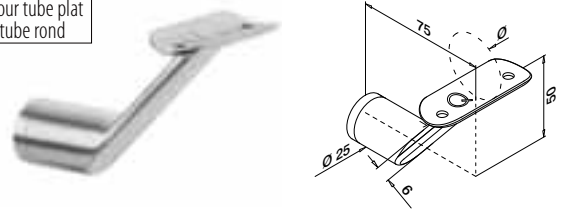

MOD 0123

304	Inox brossé		
INDOOR			
130123-042-12	42,4	QS-10 472 / QS-21 472	2
130123-048-12	48,3	QS-10 472 / QS-21 472	2
316	Inox brossé		
OUTDOOR			
140123-042-12	42,4	QS-11 472 / QS-22 472	2



International Design Modèle Protection

Pour tube rond

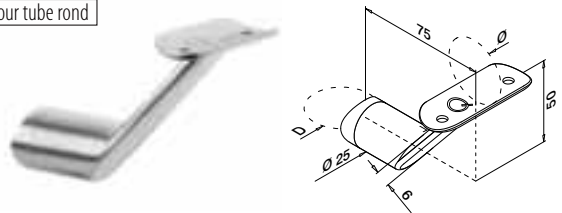

MOD 0124

304	Inox brossé			
INDOOR				
130124-042-12	42,4	42,4	QS-10 472 / QS-21 472	2
316	Inox brossé			
OUTDOOR				
140124-042-12	42,4	42,4	QS-11 472 / QS-22 472	2

MOD 0125

304	Inox brossé			
INDOOR				
130125-042-12	48,3	42,4	QS-10 472 / QS-21 472	2
130125-048-12	48,3	48,3	QS-10 472 / QS-21 472	2
316	Inox brossé			
OUTDOOR				
140125-048-12	48,3	48,3	QS-11 472 / QS-22 472	2



International Design Modèle Protection

Q-INFO

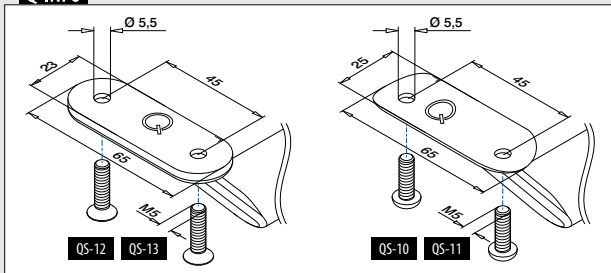

Q-INFO

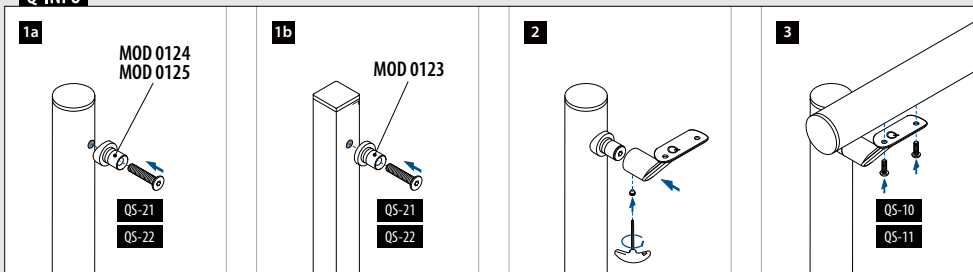

Pour tube plat à tube rond
Hauteur ajustable

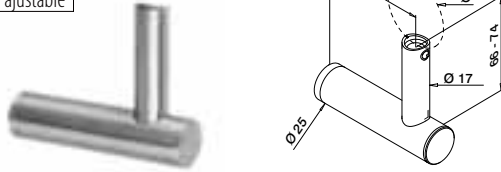

MOD 0147

304 Inox brossé

INDOOR

Ø



SELL OUT	130147-044	42,4 / 48,3	QS-21	472 / QS-25	472	2
----------	------------	-------------	-------	-------------	-----	---

316 Inox brossé

OUTDOOR

SELL OUT	140147-044	42,4 / 48,3	QS-22	472 / QS-71	472	2
----------	------------	-------------	-------	-------------	-----	---



International Design Modèle Protection

Pour tube rond
Hauteur ajustable

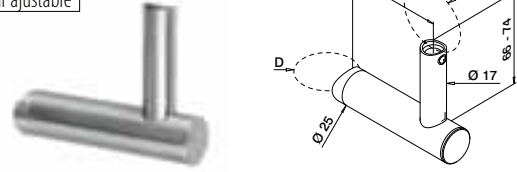

MOD 0143

304 Inox brossé

INDOOR

D Ø



SELL OUT	130143-044-12	42,4	42,4 / 48,3	QS-21	472 / QS-25	472	2
----------	---------------	------	-------------	-------	-------------	-----	---

MOD 0144

304 Inox brossé

INDOOR

D Ø



SELL OUT	130144-044-12	48,3	42,4 / 48,3	QS-21	472 / QS-25	472	2
----------	---------------	------	-------------	-------	-------------	-----	---



International Design Modèle Protection

Pour tube rond

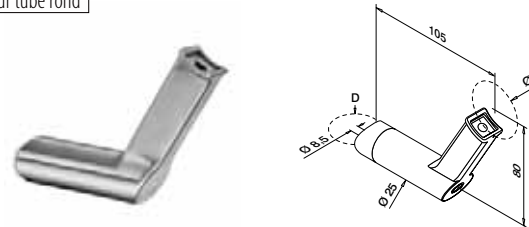

MOD 9330

304 Inox brossé

INDOOR

D Ø



SELL OUT	139330-042	42,4	42,4	QS-21	472 / QS-25	472	2
----------	------------	------	------	-------	-------------	-----	---



SELL OUT Seulement jusqu'à épuisement des stocks.

Q-INFO MOD 0147 / 0143 / 0144

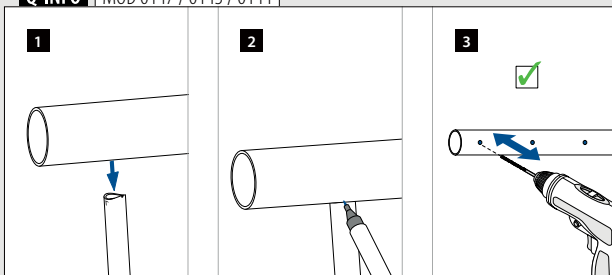

Q-INFO MOD 9330

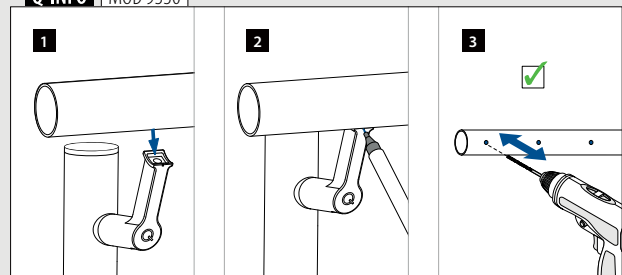

Q-INFO MOD 0147 / 0143 / 0144

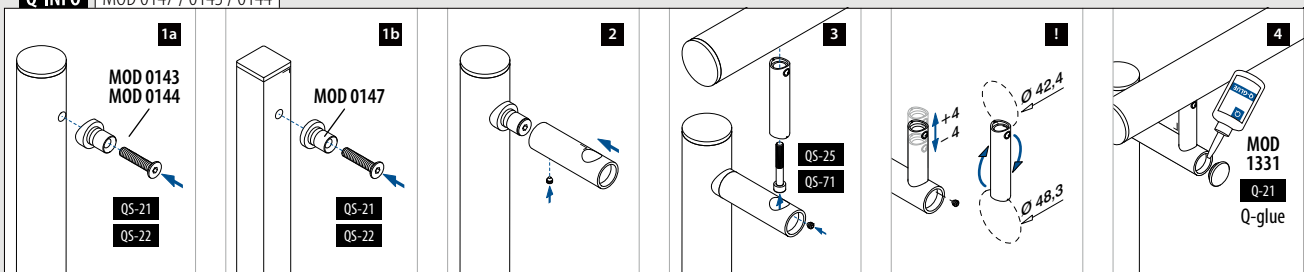

Pour tube plat
Hauteur ajustable

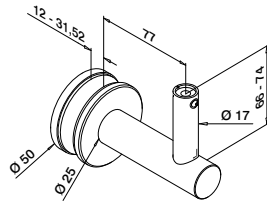

MOD 0148

304 Inox brossé

INDOOR

SELL OUT	130148-000-12	QS-24	472	2
----------	---------------	-------	-----	---



International Design Modèle Protection

Pour tube rond
Hauteur ajustable

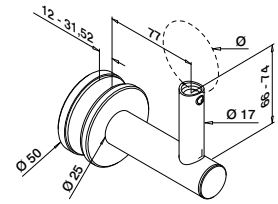

MOD 0148

304 Inox brossé

INDOOR

SELL OUT	130148-044-12	42,4 / 48,3	QS-25	472	2
----------	---------------	-------------	-------	-----	---

316 Inox brossé

OUTDOOR

SELL OUT	140148-044-12	42,4 / 48,3	QS-71	472	2
----------	---------------	-------------	-------	-----	---



International Design Modèle Protection

Pour tube rond

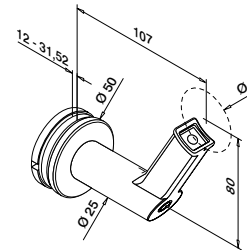

MOD 9350

304 Inox brossé

INDOOR

SELL OUT	139350-042	42,4	QS-25	472	2
SELL OUT	139350-048	48,3	QS-25	472	2

316 Inox brossé

OUTDOOR

SELL OUT	149350-042	42,4	QS-71	472	2
SELL OUT	149350-048	48,3	QS-71	472	2



SELL OUT Seulement jusqu'à épuisement des stocks.

Q-INFO MOD 0148-044

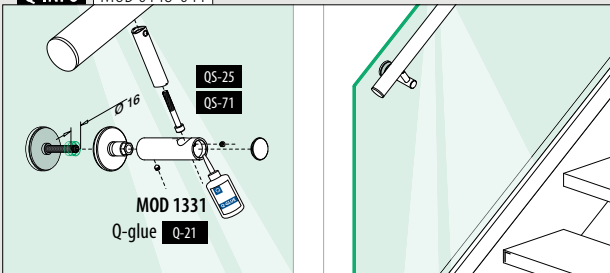

Q-INFO MOD 9350

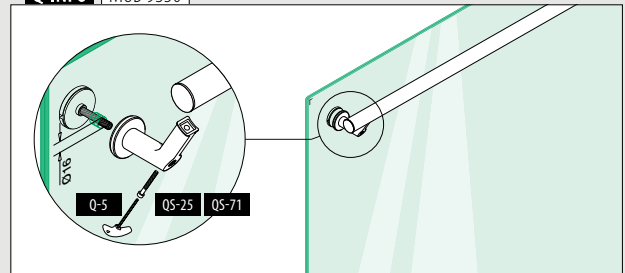

Q-INFO MOD 0148-044

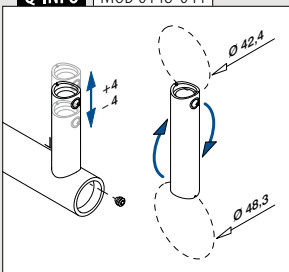

Q-INFO MOD 0148-044

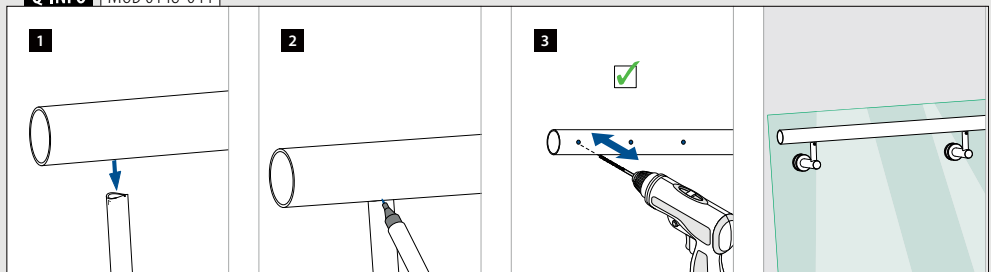

Pour tube plat

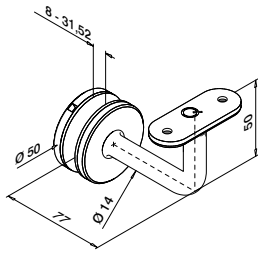

MOD 0117

304	Inox brossé		
INDOOR			
130117-000-12	QS-12 472		2
316	Inox brossé		
OUTDOOR			
140117-000-12	QS-13 472		2



Pour tube rond

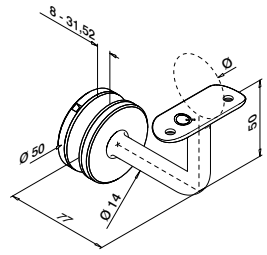

MOD 0117

304	Inox brossé		
INDOOR			
130117-033-12	33,7	QS-10 472	2
130117-042-12	42,4	QS-10 472	2
130117-048-12	48,3	QS-10 472	2
316	Inox brossé		
OUTDOOR			
140117-042-12	42,4	QS-11 472	2
140117-048-12	48,3	QS-11 472	2
316	Poli miroir		
OUTDOOR			
140117-042-10	42,4	QS-11 472	2
140117-048-10	48,3	QS-11 472	2



Pour tube plat

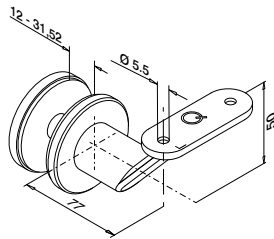

MOD 0129

304	Inox brossé		
INDOOR			
130129-000-12	QS-12 472		2
316	Inox brossé		
OUTDOOR			
140129-000-12	QS-13 472		2



Pour tube rond

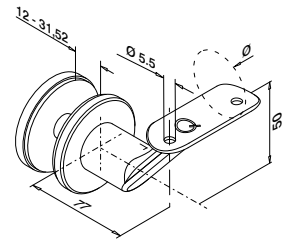

MOD 0129

304	Inox brossé		
INDOOR			
130129-042-12	42,4	QS-10 472	2
130129-048-12	48,3	QS-10 472	2
316	Inox brossé		
OUTDOOR			
140129-042-12	42,4	QS-11 472	2
140129-048-12	48,3	QS-11 472	2



Q-INFO MOD 0117

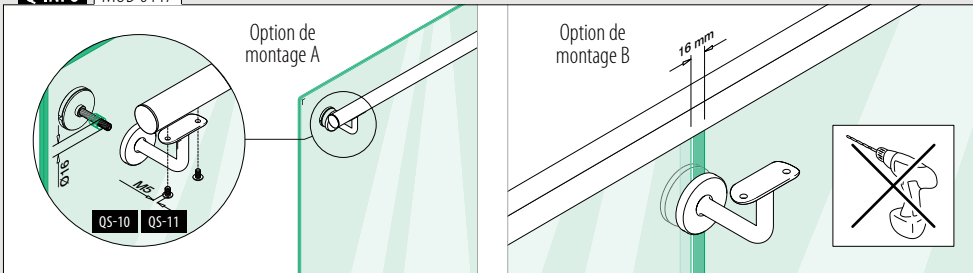

Q-INFO 316

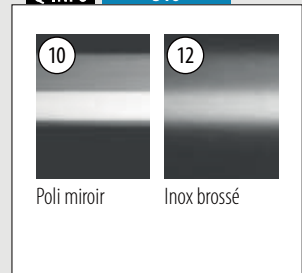

Q-INFO MOD 0129

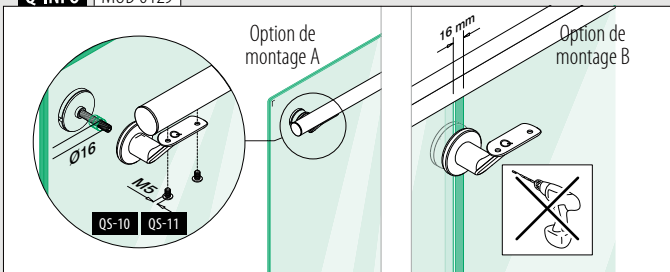

Q-INFO

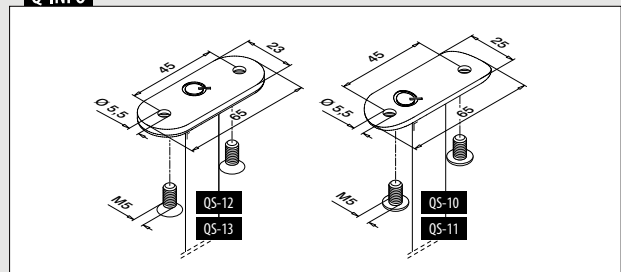

Pour tube plat

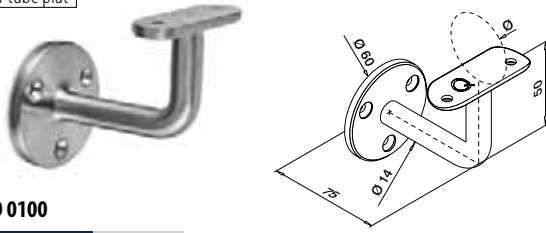

MOD 0100

304	Inox brossé		
INDOOR			
130100-000-12	QS-7 471 / QS-12 472 / QS-87 470	2	
304	Black Line		
INDOOR			
130100-000-82	QS-7 471 / QS-12 472 / QS-87 470	2	
316	Inox brossé		
OUTDOOR			
140100-000-12	QS-50 471 / QS-13 472 / QS-87 470	2	



Pour tube rond

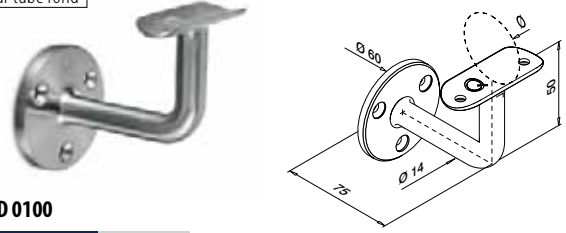

MOD 0100

304	Inox brossé		
INDOOR			
130100-042-12	42,4 QS-7 471 / QS-10 472 / QS-87 470	2	
130100-048-12	48,3 QS-7 471 / QS-10 472 / QS-87 470	2	
316	Inox brossé		
OUTDOOR			
140100-042-12	42,4 QS-50 471 / QS-11 472 / QS-87 470	2	
140100-048-12	48,3 QS-50 471 / QS-11 472 / QS-87 470	2	



Pour tube plat

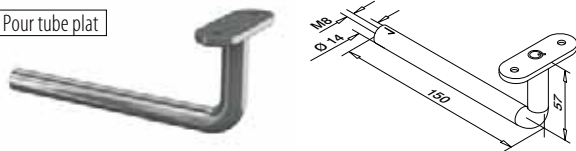

MOD 0809

304	Inox brossé		
INDOOR			
130809-000-12	QS-12 472	2	
316	Inox brossé		
OUTDOOR			
140809-000-12	QS-13 472	2	



Pour tube rond

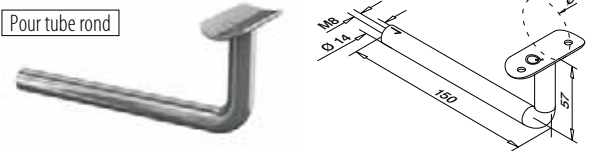

MOD 0809

304	Inox brossé		
INDOOR			
130809-042-12	42,4 QS-10 472	2	
130809-048-12	48,3 QS-10 472	2	
316	Inox brossé		
OUTDOOR			
140809-042-12	42,4 QS-11 472	2	
140809-048-12	48,3 QS-11 472	2	



Platines pour supports de main-courante MOD 0809

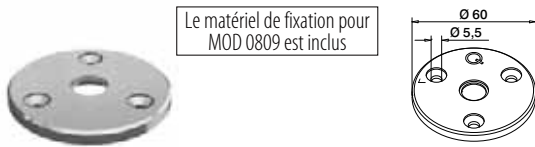

Le matériel de fixation pour MOD 0809 est inclus

MOD 1938

304	Inox brossé		
INDOOR			
131938-12	QS-7 471	2	
316	Inox brossé		
OUTDOOR			
141938-12	QS-50 471	2	

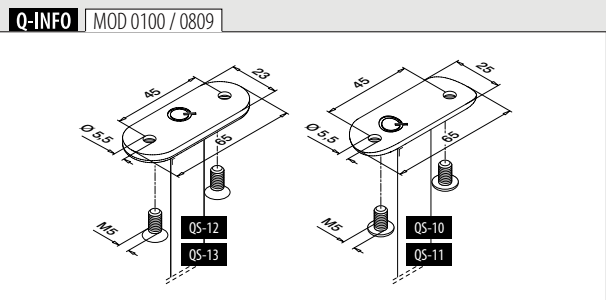
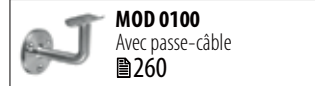

Q-INFO MOD 0809 / 1938

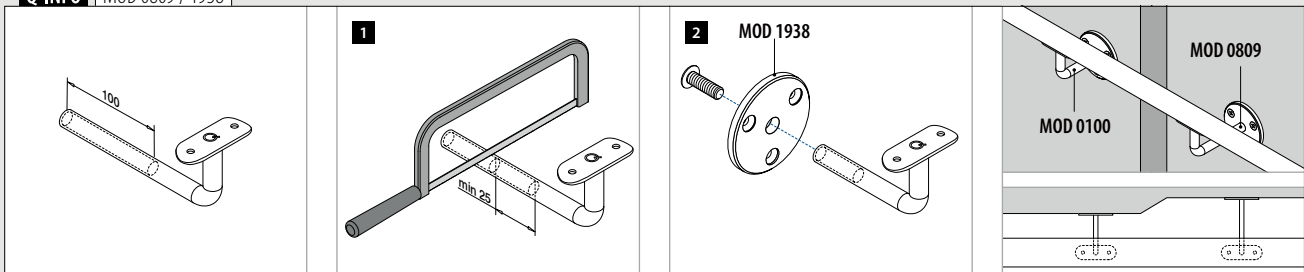

Pour tube plat

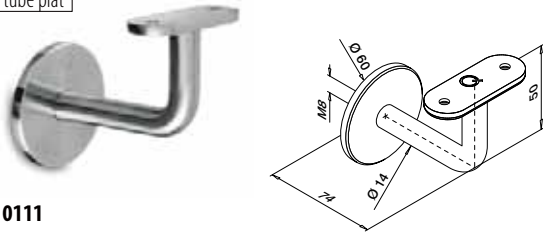

MOD 0111

304	Inox brossé		
INDOOR			
130111-000-12	QS-12	472	2
316	Inox brossé		
OUTDOOR			
140111-000-12	QS-13	472	2



Pour tube rond

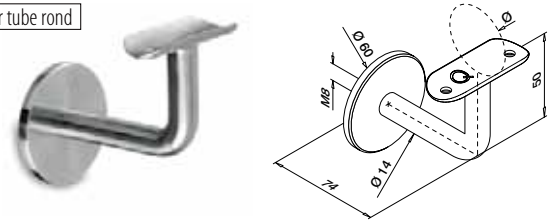

MOD 0111

304	Inox brossé		
INDOOR			
130111-033-12	33,7	QS-10	472 2
130111-042-12	42,4	QS-10	472 2
130111-048-12	48,3	QS-10	472 2
304	Poli miroir		
INDOOR			
SELL OUT	130111-042-10	42,4	QS-10 472 2
304 Black Line			
INDOOR			
NEW	130111-042-82	42,4	QS-10 472 2
316	Inox brossé		
OUTDOOR			
140111-042-12	42,4	QS-11	472 2
140111-048-12	48,3	QS-11	472 2
316	Poli miroir		
OUTDOOR			
140111-042-10	42,4	QS-11	472 2



SELL OUT Seulement jusqu'à épuisement des stocks.

Q-INFO

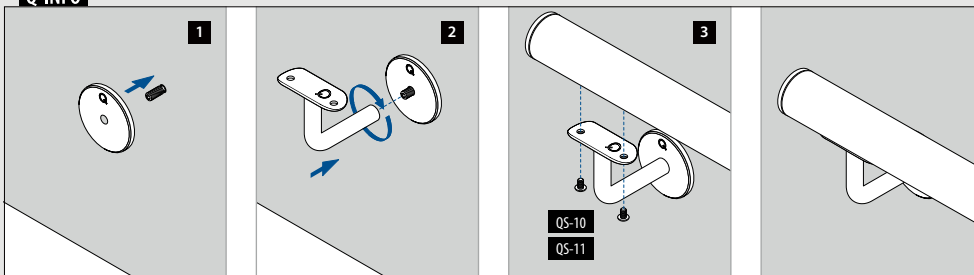

Q-INFO

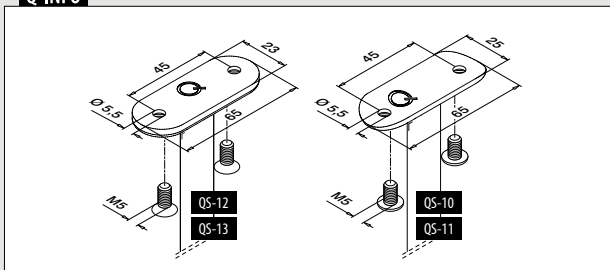

Q-INFO 316 304

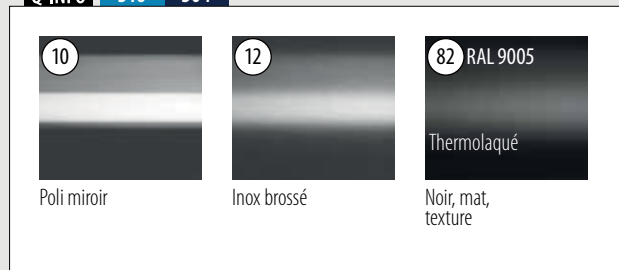

Pour tube rond

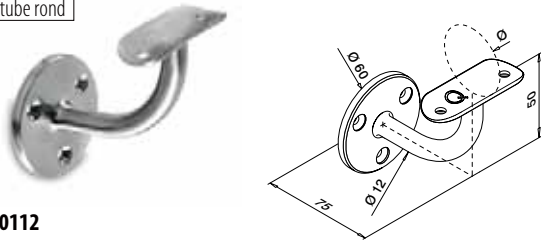
**MOD 0112****304** Inox brossé**INDOOR**

Code	Ø	Accessories	Qty
130112-033-12	33,7	QS-7 471 / QS-10 472 / QS-87 470	2
130112-042-12	42,4	QS-7 471 / QS-10 472 / QS-87 470	2
130112-048-12	48,3	QS-7 471 / QS-10 472 / QS-87 470	2

304 Poli miroir**INDOOR**

Code	Ø	Accessories	Qty
130112-042-10	42,4	QS-7 471 / QS-10 472 / QS-87 470	2

316 Inox brossé**OUTDOOR**

Code	Ø	Accessories	Qty
140112-042-12	42,4	QS-50 471 / QS-11 472 / QS-87 470	2

316 Poli miroir**OUTDOOR**

Code	Ø	Accessories	Qty
140112-042-10	42,4	QS-50 471 / QS-11 472 / QS-87 470	2

Zamak Aspect inox brossé**INDOOR**

Code	Ø	Accessories	Qty
100112-042	42,4	QS-7 471 / QS-10 472 / QS-87 470	2

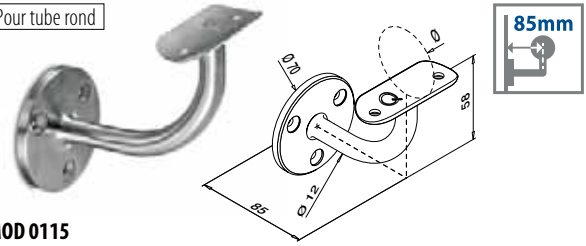

Pour tube rond

**MOD 0115****304** Inox brossé**INDOOR**

Code	Ø	Accessories	Qty
130115	42,4	QS-7 471 / QS-10 472 / QS-87 470	2

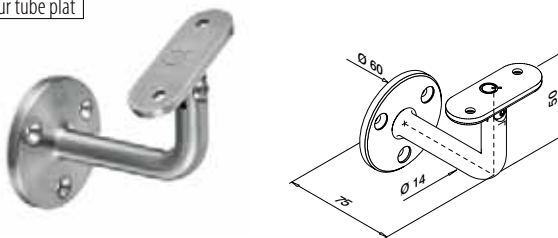

Pour tube plat

**MOD 0102****304** Inox brossé**INDOOR**

Code	Accessories	Qty
130102-000-12	QS-7 471 / QS-12 472 / QS-87 470	2

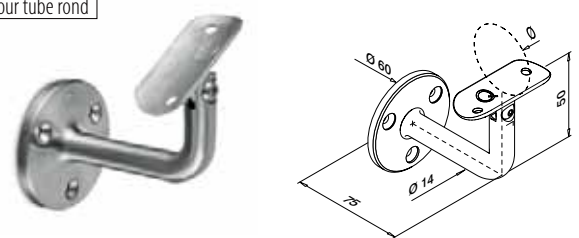

Pour tube rond

**MOD 0102****304** Inox brossé**INDOOR**

Code	Ø	Accessories	Qty
130102-042-12	42,4	QS-7 471 / QS-10 472 / QS-87 470	2
130102-048-12	48,3	QS-7 471 / QS-10 472 / QS-87 470	2

316 Inox brossé**OUTDOOR**

Code	Ø	Accessories	Qty
140102-042-12	42,4	QS-50 471 / QS-11 472 / QS-87 470	2
140102-048-12	48,3	QS-50 471 / QS-11 472 / QS-87 470	2

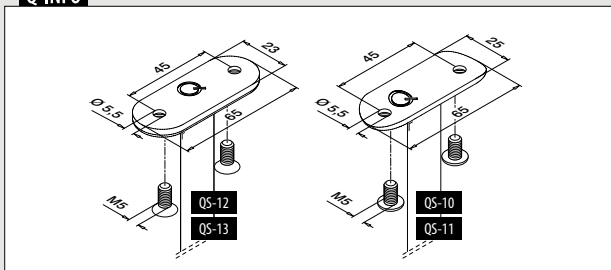
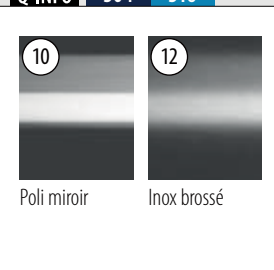
**Q-INFO****Q-INFO** 304 316

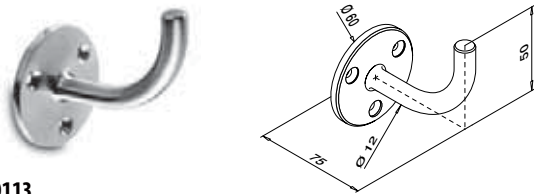

MOD 0113

304	Inox brossé		
INDOOR			
130113	QS-7 471 / QS-87 470		2
316	Inox brossé		
OUTDOOR			
140113	QS-50 471 / QS-87 470		2

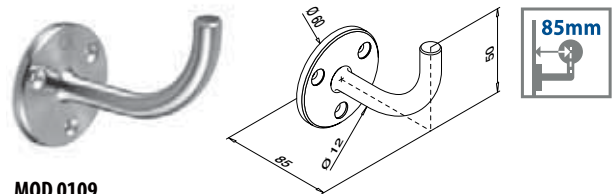

MOD 0109

304	Inox brossé		
INDOOR			
130109	QS-7 471 / QS-87 470		2

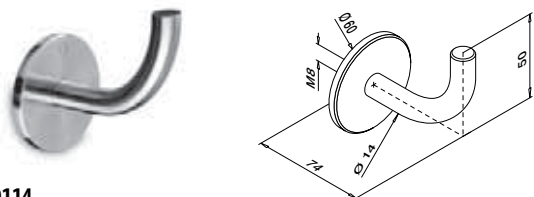

MOD 0114

304	Inox brossé		
INDOOR			
SELL OUT 130114	QS-1 471		2
316	Inox brossé		
OUTDOOR			
SELL OUT 140114	QS-2 471		2

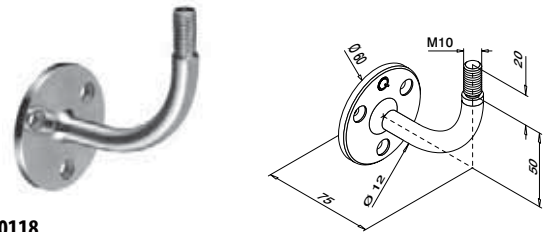

MOD 0118

304	Inox brossé		
INDOOR			
130118	QS-7 471 / QS-87 470		2



MOD 0519

316	Inox brossé		
OUTDOOR			
140519			2
Zamak	Aspect inox brossé		
INDOOR			
SELL OUT 100519			2

SELL OUT Seulement jusqu'à épuisement des stocks.

Q-INFO MOD 0118

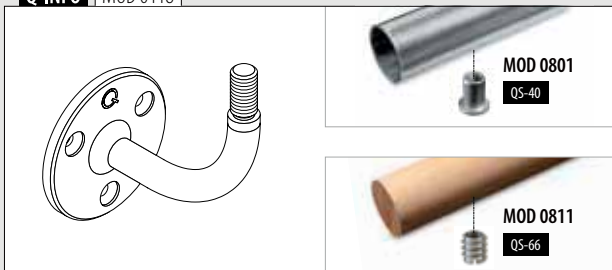

Q-INFO MOD 0519

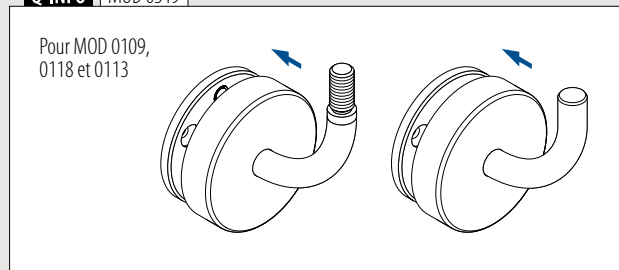

Pour tube plat

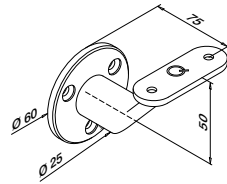

MOD 0126

304 Inox brossé		
INDOOR		
130126-000-12	QS-12 472	2
316 Inox brossé		
OUTDOOR		
140126-000-12	QS-13 472	2



International Design Modèle Protection

Pour tube rond

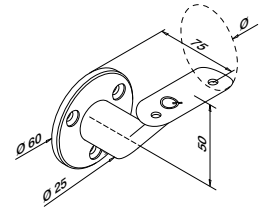

MOD 0126

304 Inox brossé		
INDOOR	Ø	
130126-042-12	42,4	QS-10 472 2
130126-048-12	48,3	QS-10 472 2
316 Inox brossé		
OUTDOOR	Ø	
140126-042-12	42,4	QS-11 472 2



Caches

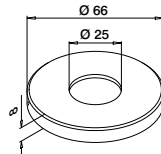

MOD 0520

304 Inox brossé	
INDOOR	
130520-12	2
316 Inox brossé	
OUTDOOR	
140520-12	2

Q-INFO | MOD 0126

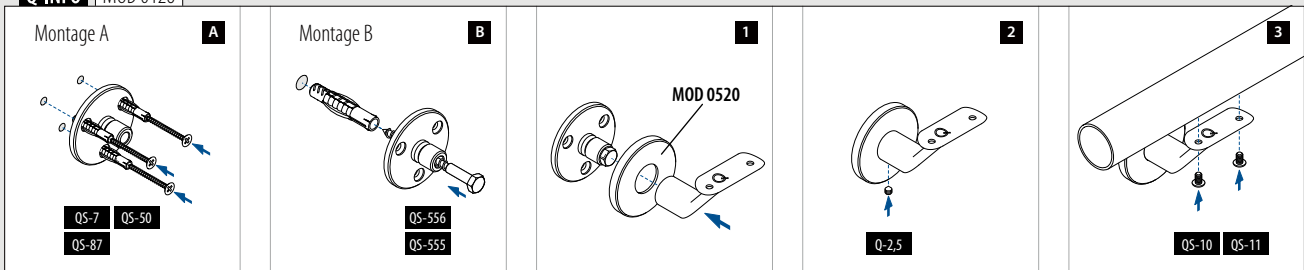

Pour tube rond

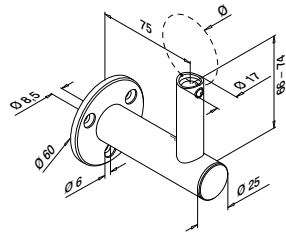

MOD 0142

304 Inox brossé

INDOOR

Ø



SELL OUT	130142-044-12	42,4 / 48,3	QS-25 472	2
----------	---------------	-------------	-----------	---

316 Inox brossé

OUTDOOR

Ø



SELL OUT	140142-044-12	42,4 / 48,3	QS-71 472	2
----------	---------------	-------------	-----------	---



Caches

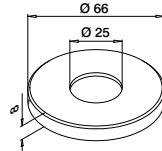

MOD 0520

304 Inox brossé

INDOOR



130520-12	2
-----------	---

316 Inox brossé

OUTDOOR

140520-12	2
-----------	---

Q-INFO MOD 0142

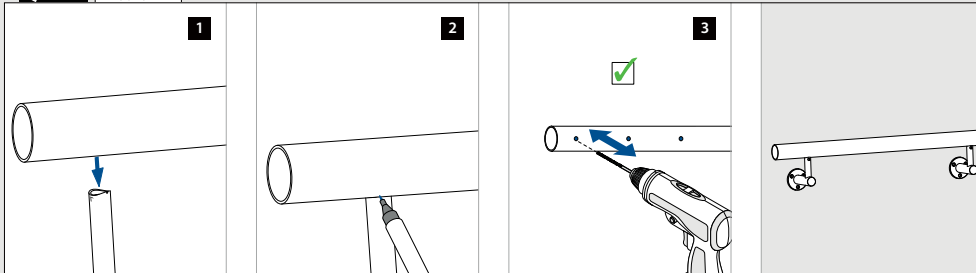

Q-INFO MOD 0520

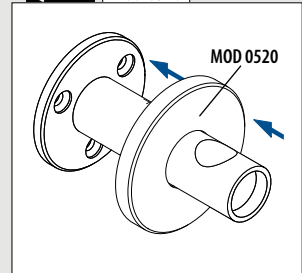

Q-INFO MOD 0142

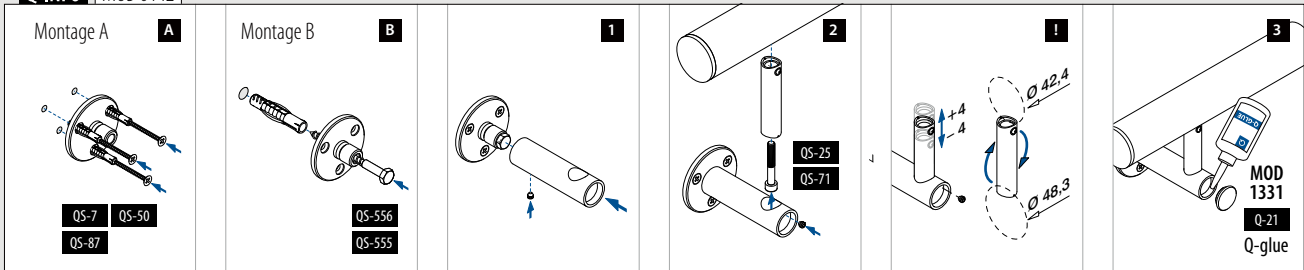

Pour tube rond

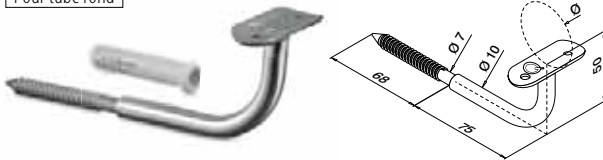

MOD 0110

316	Inox brossé		
OUTDOOR	Ø		
140110	42,4	QS-11 472	2



International Design Modèle Protection

Pour tube rond

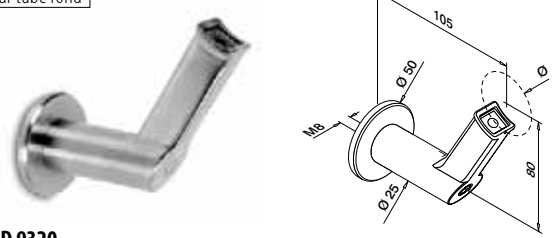

MOD 9320

304	Inox brossé		
INDOOR	Ø		
139320-042	42,4	QS-1 471 / QS-25 472	2



Caches



MOD 0509

316	Inox brossé	
OUTDOOR		
140509		2

International Design Modèle Protection

Q-INFO | MOD 9320

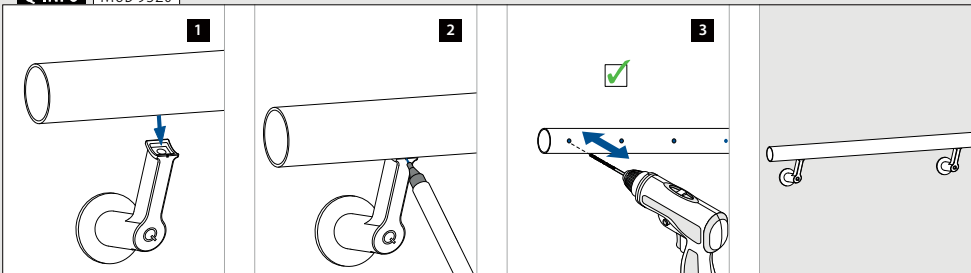

Q-INFO | MOD 0110 / 0509

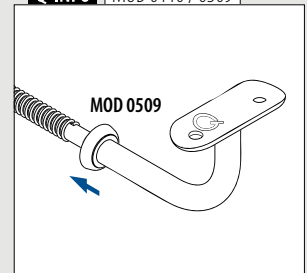

Q-INFO | MOD 9320

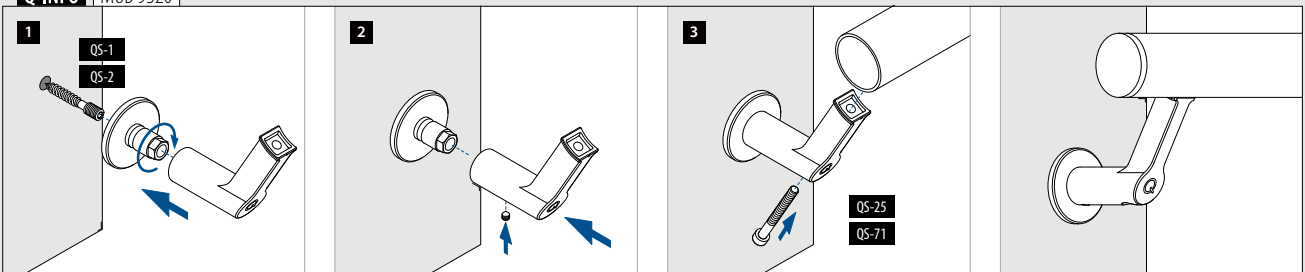

Pour tube plat

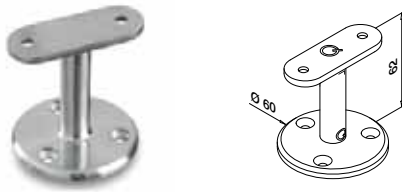

MOD 0708

304		Inox brossé	
INDOOR	Ø		
130708-000-12	QS-5	471 / QS-12	472
			2



Pour tube rond

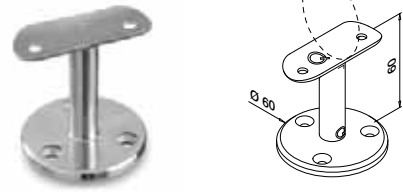

MOD 0708

304		Inox brossé	
INDOOR	Ø		
130708-042-12	42,4	QS-5	471 / QS-10
130708-048-12	48,3	QS-5	471 / QS-10
			472
			2

316		Inox brossé	
OUTDOOR			
140708-042-12	42,4	QS-6	471 / QS-11
140708-048-12	48,3	QS-6	471 / QS-11
			472
			2



Pour tube plat à tube rond

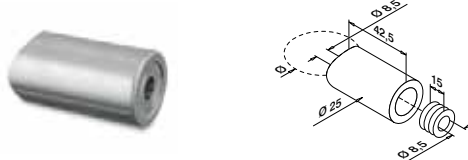

MOD 0625

304		Inox brossé	
INDOOR	Ø		
130625-033-12	33,7	QS-3	471 / QS-29
130625-042-12	42,4	QS-3	471 / QS-29
			472
			4

316		Inox brossé	
OUTDOOR			
140625-042-12	42,4	QS-4	471 / QS-30
			472
			4



Pour tube rond



MOD 0627

304		Inox brossé	
INDOOR	D	Ø	
130627-042-12	42,4	42,4	QS-29
			472
			4



Q-INFO MOD 0708

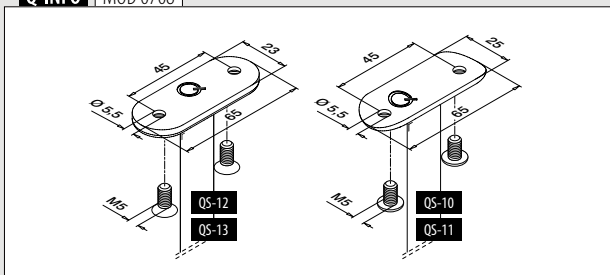

Q-INFO MOD 0625

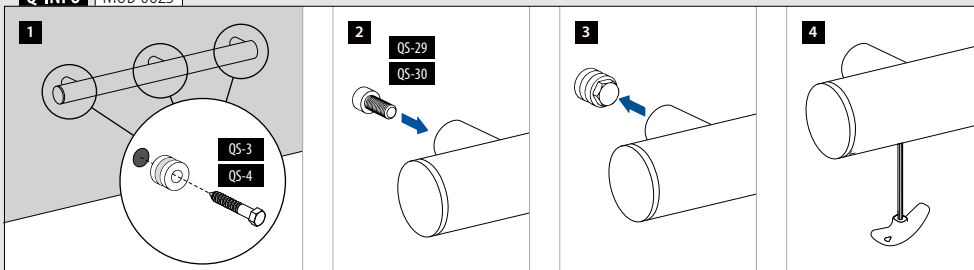

Q-INFO MOD 0627

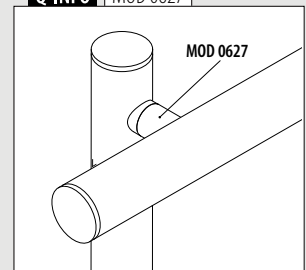



Q-TUBE

TUBES INOX DE Q-RAILING

TOLÉRANCES STRICTES ET FINITION IRRÉPROCHABLE.

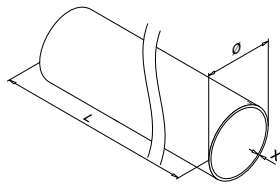
**MOD 0900**

Ø 33,7 mm

304 Inox brossé		
INDOOR		
	X	
130900-233-50-12	2,0	L = 5 m
316 Inox brossé		
OUTDOOR		
140900-233-50-12	2,0	L = 5 m

Ø 42,4 mm

304 Inox brossé		
INDOOR		
	X	
130900-242-25-12	2,0	L = 2,5 m
130900-242-50-12	2,0	L = 5 m
130900-042-50-12	2,6	L = 5 m
304 Poli miroir		
INDOOR		
130900-242-50-10	2,0	L = 5 m
304 Black Line		
INDOOR		
130900-242-50-82	2,0	L = 5 m
316 Inox brossé		
OUTDOOR		
140900-242-25-12	2,0	L = 2,5 m
140900-242-50-12	2,0	L = 5 m
140900-042-50-12	2,6	L = 5 m
316 Poli miroir		
OUTDOOR		
140900-242-50-10	2,0	L = 5 m

Ø 48,3 mm

304 Inox brossé		
INDOOR		
	X	
130900-248-25-12	2,0	L = 2,5 m
130900-248-50-12	2,0	L = 5 m
130900-048-50-12	2,6	L = 5 m
316 Inox brossé		
OUTDOOR		
140900-248-25-12	2,0	L = 2,5 m
140900-248-50-12	2,0	L = 5 m
140900-048-25-12	2,6	L = 2,5 m
140900-048-50-12	2,6	L = 5 m

Ø 60,3 mm

304 Inox brossé		
INDOOR		
	X	
130900-060-50-12	2,0	L = 5 m

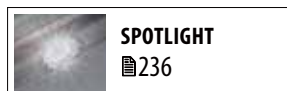

Seulement jusqu'à épuisement des stocks.

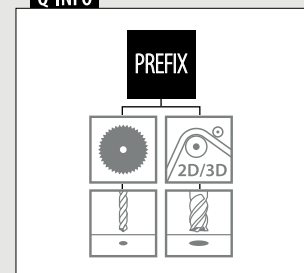
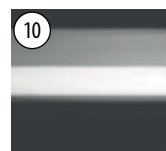
Q-INFO**Q-INFO** 316 304

Poli miroir

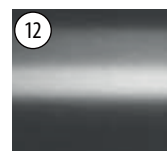

Inox brossé



Noir, mat, texture

Q-INFO**Gain de temps et d'argent avec Q-tube**

Le degré de tolérance réduit ainsi que le cordon racle de la soudure de nos tubes permettent un parfait emboîtement et garantissent ainsi efficacité et rapidité d'installation. Dans un souci de qualité tous nos tubes sont conditionnés et emballés séparément.

Raccords



MOD 5792 - EASY HIT®

304 Brut			
INDOOR		Pour tube Ø	
SELL OUT	135792-242	42,4 x 2,0	2
SELL OUT	135792-042	42,4 x 2,6	2
SELL OUT	135792-248	48,3 x 2,0	2
316 Brut			
OUTDOOR			
	145792-233	33,7 x 2,0	2
	145792-242	42,4 x 2,0	2
SELL OUT	145792-042	42,4 x 2,6	2
	145792-248	48,3 x 2,0	2
	145792-048	48,3 x 2,6	2



International Design Modèle Protection



MOD 0790

304 Inox brossé			
INDOOR		Pour tube Ø	
	130790-233-12	33,7 x 2,0	2
	130790-242-12	42,4 x 2,0	2
SELL OUT	130790-042-12	42,4 x 2,6	2
	130790-248-12	48,3 x 2,0	2
	130790-048-12	48,3 x 2,6	2
316 Inox brossé			
OUTDOOR			
	140790-242-12	42,4 x 2,0	2
SELL OUT	140790-042-12	42,4 x 2,6	2
	140790-248-12	48,3 x 2,0	2



Cintres



MOD 0903

304 Inox brossé			
INDOOR		Ø	R
	130903-242-12	42,4 x 2,0	85
	130903-248-12	48,3 x 2,0	97

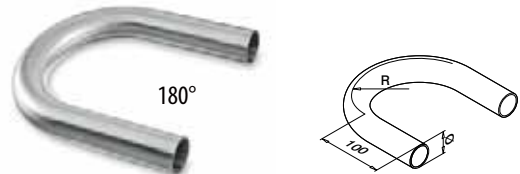

MOD 0906

304 Inox brossé			
INDOOR		Ø	R
	130906-242-12	42,4 x 2,0	85
	130906-248-12	48,3 x 2,0	97
316 Inox brossé			
OUTDOOR			
	140906-242-12	42,4 x 2,0	85
	140906-248-12	48,3 x 2,0	97

Q-INFO MOD 5792

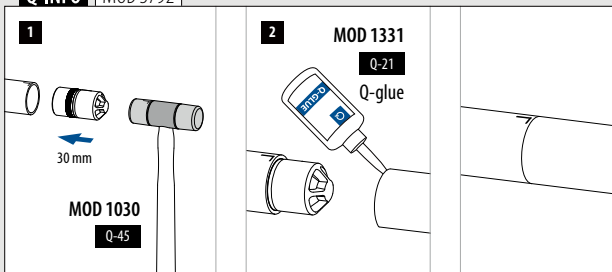

SELL OUT Seulement jusqu'à épuisement des stocks.

Raccords

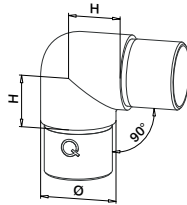

MOD 0303

304 Inox brossé

INDOOR	Pour tube Ø	H	
130303-233-12	33,7 x 2,0	25	2
130303-242-12	42,4 x 2,0	30	2
SELL OUT 130303-042-12	42,4 x 2,6	30	2
130303-248-12	48,3 x 2,0	35	2
130303-048-12	48,3 x 2,6	35	2
SELL OUT 130303-060-12	60,3 x 2,0	40	2

316 Inox brossé

OUTDOOR

140303-242-12	42,4 x 2,0	30	2
SELL OUT 140303-042-12	42,4 x 2,6	30	2
140303-248-12	48,3 x 2,0	35	2
140303-048-12	48,3 x 2,6	35	2

316 Poli miroir

OUTDOOR

140303-242-10	42,4 x 2,0	30	2
---------------	------------	----	---



Compatible avec 90° MOD 0710, 0810 et 4710 supports de main-courante

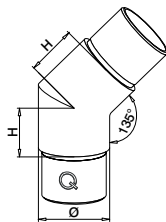

MOD 0300

304 Inox brossé

INDOOR	Pour tube Ø	H	
130300-242-12	42,4 x 2,0	30	2
SELL OUT 130300-042-12	42,4 x 2,6	30	2
SELL OUT 130300-248-12	48,3 x 2,0	35	2

316 Inox brossé

OUTDOOR

140300-242-12	42,4 x 2,0	30	2
140300-248-12	48,3 x 2,0	35	2

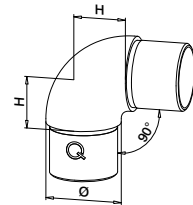

MOD 0305

304 Inox brossé

INDOOR	Pour tube Ø	H	
130305-233-12	33,7 x 2,0	25	2
130305-242-12	42,4 x 2,0	30	2
130305-248-12	48,3 x 2,0	35	2

316 Inox brossé

OUTDOOR

140305-242-12	42,4 x 2,0	30	2
SELL OUT 140305-042-12	42,4 x 2,6	30	2
140305-248-12	48,3 x 2,0	35	2
140305-048-12	48,3 x 2,6	35	2

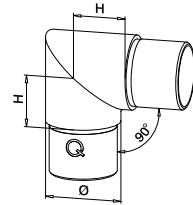
Compatible avec MOD 1820 berceaux pour tube
Incompatible avec MOD 0710, 0810 et 4710 supports de main-courante

MOD 0301

304 Inox brossé

INDOOR	Pour tube Ø	H	
SELL OUT 130301-233-12	33,7 x 2,0	25	2
SELL OUT 130301-242-12	42,4 x 2,0	30	2

316 Inox brossé

OUTDOOR

SELL OUT 140301-242-12	42,4 x 2,0	30	2
SELL OUT 140301-248-12	48,3 x 2,0	35	2



Incompatible avec 90° MOD 0710, 0810 et 4710 supports de main-courante

**MOD 1820**
337**MOD 0710**
325**MOD 0810**
335**MOD 4710**
294

Q-INFO | 304 | 316

10

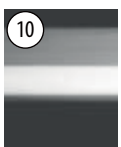

Poli miroir

12

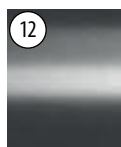

Inox brossé

Raccords

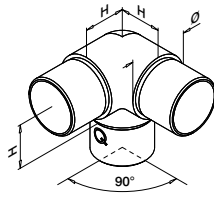

MOD 0304

304 Inox brossé

INDOOR	Pour tube Ø	H	
130304-233-12	33,7 x 2,0	25	2
130304-242-12	42,4 x 2,0	30	2
130304-248-12	48,3 x 2,0	35	2

316 Inox brossé

OUTDOOR

140304-242-12	42,4 x 2,0	30	2
140304-042-12	42,4 x 2,6	30	2
140304-248-12	48,3 x 2,0	35	2
140304-048-12	48,3 x 2,6	35	2

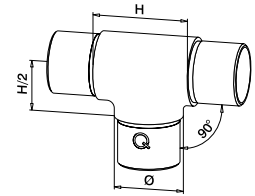

MOD 0307

304 Inox brossé

INDOOR	Pour tube Ø	H	H/2	
130307-233-12	33,7 x 2,0	50	25	2
130307-242-12	42,4 x 2,0	60	30	2
130307-248-12	48,3 x 2,0	70	35	2

316 Inox brossé

OUTDOOR

140307-242-12	42,4 x 2,0	60	30	2
140307-248-12	48,3 x 2,0	70	35	2
140307-048-12	48,3 x 2,6	70	35	2

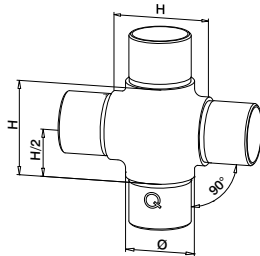

MOD 0309

304 Inox brossé

INDOOR	Pour tube Ø	H	H/2	
130309-242-12	42,4 x 2,0	60	30	2

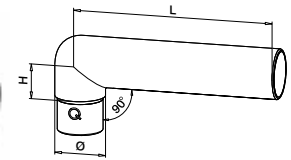

MOD 0306

304 Inox brossé

INDOOR	Pour tube Ø	H	L	
130306-233	33,7 x 2,0	25	223	2
130306-242	42,4 x 2,0	30	228	2



Q-INFO MOD 0306

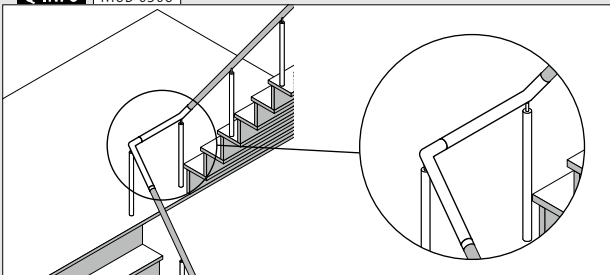

Q-INFO

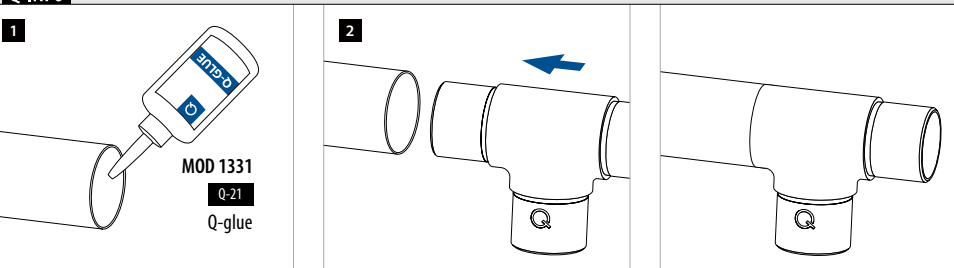

Seulement jusqu'à épuisement des stocks.

Haut : départ à droite
Bas : départ m-c rampant

**MOD 0317**

304		Inox brossé			
INDOOR	Pour tube Ø	H1	H2	H3	
130317-242-01	42,4 x 2,0	27	60	30	2
130317-248-01	48,3 x 2,0	30	65	35	2

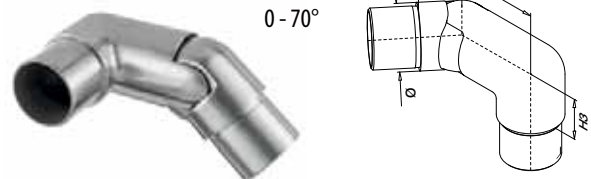

Haut : départ à gauche
Bas : départ m-c rampant

**MOD 0317**

304		Inox brossé			
INDOOR	Pour tube Ø	H1	H2	H3	
130317-242-02	42,4 x 2,0	27	60	30	2
130317-248-02	48,3 x 2,0	30	65	35	2

**MOD 0791**

304		Inox brossé	
INDOOR	Pour tube Ø	H	
130791-242-12	42,4 x 2,0	30	2
130791-248-12	48,3 x 2,0	35	2

316		Inox brossé	
OUTDOOR	Pour tube Ø	H	
140791-242-12	42,4 x 2,0	30	2

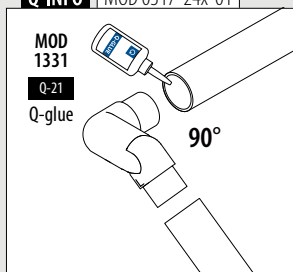
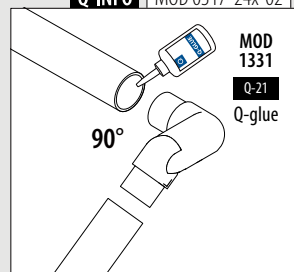
**Q-INFO** MOD 0317-24x-01**Q-INFO** MOD 0317-24x-02

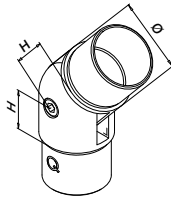

-90°
+90°

**MOD 0302****304**

Inox brossé

INDOOR	Pour tube Ø	H	
130302-233-12	33,7 x 2,0	22	2
130302-242-12	42,4 x 2,0	27	2
130302-248-12	48,3 x 2,0	30	2

316

Inox brossé

OUTDOOR	Pour tube Ø	H	
140302-233-12	33,7 x 2,0	27	2
140302-242-12	42,4 x 2,0	27	2
140302-248-12	48,3 x 2,0	30	2

SELL OUT

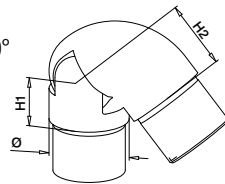

40 - 70°

**MOD 0312****304**

Inox brossé

INDOOR	Pour tube Ø	H	
130312-233-12	33,7 x 2,0	22	2
130312-242-12	42,4 x 2,0	27	2
130312-042-12	42,4 x 2,6	27	2
130312-248-12	48,3 x 2,0	30	2
130312-048-12	48,3 x 2,6	30	2
130312-048-12	48,3 x 2,6	30	2

316

Inox brossé

OUTDOOR	Pour tube Ø	H	
140312-233-12	33,7 x 2,0	27	2
140312-242-12	42,4 x 2,0	27	2
140312-042-12	42,4 x 2,6	27	2
140312-248-12	48,3 x 2,0	30	2
140312-048-12	48,3 x 2,6	30	2
140312-048-12	48,3 x 2,6	30	2
140312-060-12	60,3 x 2,0	33	2

SELL OUT

SELL OUT

SELL OUT

**MOD 0312****304**

Inox brossé

INDOOR	Pour tube Ø	H	
130312-233-12	33,7 x 2,0	22	2
130312-242-12	42,4 x 2,0	27	2
130312-042-12	42,4 x 2,6	27	2
130312-248-12	48,3 x 2,0	30	2
130312-048-12	48,3 x 2,6	30	2

316

Inox brossé

OUTDOOR	Pour tube Ø	H	
140312-242-12	42,4 x 2,0	27	2
140312-042-12	42,4 x 2,6	27	2
140312-248-12	48,3 x 2,0	30	2
140312-048-12	48,3 x 2,6	30	2
140312-060-12	60,3 x 2,0	33	2

316

Poli miroir

OUTDOOR	Pour tube Ø	H	
140312-242-10	42,4 x 2,0	27	2

International Design Modèle Protection



International Design Modèle Protection

SELL OUT

Seulement jusqu'à épuisement des stocks.

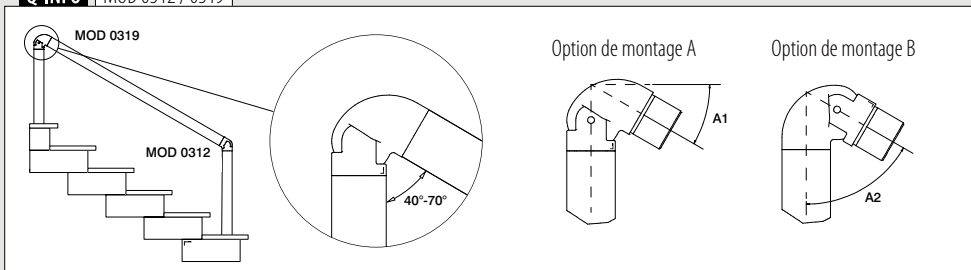
Q-INFO | MOD 0312 / 0319**Q-INFO** | 304 | 316

10



Poli miroir

12

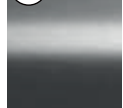

Inox brossé

Embouts

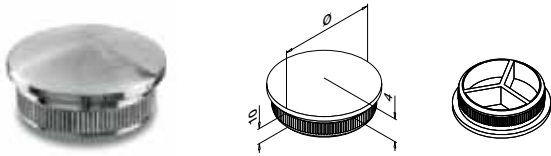

MOD 5729 - EASY HIT®

304		Inox brossé	
INDOOR	Pour tube Ø		
135729-233-12	33,7 x 2,0		2
135729-242-12	42,4 x 2,0		2
SELL OUT 135729-042-12	42,4 x 2,6		2
135729-248-12	48,3 x 2,0		2
135729-048-12	48,3 x 2,6		2
SELL OUT 135729-060-12	60,3 x 2,0		2

316		Inox brossé	
OUTDOOR			
145729-233-12	33,7 x 2,0		2
145729-242-12	42,4 x 2,0		2
SELL OUT 145729-042-12	42,4 x 2,6		2
145729-248-12	48,3 x 2,0		2
145729-048-12	48,3 x 2,6		2

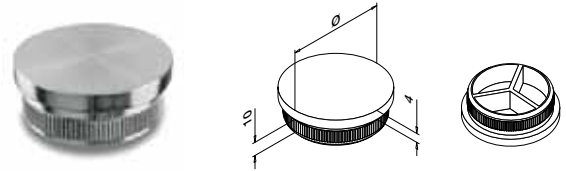

MOD 5732 - EASY HIT®

304		Inox brossé	
INDOOR	Pour tube Ø		
135732-233-12	33,7 x 2,0		2
135732-242-12	42,4 x 2,0		2
SELL OUT 135732-042-12	42,4 x 2,6		2
135732-248-12	48,3 x 2,0		2
135732-048-12	48,3 x 2,6		2

304		Black Line	
INDOOR			
NEW 135732-242-82	42,4 x 2,0		2

316		Inox brossé	
OUTDOOR			
145732-233-12	33,7 x 2,0		2
145732-242-12	42,4 x 2,0		2
SELL OUT 145732-042-12	42,4 x 2,6		2
145732-248-12	48,3 x 2,0		2
145732-048-12	48,3 x 2,6		2

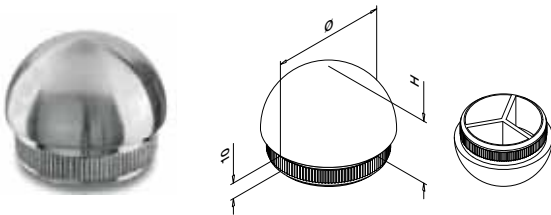

MOD 5730 - EASY HIT®

304		Inox brossé	
INDOOR	Pour tube Ø	H	
135730-233-12	33,7 x 2,0	17	2
135730-242-12	42,4 x 2,0	21	2
SELL OUT 135730-042-12	42,4 x 2,6	21	2
SELL OUT 135730-248-12	48,3 x 2,0	24	2

316		Inox brossé	
OUTDOOR			
145730-242-12	42,4 x 2,0	21	2

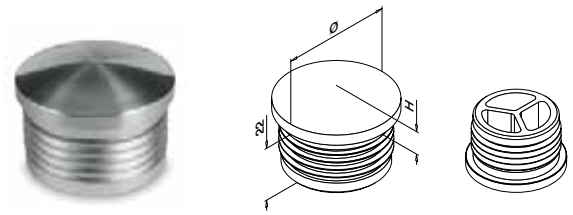

MOD 5729 - EASY HIT®

Plastique		Aspect inox brossé	
INDOOR	Pour tube Ø	H	
155729-233	33,7 x 2,0	8	2
155729-242	42,4 x 2,0	9	2
155729-248	48,3 x 2,0	9	2



MOD 0729

304		Inox brossé	
INDOOR	Pour tube Ø	H	
SELL OUT 130729-242-10	42,4 x 2,0	9	2

316		Poli miroir	
OUTDOOR			
140729-242-10	42,4 x 2,0	9	2



Q-INFO | MOD 5729 / 5730 / 5732

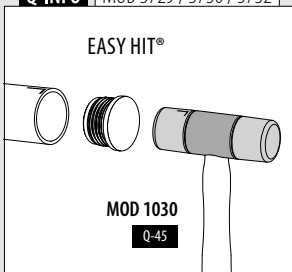

Q-INFO | MOD 0729

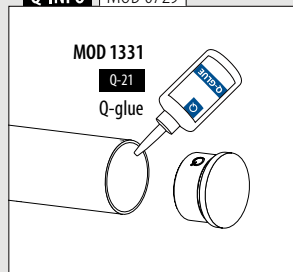

Embouts crosses

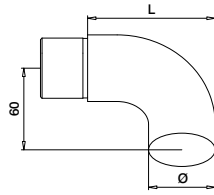

MOD 0739

304 Inox brossé

INDOOR	Pour tube Ø	L	
130739-233-12	33,7 x 2,0	77	2
130739-242-12	42,4 x 2,0	81	2
SELL OUT 130739-042-12	42,4 x 2,6	81	2
130739-248-12	48,3 x 2,0	84	2
130739-048-12	48,3 x 2,6	84	2

316 Inox brossé

OUTDOOR

140739-242-12	42,4 x 2,0	81	2
SELL OUT 140739-042-12	42,4 x 2,6	81	2
140739-248-12	48,3 x 2,0	84	2
140739-048-12	48,3 x 2,6	84	2



Pour escaliers

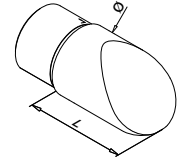

MOD 0738

304 Inox brossé

INDOOR	Pour tube Ø	L	
130738-242-12	42,4 x 2,0	60	2
130738-248-12	48,3 x 2,0	65	2

316 Inox brossé

OUTDOOR

140738-242-12	42,4 x 2,0	60	2
---------------	------------	----	---



International Design Modèle Protection

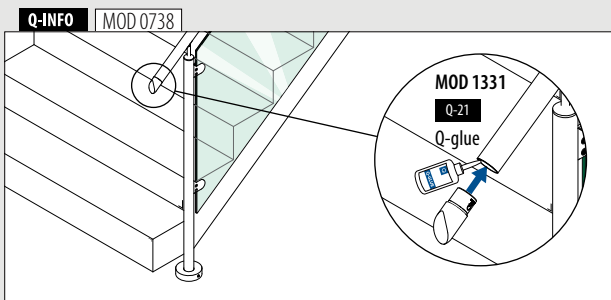

SELL OUT Seulement jusqu'à épuisement des stocks.

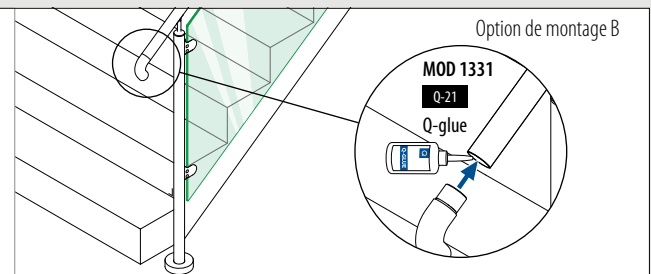
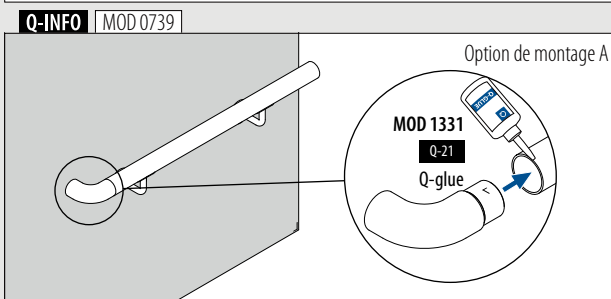

Embases murales pour tube

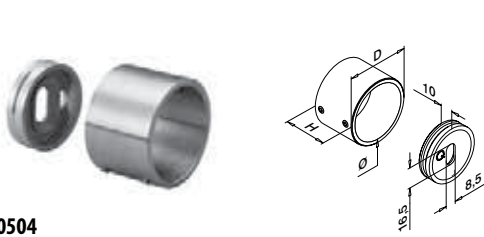

MOD 0504

304		Inox brossé					
INDOOR	Ø	D	H				
130504-033-12	33,7	41	30	QS-55	470 / QS-21	472	2
130504-042-12	42,4	50	35	QS-55	470 / QS-21	472	2
130504-048-12	48,3	56	35	QS-55	470 / QS-21	472	2

316		Inox brossé					
OUTDOOR	Ø	D	H				
140504-033-12	33,7	41	30	QS-55	470 / QS-22	472	2
140504-042-12	42,4	50	35	QS-55	470 / QS-22	472	2
140504-048-12	48,3	56	35	QS-55	470 / QS-22	472	2

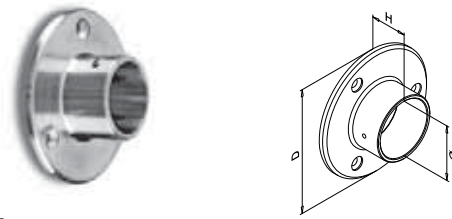

MOD 0505

304		Inox brossé					
INDOOR	Pour tube Ø	D	H				
130505-033-12	33,7	85	30	QS-7	471	471	2
130505-042-12	42,4	95	30	QS-7	471	471	2
130505-048-12	48,3	100	35	QS-7	471	471	2
130505-060-12	60,3	115	40	QS-7	471	471	2

316		Inox brossé					
OUTDOOR	Ø	D	H				
140505-033-12	33,7	85	30	QS-50	471	471	2
140505-042-12	42,4	95	30	QS-50	471	471	2
140505-048-12	48,3	100	35	QS-50	471	471	2

316		Poli miroir					
OUTDOOR	Ø	D	H				
140505-042-10	42,4	95	30	QS-50	471	471	2

SELL OUT

NEW



Embases murales pour tube

Orientables

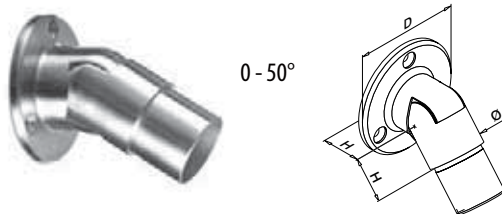

MOD 0506

304		Inox brossé					
INDOOR	Pour tube Ø	D	H				
130506-033-12	33,7 x 2,0	70	26	QS-7	471	471	2
130506-042-12	42,4 x 2,0	75	30	QS-7	471	471	2
130506-048-12	48,3 x 2,0	80	33	QS-7	471	471	2

316		Inox brossé					
OUTDOOR	Ø	D	H				
140506-033-12	33,7 x 2,0	70	26	QS-50	471	471	2
140506-042-12	42,4 x 2,0	75	30	QS-50	471	471	2

SELL OUT

SELL OUT

NEW

NEW



International Design Modèle Protection

Q-INFO 304 316

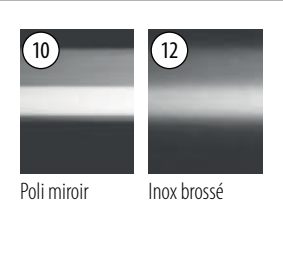

Q-INFO MOD 0504

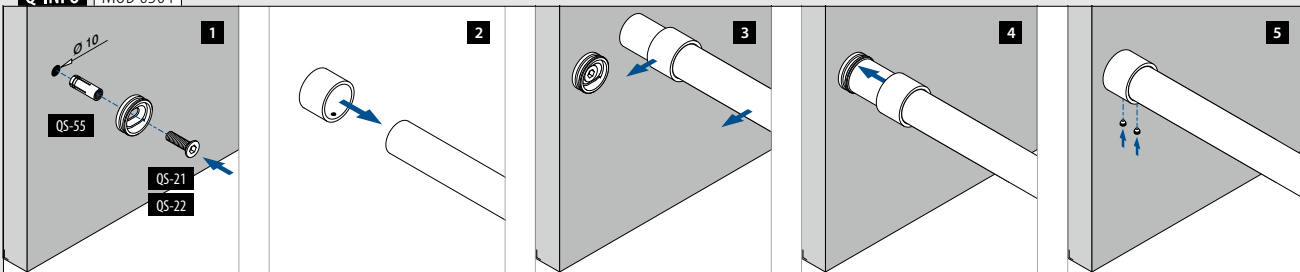



Retrouvez toutes les informations sur
Barrier Line en ligne :



[https://q-ne.ws/
BarrierLine23](https://q-ne.ws/BarrierLine23)



BARRIER LINE

Barrière de protection

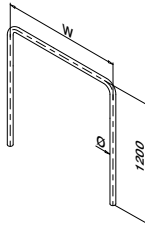

MOD 0090

316		Inox brossé		
OUTDOOR	W	Ø		
140090-248-09-12	900	48,3 x 2,0	1	
140090-248-12-12	1200	48,3 x 2,0	1	

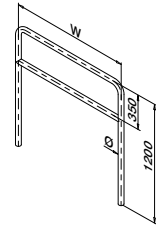

MOD 0091

316		Inox brossé		
OUTDOOR	W	Ø		
140091-248-09-12	900	48,3 x 2,0	1	
140091-248-12-12	1200	48,3 x 2,0	1	

Cache-embases

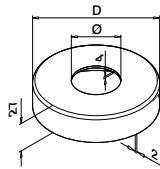

MOD 0511

316		Inox brossé		
OUTDOOR	Ø	D		
140511-048-12	48,3	120	2	

Q-INFO MOD 0090 / 0091

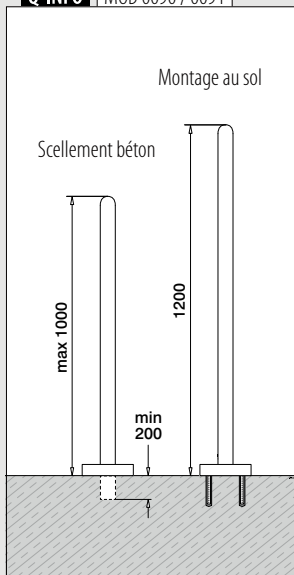

Q-INFO MOD 0090 / 0091



Q-INFO

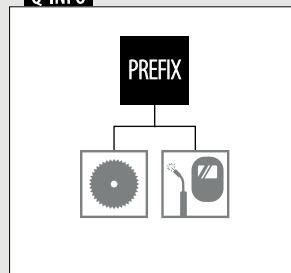

Q-INFO

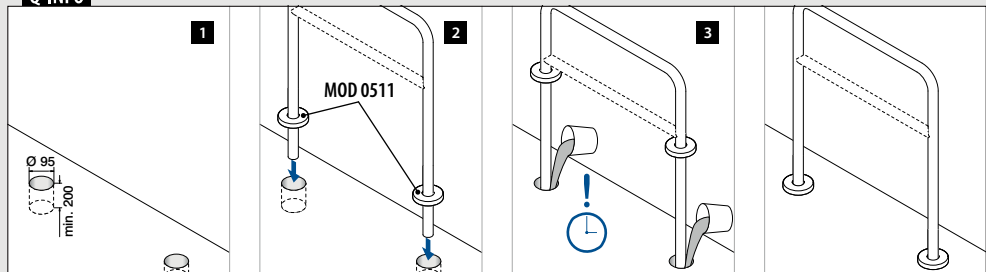



Retrouvez toutes les informations sur les accessoires en finition poli miroir en ligne :



<https://q-ne.ws/Polished23>



POLI MIROIR

Poteaux

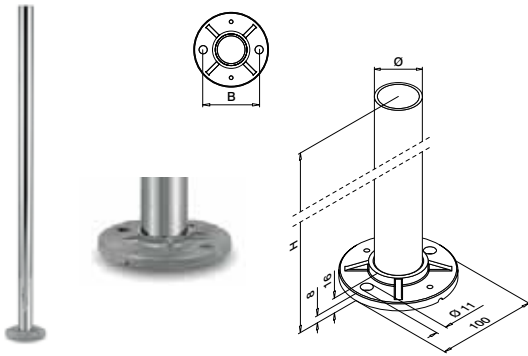

MOD 0921

316	Poli miroir				
OUTDOOR	Ø	H	B	QS-58	467
140921-242-10	42,4 x 2,0	989	75		1



Cache embases



MOD 0512

316	Poli miroir			
OUTDOOR	Ø	D		
140512-042-10	42,4	105		2

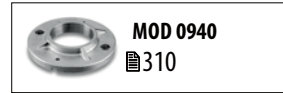

Support mural pour poteau

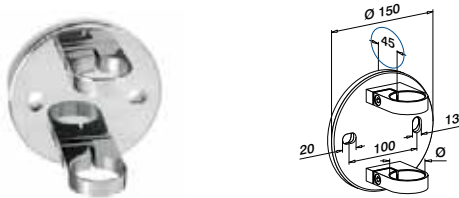

MOD 0551

304	Poli miroir			
INDOOR	Ø			
130551-042-10	42,4	QS-33	464	1

SELL OUT

316	Poli miroir			
OUTDOOR	Ø			
140551-042-10	42,4	QS-32	464	1



Support mural pour poteau

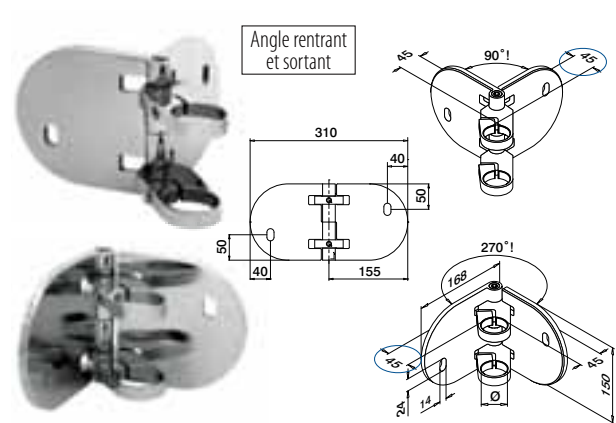

MOD 0555

316	Poli miroir			
OUTDOOR	Ø			
140555-042-10	42,4	QS-32	464	1



SELL OUT Seulement jusqu'à épuisement des stocks.

Q-INFO | MOD 0551 / 0555

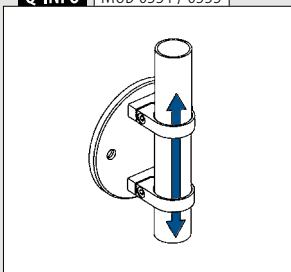

Q-INFO | MOD 0921

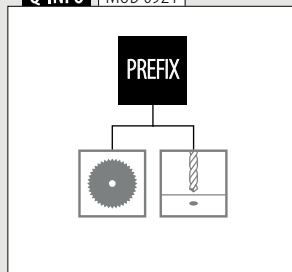

Q-INFO | MOD 0551 / 0552



Pour tube rond

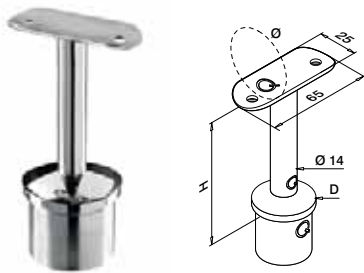

MOD 0710

316	Poli miroir					
OUTDOOR	D	Ø	H			
140710-042-00-10	42,4 x 2,0	42,4	79	QS-11	472	2



Pour tube rond

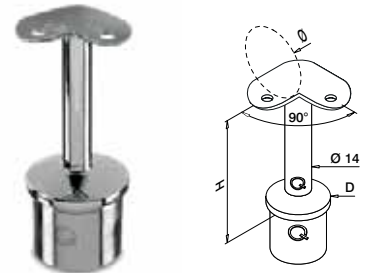

MOD 0710

316	Poli miroir					
OUTDOOR	D	Ø	H			
140710-042-90-10	42,4 x 2,0	42,4	79	QS-11	472	2



Pour tube rond

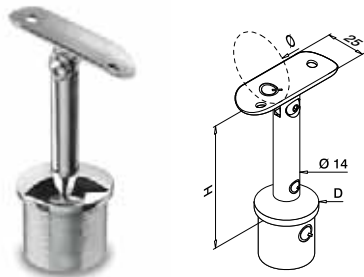

MOD 0718

316	Poli miroir					
OUTDOOR	D	Ø	H			
140718-042-10	42,4 x 2,0	42,4	79	QS-11	472	2



Q-INFO | MOD 071x-042-00

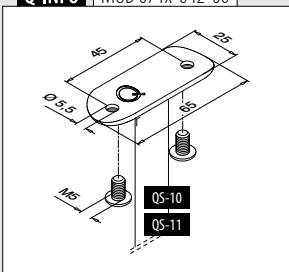

Q-INFO | MOD 0718

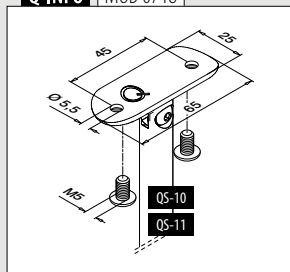

Q-INFO | MOD 071x-04x-90

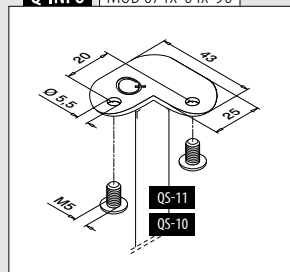

Q-INFO | MOD 071x-04x-90

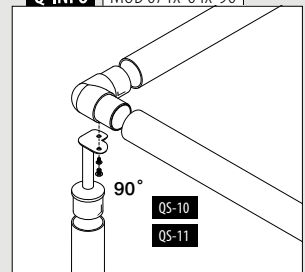

Pour tube rond

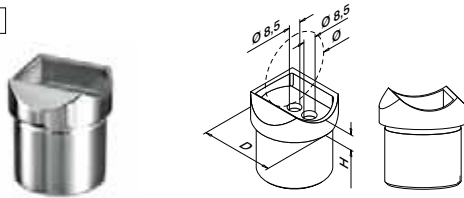

MOD 0770

316	Poli miroir				
OUTDOOR	D	Ø	H		
140770-042-10	42,4 x 2,0	42,4	9	QS-27 472	2



Compatible avec MOD 0303 raccords

Pour tube rond

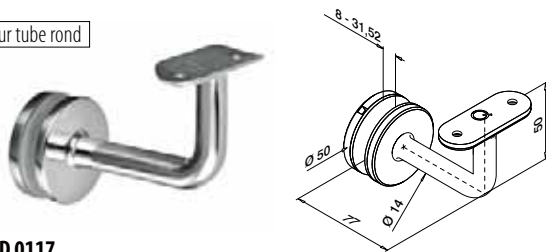

MOD 0117

316	Poli miroir				
OUTDOOR	Ø				
140117-042-10	42,4	QS-11 472		2	
140117-048-10	48,3	QS-11 472		2	



Q-INFO MOD 0770

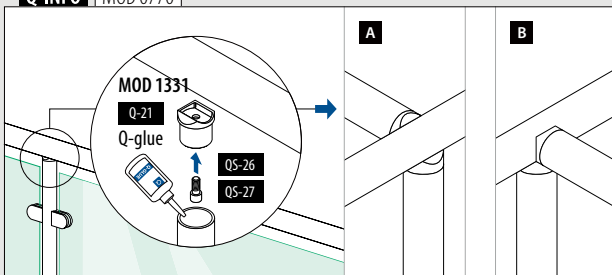

Q-INFO MOD 0117

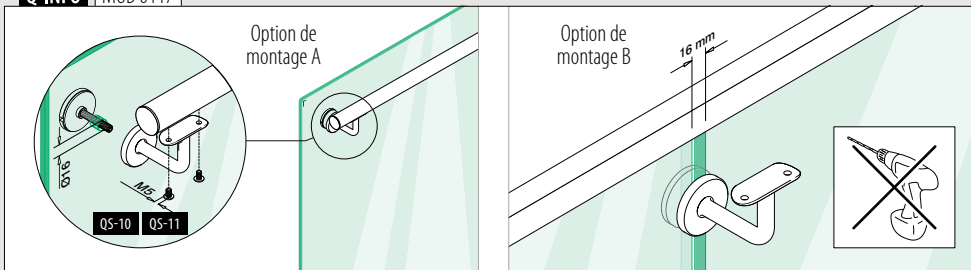

Q-INFO MOD 0117

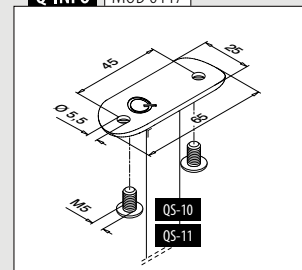

Pour tube rond

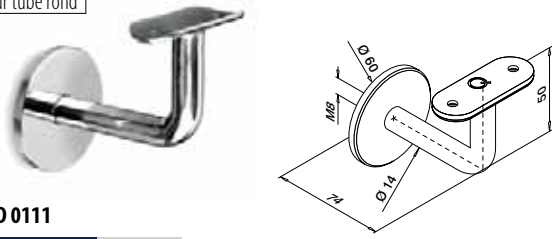

MOD 0111

304 Poli miroir

INDOOR

Ø



SELL
OUT

130111-042-10	42,4	QS-10	472	2
---------------	------	-------	-----	---

316 Poli miroir

OUTDOOR

140111-042-10	42,4	QS-11	472	2
---------------	------	-------	-----	---



Pour tube rond

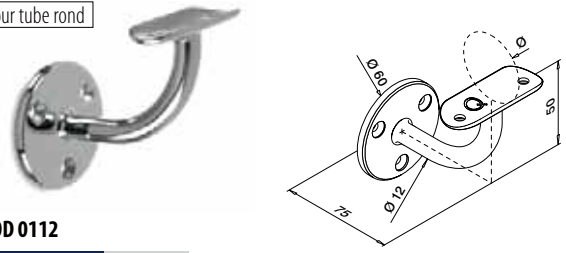

MOD 0112

304 Poli miroir

INDOOR

Ø



SELL
OUT

130112-042-10	42,4	QS-7	471 / QS-10	472 / QS-87	470	2
---------------	------	------	-------------	-------------	-----	---

316 Poli miroir

OUTDOOR

140112-042-10	42,4	QS-50	471 / QS-11	472 / QS-87	470	2
---------------	------	-------	-------------	-------------	-----	---



SELL
OUT

Seulement jusqu'à épuisement des stocks.

Q-INFO | MOD 0111

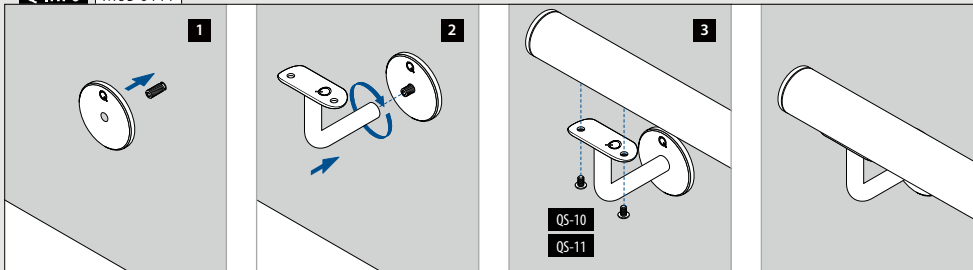

Q-INFO

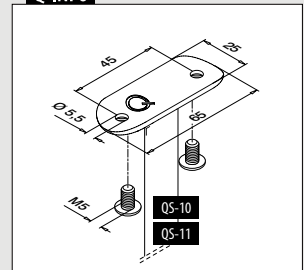

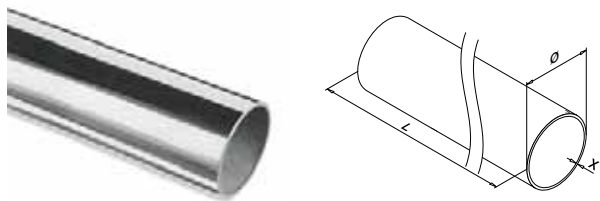

MOD 0900

304 Poli miroir

INDOOR

SELL OUT		Ø	X	
	130900-242-50-10	42,4	2,0	L = 5 m

316 Poli miroir

OUTDOOR

	140900-242-50-10	42,4	2,0	L = 5 m
--	------------------	------	-----	---------



Raccords

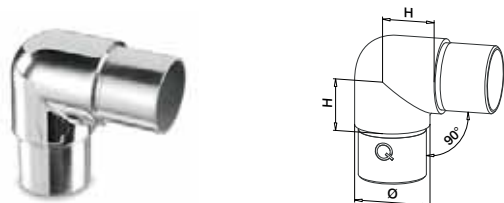

MOD 0303

316 Poli miroir

OUTDOOR

	Pour tube Ø	H	
140303-242-10	42,4 x 2,0	30	2



Compatible avec MOD 0710, 0810 et 4710 supports de main-courante



MOD 5792 - EASY HIT®

304 Brut

INDOOR

SELL OUT		Pour tube Ø	
	135792-242	42,4 x 2,0	2

316 Brut

OUTDOOR

	145792-242	42,4 x 2,0	2
--	------------	------------	---



International Design Modèle Protection

Q-INFO MOD 5792

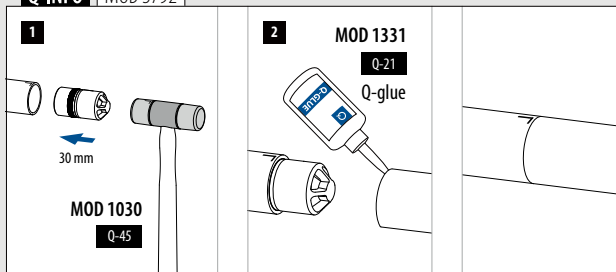

Q-INFO MOD 0900

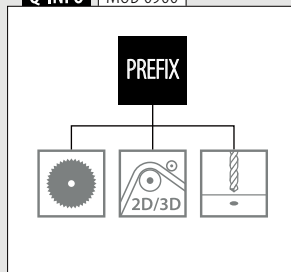



0-70°

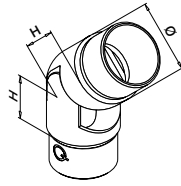

MOD 0312

316 Poli miroir

OUTDOOR	Pour tube Ø	H	
140312-242-10	42,4 x 2,0	27	2



International Design Modèle Protection

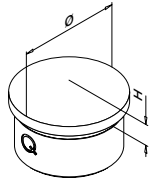

MOD 0729

304 Poli miroir

INDOOR	Pour tube Ø	H	
130729-242-10	42,4 x 2,0	9	2

SELL
OUT

316 Poli miroir

OUTDOOR	Pour tube Ø	H	
140729-242-10	42,4 x 2,0	9	2

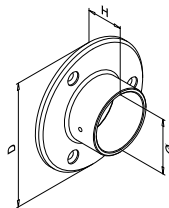

MOD 0505

316 Poli miroir

OUTDOOR	Pour Ø	D	H		
140505-042-10	42,4	95	30	QS-50 ■ 471	2



Supports traversants pour lisse

Pour tube rond

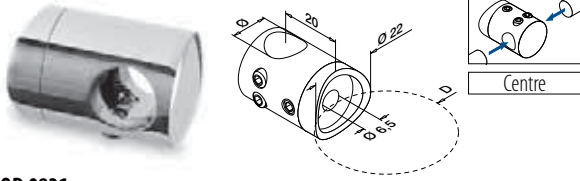

MOD 0831

316	Poli miroir			
OUTDOOR	D	Ø		
140831-042-10	42,4	12	QS-16 ■ 472	4



Barres

Q-TUBE



MOD 1910

316	Poli miroir		
OUTDOOR	Ø		
141910-012-50-10	12	L = 5 m	

PREFIX



Q-INFO MOD 1910

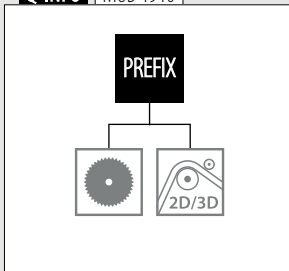

Q-INFO MOD 0831

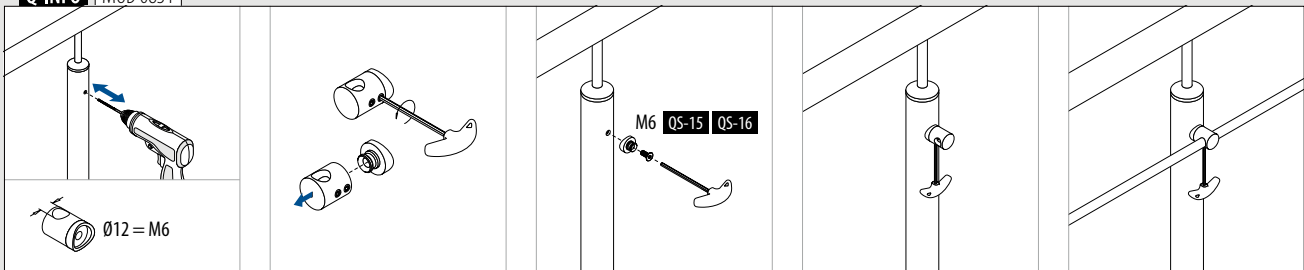

Pincès à tôle - MOD 2800

Pour tube plat

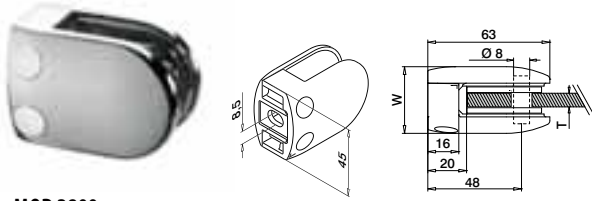

MOD 2800

304 Poli miroir

INDOOR

W

T



SELL OUT	132800-000-10	34	Voir MOD 5028	QS-26	474	4
----------	---------------	----	---------------	-------	-----	---

316 Poli miroir

OUTDOOR

142800-000-10	34	Voir MOD 5028	QS-27	474	4
---------------	----	---------------	-------	-----	---



International Design Modèle Protection

Pour tube rond

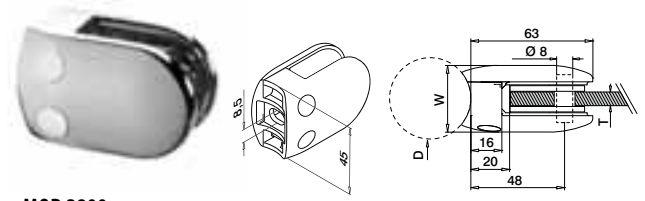

MOD 2800

304 Poli miroir

INDOOR

D

W

T



SELL OUT	132800-042-10	42,4	34	Voir MOD 5028	QS-47	474	4
----------	---------------	------	----	---------------	-------	-----	---

316 Poli miroir

OUTDOOR

142800-042-10	42,4	34	Voir MOD 5028	QS-45	474	4
---------------	------	----	---------------	-------	-----	---



International Design Modèle Protection

Cales caoutchouc pour pincès à tôle MOD 2800



2 pièces par pince à tôle

MOD 5028

Accessoires

	T	Box
205028-02	2	8
205028-03	3	8
205028-04	4	8



MOD 2800 Pincès à verre - poli miroir

433

Goupilles de sécurité

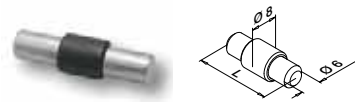

Optionnel pour MOD 2800

MOD 5015

Accessoires

	L	Box
205015-22	22	4

Q-INFO

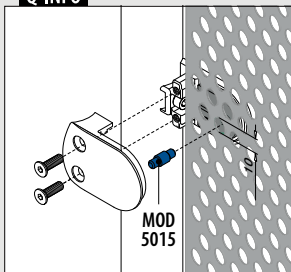

Commander séparément goupilles et matériel de fixation.



Seulement jusqu'à épuisement des stocks.

Pinces à tôle - MOD 4200

Pour tube plat

Entretoise de sécurité comprise

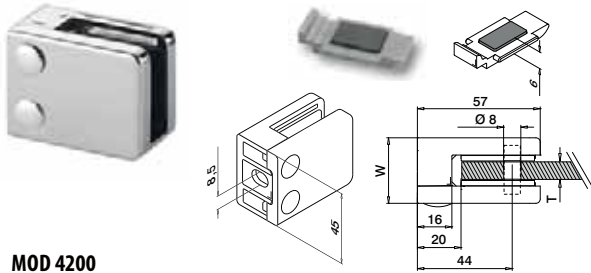

MOD 4200

316		Poli miroir			
OUTDOOR	W	T			
144200-000-10	28	Voir MOD 5042	QS-27	474	4



International Design
Modèle Protection

Pour tube rond

Entretoise de sécurité comprise

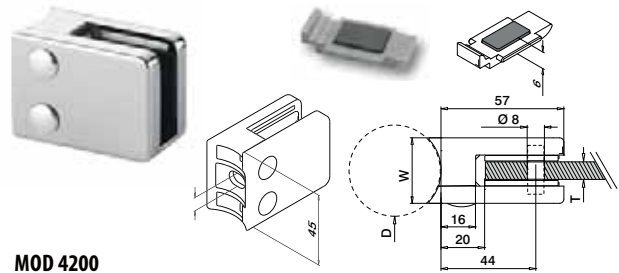

MOD 4200

316		Poli miroir			
OUTDOOR	D	W	T		
144200-042-10	42,4	28	Voir MOD 5042	QS-45	474 4
144200-048-10	48,3	28	Voir MOD 5042	QS-45	474 4



International Design
Modèle Protection

Cales caoutchouc pour pincés à tôle MOD 4200



2 pièces par
pince à tôle

MOD 5042

Accessoires		
	T	
205042-02	2	8
205042-03	3	8
205042-04	4	8

Goupilles de sécurité

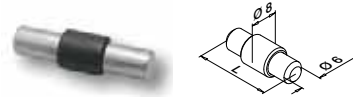

Optionnel pour
MOD 4200

MOD 5015

Accessoires		
	L	
205015-22	22	4



MOD 4200 Pincés à verre - poli miroir
434

Q-INFO

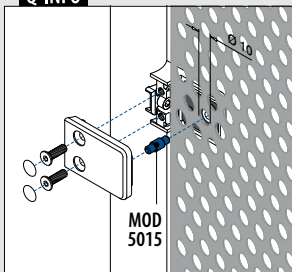



Retrouvez toutes les informations sur pièces à souder en ligne :

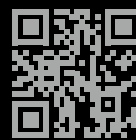

<https://q-ne.ws/Welding23>

PIÈCES À SOUDER

Embases pour poteaux

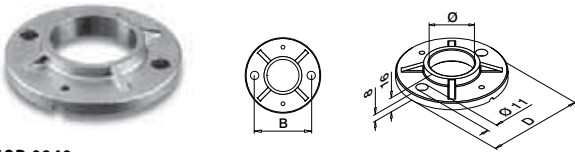

MOD 0940

304		Brut			
INDOOR	Ø	B	D		
130940-042	42,4	75	100	QS-59	467
130940-048	48,3	80	100	QS-59	467
316		Brut			
OUTDOOR	Ø	B	D		
140940-042	42,4	75	100	QS-58	467
140940-048	48,3	80	100	QS-58	467

MOD 0941

316		Brut			
OUTDOOR	Ø	B	D		
140941-048	48,3	90	120	QS-58	467

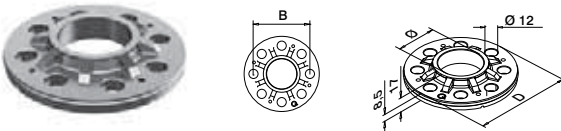

MOD 3504

304		Brut			
INDOOR	Ø	B	D		
133504-042	42,4	80	105	QS-272	464 / QS-59
133504-048	48,3	90	115	QS-272	464 / QS-59
316		Brut			
OUTDOOR	Ø	B	D		
143504-042	42,4	80	105	QS-273	464 / QS-58
143504-048	48,3	90	115	QS-273	464 / QS-58

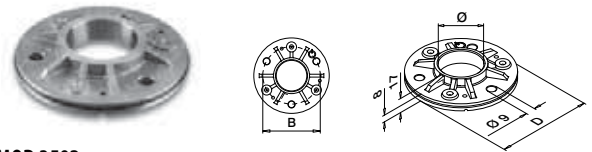

MOD 3502

304		Brut			
INDOOR	Ø	B	D		
133502-042	42,4	80	105	QS-35	467
133502-048	48,3	90	115	QS-35	467
316		Brut			
OUTDOOR	Ø	B	D		
143502-042	42,4	80	105	QS-34	467
143502-048	48,3	90	115	QS-34	467

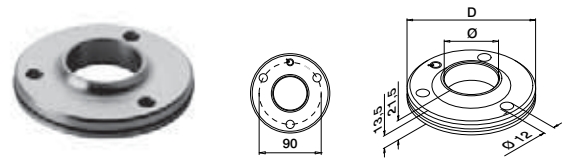

MOD 3505

316		Brut			
OUTDOOR	Ø	B	D		
143505-048	48,3	115	115	QS-273	464



Q-INFO MOD 3504

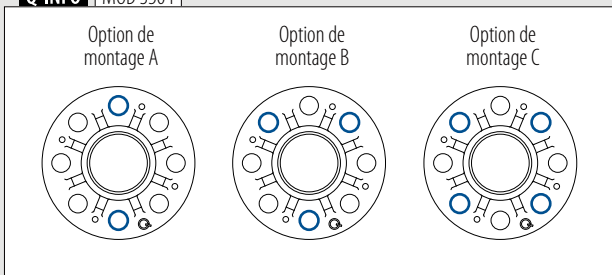

Q-INFO MOD 0940

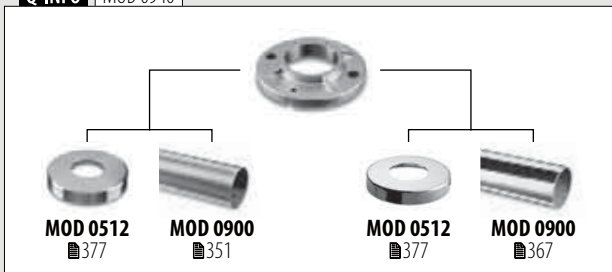

Q-INFO MOD 0941



Q-INFO MOD 3502 / 3505 / 3504

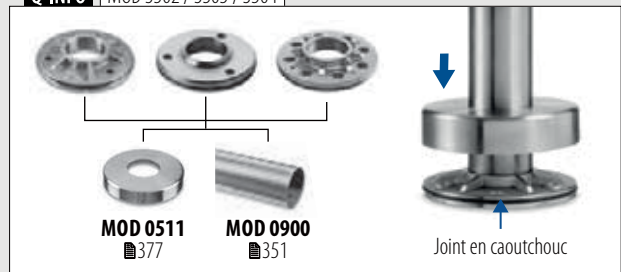

Embases pour poteaux

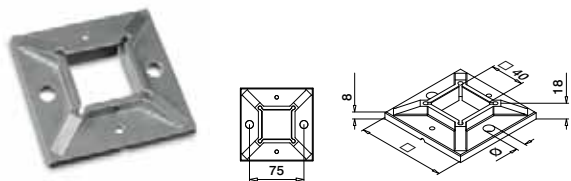

MOD 4940

	304	Brut				
INDOOR	□	Ø	B			
134940-040	100	11	75	QS-59	467	2
	316	Brut				
OUTDOOR						
144940-040	100	11	75	QS-58	467	2

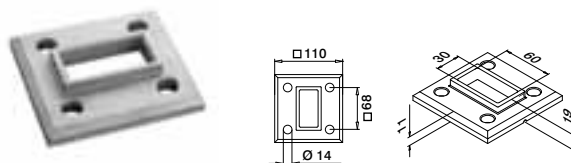

MOD 3503

	316	Brut			
OUTDOOR					
143503-063				QS-559	465

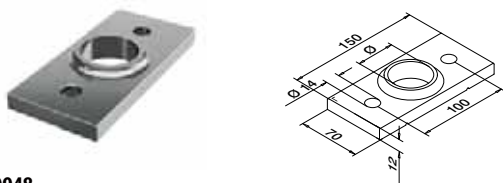

MOD 0948

	316	Brut			
OUTDOOR			Ø		
140948-042-00			42,4	QS-225	473
140948-048-00			48,3	QS-225	473

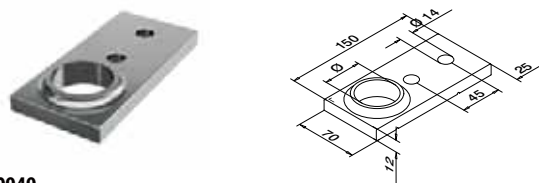

MOD 0949

	316	Brut			
OUTDOOR			Ø		
140949-042-00			42,4	QS-225	473
140949-048-00			48,3	QS-225	473



Cache-embases pour MOD 0948

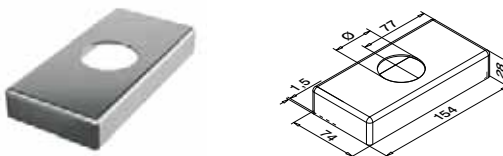

MOD 0514

	316	Inox brossé		
OUTDOOR			Ø	
140514-042-12			42,4	2
140514-048-12			48,3	2



Cache-embases pour MOD 0949

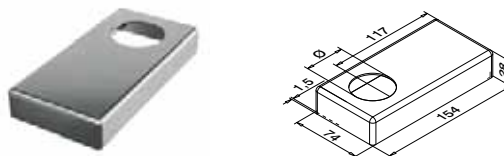

MOD 0515

	316	Inox brossé		
OUTDOOR			Ø	
140515-042-12			42,4	2
140515-048-12			48,3	2



Q-INFO MOD 4940

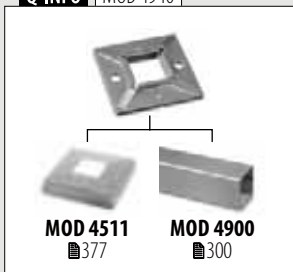

Q-INFO MOD 3503

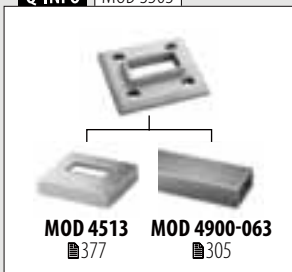

Q-INFO MOD 0948



Q-INFO MOD 0949



Supports de main-courante

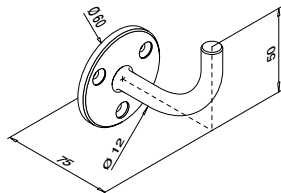

MOD 0113

304	Inox brossé		
INDOOR			
130113	QS-7 471 / QS-87 470	2	
316	Inox brossé		
OUTDOOR			
140113	QS-50 471 / QS-87 470	2	

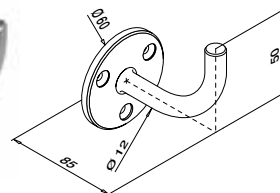

MOD 0109

304	Inox brossé		
INDOOR			
130109	QS-7 471 / QS-87 470	2	

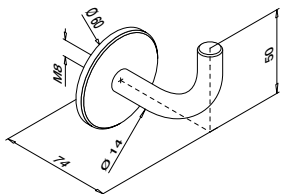

MOD 0114

304	Inox brossé		
INDOOR			
SELL OUT 130114	QS-1 471	2	
316	Inox brossé		
OUTDOOR			
SELL OUT 140114	QS-2 471	2	

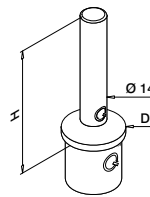

MOD 0695

304	Inox brossé		
INDOOR			
130695	42,4 x 2,0	79	2
316	Inox brossé		
OUTDOOR			
140695	42,4 x 2,0	79	2

MOD 0696

316	Inox brossé		
OUTDOOR			
140696	48,3 x 2,0	80	2



Platines pour supports de main-courante

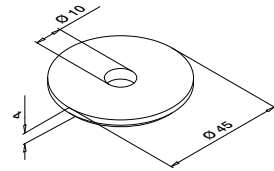

MOD 1937

304	Inox brossé	
INDOOR		
131937		4

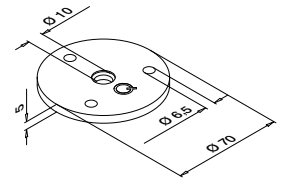

MOD 1936

304	Inox brossé	
INDOOR		
131936	QS-56	4

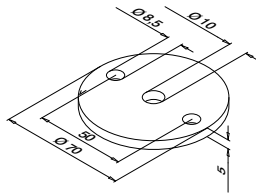

MOD 1939

304	Inox brossé	
INDOOR		
131939	QS-3	8



MOD 1810 379



MOD 1801 379



MOD 1802 379

Pièces à souder pour supports de main-courante

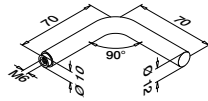

MOD 0813

304	Inox brossé	
INDOOR		
130813	QS-14	2

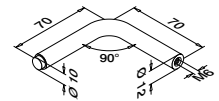

MOD 0814

304	Inox brossé	
INDOOR		
130814-670		2

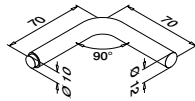

MOD 0815

304	Inox brossé	
INDOOR		
130815		2

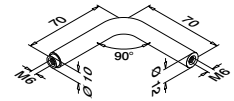

MOD 0816

304	Inox brossé	
INDOOR		
130816	QS-14	2



Q-INFO MOD 0813

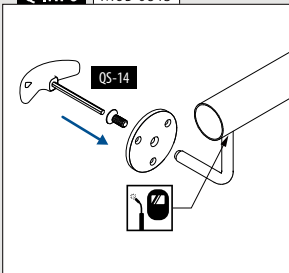

Q-INFO MOD 0814

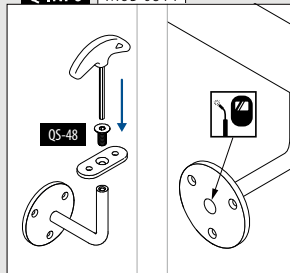

Q-INFO MOD 0815

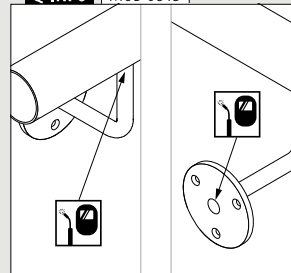

Q-INFO MOD 0816

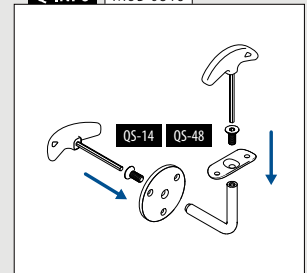

Caches



MOD 4511

304		Inox brossé	
INDOOR	Ø	H	
134511-040-12	108	25	2
316		Inox brossé	
OUTDOOR	Ø	H	
144511-040-12	108	25	2



MOD 4513

316		Inox brossé	
OUTDOOR	Ø	H	
144513-063-12	115	25	2



MOD 0519

316		Inox brossé	
OUTDOOR	Ø	H	
140519	65	1,5	2
Zamak		Aspect inox brossé	
INDOOR	Ø	H	
100519	65	1,5	2



MOD 1514

304		Inox brossé	
INDOOR	Ø	H	
131514-012	12,0	1,5	2
131514-014	14,0	1,5	2



MOD 1515

304		Inox brossé	
INDOOR	Ø	H	
131515-012	12,0	1,5	2

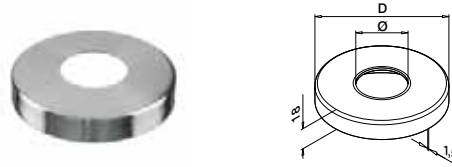

MOD 0512

304		Inox brossé	
INDOOR	Ø	D	
130512-033-12	33,7	105	2
130512-042-12	42,4	105	2
130512-048-12	48,3	105	2
316		Inox brossé	
OUTDOOR	Ø	D	
140512-033-12	33,7	105	2
140512-042-12	42,4	105	2
140512-048-12	48,3	105	2
316		Poli miroir	
OUTDOOR	Ø	D	
140512-042-10	42,4	105	2
140512-048-10	48,3	105	2



MOD 0511

304		Inox brossé	
INDOOR	Ø	D	
130511-042-12	42,4	110	2
130511-048-12	48,3	120	2
316		Inox brossé	
OUTDOOR	Ø	D	
140511-042-12	42,4	110	2
140511-048-12	48,3	120	2

MOD 0513

304		Inox brossé	
INDOOR	Ø	D	
130513-042-12	42,4	125	2
130513-048-12	48,3	125	2
130513-060-12	60,3	125	2
316		Inox brossé	
OUTDOOR	Ø	D	
140513-042-12	42,4	125	2
140513-048-12	48,3	125	2

Q-INFO MOD 0519

Pour MOD 0109,
0113 et 0114

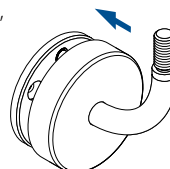

MOD 0519

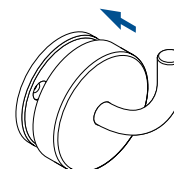

MOD 0519



Berceaux pour tube

Pour tube plat



MOD 1810

304		Inox brossé	
INDOOR			
131810-000-12	QS-48	472 / QS-10	472
			8
316		Inox brossé	
OUTDOOR			
141810-000-12	QS-89	472 / QS-11	472
			8



Pour tube rond

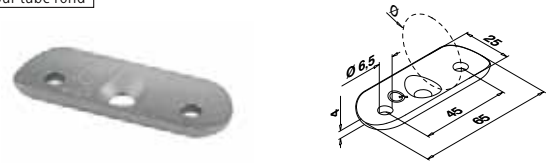

MOD 1810

304		Inox brossé	
INDOOR			
131810-033-12	33,7	QS-48	472 / QS-10
			472
			8
131810-042-12	42,4	QS-48	472 / QS-10
			472
			8
131810-048-12	48,3	QS-48	472 / QS-10
			472
			8
316		Inox brossé	
OUTDOOR			
141810-042-12	42,4	QS-89	472 / QS-11
			472
			8
141810-048-12	48,3	QS-89	472 / QS-11
			472
			8



Pour tube plat

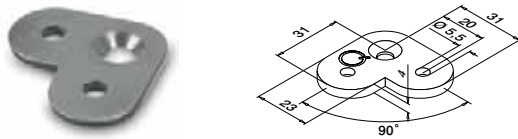

MOD 1802

304		Inox brossé	
INDOOR			
131802-000	QS-48	472 / QS-10	472
			8



Pour tube rond

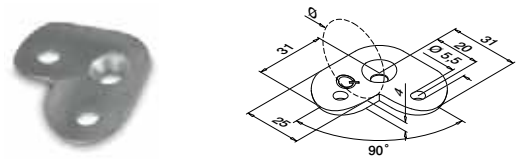

MOD 1802

304		Inox brossé	
INDOOR			
131802-042	42,4	QS-48	472 / QS-10
			472
			8
131802-048	48,3	QS-48	472 / QS-10
			472
			8



Pour tube plat

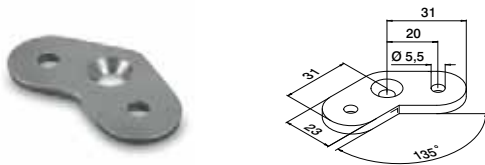

MOD 1801

304		Inox brossé	
INDOOR			
131801-000	QS-48	472 / QS-10	472
			8



Pour tube rond

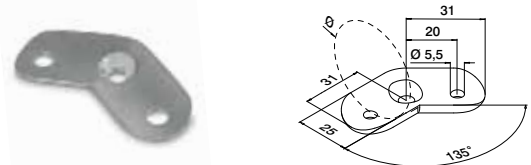

MOD 1801

304		Inox brossé	
INDOOR			
131801-042	42,4	QS-48	472 / QS-10
			472
			8
131801-048	48,3	QS-48	472 / QS-10
			472
			8



MOD 0811 335	MOD 0812 335	MOD 5735, 5736 336
------------------------	------------------------	------------------------------

MOD 1936 376	MOD 1937 376	MOD 1939 376
------------------------	------------------------	------------------------

MOD 4811 296	MOD 4733 296
------------------------	------------------------

Pour tube rond

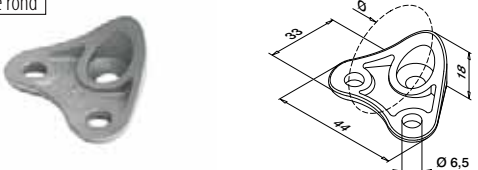

MOD 1820

316		Inox brossé	
OUTDOOR			
141820-042-12	42,4	QS-89	472 / QS-11
			472
			8

Compatible avec MOD 0305 raccords
International Design Modèle Protection



d line
HANDRAIL SYSTEM

Design danois signé *Knud Holscher.*

“Le système d line de mains courantes en inox se caractérise par un design minimaliste et caractéristique particulièrement réussi. Il s’agit d’une gamme fonctionnelle de produits aux lignes élégantes facile à installer, à modifier ou à réparer. Le système de mains courantes d line s’adapte en outre aux architectures les plus complexes sans en compromettre l’esthétique.”

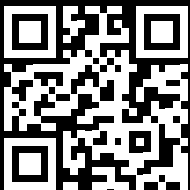

Consultez le catalogue d line sur
<https://q-ne.ws/DLine23>



reddot



Q-railing



BENDYWOOD

NATURAIL

Retrouvez toutes les informations sur le bois en ligne :

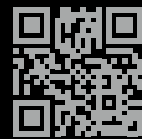

<https://q-ne.ws/Wood23>

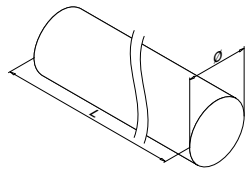
**MOD 0990**

	Hêtre	Brut	
	INDOOR	Ø	
170990-042-36-39	42,0		L = 3,6 m
170990-042-66-39	42,0		L = 6,6 m

PREFIX



Veillez vous référer aux instructions de pose fournies avec le produit. Le bois est un produit naturel, des variations de couleur sont possibles.

Q-INFO**Q-INFO**

Ø 42 R_{min} : 840 mm

Si elles sont conservées dans leur emballage, il est possible de les cintrer jusqu'à quatre mois après leur livraison.

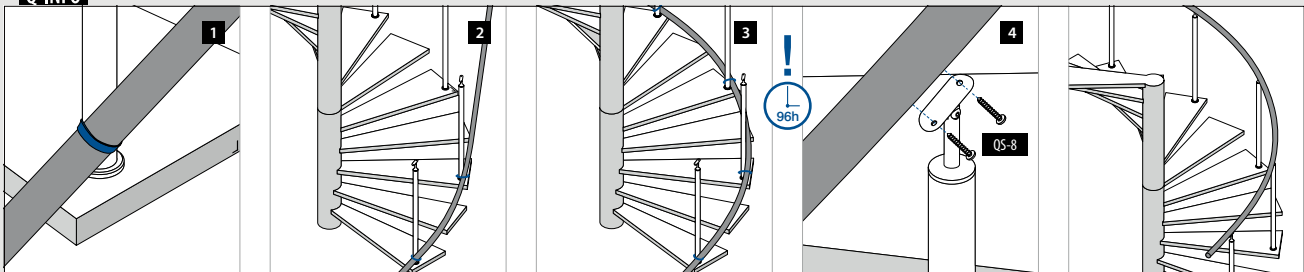
Q-INFO

Mains-courantes

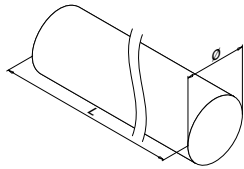

MOD 0950

Hêtre	Brut		
INDOOR	Ø		
170950-042-25-39	42,0		L = 2,5 m

PREFIX

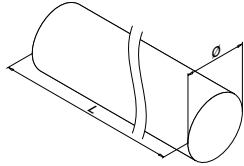

MOD 0950

Hêtre	Naturel verni		
INDOOR	Ø		
170950-042-25-40	42,0		L = 2,5 m

PREFIX

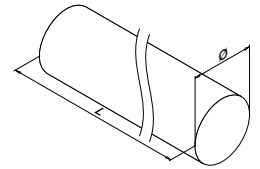

MOD 0950

Chêne	Naturel verni		
INDOOR	Ø		
170950-042-25-43	42,0		L = 2,5 m

PREFIX

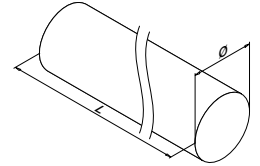

MOD 0950

Kambala	Brut		
OUTDOOR	Ø		
170950-042-25-47	42,0		L = 2,5 m

PREFIX

Accessoires

Chevilles

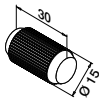

MOD 0203

Bois			
INDOOR	QS		
200203	QS-512		50

Mains-courantes

Raccords

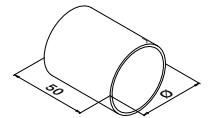

MOD 0793

304	Inox brossé		
INDOOR	Ø		
170793-042	42,0	QS-7	2
316	Inox brossé		
OUTDOOR			
180793-042	42,0	QS-50	2



Q-INFO MOD 0950



Q-INFO

Le bois est un produit naturel; des variations de couleur sont possibles.

Q-INFO MOD 0950

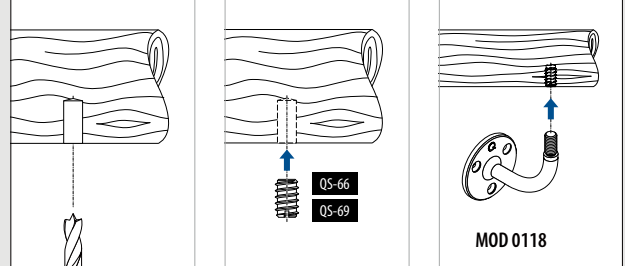

Q-INFO MOD 0950 / 0203

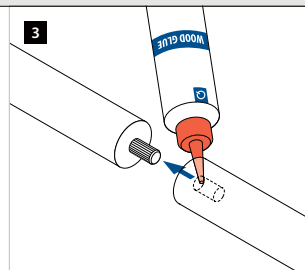
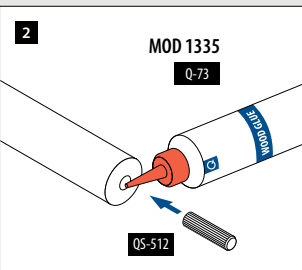
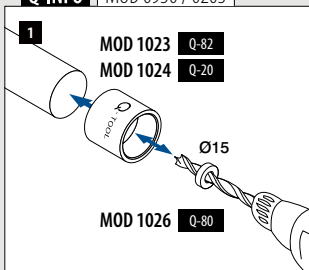

Q-INFO MOD 0950

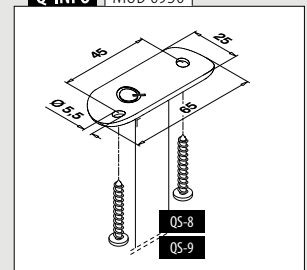



MOD 0313

316	Inox brossé			
OUTDOOR	Ø			
180313-042	42,0	QS-50	471	2

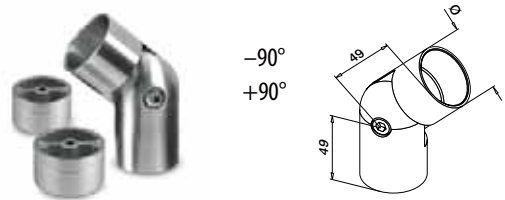

MOD 0308

304	Inox brossé			
INDOOR	Ø			
170308-042	42,0	QS-7	471	2



Mains-courantes

Adaptateur



MOD 0301

304	Inox brossé			
INDOOR	Ø			
170301-042	42,0	QS-7	471	2

316	Inox brossé			
OUTDOOR	Ø			
180301-042	42,0	QS-50	471	2



Incompatible avec MOD 0710, 0810 et 4710 supports de main-courante.

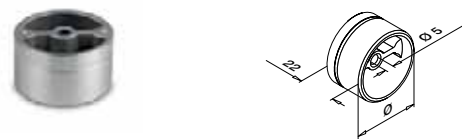

MOD 0792

304	Brut			
INDOOR	Ø			
170792-042	42,0	QS-7	471	2

316	Brut			
OUTDOOR	Ø			
180792-042	42,0	QS-50	471	2



Mains-courantes

Embouts



MOD 0732

304	Inox brossé			
INDOOR	Ø			
170732-042	42,0	QS-7	471	2

316	Inox brossé			
OUTDOOR	Ø			
180732-042	42,0	QS-50	471	2



MOD 0739

304	Inox brossé			
INDOOR	Ø			
170739-042	42,0	QS-7	471	2

316	Inox brossé			
OUTDOOR	Ø			
180739-042	42,0	QS-50	471	2



Q-INFO

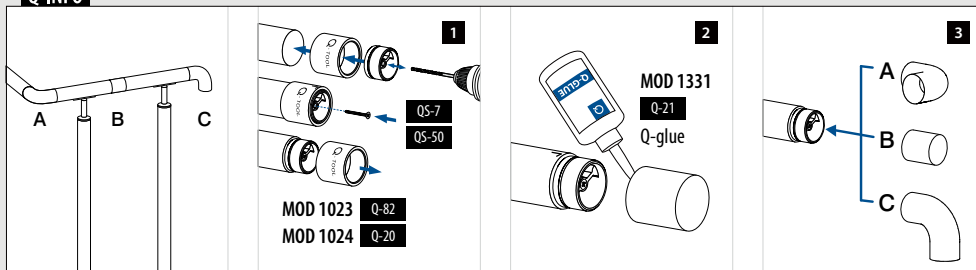



Retrouvez toutes les informations sur le remplissage en verre en ligne :

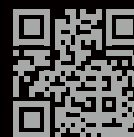

g-ne.ws/Infills23

Q-GLASS

REMPLISSAGE - VERRE

Profitez de la commande de votre garde-corps pour acheter vos remplissages en verre

Verre sur-mesure

- Du verre monolithique de 6 mm d'épaisseur au verre feuilleté trempé de 21,52 mm d'épaisseur
- Verre de couleur ou verre laminé Sentryglas® en option
- Coins arrondis et rebords polis sur demande
- Pré-percé en option

Panneau de verre standard

- Disponible rapidement
- Verre feuilleté trempé
- 8,76 mm, 6 largeurs
- Bords lisses, arrondis et polis
- Coins arrondis

■ Marqués CE ■ Grande qualité ■ Livraison rapide ■ Prix compétitifs clairement indiqués ■ Facile à commander

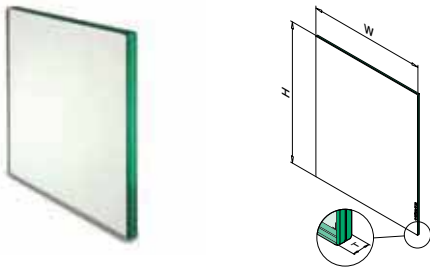
**MOD 5009****Verre de sécurité** Feuilleté

OUTDOOR	H	W	T
195009-070-08	800	700	8,76
195009-080-08	800	800	8,76
195009-090-08	800	900	8,76
195009-095-08	800	950	8,76
195009-100-08	800	1000	8,76
195009-150-08	800	1500	8,76

**Q-INFO****Calcul**

$$H \text{ (m)} \times W \text{ (m)} \times 2,5 \times 8 = \text{kg}$$

Exemple

H	W	Tg
0,8 m	1,0 m	8 mm
$0,8 \times 1,0 \times 2,5 \times 8 = 16,00 \text{ kg}$		

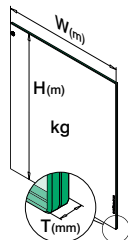
**Q-INFO**

Verre feuilleté de sécurité

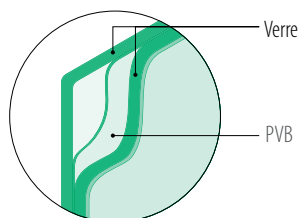
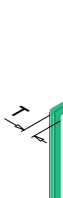

Bord lisse



Coins arrondis



Bord arrondi



Bord poli

Supports

Pour tube plat

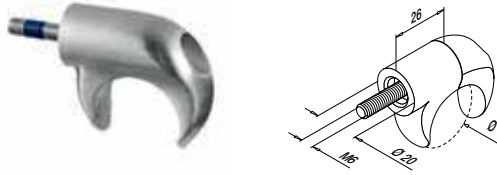

MOD 0860

304 Inox brossé			
INDOOR	Ø		
130860-000	30		2
316 Inox brossé			
OUTDOOR			
140860-000	30		2



International Design
Modèle Protection

Pour tube rond

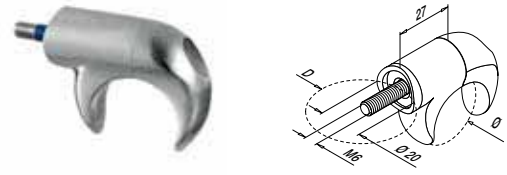

MOD 0860

304 Inox brossé			
INDOOR	D	Ø	
130860-042	42,4	30	2
316 Inox brossé			
OUTDOOR			
140860-042	42,4	30	2
140860-048	48,3	30	2

SELL OUT



International Design
Modèle Protection

Encadrement de vitrage

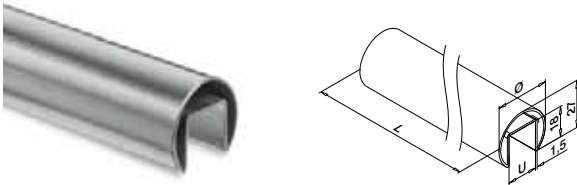

MOD 6930

304 Inox brossé				
INDOOR	Ø	U		
136930-25-12	30	14		L = 2,5 m
136930-50-12	30	14		L = 5 m
316 Inox brossé				
OUTDOOR				
146930-25-12	30	14		L = 2,5 m
146930-50-12	30	14		L = 5 m

SELL OUT

SELL OUT

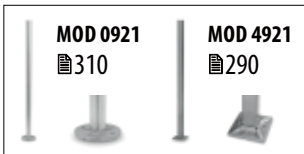

Glass Wing® caoutchoucs pour verre

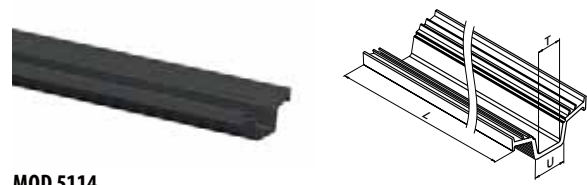

MOD 5114

Accessoires			
Pour verre monolithique	U	T	
205114-050-08	14	8	L = 5 m
205114-050-10	14	10	L = 5 m
Pour verre feuilleté			
205114-050-08	14	8,76 - 9,52	L = 5 m
205114-050-10	14	10,76	L = 5 m

International Design Modèle Protection

SELL OUT Seulement jusqu'à épuisement des stocks.

Q-INFO MOD 6930

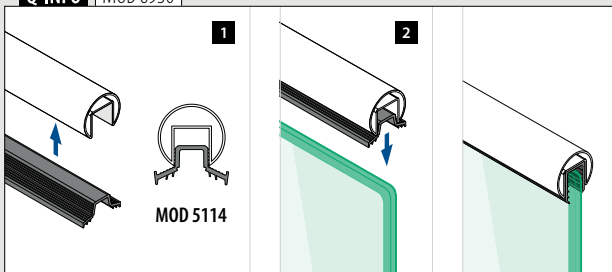

Q-INFO MOD 6930

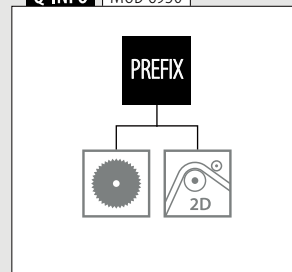

Q-INFO MOD 0860

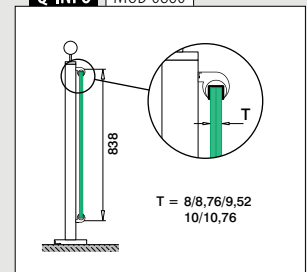



Raccords



MOD 6793

304		Inox brossé	
INDOOR	Pour tube Ø		
136793-030-12	30 x 1,5		2
316		Inox brossé	
OUTDOOR			
146793-030-12	30 x 1,5		2

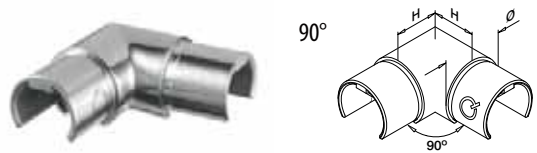

MOD 6333

304		Inox brossé	
INDOOR	Pour tube Ø	H	
136333-12	30 x 1,5	25	2
316		Inox brossé	
OUTDOOR			
146333-12	30 x 1,5	25	2



Raccords

Orientables



MOD 6332

316		Inox brossé	
OUTDOOR	Pour tube Ø	H	
146332-02-12	30 x 1,5	25	2



MOD 6332

316		Inox brossé	
OUTDOOR	Pour tube Ø	H	
146332-01-12	30 x 1,5	25	2



Embouts



MOD 6733

304		Inox brossé	
INDOOR	Pour tube Ø		
136733-030-12	30 x 1,5		2
316		Inox brossé	
OUTDOOR			
146733-030-12	30 x 1,5		2



Retrouvez toutes les
informations sur remplissages
de barres et tubes en ligne :

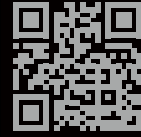

q-ne.ws/Infills23

REMPLISSAGE - BARRE ET TUBE

Remplissage

Barres

Q-TUBE

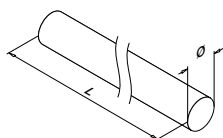

MOD 1910

304 Inox brossé			
INDOOR	Ø		
131910-012-25-12	12	L = 2,5 m	
131910-012-50-12	12	L = 5 m	
316 Inox brossé			
OUTDOOR			
141910-012-25-12	12	L = 2,5 m	
141910-012-50-12	12	L = 5 m	
316 Poli miroir			
OUTDOOR			
141910-012-50-10	12	L = 5 m	



Remplissage

Tubes

Q-TUBE

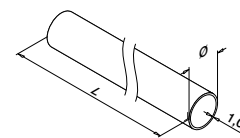

MOD 1900

304 Inox brossé			
INDOOR	Ø		
131900-112-25-12	12	L = 2,5 m	
131900-112-50-12	12	L = 5 m	
304 Inox brossé			
INDOOR			
131900-016-50-12	16	L = 5 m	
316 Inox brossé			
OUTDOOR			
141900-016-50-12	16	L = 5 m	



Remplissage

Raccords

Orientables



Pour barre

-90°
+90°

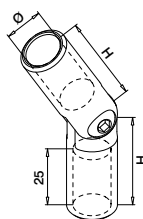

MOD 1312

304 Inox brossé			
INDOOR	Ø	H	
131312-012-12	12	36	6
316 Inox brossé			
OUTDOOR			
141312-012-12	12	36	6



-90°
+90°

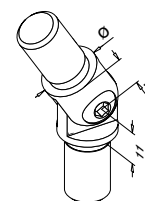

MOD 1302

304 Inox brossé			
INDOOR	Pour tube Ø		
131302-016-12	16 x 1,0		6
316 Inox brossé			
OUTDOOR			
141302-016-12	16 x 1,0		6



Remplissage

Raccords

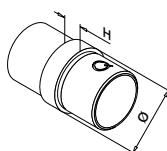

MOD 1790

304 Inox brossé			
INDOOR	Pour tube Ø	H	
131790-112-12	12 x 1,0	5	4
131790-016-12	16 x 1,0	6	4
316 Inox brossé			
OUTDOOR			
141790-016-12	16 x 1,0	6	4



Q-INFO | MOD 1910 / 1900

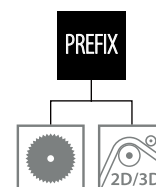

Embouts



MOD 1729

304		Inox brossé		
INDOOR	Pour tube Ø	H		
131729-016-12	16,0 x 1,0	4	2	
316		Inox brossé		
OUTDOOR				
141729-016-12	16,0 x 1,0	4	2	

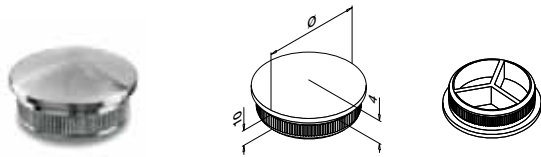

MOD 1759 - EASY HIT®

304		Inox brossé		
INDOOR	Pour tube Ø			
131759-112-12	12 x 1,0	4		
316		Inox brossé		
OUTDOOR				
141759-112-12	12 x 1,0	4		

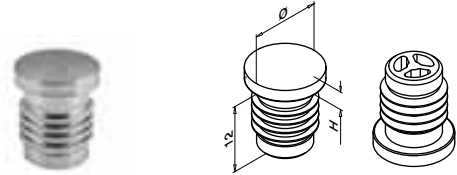

MOD 1759 - EASY HIT®

Plastique		Aspect inox brossé		
INDOOR	Pour tube Ø	H		
151759-112	12 x 1,0	3	4	
151759-016	16 x 1,0	4	4	



MOD 0735

304		Inox brossé		
INDOOR	Ø			
130735-012-12	12	QS-5 471	4	
316		Inox brossé		
OUTDOOR				
140735-012-12	12	QS-6 471	4	



Embouts

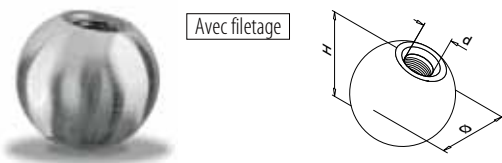

MOD 0220

304		Inox brossé			
INDOOR	Ø	H	d		
130220-020	20	ca. 18,5	M6	6	
130220-025	25	ca. 23,5	M8	6	
130220-030	30	ca. 28,5	M8	6	
130220-050	50	ca. 48,5	M8	2	

SELL OUT

316		Inox brossé			
OUTDOOR					
140220-020	20	ca. 18,5	M6	6	
140220-025	25	ca. 23,5	M8	6	
140220-040	40	ca. 38,5	M8	2	

SELL OUT

SELL OUT

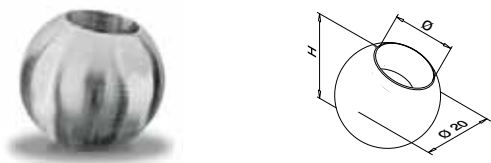

MOD 1221

304		Inox brossé		
INDOOR	Ø	H		
131221-012	12	ca. 17,5	6	
316		Inox brossé		
OUTDOOR				
141221-012	12	ca. 17,5	6	



Q-INFO | MOD 0735

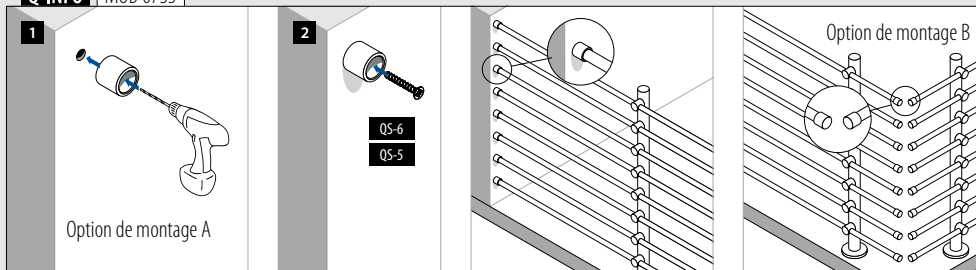

SELL OUT Seulement jusqu'à épaisseur des stocks.

Supports traversants pour lisse

Pour tube plat

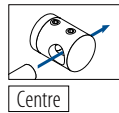
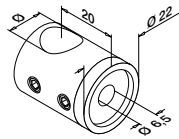

Centre

MOD 0830

304		Inox brossé		
INDOOR	Ø			
130830-000-12	12	QS-15	472	4
316		Inox brossé		
OUTDOOR	Ø			
140830-000-12	12	QS-16	472	4



Pour tube plat

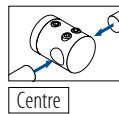
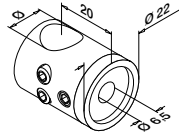

Centre

MOD 0831

304		Inox brossé		
INDOOR	Ø			
130831-000-12	12	QS-15	472	4
316		Inox brossé		
OUTDOOR	Ø			
140831-000-12	12	QS-16	472	4



Pour tube plat

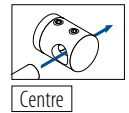
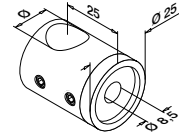

Centre

MOD 0840

304		Inox brossé		
INDOOR	Ø			
130840-000-12	16	QS-19	472	4



Pour tube plat

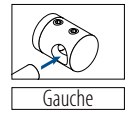
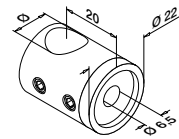

Gauche

MOD 0832

304		Inox brossé		
INDOOR	Ø			
130832-000-12	12	QS-15	472	4
316		Inox brossé		
OUTDOOR	Ø			
140832-000-12	12	QS-16	472	4



Pour tube plat

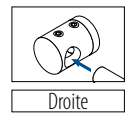
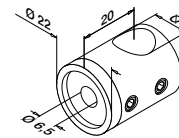

Droite

MOD 0833

304		Inox brossé		
INDOOR	Ø			
130833-000-12	12	QS-15	472	4
316		Inox brossé		
OUTDOOR	Ø			
140833-000-12	12	QS-16	472	4



Q-INFO MOD 0830 / 0831 / 0840

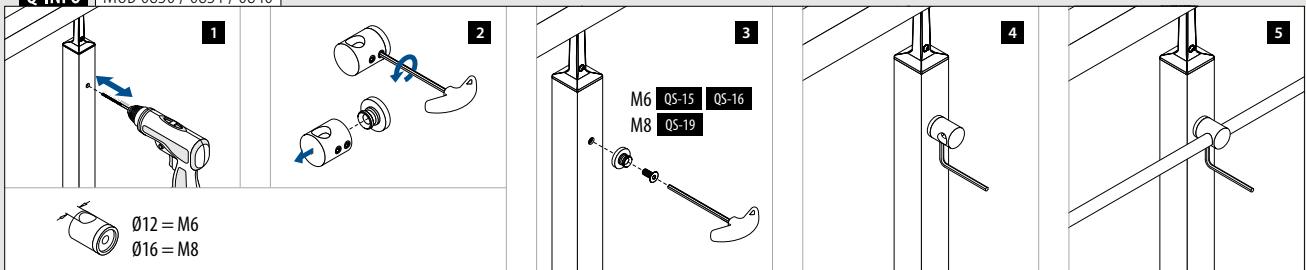

Supports traversants pour lisse

Pour tube rond

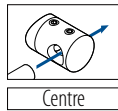
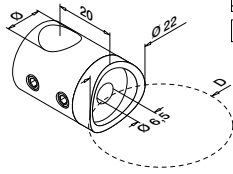

MOD 0830

304 Inox brossé

SELL OUT	INDOOR	D	Ø		
	130830-033-12	33,7	12	QS-15 472	4
	130830-042-12	42,4	12	QS-15 472	4
	130830-048-12	48,3	12	QS-15 472	4

316 Inox brossé

	OUTDOOR	D	Ø		
	140830-042-12	42,4	12	QS-16 472	4
	140830-048-12	48,3	12	QS-16 472	4



Pour tube rond

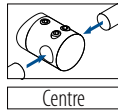
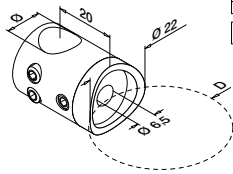

MOD 0831

304 Inox brossé

SELL OUT	INDOOR	D	Ø		
	130831-033-12	33,7	12	QS-15 472	4
	130831-042-12	42,4	12	QS-15 472	4
	130831-048-12	48,3	12	QS-15 472	4

316 Inox brossé

	OUTDOOR	D	Ø		
	140831-042-12	42,4	12	QS-16 472	4
	140831-048-12	48,3	12	QS-16 472	4

316 Poli miroir

	OUTDOOR	D	Ø		
	140831-042-10	42,4	12	QS-16 472	4

MOD 1910
392MOD 1900
392

Pour tube rond

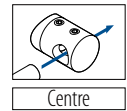
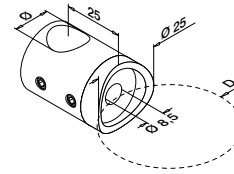

MOD 0840

304 Inox brossé

	INDOOR	D	Ø		
	130840-042-12	42,4	16	QS-19 472	4

316 Inox brossé

	OUTDOOR	D	Ø		
	140840-042-12	42,4	16	QS-20 472	4
	140840-048-12	48,3	16	QS-20 472	4



Pour tube rond

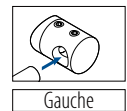
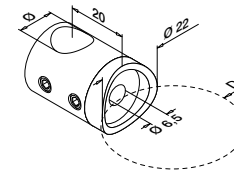

MOD 0832

304 Inox brossé

SELL OUT	INDOOR	D	Ø		
	130832-033-12	33,7	12	QS-15 472	4
	130832-042-12	42,4	12	QS-15 472	4
	130832-048-12	48,3	12	QS-15 472	4

316 Inox brossé

	OUTDOOR	D	Ø		
	140832-042-12	42,4	12	QS-16 472	4



Pour tube rond

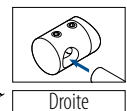
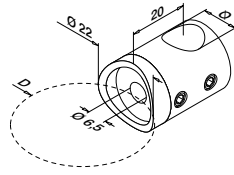

MOD 0833

304 Inox brossé

SELL OUT	INDOOR	D	Ø		
	130833-033-12	33,7	12	QS-15 472	4
	130833-042-12	42,4	12	QS-15 472	4
	130833-048-12	48,3	12	QS-15 472	4

316 Inox brossé

	OUTDOOR	D	Ø		
	140833-042-12	42,4	12	QS-16 472	4



Q-INFO | 304 | 316

10

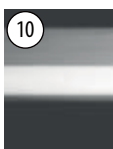

Poli miroir

12

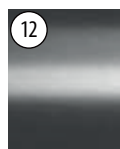

Inox brossé

Seulement jusqu'à épuisement des stocks.

Remplissage

Supports traversants pour lisse

Pour tube rond

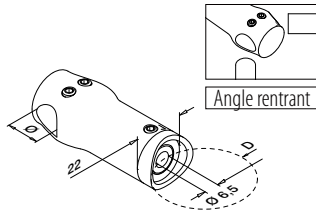

MOD 0834

304 Inox brossé

INDOOR

D	Ø		
42,4	12	QS-15 472	4
48,3	12	QS-15 472	4

316 Inox brossé

OUTDOOR

42,4	12	QS-16 472	4
48,3	12	QS-16 472	4



International Design Modèle Protection

Pour tube rond

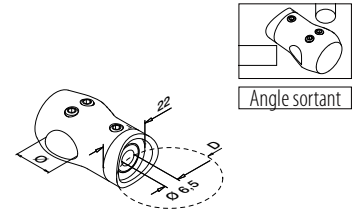

MOD 0839

304 Inox brossé

INDOOR

D	Ø		
42,4	12	QS-15 472	4
48,3	12	QS-15 472	4

316 Inox brossé

OUTDOOR

42,4	12	QS-16 472	4
48,3	12	QS-16 472	4



International Design Modèle Protection

Remplissage

Adaptateurs à verre

Ø 25 mm

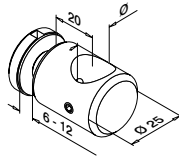

MOD 0755

304 Inox brossé

INDOOR

Ø		
16		4

316 Inox brossé

OUTDOOR

12		4
----	--	---



Remplissage

Supports traversant pour lisse

Fixation sur barre

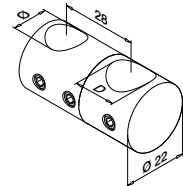

MOD 0827

304 Inox brossé

INDOOR

D	Ø		
12	12		4
16	12		4



SYSTÈMES DE GARDE-CORPS À POTEAUX

REPLISSAGE - BARRE ET TUBE

SEUL SEULEMENT jusqu'à épuisement des stocks.

Q-INFO MOD 0834 / 0839

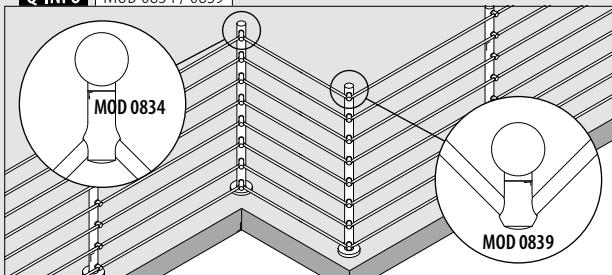

Q-INFO MOD 0755

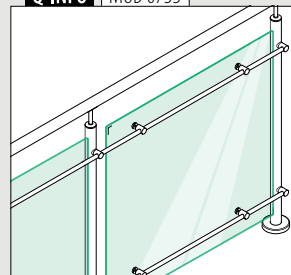

Q-INFO MOD 0827

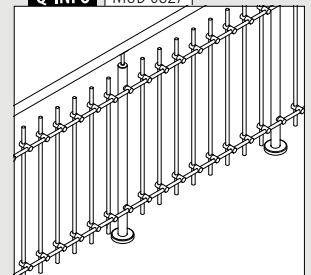

Supports axiaux

Pour tube plat

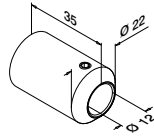

MOD 0850

304 Inox brossé

INDOOR

130850-000	QS-23 472	4
------------	-----------	---

316 Inox brossé

OUTDOOR

140850-000	QS-53 472	4
------------	-----------	---

SELL
OUT

Pour tube rond

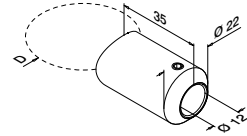

MOD 0850

304 Inox brossé

INDOOR

130850-042	42,4	QS-23 472	4
------------	------	-----------	---

316 Inox brossé

OUTDOOR

140850-042	42,4	QS-53 472	4
------------	------	-----------	---



Supports axiaux

Orientables

Pour tube plat

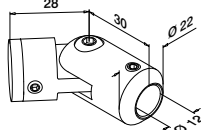
-90°
+90°

MOD 0855

304 Inox brossé

INDOOR

130855-000	QS-15 472	4
------------	-----------	---

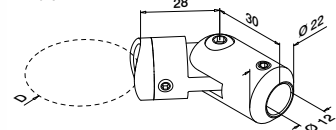

Pour tube rond

-90°
+90°

MOD 0855

304 Inox brossé

INDOOR

130855-042	42,4	QS-15 472	4
------------	------	-----------	---



Q-INFO | MOD 0850-042

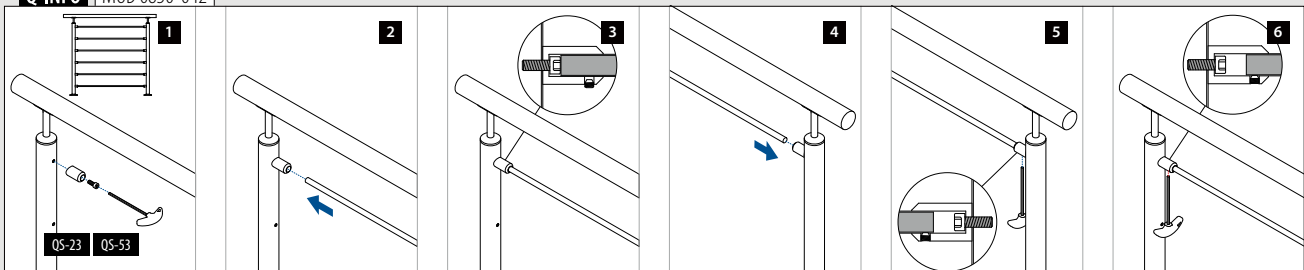



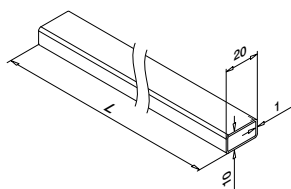

MOD 1940

304 Inox brossé

INDOOR

131940-021-50-12 20 x 10 x 1,0 L = 5 m

316 Inox brossé

OUTDOOR

141940-021-50-12 20 x 10 x 1,0 L = 5 m

PREFIX

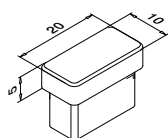

MOD 1712

304 Inox brossé

INDOOR

Pour tube □

131712-021-12 20 x 10 x 1,0 4

316 Inox brossé

OUTDOOR

141712-021-12 20 x 10 x 1,0 4



International Design Modèle Protection

Pour tube plat

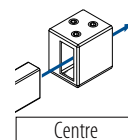
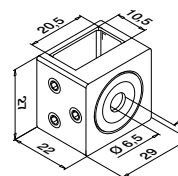

Centre

MOD 4827

304 Inox brossé

INDOOR

Pour tube □

134827-12 20 x 10 x 1,0 QS-15 472 4

316 Inox brossé

OUTDOOR

144827-12 20 x 10 x 1,0 QS-16 472 4



International Design Modèle Protection

Q-INFO

Q-INFO MOD 1940

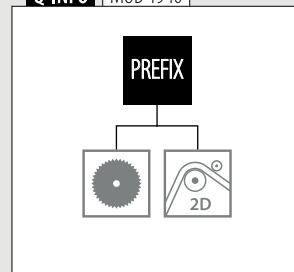
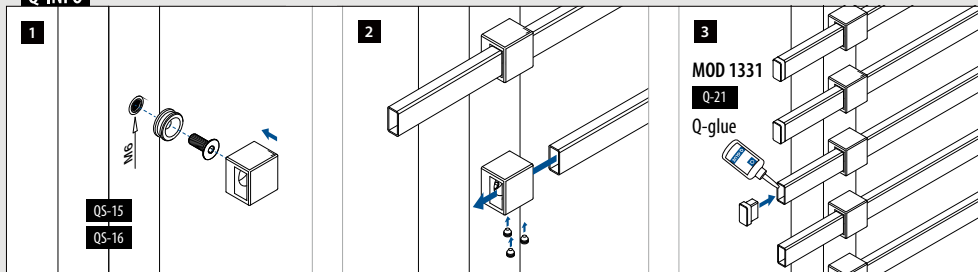



Remplissage

Tubes pour rambarde à barreaux

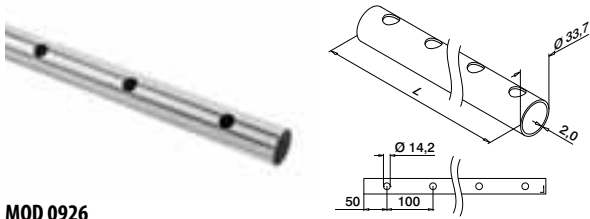

MOD 0926

316 Inox brossé

OUTDOOR

140926-233-25-12

L = 2,5 m



Remplissage

Adaptateurs pour rambarde à barreaux



MOD 0521

Plastique Aspect inox brossé

OUTDOOR

D

SELL OUT 150521

33,7

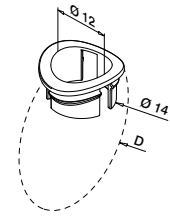

50

Remplissage

Barres pour rambarde à barreaux

Q-TUBE



MOD 1910

316 Inox brossé

OUTDOOR

Ø



141910-012-25-12

12

L = 2,5 m

141910-012-50-12

12

L = 5 m



SYSTEMES DE GARDE-CORPS À POTEAUX

REMPLISSAGE - BARRE ET TUBE

Q-INFO MOD 0926

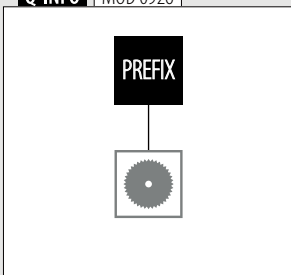

Q-INFO MOD 1910

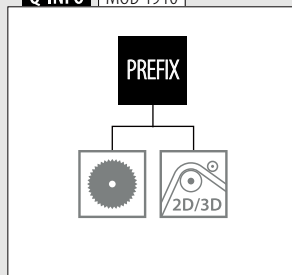

Q-INFO

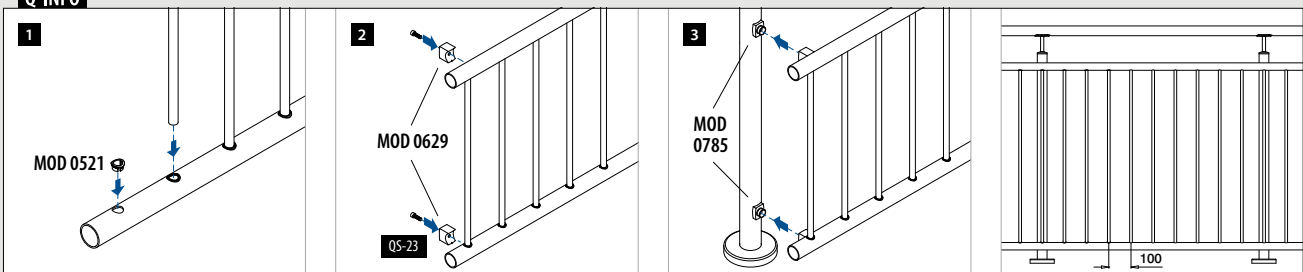

Seulement jusqu'à épuisement des stocks.

Remplissage

Adaptateur pour tube

Pour tube rond

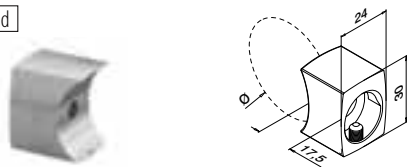

MOD 0629

316 Inox brossé

OUTDOOR

Ø



140629-033	33,7	QS-53 472	4
140629-042	42,4	QS-53 472	4

SELL
OUT

International Design Modèle Protection

Remplissage

Adaptateur pour adaptateur pour tube MOD 0629

Pour tube plat



MOD 0785

316 Inox brossé

OUTDOOR



140785-000-12	QS-16 472	4
---------------	-----------	---



Pour tube rond

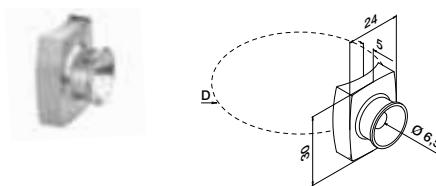

MOD 0785

316 Inox brossé

OUTDOOR

D



140785-042-12	42,4	QS-16 472	4
140785-048-12	48,3	QS-16 472	4



Remplissage

Raccords

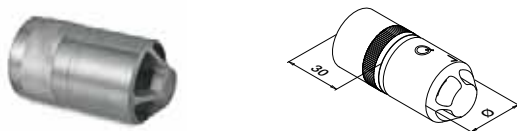

MOD 5792 - EASY HIT®

316 Brut

OUTDOOR

Pour tube Ø



145792-233	33,7 x 2,0	2
------------	------------	---



International Design Modèle Protection

Q-INFO MOD 5792

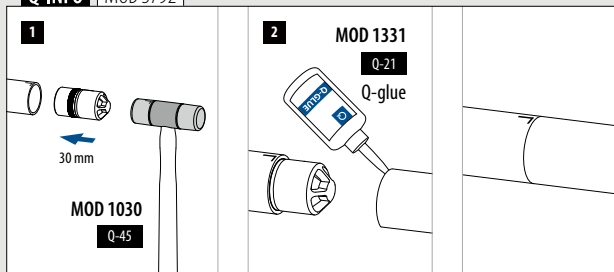
SELL
OUT

Seulement jusqu'à épuisement des stocks.

Embouts

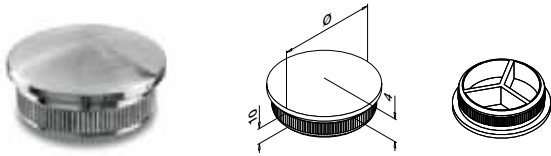

MOD 5729 - EASY HIT®

316	Inox brossé		
OUTDOOR	Pour tube \varnothing		
145729-233-12	33,7 x 2,0	2	

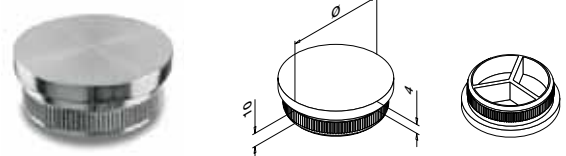

MOD 5732 - EASY HIT®

316	Inox brossé		
OUTDOOR	Pour tube \varnothing		
145732-233-12	33,7 x 2,0	2	



Embases murales pour tube

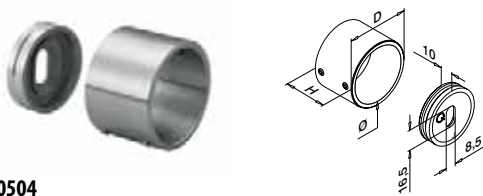

MOD 0504

316	Inox brossé					
OUTDOOR	\varnothing	D	H			
140504-033-12	33,7	41	30	QS-55	470 / QS-22	472 2



Q-INFO MOD 0504

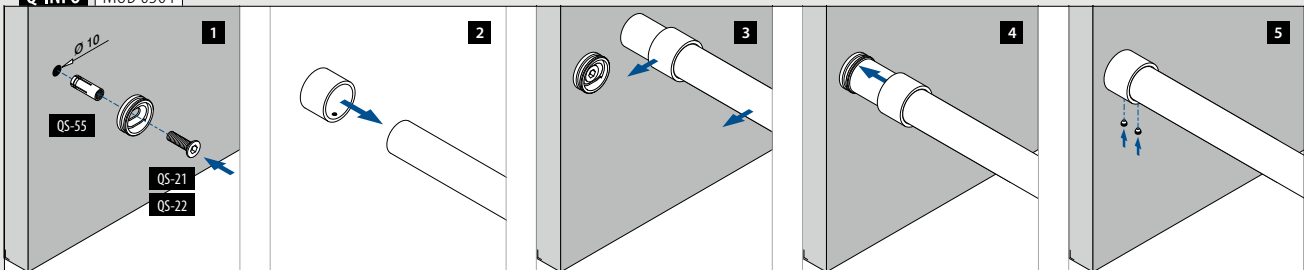



Retrouvez toutes les informations sur le remplissage par câble en ligne :



q-ne.ws/lnfills23

REMPLISSAGE - CÂBLE

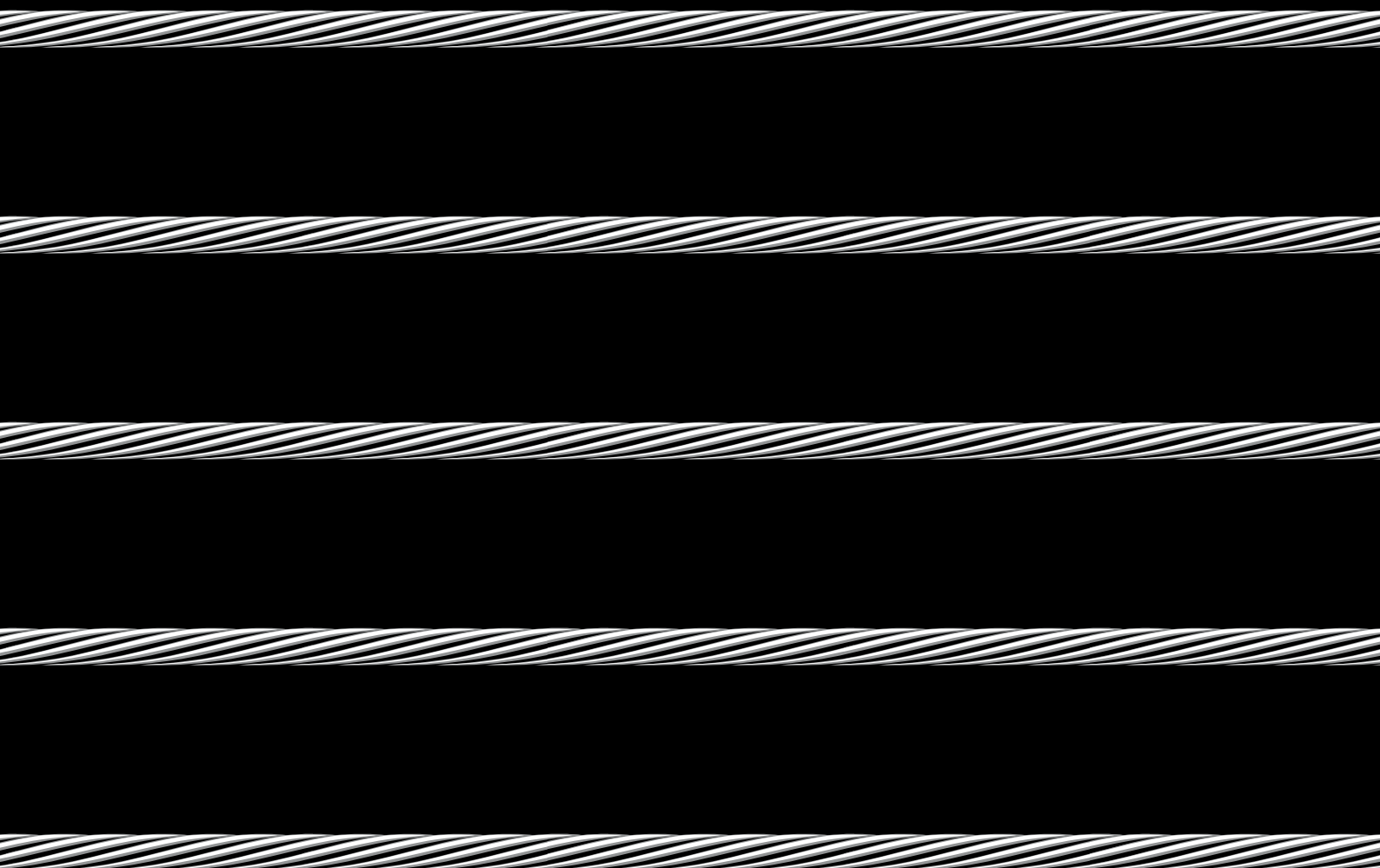

Remplissage

Système de fixation pour câble tendu, 3,2 mm

Ensemble complet

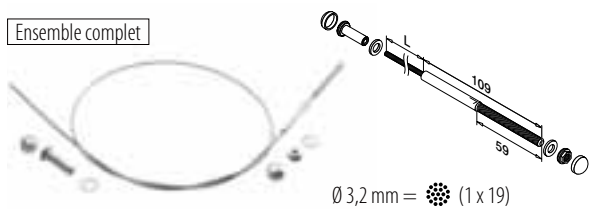

Ø 3,2 mm = (1 x 19)

MOD 7901

316		Inox brossé
OUTDOOR	Câble Ø	
147901-003-01	3,2	L = 1 m
147901-003-02	3,2	L = 2,5 m
147901-003-05	3,2	L = 5 m
147901-003-07	3,2	L = 7,5 m
147901-003-10	3,2	L = 10 m
147901-003-12	3,2	L = 12,5 m
147901-003-20	3,2	L = 20 m

Remplissage

Embouts

Pour MOD 7240

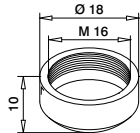

MOD 7245

316		Inox brossé
OUTDOOR		
147245		8

Remplissage

Outil de démontage



MOD 7802

316		Inox brossé
OUTDOOR	Pour câble Ø	
207802-003	3,2	1

Remplissage

Adaptateurs

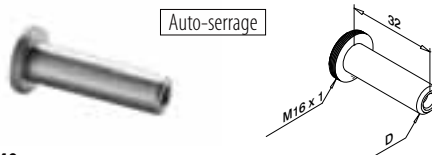

MOD 7240

316		Inox brossé
OUTDOOR	Pour câble Ø	D
147240-003	3,2	9,3

International Design Modèle Protection

Remplissage

Entretoises pour câble

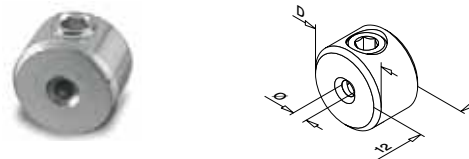

MOD 7400

316		Inox brossé
OUTDOOR	Pour câble Ø	D
147400-003	3,2 - 4,0	18



Q-INFO MOD 7400

Toujours utiliser une entretoise pour câble pour transférer les charges

Q-INFO MOD 7901-003

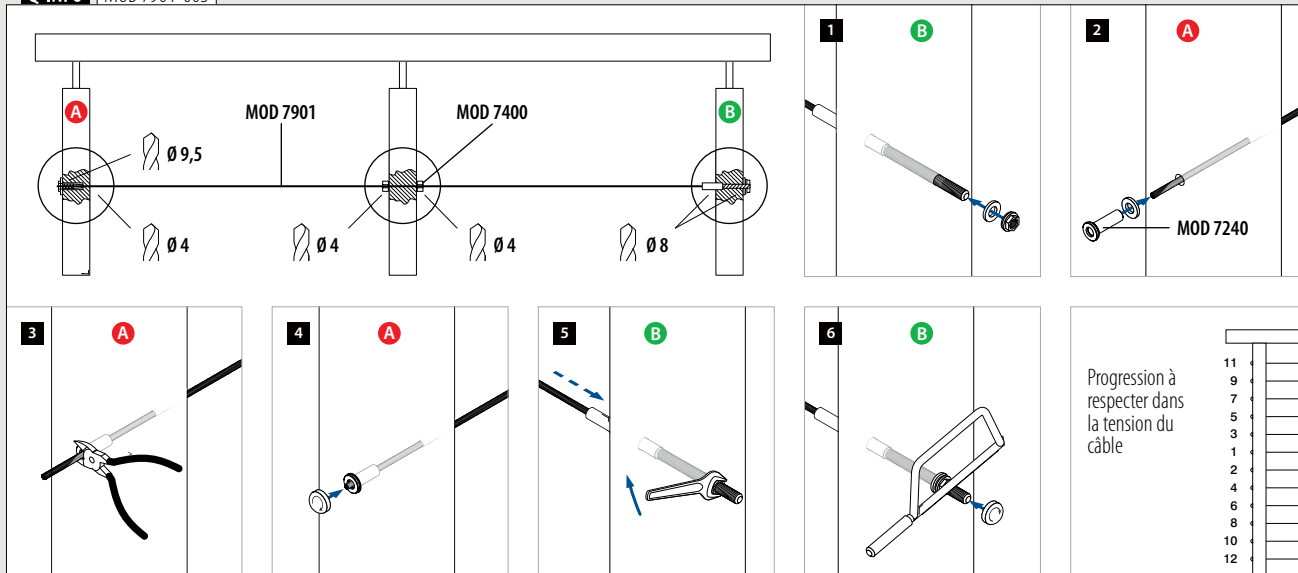

SYSTEMES DE GARDE-CORPS À POTEAUX

REMPLISSAGE - CÂBLE - FAST FIX

Remplissage

Système de fixation pour câble tendu, 4,0 mm

Ensemble complet

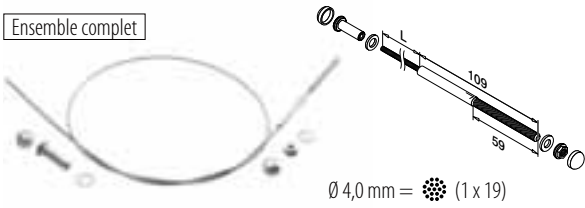

∅ 4,0 mm = (1 x 19)

MOD 7901

316		Inox brossé
OUTDOOR	Câble ∅	
147901-004-01	4,0	L = 1 m
147901-004-02	4,0	L = 2,5 m
147901-004-05	4,0	L = 5 m
147901-004-07	4,0	L = 7,5 m
147901-004-10	4,0	L = 10 m
147901-004-12	4,0	L = 12,5 m
147901-004-20	4,0	L = 20 m

Remplissage

Embouts

Pour MOD 7240

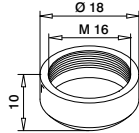

MOD 7245

316		Inox brossé
OUTDOOR		
147245		8

Remplissage

Outil de démontage



MOD 7802

316		Inox brossé
OUTDOOR	Pour câble ∅	
207802-004	4,0	1

Remplissage

Adaptateurs



Auto-serrage

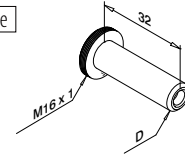

MOD 7240

316		Inox brossé
OUTDOOR	Pour câble ∅	D
147240-004	4,0	11,3

International Design Modèle Protection

Remplissage

Entretoises pour câble

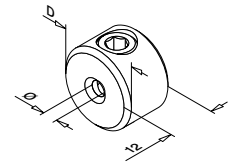

MOD 7400

316		Inox brossé
OUTDOOR	Pour câble ∅	D
147400-003	3,2 - 4,0	18



Q-INFO MOD 7400 / 7401

Toujours utiliser une entretoise pour câble pour transférer les charges

Q-INFO MOD 7901-004

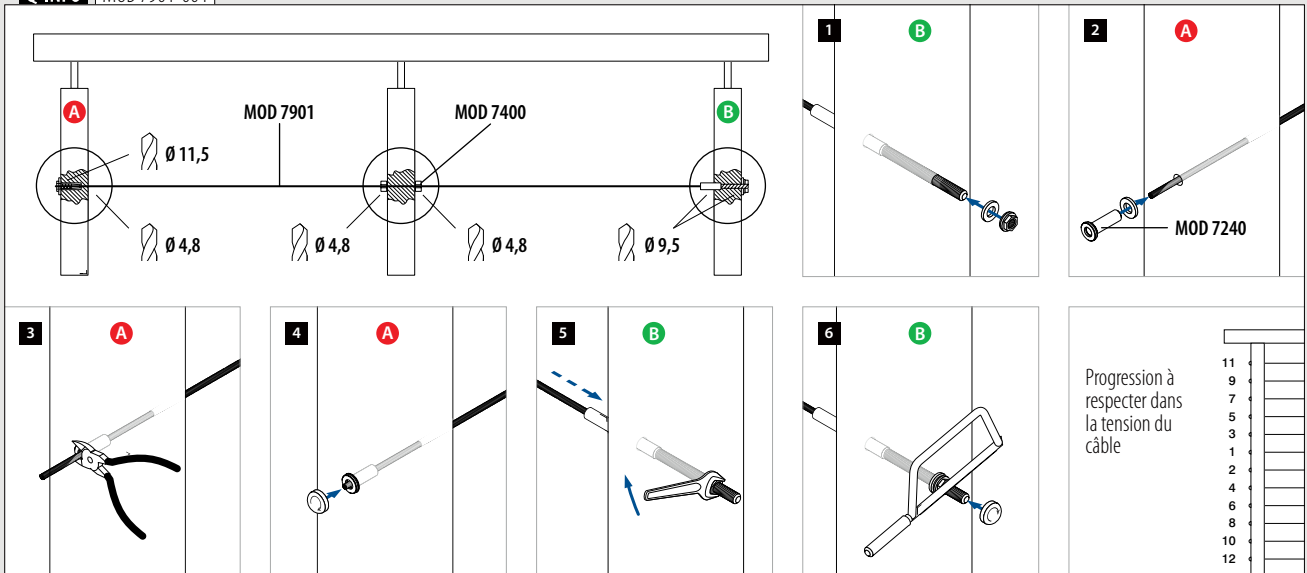

Progression à respecter dans la tension du câble

11
9
7
5
3
1
2
4
6
8
10
12

Entretoises pour câble pour installation en rampant

Pour tube plat

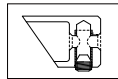
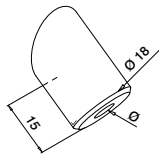

Ouverture basse

+/- 35°

MOD 7401

304 Inox brossé		
INDOOR	Pour câble Ø	
137401-000-02	3,2 - 4,0	6
316 Inox brossé		
OUTDOOR		
147401-000-02	3,2 - 4,0	6



Pour tube rond

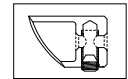
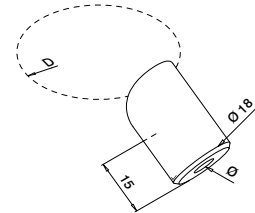

Ouverture basse

+/- 35°

MOD 7401

304 Inox brossé			
INDOOR	D	Pour câble Ø	
137401-042-02	42,4	3,2 - 4,0	6
316 Inox brossé			
OUTDOOR			
147401-042-02	42,4	3,2 - 4,0	6



Pour tube plat

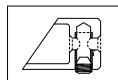
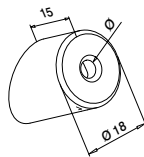

Ouverture haute

+/- 35°

MOD 7401

304 Inox brossé		
INDOOR	Pour câble Ø	
137401-000-01	3,2 - 4,0	6
316 Inox brossé		
OUTDOOR		
147401-000-01	3,2 - 4,0	6



Pour tube rond

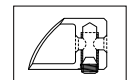
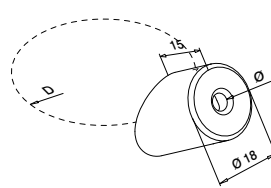

Ouverture haute

+/- 35°

MOD 7401

304 Inox brossé			
INDOOR	D	Pour câble Ø	
137401-042-01	42,4	3,2 - 4,0	6
316 Inox brossé			
OUTDOOR			
147401-042-01	42,4	3,2 - 4,0	6



Adaptateurs pour installation en rampant

Pour tube plat

Haut et bas

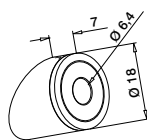

+/- 35°

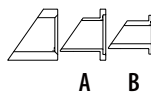

A B

MOD 7403

304 Inox brossé		
INDOOR	Pour câble Ø	
137403-000	3,2 - 4,0	6
316 Inox brossé		
OUTDOOR		
147403-000	3,2 - 4,0	6

Pour tube rond

Haut et bas

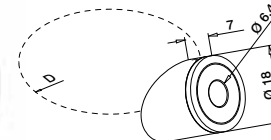

+/- 35°

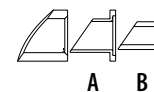

A B

MOD 7403

304 Inox brossé			
INDOOR	D	Pour câble Ø	
137403-042	42,4	3,2 - 4,0	6
316 Inox brossé			
OUTDOOR			
147403-042	42,4	3,2 - 4,0	6

International Design Modèle Protection

International Design Modèle Protection

Q-INFO MOD 7403

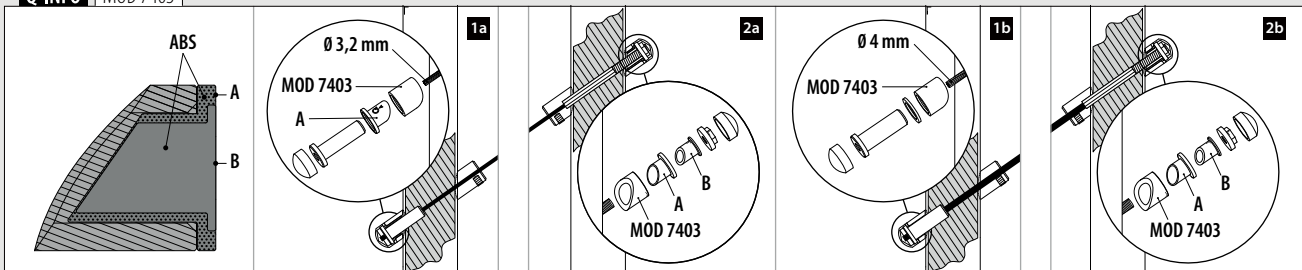

Remplissage

Tendeurs

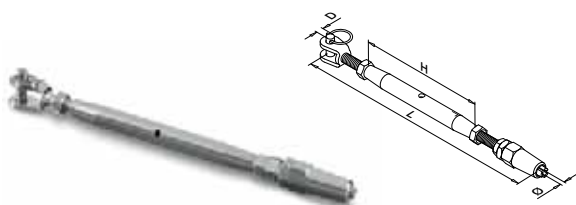

MOD 7250

304		Inox brossé			
INDOOR	Pour câble Ø	D	H	L	
137250-003	3,2	5	90	155 - 230	2
137250-006	6,0	9	125	270 - 325	2
316		Inox brossé			
OUTDOOR					
147250-003	3,2	5	90	155 - 230	2
147250-006	6,0	9	125	270 - 325	2



Remplissage

Câbles

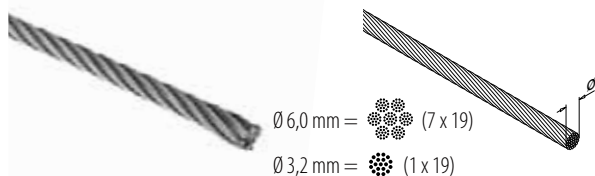

MOD 7900

304		Inox brossé	
INDOOR	Ø		
137900-003-10	3,2	L = 10 m	
137900-003-50	3,2	L = 50 m	
137900-003-01	3,2	L = 100 m	
137900-006-10	6,0	L = 10 m	
137900-006-50	6,0	L = 50 m	
137900-006-01	6,0	L = 100 m	
316		Inox brossé	
OUTDOOR			
147900-003-10	3,2	L = 10 m	
147900-003-50	3,2	L = 50 m	
147900-003-01	3,2	L = 100 m	
147900-006-10	6,0	L = 10 m	
147900-006-50	6,0	L = 50 m	
147900-006-01	6,0	L = 100 m	

Seulement jusqu'à épuisement des stocks.

Q-INFO | MOD 7400

Toujours utiliser une entretoise pour câble pour transférer les charges

Q-INFO | MOD 7900-006

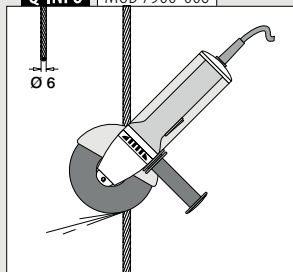

Q-INFO

Pince coupante



MOD 7800
 485

Remplissage

Chapes



MOD 7300

304		Inox brossé			
INDOOR	Pour câble Ø	D	L		
137300-003	3,2	5	50	2	
137300-006	6,0	9	97	2	
316		Inox brossé			
OUTDOOR					
147300-003	3,2	5	50	2	
147300-006	6,0	9	97	2	



Remplissage

Vis à ceillet



MOD 7350

304		Inox brossé			
INDOOR	d	Ø	Pour câble Ø	L	
137350-619	M6	6	3,2	19	10
137350-130	M10	9	6,0	30	10
316		Inox brossé			
OUTDOOR					
147350-619	M6	6	3,2	19	10
147350-130	M10	9	6,0	30	10

Remplissage

Entretoises pour câble

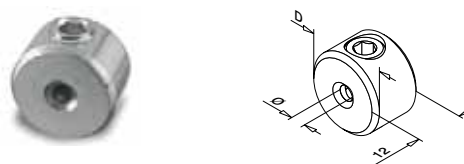

MOD 7400

304		Inox brossé		
INDOOR	Pour câble Ø	D		
137400-003	3,2	18	6	
137400-006	6,0	20	6	
316		Inox brossé		
OUTDOOR				
147400-003	3,2	18	6	
147400-006	6,0	20	6	



Système de fixation pour câble tendu

Q-INFO

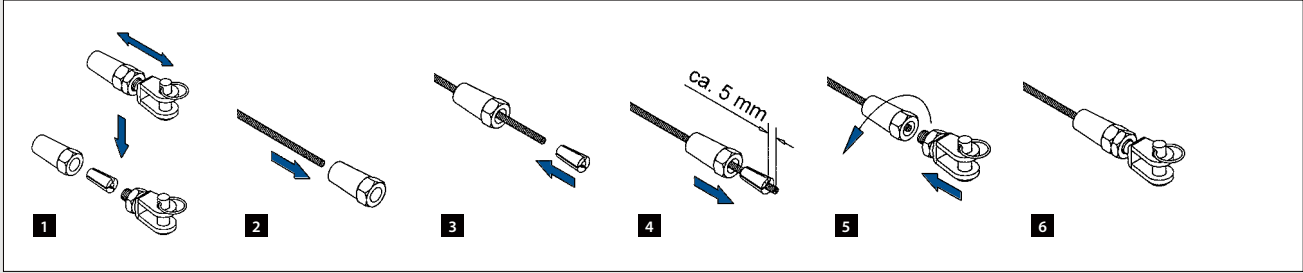

Q-INFO

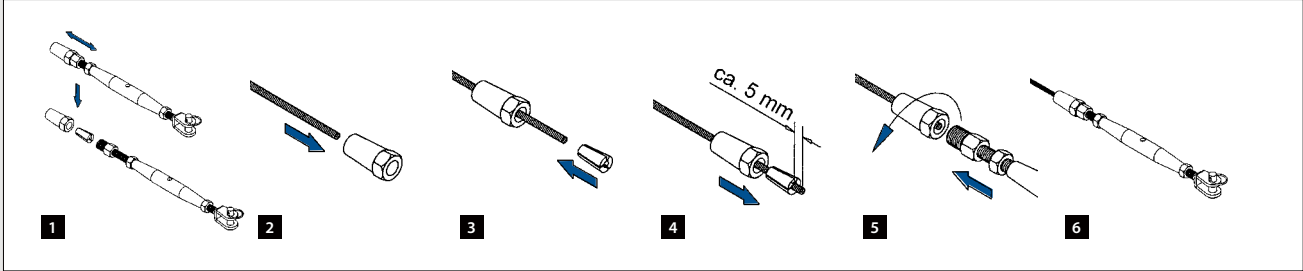

Q-INFO

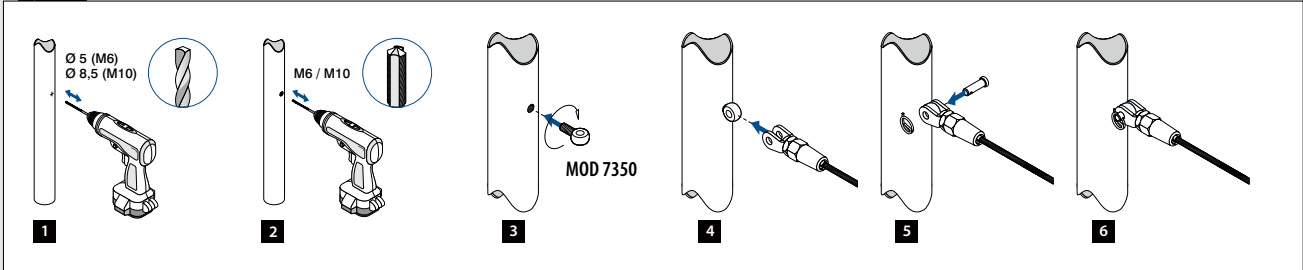

Q-INFO

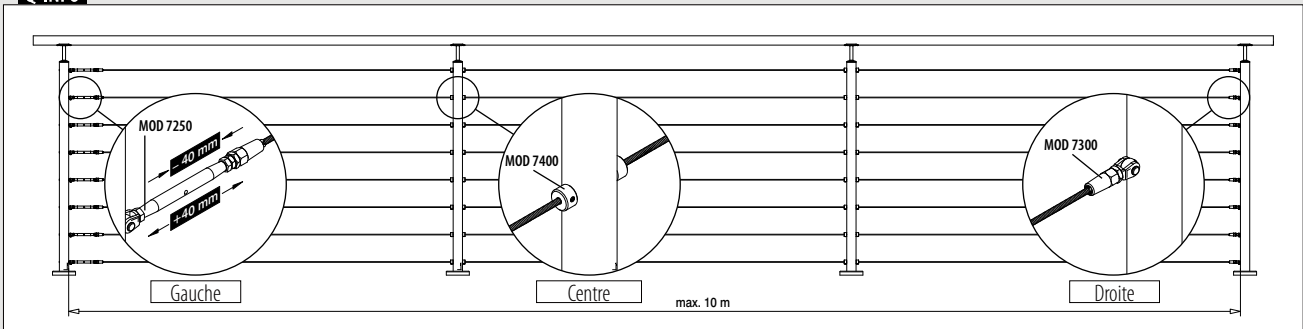

Entretoises pour câble pour installation en rampant

Pour tube plat

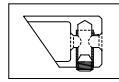
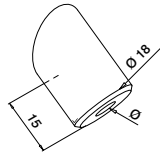

Ouverture basse

+/- 35°

Pour tube rond

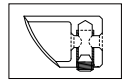
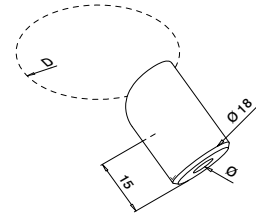

Ouverture basse

+/- 35°

MOD 7401

304 Inox brossé

INDOOR	Pour câble Ø	
137401-000-02	3,2	6

316 Inox brossé

OUTDOOR	Pour câble Ø	
147401-000-02	3,2	6



MOD 7401

304 Inox brossé

INDOOR	D	Pour câble Ø	
137401-042-02	42,4	3,2	6

316 Inox brossé

OUTDOOR	D	Pour câble Ø	
147401-042-02	42,4	3,2	6



Pour tube plat

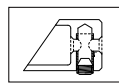
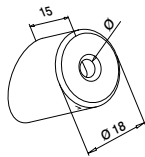

Ouverture haute

+/- 35°

Pour tube rond

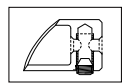
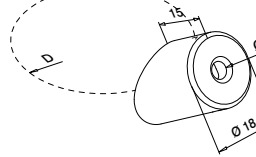

Ouverture haute

+/- 35°

MOD 7401

304 Inox brossé

INDOOR	Pour câble Ø	
137401-000-01	3,2	6

316 Inox brossé

OUTDOOR	Pour câble Ø	
147401-000-01	3,2	6



MOD 7401

304 Inox brossé

INDOOR	D	Pour câble Ø	
137401-042-01	42,4	3,2	6

316 Inox brossé

OUTDOOR	D	Pour câble Ø	
147401-042-01	42,4	3,2	6



Q-INFO | MOD 7250 / 7401-042 / 7300

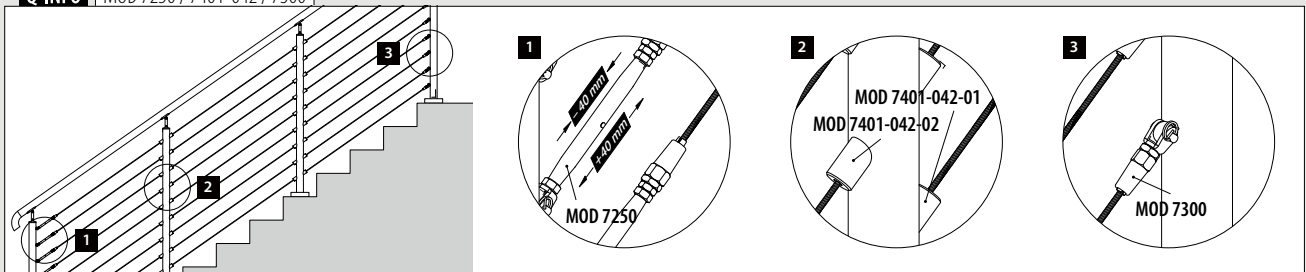

Supports traversant pour câble

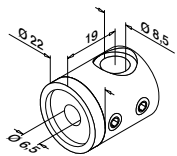

Pour tube plat
Gauche

MOD 7450

304		Inox brossé	
INDOOR			
137450-000-01	QS-15	472	4

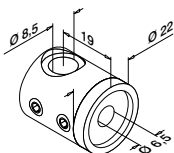

Pour tube plat
Droite

MOD 7450

304		Inox brossé	
INDOOR			
137450-000-02	QS-15	472	4

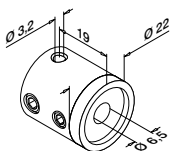

Pour tube plat
Centre

MOD 7450

304		Inox brossé	
INDOOR			
137450-000-00	QS-15	472	4

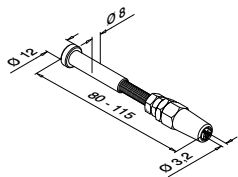

MOD 7500

304		Inox brossé	
INDOOR			
137500			4
316		Inox brossé	
OUTDOOR			
147500			4

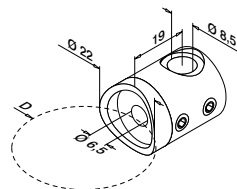

Pour tube rond
Gauche

MOD 7450

304		Inox brossé	
INDOOR			
137450-042-01	D	42,4	4



316		Inox brossé	
OUTDOOR			
147450-042-01	D	42,4	4

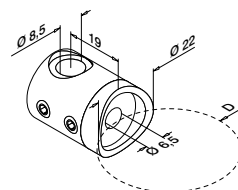

Pour tube rond
Droite

MOD 7450

304		Inox brossé	
INDOOR			
137450-042-02	D	42,4	4



316		Inox brossé	
OUTDOOR			
147450-042-02	D	42,4	4

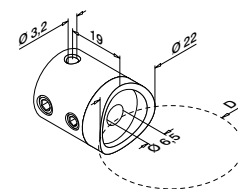

Pour tube rond
Centre

MOD 7450

304		Inox brossé	
INDOOR			
137450-042-00	D	42,4	4



316		Inox brossé	
OUTDOOR			
147450-042-00	D	42,4	4



Q-INFO | MOD 7450 / 7500 / 7900

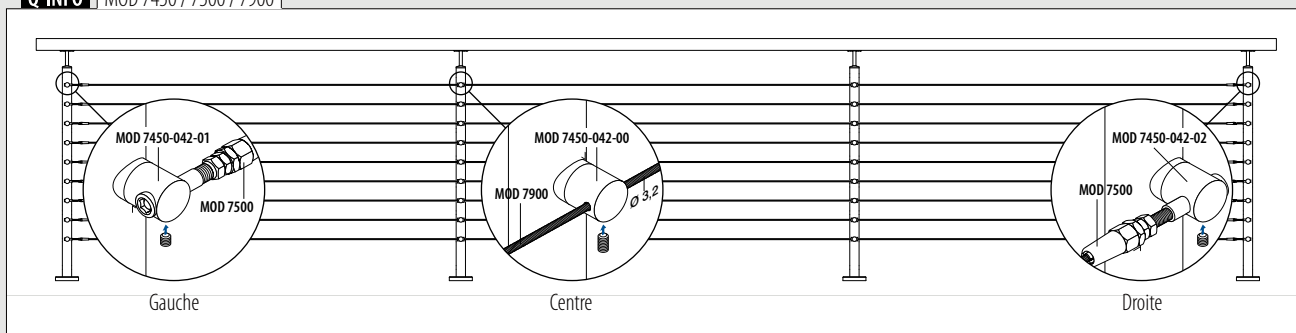



Retrouvez toutes les informations sur le remplissage par filet en ligne :



<https://q-ne.ws/QWeb23>

REMPLISSAGE - FILET

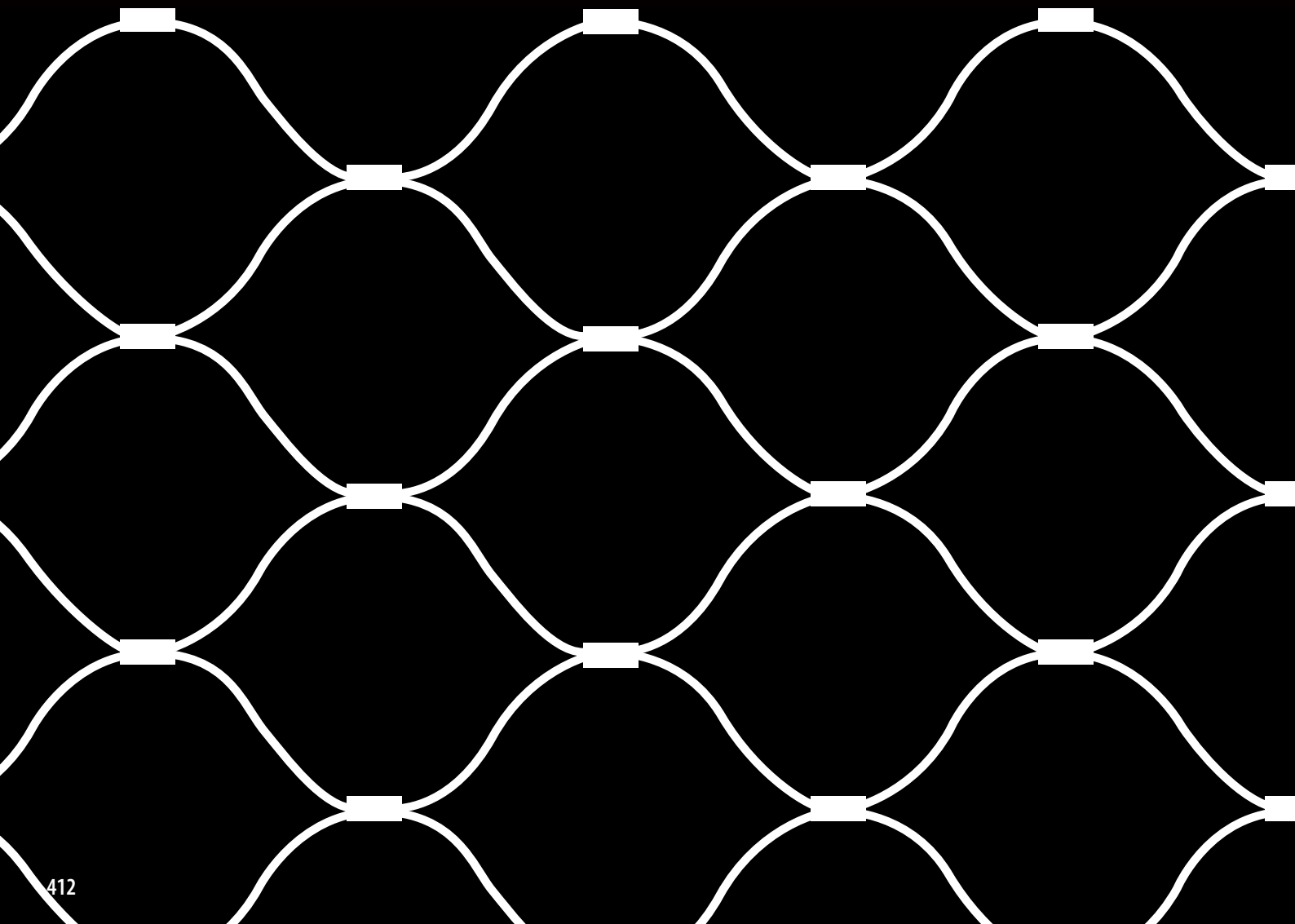

Remplissage

Câbles

 $\varnothing 6,0 \text{ mm} = \text{7 x 19}$

MOD 7900

316	Inox brossé		
OUTDOOR		\varnothing	
147900-006-10	6,0	L = 10 m	
147900-006-50	6,0	L = 50 m	
147900-006-01	6,0	L = 100 m	

Remplissage

Tendeurs



MOD 7260

316	Inox brossé			
OUTDOOR		\varnothing	H	L
147260-006	6	125	340-360	2

Remplissage

Adaptateurs

Pour tube plat

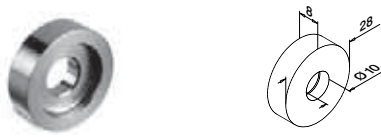

MOD 7723

316	Inox brossé	
OUTDOOR		
147723-000	12	

Pour tube rond

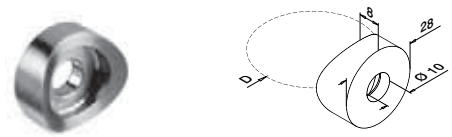

MOD 7723

316	Inox brossé	
OUTDOOR		D
147723-042	42,4	12
147723-048	48,3	12

Remplissage

Supports de fixation pour câble

Pour tube rond

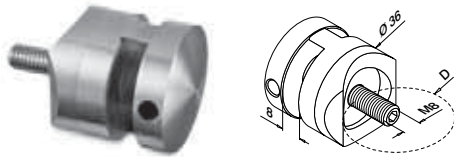

MOD 7356

316	Inox brossé	
OUTDOOR		D
147356-042	42,4	2



Remplissage

Vis à œillet

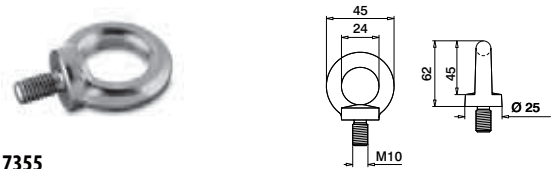

MOD 7355

316	Inox brossé	
OUTDOOR		
147355-010	12	

Accessoires

Attache-câble



MOD 1050

Accessoires	Q	L	
201050	Q-50	300	100

Q-INFO MOD 7900-006

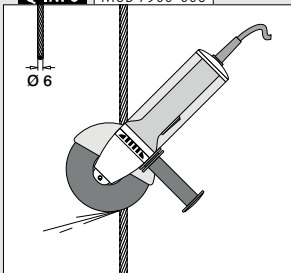

Q-INFO MOD 7356-042

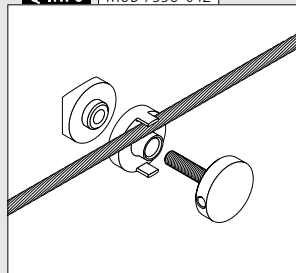

Q-INFO MOD 7355 / 7723

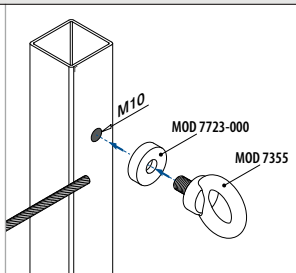
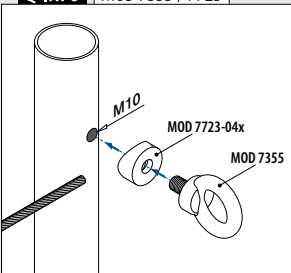

Remplissage

Filets

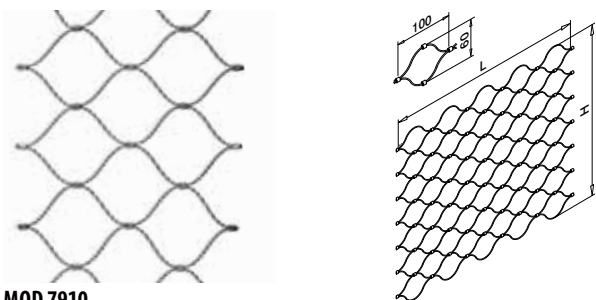

MOD 7910

316 Inox brossé		
OUTDOOR	H	
147910-050-06	600	L = 5 m
147910-100-06	600	L = 10 m
147910-500-06	600	L = 50 m
147910-050-08	800	L = 5 m
147910-100-08	800	L = 10 m
147910-500-08	800	L = 50 m

Remplissage

Câbles

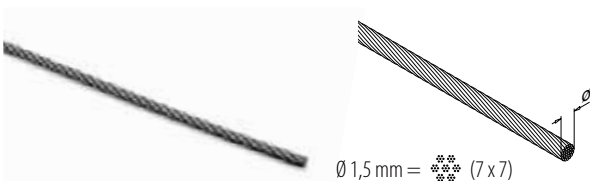

MOD 7911

316 Inox brossé		
OUTDOOR	Ø	
147911-100	1,5	L = 10 m
147911-500	1,5	L = 50 m
147911-001	1,5	L = 100 m

Remplissage

Tendeur vertical

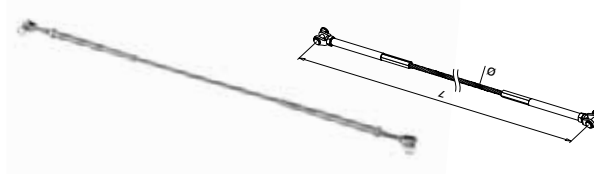

MOD 7780

316 Inox brossé			
OUTDOOR	Ø	L	
147780	8	800	1

Remplissage

Serre filet

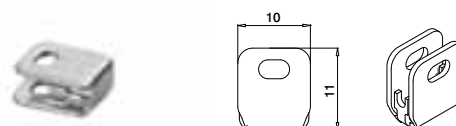

MOD 7810

316 Inox brossé	
OUTDOOR	
147810	12

Remplissage

Serre câble



MOD 7820

316 Inox brossé	
OUTDOOR	
147820	12

International Design Modèle Protection

Remplissage

Raccords



MOD 7830

316 Inox brossé	
OUTDOOR	
147830	12

Q-INFO | MOD 7260 / 7810 / 7820

Nombre de pièces nécessaires

MOD 7260		1 pièce tous les 10 mètres
MOD 7810		20 pièces tous les mètres: 2 x 10 pièces (haut et bas compris)
MOD 7820	H = 600 mm	10 pièces de chaque côté (droit et gauche)
	H = 800 mm	13 pièces de chaque côté (droit et gauche)





Retrouvez toutes les
informations sur le remplissage
par panneaux de tôle en ligne :



q-ne.ws/lnfills23

PIÈCES POUR REEMPLISSAGE - PANNEAUX DE TÔLE

Pincès à tôle - MOD 2800

Pour tube plat

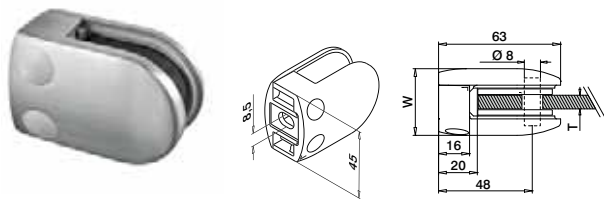

MOD 2800

304	Inox brossé				
INDOOR	W	T			
132800-000-12	34	Voir MOD 5028	QS-26	474	4

304	Poli miroir				
INDOOR					
132800-000-10	34	Voir MOD 5028	QS-26	474	4

SELL OUT

316	Inox brossé				
OUTDOOR					
142800-000-12	34	Voir MOD 5028	QS-27	474	4

316	Poli miroir				
OUTDOOR					
142800-000-10	34	Voir MOD 5028	QS-27	474	4

316	Black Line				
OUTDOOR					
142800-000-82	34	Voir MOD 5028	QS-27	474	4

NEW

Zamak					
INDOOR					
102800-000-...	36	Voir MOD 5028	QS-28	474	4

SELL OUT



International Design Modèle Protection

Pour tube rond

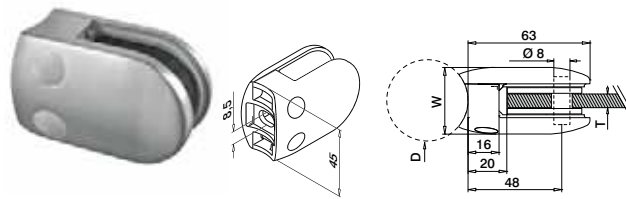

MOD 2800

304	Inox brossé				
INDOOR	D	W	T		
132800-042-12	42,4	34	Voir MOD 5028	QS-47	474 4
132800-048-12	48,3	34	Voir MOD 5028	QS-47	474 4

304	Poli miroir				
INDOOR					
132800-042-10	42,4	34	Voir MOD 5028	QS-47	474 4
132800-048-10	48,3	34	Voir MOD 5028	QS-47	474 4

SELL OUT

SELL OUT

316	Inox brossé				
OUTDOOR					
142800-042-12	42,4	34	Voir MOD 5028	QS-45	474 4
142800-048-12	48,3	34	Voir MOD 5028	QS-45	474 4

316	Poli miroir				
OUTDOOR					
142800-042-10	42,4	34	Voir MOD 5028	QS-45	474 4
142800-048-10	42,4	34	Voir MOD 5028	QS-45	474 4

NEW

Zamak					
INDOOR					
102800-042-...	42,4	36	Voir MOD 5028	QS-46	474 4
102800-048-...	48,3	36	Voir MOD 5028	QS-46	474 4

SELL OUT

SELL OUT



International Design Modèle Protection

Cales caoutchouc pour pincès à tôle MOD 2800



2 pièces par pincès à tôle

MOD 5028

Accessoires	T	
205028-02	2	8
205028-03	3	8
205028-04	4	8

SELL OUT Seulement jusqu'à épuisement des stocks.

Commander séparément le matériel de fixation.

Q-INFO MOD 5015 / 2800

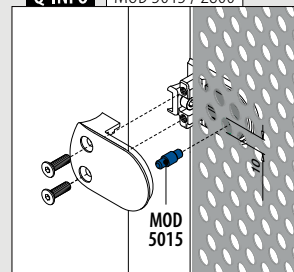

Q-INFO 304 316 MOD 2800 Finitions

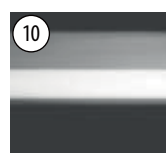

Poli miroir

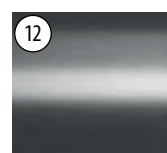

Inox brossé



Noir, mat, texture

Q-INFO Zamak MOD 2800 Finitions

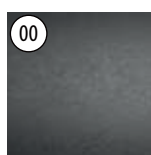

Brut

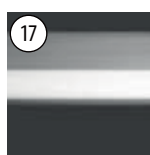

Chromé brillant



Aspect inox brossé



Noir, mat, texture



Noir, mat, uni



102800-000-00

102800-000-17

102800-000-19

102800-000-82

102800-000-89



102800-04x-00

102800-04x-17

102800-04x-19

102800-04x-82

102800-04x-89

Q-INFO



Une finition .00 est prête à être thermolaquée.

Pincès à tôle - MOD 4200

Pour tube plat

Entretoise de sécurité comprise

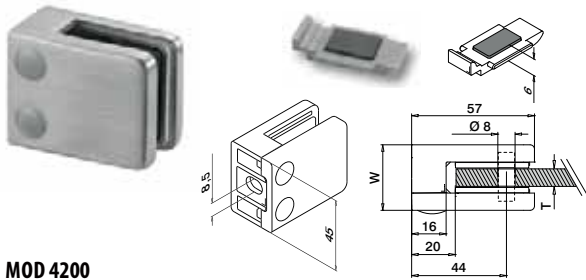

MOD 4200

304		Inox brossé					
INDOOR	W	T					
134200-000-12	28	Voir MOD 5042	QS-26	474	4		
316		Inox brossé					
OUTDOOR		144200-000-12	28	Voir MOD 5042	QS-27	474	4
316		Black Line					
OUTDOOR		144200-000-82	28	Voir MOD 5042	QS-27	474	4
316		Poli miroir					
OUTDOOR		144200-000-10	28	Voir MOD 5042	QS-27	474	4
Zamak							
INDOOR		104200-000-...	30	Voir MOD 5042	QS-28	474	4

International Design
Modèle Protection

Pour tube rond

Entretoise de sécurité comprise

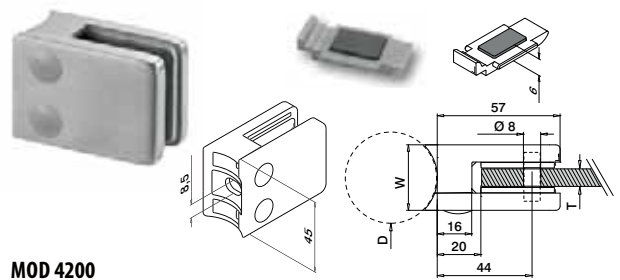

MOD 4200

304		Inox brossé					
INDOOR	D	W	T				
134200-042-12	42,4	28	Voir MOD 5042	QS-47	474	4	
134200-048-12	48,3	28	Voir MOD 5042	QS-47	474	4	
304		Black Line					
INDOOR		134200-042-82	42,4	28	Voir MOD 5042	QS-47	474
316		Inox brossé					
OUTDOOR		144200-042-12	42,4	28	Voir MOD 5042	QS-45	474
144200-048-12	48,3	28	Voir MOD 5042	QS-45	474	4	
316		Poli miroir					
OUTDOOR		144200-042-10	42,4	28	Voir MOD 5042	QS-45	474
144200-048-10	48,3	28	Voir MOD 5042	QS-45	474	4	
Zamak							
INDOOR		104200-042-...	42,4	30	Voir MOD 5042	QS-46	474
104200-048-...	48,3	30	Voir MOD 5042	QS-46	474	4	

International Design
Modèle Protection

Q-INFO 304 316 MOD 4200 Finitions

10

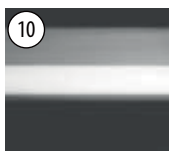

Poli miroir

12

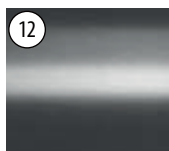

Inox brossé

82 RAL 9005

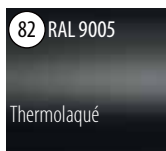
Noir, mat,
texture

Q-INFO

00

Une finition .00 est prête
à être thermolaquée.

Q-INFO MOD 5015 / 4200

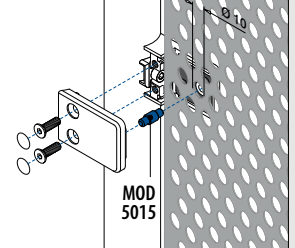

Q-INFO Zamak MOD 4200 Finitions

00



Brut

17



Chromé brillant

19

Aspect inox
brossé

32 RAL 9016

Blanc, brillant de
soie, uni

33 RAL 7016

Gris anthracite,
mat, texture

36 RAL 9006

Aluminium
blanc, brillant de
soie, uni

82 RAL 9005

Noir, mat,
texture

89 RAL 9005



Noir, mat, uni



104200-000-00

104200-000-17

104200-000-19

104200-000-32

104200-000-33

104200-000-36

104200-000-82

104200-000-89



104200-04x-00

104200-04x-19

104200-042-82

104200-042-89

Cales caoutchouc pour pinces à tôle MOD 4200

2 pièces par
pince à tôle

MOD 5042

Accessoires		
	T	
205042-02	2	8
205042-03	3	8
205042-04	4	8

Goupilles de sécurité

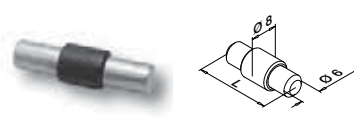
Optionnel pour
MOD 4200

MOD 5015

Accessoires		
	L	
205015-22	22	4

Pincés à tôle - MOD 0743

Pour tube plat

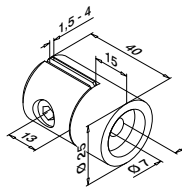

MOD 0743

304 Inox brossé		
INDOOR		
130743-000	QS-17 472	4



Pour tube rond

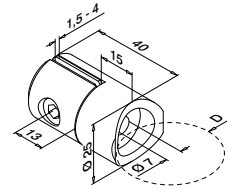

MOD 0743

304 Inox brossé		
INDOOR	D	
130743-042	42,4	QS-17 472 4
130743-048	48,3	QS-17 472 4





5

SUPPORTS DE REMPLISSAGE EN VERRE

Trouvez votre fixation pour verre423 - 430

Pinces à verre430 - 442

Supports de verre444 - 445

Pinces de liaison446 - 448

Charnières et loquets448 - 449

Adaptateurs à verre451 - 453



SUPPORTS DE VERRE

▣ 444 - 445



Retrouvez toutes les informations sur pincés à verre en ligne :



<https://q-ne.ws/GlassClamps23>



PINCES À VERRE

▣ 430 - 442

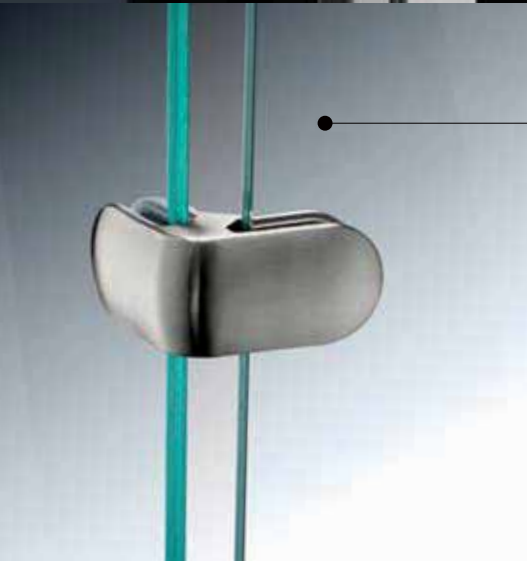

PINCES DE LIAISON

▣ 446 - 448

ADAPTATEURS À VERRE

▣ 451 - 453



CHARNIÈRES ET LOQUETS

▣ 448 - 449



TRANSPARENCE CRISTALLINE ET SÉCURITÉ ABSOLUE

Ne vous fiez pas à sa fragilité apparente, le verre est un matériau extrêmement solide et donc un excellent choix pour habiller vos garde-corps. Et en l'associant aux supports de remplissage en verre hautement résistants de Q-railing, vous obtiendrez un garde-corps pratiquement indestructible. Et nous le savons par expérience ! Dans notre centre de test, nos produits sont soumis en permanence à des essais rigoureux. Ils font également l'objet de contrôles approfondis de la part d'autorités de premier plan et d'organismes indépendants et certifiés.

Nos pinces à verre, qui sont testées conformément à la norme européenne EN-12600, peuvent donc supporter des charges dynamiques allant jusqu'à 50 kg, que vous choisissiez de les associer à du verre feuilleté trempé ou à du verre monolithique (6 - 21,52 mm). Ces deux options sont certifiées DIN et BS, ainsi que AbZ pour l'Allemagne.

CERTIFICATION

Nos pinces à verre ont été testées conformément à la norme DIN/EN 12600 et sont donc certifiées AbZ pour l'Allemagne.

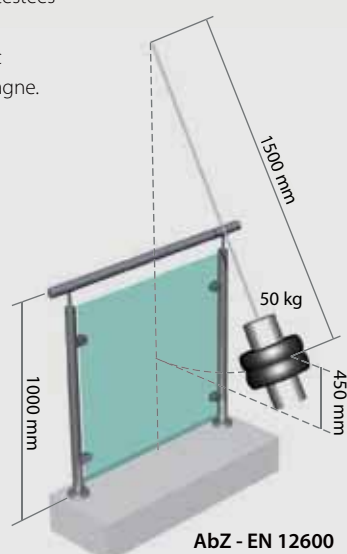
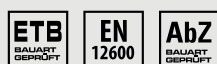

SÉCURITÉ

Fixation latérale ? La sécurité avant tout.

Utilisez des goupilles de sécurité ou pattes de blocage.



(MOD 5015)



(Inclus dans MOD 2300, 2400, 2600, 4200)

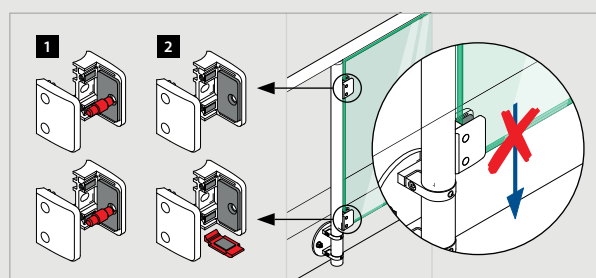

Configuration de test

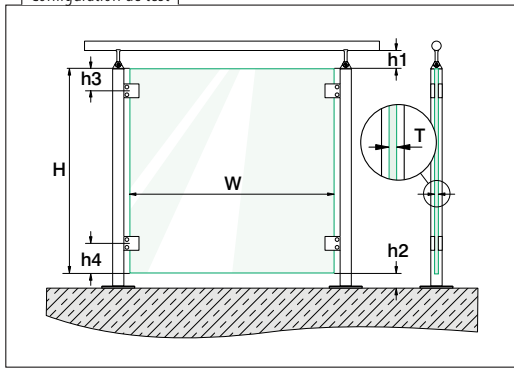

Dimensions (mm)	min.	max.
W Largeur du verre	500	Voir le modèle
T Épaisseur du verre	Voir le modèle	Voir le modèle
H Hauteur du verre	800	1000
h1 Écart main-courante/verre	10	50 sans profil de protection, 120 avec profil de protection
h2 Écart sol/verre	10	50 sans profil de protection, 120 avec profil de protection
h3 Écart haut du verre / axe pince supérieure	100 : MOD 2500, 2100, 2600, 2400 50 : MOD 2800 120 : MOD 4200	150
h4 Écart bas du verre / axe pince inférieure	100 : MOD 2500, 2100, 2600, 2400 50 : MOD 2800 120 : MOD 4200	150

INDOOR

Pincès à verre sans goupille de sécurité ni patte de blocage.

MOD 2700

304

Zamak

Plat ou tube
Ø 33,7 mm
Ø 42,4 mm

Type de verre

Type de verre	Mono / ESG-H*
T (mm)	8
W _{max} (mm)	1200

MOD 2500

304

Zamak

Plat ou tube
Ø 42,4 mm
Ø 48,3 mm

Type de verre

Type de verre	VSG / TVG*					VSG / ESG*					Mono / ESG-H*		
T (mm)	8,76	9,52	10,76	11,52	12,76	8,76	9,52	10,76	11,52	12,76	8	10	12
W _{max} (mm)	1500	1500	1500	1500	1500	1500	1500	1500	1500	1500	1500	1500	1500

MOD 2800

304

Zamak

Plat ou tube
Ø 48,3 mm

Type de verre

Type de verre	VSG / SPG*	VSG / TVG*					VSG / ESG*					Mono / ESG-H*		
T (mm)	12,76	8,76	9,52	10,76	11,52	12,76	8,76	9,52	10,76	11,52	12,76	8	10	12
W _{max} (mm)	1500	1800	1800	1800	1800	1800	1800	1800	1800	1800	2000	1800	1800	1800

MOD 2100

304

Zamak

Plat ou tube
Ø 42,4 mm

Type de verre

Type de verre	VSG / ESG*										
T (mm)	8,76					9,52					
W _{max} (mm)	1200					1200					

MOD 4200

304

Zamak

Plat ou tube
Ø 42,4 mm
Ø 48,3 mm

Type de verre

Type de verre	VSG / SPG*	VSG / TVG*				VSG / ESG*				Mono / ESG-H*			
T (mm)	12,76	10,76	11,52	12,76	8,76	9,52	10,76	11,52	12,76	8	10	12	
W _{max} (mm)	1600	1600	1600	1600	1800	1800	1800	1800	1800	1800 ¹ 2000 ²	1800	1800	1800

¹ Zamak ² Inox 304

MOD 2600

304

Zamak

Plat ou tube
Ø 42,4 mm
Ø 48,3 mm

Type de verre

Type de verre	VSG / TVG*				VSG / ESG*				Mono / ESG-H*		
T (mm)	8,76	10,76	11,52	12,76	8,76	10,76	11,52	12,76	8	10	12
W _{max} (mm)	1400	1600	1600	1600	1400	1600	1600	1600	1400	1600	1600

MOD 2400

304

Zamak

Plat ou tube
Ø 48,3 mm

Type de verre

Type de verre	VSG / SPG*				VSG / TVG*				VSG / ESG*				Mono / ESG-H*	
T (mm)	12,76	13,52	16,76	17,52	12,76	13,52	16,76	17,52	12,76	13,52	16,76	17,52	12	15
W _{max} (mm)	1500	1500	1500	1500	1500	1500	1500	1500	1600	1600	1600	1600	1600	1600



OUTDOOR

Dimensions et types de verre en fonction de la force du vent.
Pincès à verre sans goupille de sécurité ni patte de blocage.

MOD 2500

316



Plat ou tube
Ø 42,4 mm
Ø 48,3 mm

Pression du vent	Type de verre T (mm)	VSG / TVG*		VSG / ESG*		Mono / ESG-H*	
		8,76	9,52	10,76	12,76	8	10
2,20 kN/m ²	W _{max} (mm)	-	-	-	-	800	800
1,60 kN/m ²		-	-	500	500	1000	1400
1,40 kN/m ²		-	-	500	500	1000	1400
1,04 kN/m ²		500	500	800	800	1400	1500
1,00 kN/m ²		500	500	1000	1000	1400	1500
0,64 kN/m ²		800	800	1200	1200	1500	1500

MOD 2800 / 4200

316



Plat ou tube
Ø 42,4 mm
Ø 48,3 mm



Plat ou tube
Ø 42,4 mm
Ø 48,3 mm

Pression du vent	Type de verre T (mm)	VSG / SPG*			VSG / TVG*			VSG / ESG*				Mono / ESG-H*			
		12,76	8,76	9,52	10,76	11,52	12,76	8,76	9,52	10,76	11,52	12,76	8	10	12
2,20 kN/m ²	W _{max} (mm)	-	-	-	700	700	950	650	650	950	950	1100	1000	1500	1700
2,00 kN/m ²		-	-	-	700	700	1000	700	700	1000	1000	1200	1050	1600	1800
1,60 kN/m ²		-	-	-	800	800	1100	800	800	1100	1100	1200	1200	1600	1800
1,40 kN/m ²		-	600	600	900	900	1300	850	850	1200	1200	1400	1250	1600	1800
1,04 kN/m ²		-	700	700	1050	1050	1300	1000	1000	1300	1300	1400	1500	1700	1800
1,00 kN/m ²		-	700	700	1050	1050	1300	1000	1000	1300	1300	1400	1500	1700	1800
0,70 kN/m ²		-	900	900	1050	1050	1400	1100	1100	1400	1400	1500	1550	1700	1800

MOD 2600

316



Plat ou tube
Ø 42,4 mm
Ø 48,3 mm

Pression du vent	Type de verre T (mm)	VSG / TVG*				VSG / ESG*				Mono / ESG-H*		
		8,76	10,76	11,52	12,76	8,76	10,76	11,52	12,76	8	10	12
2,20 kN/m ²	W _{max} (mm)	-	-	-	500	500	800	800	800	800	1000	1400
1,60 kN/m ²		-	500	500	800	800	800	800	1000	1000	1400	1400
1,40 kN/m ²		-	800	800	800	800	1000	1000	1200	1200	1400	1400
1,04 kN/m ²		500	800	800	1000	800	1000	1000	1400	1400	1400	1400
1,00 kN/m ²		500	800	800	1000	800	1200	1200	1400	1400	1400	1400
0,64 kN/m ²		800	1000	1000	1200	1200	1400	1400	1400	1400	1400	1400

MOD 2400

316



Plat ou tube
Ø 48,3 mm

Pression du vent	Type de verre T (mm)	VSG / SPG*				VSG / TVG*				VSG / ESG*				Mono / ESG-H*	
		12,76	13,52	16,76	17,52	12,76	13,52	16,76	17,52	12,76	13,52	16,76	17,52	12	16
2,20 kN/m ²	W _{max} (mm)	500	500	800	800	500	500	1000	1000	500	500	1000	1000	1400	1600
1,60 kN/m ²		500	500	1000	1000	800	800	1200	1200	800	800	1200	1200	1500	1600
1,40 kN/m ²		800	800	1000	1000	800	800	1200	1200	800	800	1400	1400	1600	1600
1,04 kN/m ²		800	800	1200	1200	1000	1000	1500	1500	1200	1200	1600	1600	1600	1600
1,00 kN/m ²		1000	1000	1200	1200	1000	1000	1500	1500	1200	1200	1600	1600	1600	1600
0,64 kN/m ²		1200	1200	1500	1500	1500	1500	1500	1500	1500	1500	1600	1600	1600	1600

* VSG: Verre de sécurité feuilleté
Mono: Verre monocouche

SPG: Verre "float"
TVG: Verre durci

ESG: Verre trempé
ESG-H: Verre trempé approuvé par un test thermique de détection de défaut (Heat Soak Test)

Configuration de test

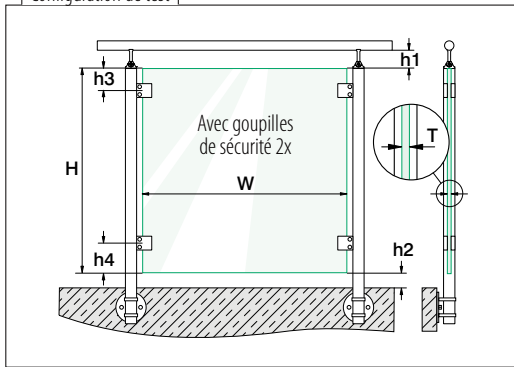

Dimensions (mm)		min.	max.
W	Largeur du verre	500	Voir le modèle
T	Épaisseur du verre	Voir le modèle	Voir le modèle
H	Hauteur du verre	800	1000
h1	Écart main-courante/verre	10	50 sans profil de protection, 120 avec profil de protection
h2	Écart sol/verre	10	50 sans profil de protection, 120 avec profil de protection
h3	Écart haut du verre / axe pince supérieure	150 : MOD 2500 / MOD 2400 50 : MOD 2800 120 : MOD 4200	150
h4	Écart bas du verre / axe pince inférieure	150 : MOD 2500 / MOD 2400 50 : MOD 2800 120 : MOD 4200	150

INDOOR

Pincès à verre avec goupille de sécurité, sans patte de blocage.

MOD 2500

304

Zamak

Plat ou tube
Ø 42,4 mm
Ø 48,3 mm

Type de verre	VSG / ESG*
T (mm)	12,76
W _{max} (mm)	1600

MOD 2800

304

Zamak

Plat ou tube
Ø 42,4 mm
Ø 48,3 mm

Type de verre	VSG / TVG*					VSG / ESG*					Mono / ESG-H*		
	8,76	9,52	10,76	11,52	12,76	8,76	9,52	10,76	11,52	12,76	8	10	12
T (mm)	8,76	9,52	10,76	11,52	12,76	8,76	9,52	10,76	11,52	12,76	8	10	12
W _{max} (mm)	1800	1800	1800	1800	1800	1800	1800	1800	1800	1800	1800	1800	1800

MOD 4200

304

Zamak

Plat ou tube
Ø 42,4 mm
Ø 48,3 mm

Type de verre	VSG / SPG*		VSG / TVG*			VSG / ESG*					Mono / ESG-H*			
	12,76	10,76	11,52	12,76	8,76	9,52	10,76	11,52	12,76	1800 ¹	2000 ²	8	10	12
T (mm)	12,76	10,76	11,52	12,76	8,76	9,52	10,76	11,52	12,76	1800 ¹	2000 ²	8	10	12
W _{max} (mm)	1500	1600	1600	1600	1800	1800	1800	1800	1800	1800	1800	1800	1800	1800

¹Zamak ²Inox 304

MOD 2400

304

Zamak

Plat ou tube
Ø 48,3 mm

Type de verre	VSG / ESG*				Mono / ESG-H*	
	12,76	13,52	16,76	17,52	12	15
T (mm)	12,76	13,52	16,76	17,52	12	15
W _{max} (mm)	1600	1600	1600	1600	1600	1600

* VSG: Verre de sécurité feuilleté
Mono: Verre monocoucheSPG: Verre "float"
TVG: Verre durciESG: Verre trempé
ESG-H: Verre trempé approuvé par un test thermique de
détection de défaut (Heat Soak Test)



OUTDOOR



Dimensions et types de verre en fonction de la force du vent.
Pincès à verre avec goupille de sécurité, sans patte de blocage.

MOD 2500

316



Plat ou tube
Ø 42,4 mm
Ø 48,3 mm

Pression du vent	Type de verre T (mm)	VSG / ESG*	
		12,76	1100
2,20 kN/m ²	W _{max} (mm)	1200	1200
2,00 kN/m ²		1400	1400
1,60 kN/m ²		1400	1400
1,40 kN/m ²		1400	1400
1,04 kN/m ²		1400	1500
1,00 kN/m ²			
0,70 kN/m ²			

MOD 2800 / 4200

316



Plat ou tube
Ø 42,4 mm
Ø 48,3 mm



Plat ou tube
Ø 42,4 mm
Ø 48,3 mm

Pression du vent	Type de verre T (mm)	VSG / TVG*					VSG / ESG*					Mono / ESG-H*		
		8,76	9,52	10,76	11,52	12,76	8,76	9,52	10,76	11,52	12,76	8	10	12
2,20 kN/m ²	W _{max} (mm)	-	-	700	700	950	650	650	950	950	1100	1000	1500	1700
2,00 kN/m ²		-	-	700	700	1000	700	700	1000	1000	1200	1050	1600	1800
1,60 kN/m ²		-	-	800	800	1100	800	800	1100	1100	1200	1200	1600	1800
1,40 kN/m ²		600	600	900	900	1300	850	850	1200	1200	1400	1250	1600	1800
1,04 kN/m ²		700	700	1050	1050	1300	1000	1000	1300	1300	1400	1500	1700	1800
1,00 kN/m ²		700	700	1050	1050	1300	1000	1000	1300	1300	1400	1500	1700	1800
0,70 kN/m ²		900	900	1050	1050	1400	1100	1100	1400	1400	1500	1550	1700	1800

MOD 2400

316



Plat ou tube
Ø 48,3 mm

Pression du vent	Type de verre T (mm)	VSG / ESG*				Mono / ESG-H*	
		12,76	13,52	16,76	17,52	12	15
2,20 kN/m ²	W _{max} (mm)	500	500	1000	1000	1400	1600
1,60 kN/m ²		800	800	1200	1200	1500	1600
1,40 kN/m ²		800	800	1400	1400	1600	1600
1,04 kN/m ²		1200	1200	1600	1600	1600	1600
1,00 kN/m ²		1200	1200	1600	1600	1600	1600
0,64 kN/m ²		1500	1500	1600	1600	1600	1600

Configuration de test

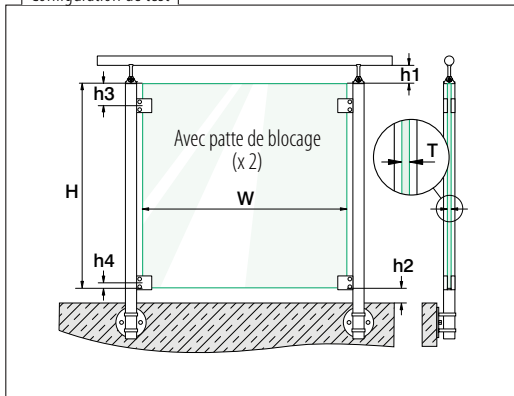

Dimensions (mm)		min.	max.
W	Largeur du verre	500	Voir le modèle
T	Épaisseur du verre	Voir le modèle	Voir le modèle
H	Hauteur du verre	800	1000
h1	Écart main-courante/verre	10	50 sans profil de protection, 120 avec profil de protection
h2	Écart sol/verre	10	50 sans profil de protection, 120 avec profil de protection
h3	Écart haut du verre / axe pince supérieure	100 : MOD 2600, 2400 120 : MOD 4200	150
h4	Écart bas du verre / axe pince inférieure	29 : MOD 2400 22 : MOD 2600 16,5 : MOD 4200	29 : MOD 2400 22 : MOD 2600 16,5 : MOD 4200

INDOOR

Pincès à verres sans goupille de sécurité, avec patte de blocage.

MOD 4200

304

Zamak

Plat ou tube
Ø 42,4 mm
Ø 48,3 mm

Type de verre	VSG / SPG*	VSG / TVG*				VSG / ESG*				Mono / ESG-H*		
T (mm)	12,76	10,76	11,52	12,76	8,76	9,52	10,76	11,52	12,76	8	10	12
W _{max} (mm)	1600	1600	1600	1600	1800	1800	1800	1800	1800 ¹ 2000 ²	1800	1800	1800

¹Zamak ²Inox 304

MOD 2600

304

Plat ou tube
Ø 42,4 mm
Ø 48,3 mm

Type de verre	VSG / ESG*				Mono / ESG-H*		
T (mm)	8,76	10,76	11,52	12,76	8	10	12
W _{max} (mm)	1400	1400	1400	1400	1400	1400	1400

MOD 2400

304

Zamak

Plat ou tube
Ø 48,3 mm

Type de verre	VSG / TVG*				VSG / ESG*				Mono / ESG-H*	
T (mm)	12,76	13,52	16,76	17,52	12,76	13,52	16,76	17,52	12	15
W _{max} (mm)	1500	1500	1500	1500	1600	1600	1600	1600	1600	1600

* VSG: Verre de sécurité feuilleté
Mono: Verre monocoucheSPG: Verre "float"
TVG: Verre durciESG: Verre trempé
ESG-H: Verre trempé approuvé par un test thermique de
détection de défaut (Heat Soak Test)



OUTDOOR



Dimensions et types de verre en fonction de la force du vent.
Pincès à verre sans goupille de sécurité, avec patte de blocage.

MOD 4200

316



Plat ou tube
Ø 42,4 mm
Ø 48,3 mm

Pression du vent	Type de verre T (mm)	VSG / TVG*					VSG / ESG*					Mono / ESG-H*		
		8,76	9,52	10,76	11,52	12,76	8,76	9,52	10,76	11,52	12,76	8	10	12
2,20 kN/m ²	W _{max} (mm)	-	-	700	700	1000	650	650	950	950	1100	1000	1500	1700
2,00 kN/m ²		-	-	750	750	1050	700	700	1000	1000	1300	1050	1600	1800
1,60 kN/m ²		-	-	850	850	1200	800	800	1100	1100	1300	1200	1600	1800
1,40 kN/m ²		600	600	950	950	1300	850	850	1200	1200	1500	1250	1600	1800
1,04 kN/m ²		700	700	1100	1100	1300	1000	1000	1400	1400	1500	1500	1700	1800
1,00 kN/m ²		700	700	1100	1100	1300	1000	1000	1400	1400	1500	1500	1700	1800
0,70 kN/m ²		900	900	1100	1100	1400	1050	1050	1500	1500	1600	1550	1700	1800

MOD 2600

316



Plat ou tube
Ø 42,4 mm
Ø 48,3 mm

Pression du vent	Type de verre T (mm)	VSG / ESG*				Mono / ESG-H*		
		8,76	10,76	11,52	12,76	8	10	12
2,20 kN/m ²	W _{max} (mm)	500	800	800	800	800	1000	1400
1,60 kN/m ²		800	800	800	1000	1000	1400	1400
1,40 kN/m ²		800	1000	1000	1200	1200	1400	1400
1,04 kN/m ²		800	1000	1000	1400	1400	1400	1400
1,00 kN/m ²		800	1200	1200	1400	1400	1400	1400
0,64 kN/m ²		1200	1400	1400	1400	1400	1400	1400

MOD 2400

316



Plat ou tube
Ø 48,3 mm

Pression du vent	Type de verre T (mm)	VSG / TVG*				VSG / ESG*				Mono / ESG-H*	
		12,76	13,52	16,76	17,52	12,76	13,52	16,76	17,52	12	15
2,20 kN/m ²	W _{max} (mm)	500	500	500	500	500	500	1000	1000	1400	1600
1,60 kN/m ²		500	500	800	800	800	800	1200	1200	1500	1600
1,40 kN/m ²		500	500	1000	1000	800	800	1400	1400	1600	1600
1,04 kN/m ²		800	800	1200	1200	1200	1200	1500	1500	1600	1600
1,00 kN/m ²		800	800	1200	1200	1200	1200	1500	1500	1600	1600
0,64 kN/m ²		1500	1500	1500	1500	1500	1500	1600	1600	1600	1600

SUPPORTS DE REMPLISSAGE EN VERRE – ÉPAISSEURS DE VERRE

	Verre monolithique						Verre feuilleté														
	Épaisseur du verre (mm)	6	8	10	12	15	19	Épaisseur du verre (mm)													
		6	8	10	12	15	19	6,76	8,38	8,76	9,52	10,76	11,52	12,76	13,52	16,76	17,52	20,76	21,52	25,52	
Pincés à verre	MOD 2700	431	■	■	■			■		■		■									
	MOD 2500	432	■	■	■	■		■		■	■	■	■	■							
	MOD 2800	433	■	■	■	■				■	■	■	■	■							
	MOD 4200	434 - 435	■	■	■	■		■	■	■	■	■	■	■							
	MOD 2100	436	■	■	■			■		■	■										
	MOD 2600	437		■	■	■				■		■	■	■							
	MOD 2400	438				■	■				■		■	■	■	■	■				
	MOD 2300	439				■	■	■			■		■	■	■	■	■	■	■	■	
	MOD 4400/4600	440		■	■					■		■									
	MOD 5100/5200	441		■	■					■		■									
	MOD 2900	442		■	■	■				■		■		■	■						
Supports de verre	MOD 5500	444		■	■	■				■		■	■	■	■						
	MOD 5501	445		■	■	■				■		■	■	■	■						
Pincés de liaison	MOD 2870/2880/2890	446	■	■	■	■				■	■	■	■	■		■	■	■	■	■	
	MOD 4270/4280/4290	447	■	■	■	■		■	■	■	■	■	■	■		■	■	■	■	■	
	MOD 0742	448					■	■						■	■	■	■	■	■		
Charnières et loquets	MOD 0283/0281	449	■	■	■	■		■	■	■	■	■	■	■							
	MOD 0284/0282	448	■	■	■	■		■	■	■	■	■	■	■							
Adaptateurs à verre	MOD 0754	451		■	■	■	■		■	■	■	■	■	■	■	■	■				
	MOD 0746	452	■	■	■	■	■	■	■	■	■	■	■	■	■	■	■				
	MOD 0740	452	■	■	■	■	■	■	■	■	■	■	■	■	■	■	■				
	MOD 0755	452	■	■	■	■		■	■	■	■	■	■	■	■	■	■				
	MOD 0747/1747	453		■	■	■	■		■	■	■	■	■	■	■	■	■	■	■	■	■

La gamme Q-railing propose des supports de remplissage en verre avec des finitions variées. Consultez les options et les codes associés pour les produits en zamak, acier inoxydable et aluminium à la page 7.

Pincès à verre - MOD 2700

Pour tube plat

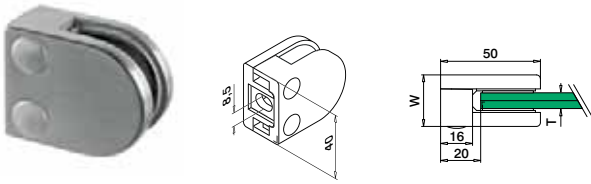

MOD 2700

304 Inox brossé

INDOOR	W	T		
132700-000-12	26	Voir MOD 5027	QS-26	474 4

316 Inox brossé

OUTDOOR	W	T		
142700-000-12	26	Voir MOD 5027	QS-27	474 4

Zamak

INDOOR

SELL OUT 102700-000-...	28	Voir MOD 5027	QS-28	474 4
-------------------------	----	---------------	-------	-------



Pour tube rond

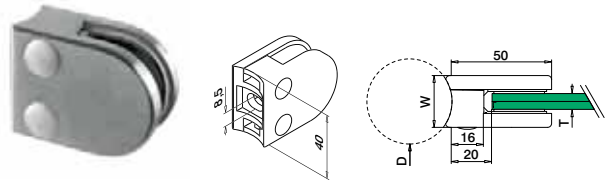

MOD 2700

304 Inox brossé

INDOOR	D	W	T		
132700-033-12	33,7	26	Voir MOD 5027	QS-47	474 4
132700-042-12	42,4	26	Voir MOD 5027	QS-47	474 4

316 Inox brossé

OUTDOOR	D	W	T		
142700-033-12	33,7	26	Voir MOD 5027	QS-45	474 4
142700-042-12	42,4	26	Voir MOD 5027	QS-45	474 4

Zamak

INDOOR

SELL OUT 102700-033-...	33,7	28	Voir MOD 5027	QS-46	474 4
SELL OUT 102700-042-...	42,4	28	Voir MOD 5027	QS-46	474 4



Cales caoutchouc pour MOD 2700

2 pièces par
pince à verre

MOD 5027

Accessoires

Pour verre monolithique	T	
205027-06	6	8
205027-08	8	8
205027-10	10	8

Pour verre feuilleté

205027-07	6,76	8
205027-09	8,76	8
205027-11	10,76	8

SELL OUT Seulement jusqu'à épuisement des stocks.

Commander séparément le matériel de fixation.

Q-INFO

Une finition .00 est prête
à être thermolaquée.

Q-INFO Zamak MOD 2700 Finitions

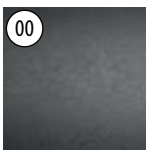

Brut



102700-000-00

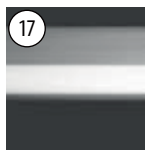

Chromé brillant

102700-000-17

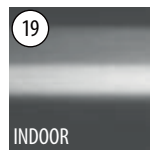

INDOOR

Aspect inox
brossé

102700-000-19



102700-0xx-19

Q-INFO MOD 1062

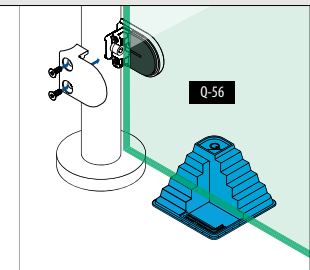
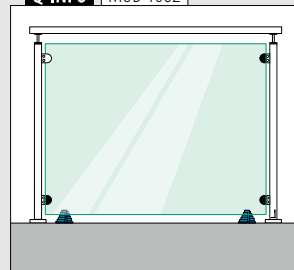

Pincès à verre - MOD 2500

Pour tube plat

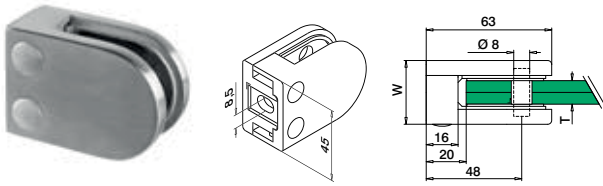

MOD 2500

304 Inox brossé

INDOOR	W	T		
132500-000-12	30	Voir MOD 5025	QS-26	474 4

316 Inox brossé

OUTDOOR	W	T		
142500-000-12	30	Voir MOD 5025	QS-27	474 4

316 Poli miroir

OUTDOOR	W	T		
142500-000-10	30	Voir MOD 5025	QS-27	474 4

316 Black Line

OUTDOOR	W	T		
142500-000-82	30	Voir MOD 5025	QS-27	474 4

Zamak

INDOOR

SELL OUT	W	T		
102500-000-...	32	Voir MOD 5025	QS-28	474 4



Pour tube rond

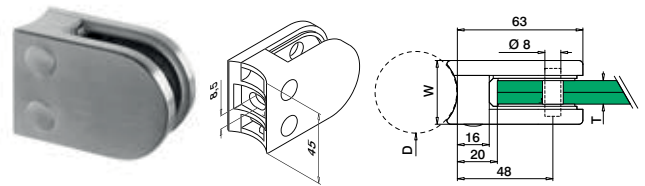

MOD 2500

304 Inox brossé

INDOOR	D	W	T		
132500-042-12	42,4	30	Voir MOD 5025	QS-47	474 4
132500-048-12	48,3	30	Voir MOD 5025	QS-47	474 4

316 Inox brossé

OUTDOOR	D	W	T		
142500-042-12	42,4	30	Voir MOD 5025	QS-45	474 4
142500-048-12	48,3	30	Voir MOD 5025	QS-45	474 4

316 Poli miroir

OUTDOOR	D	W	T		
142500-042-10	42,4	30	Voir MOD 5025	QS-45	474 4
142500-048-10	48,3	30	Voir MOD 5025	QS-45	474 4

Zamak

INDOOR

SELL OUT	D	W	T		
102500-042-...	42,4	32	Voir MOD 5025	QS-46	474 4
102500-048-...	48,3	32	Voir MOD 5025	QS-46	474 4



Cales caoutchouc pour MOD 2500



2 pièces par pince à verre

MOD 5025

Accessoires

Pour verre monolithique	T	
205025-06	6	8
205025-08	8	8
205025-10	10	8
205025-12	12	8

Pour verre feuilleté

205025-07	6,76	8
205025-09	8,76	8
205025-44	9,52	8
205025-11	10,76	8
205025-54	11,52	8
205025-13	12,76	8

Goupilles de sécurité

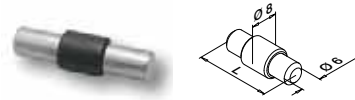

Optionnel pour MOD 2500

MOD 5015

Accessoires

	L	
205015-25	25	4

SELL OUT Seulement jusqu'à épuisement des stocks.

Q-INFO Zamak MOD 2500 Finitions

00	17	19	32 RAL 9016	82 RAL 9005	89 RAL 9005
Brut	Chromé brillant	Aspect inox brossé	Thermolaqué INDOOR Blanc, brillant de soie, uni	Thermolaqué Noir, mat, texture	Thermolaqué INDOOR Noir, mat, uni
102500-000-00	102500-000-17	102500-000-19	102500-000-32	102500-000-82	102500-000-89
102500-04x-00		102500-04x-19			

Q-INFO MOD 5015 / 2500

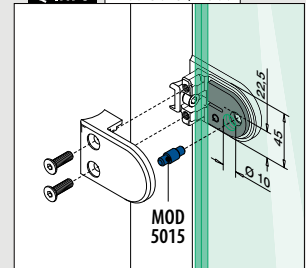

Pincès à verre - MOD 2800

Pour tube plat

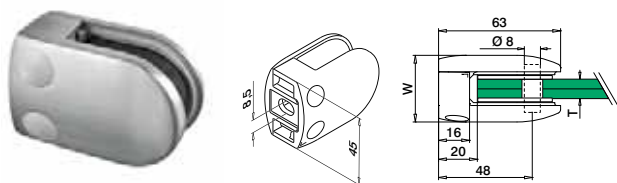

MOD 2800

304 Inox brossé

INDOOR	W	T		
132800-000-12	34	Voir MOD 5028	QS-26	474 4

304 Poli miroir

INDOOR	W	T		
132800-000-10	34	Voir MOD 5028	QS-26	474 4

SELL OUT

316 Inox brossé

OUTDOOR	W	T		
142800-000-12	34	Voir MOD 5028	QS-27	474 4

316 Poli miroir

OUTDOOR	W	T		
142800-000-10	34	Voir MOD 5028	QS-27	474 4

316 Black Line

OUTDOOR	W	T		
142800-000-82	34	Voir MOD 5028	QS-27	474 4

NEW

Zamak

INDOOR	W	T		
102800-000-...	36	Voir MOD 5028	QS-28	474 4

SELL OUT



International Design Modèle Protection

Cales caoutchouc pour MOD 2800



2 pièces par pince à verre

MOD 5028

Accessoires

Pour verre monolithique	T	
205028-06	6	8
205028-08	8	8
205028-10	10	8
205028-12	12	8
Pour verre feuilleté		
205028-09	8,76	8
205028-44	9,52	8
205028-11	10,76	8
205028-54	11,52	8
205028-13	12,76	8

Pour tube rond

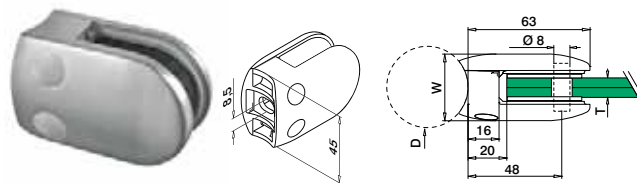

MOD 2800

304 Inox brossé

INDOOR	D	W	T		
132800-042-12	42,4	34	Voir MOD 5028	QS-47	474 4
132800-048-12	48,3	34	Voir MOD 5028	QS-47	474 4

304 Poli miroir

INDOOR	D	W	T		
132800-042-10	42,4	34	Voir MOD 5028	QS-47	474 4
132800-048-10	48,3	34	Voir MOD 5028	QS-47	474 4

SELL OUT

SELL OUT

316 Inox brossé

OUTDOOR	D	W	T		
142800-042-12	42,4	34	Voir MOD 5028	QS-45	474 4
142800-048-12	48,3	34	Voir MOD 5028	QS-45	474 4

316 Poli miroir

OUTDOOR	D	W	T		
142800-042-10	42,4	34	Voir MOD 5028	QS-45	474 4
142800-048-10	42,4	34	Voir MOD 5028	QS-45	474 4

NEW

Zamak

INDOOR	D	W	T		
102800-042-...	42,4	36	Voir MOD 5028	QS-46	474 4
102800-048-...	48,3	36	Voir MOD 5028	QS-46	474 4

SELL OUT

SELL OUT



International Design Modèle Protection

Accessoires

Goupilles de sécurité

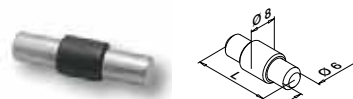

Optionnel pour MOD 2800

MOD 5015

Accessoires

	L	
205015-22	22	4

Q-INFO 304 316 MOD 2800 Finitions

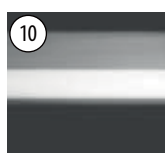

Poli miroir

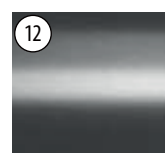

Inox brossé



Noir, mat, texture

Q-INFO Zamak MOD 2800 Finitions

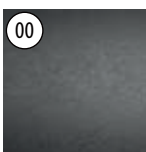

Brut

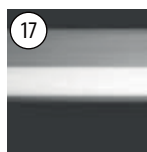

Chromé brillant



Aspect inox brossé



Noir, mat, texture



Noir, mat, uni

102800-000-00

102800-000-17

102800-000-19

102800-000-82

102800-000-89

102800-04x-00

102800-04x-19

102800-04x-82

102800-04x-89

Q-INFO MOD 5015 / 2800

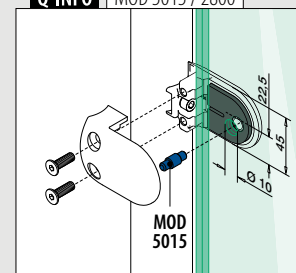

Pincès à verre - MOD 4200

Pour tube plat

Entretoise de sécurité comprise

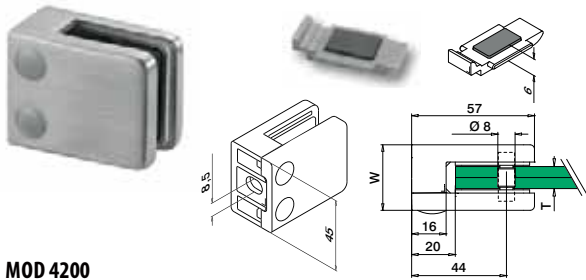

MOD 4200

304		Inox brossé							
INDOOR	W	T							
134200-000-12	28	Voir MOD 5042	QS-26	474	4				
316		Inox brossé							
OUTDOOR		144200-000-12	28	Voir MOD 5042	QS-27	474	4		
316		Poli miroir							
OUTDOOR		144200-000-10	28	Voir MOD 5042	QS-27	474	4		
316		Black Line							
OUTDOOR		144200-000-82	28	Voir MOD 5042	QS-27	474	4		
Zamak		INDOOR		104200-000-...	30	Voir MOD 5042	QS-28	474	4

International Design
Modèle Protection

Pour tube rond

Entretoise de sécurité comprise

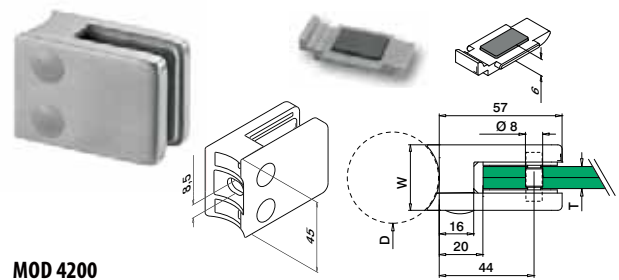

MOD 4200

304		Inox brossé								
INDOOR	D	W	T							
134200-042-12	42,4	28	Voir MOD 5042	QS-47	474	4				
134200-048-12	48,3	28	Voir MOD 5042	QS-47	474	4				
304		Black Line								
INDOOR		134200-042-82	42,4	28	Voir MOD 5042	QS-47	474	4		
316		Inox brossé								
OUTDOOR		144200-042-12	42,4	28	Voir MOD 5042	QS-45	474	4		
144200-048-12	48,3	28	Voir MOD 5042	QS-45	474	4				
316		Poli miroir								
OUTDOOR		144200-042-10	42,4	28	Voir MOD 5042	QS-45	474	4		
144200-048-10	48,3	28	Voir MOD 5042	QS-45	474	4				
Zamak		INDOOR		104200-042-...	42,4	30	Voir MOD 5042	QS-46	474	4
104200-048-...	48,3	30	Voir MOD 5042	QS-46	474	4				

International Design
Modèle Protection

Q-INFO | 304 | 316 | MOD 4200 | Finitions

10

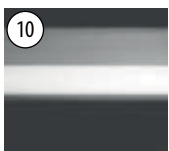

Poli miroir

12



Inox brossé

82 RAL 9005

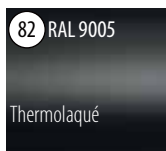
Noir, mat,
texture

Q-INFO

00

Une finition .00 est prête
à être thermolaquée.

Q-INFO



418

Utilisation de la pince MOD 4200
comme pince à tôle également

Q-INFO | Zamak | MOD 4200 | Finitions

00



Brut

17

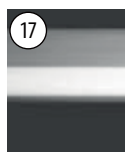

Chromé brillant

19

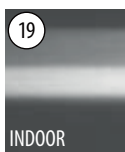
Aspect inox
brossé

32 RAL 9016

Blanc, brillant de
soie, uni

33

Gris anthracite,
mat, texture

36

Aluminium
blanc, brillant de
soie, uni

82

Noir, mat,
texture

89



Noir, mat, uni



104200-000-00

104200-000-17

104200-000-19

104200-000-32

104200-000-33

104200-000-36

104200-000-82

104200-000-89



104200-04x-00

104200-04x-19

104200-042-82

104200-042-89

Pincès à verre - MOD 4200

Pour tube plat

Entretoise de sécurité comprise

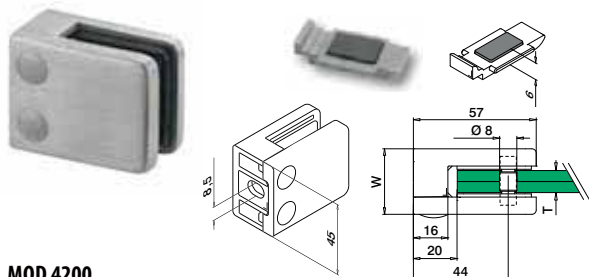

MOD 4200

Aluminium

INDOOR	W	T		
164200-000-...	30	Voir MOD 5042	QS-26	474 4



Pour tube rond

Entretoise de sécurité comprise

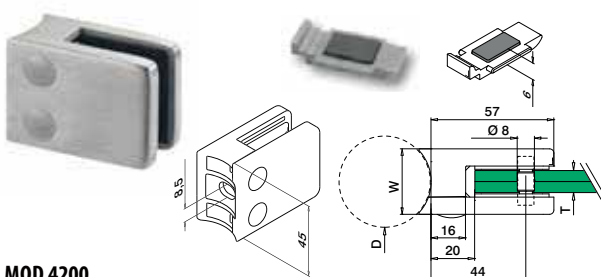

MOD 4200

Aluminium

INDOOR	D	W	T		
164200-042-...	42,4	30	Voir MOD 5042	QS-47	474 4
164200-048-...	48,3	30	Voir MOD 5042	QS-47	474 4



Cales caoutchouc pour MOD 4200



2 pièces par pince à verre

MOD 5042

Accessoires

Pour verre monolithique	T	
205042-06	6	8
205042-08	8	8
205042-10	10	8
205042-12	12	8

Pour verre feuilleté

205042-07	6,76	8
205042-41	8,38	8
205042-09	8,76	8
205042-44	9,52	8
205042-11	10,76	8
205042-54	11,52	8
205042-13	12,76	8

Goupilles de sécurité

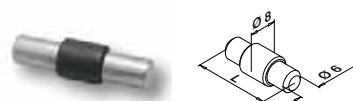

Optionnel pour MOD 4200

MOD 5015

Accessoires

	L	
205015-22	22	4

Q-INFO Aluminium MOD 4200 Finitions

00

Brut



164200-000-00



164200-04x-00

32 RAL 9016

Thermolaqué INDOOR

Blanc, brillant de soie, uni

164200-000-32

33 RAL 7016

Gris anthracite, mat, uni

164200-000-33

36 RAL 9006

Aluminium blanc, brillant de soie, uni

164200-000-36

82 RAL 9005

Thermolaqué

Noir, mat, texture

164200-000-82

164200-04x-82

89 RAL 9005

Thermolaqué INDOOR

Noir, mat, uni

164200-000-89

Q-INFO

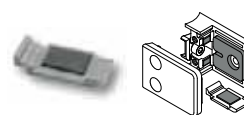

Insérez l'entretoise de sécurité dans la pince à verre au lieu d'utiliser une goupille de sécurité. Vos frais sont réduits car il est inutile de percer le verre.

Q-INFO MOD 5015 / 4200

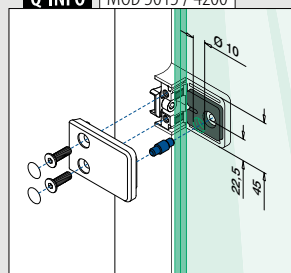

Pincès à verre - MOD 2100

Pour tube plat

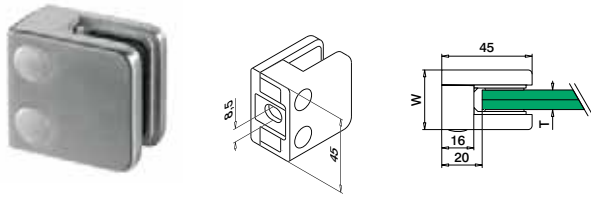

MOD 2100

304 Inox brossé

INDOOR	W	T		
132100-000-12	27	Voir MOD 5021	QS-26 474	4

304 Black Line

INDOOR	W	T		
132100-000-82	27	Voir MOD 5021	QS-26 474	4

316 Inox brossé

OUTDOOR	W	T		
142100-000-12	27	Voir MOD 5021	QS-27 474	4



MOD 2100 testé uniquement pour l'intérieur

MOD 2100

Zamak

INDOOR	W	T		
102100-000-...	29	Voir MOD 5021	QS-28 474	4



Pour tube rond

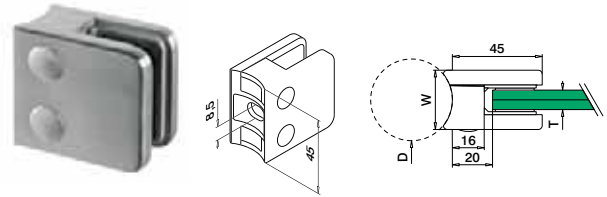

MOD 2100

304 Inox brossé

INDOOR	D	W	T		
132100-042-12	42,4	27	Voir MOD 5021	QS-47 474	4

316 Inox brossé

OUTDOOR	D	W	T		
142100-042-12	42,4	27	Voir MOD 5021	QS-45 474	4



MOD 2100 testé uniquement pour l'intérieur

MOD 2100

Zamak

INDOOR	D	W	T		
102100-042-...	42,4	29	Voir MOD 5021	QS-46 474	4



Cales caoutchouc pour MOD 2100



2 pièces par pince à verre

MOD 5021

Accessoires

Pour verre monolithique	T	
205021-06	6	8
205021-08	8	8
205021-10	10	8

Pour verre feuilleté

205021-07	6,76	8
205021-09	8,76	8
205021-44	9,52	8

Q-INFO 304 316 Finitions

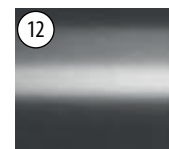

Inox brossé



Noir, mat, texture

Q-INFO Zamak MOD 2100 Finitions



Brut



Chromé brillant



Aspect inox brossé

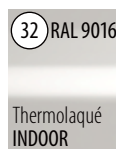

Blanc, brillant de soie, uni



Noir, mat, texture



Noir, mat, uni



102100-000-00

102100-000-17

102100-000-19

102100-000-32

102100-000-82

102100-000-89



102100-042-00

102100-042-19

Q-INFO



Une finition .00 est prête à être thermolaquée.

Pincès à verre - MOD 2600

Pour tube plat

Entretoise de sécurité comprise

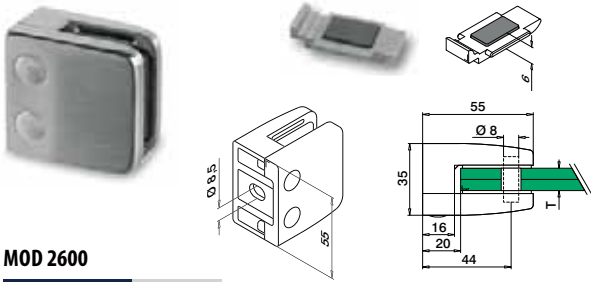

MOD 2600

304 Inox brossé

INDOOR

T



SELL OUT	132600-000-12	Voir MOD 5026	QS-26	474	4
----------	---------------	---------------	-------	-----	---

316

Inox brossé

OUTDOOR

SELL OUT	142600-000-12	Voir MOD 5026	QS-27	474	4
----------	---------------	---------------	-------	-----	---



Pour tube rond

Entretoise de sécurité comprise

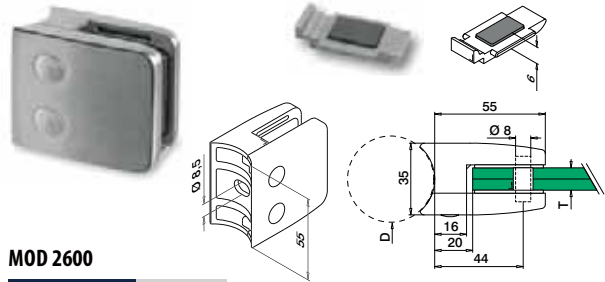

MOD 2600

304 Inox brossé

INDOOR

D

T



SELL OUT	132600-042-12*	42,4	Voir MOD 5026	QS-47	474	4
----------	----------------	------	---------------	-------	-----	---

SELL OUT	132600-048-12	48,3	Voir MOD 5026	QS-47	474	4
----------	---------------	------	---------------	-------	-----	---

316

Inox brossé

OUTDOOR

SELL OUT	142600-042-12*	42,4	Voir MOD 5026	QS-45	474	4
----------	----------------	------	---------------	-------	-----	---

SELL OUT	142600-048-12	48,3	Voir MOD 5026	QS-45	474	4
----------	---------------	------	---------------	-------	-----	---

SELL OUT	142600-060-12	60,3	Voir MOD 5026	QS-45	474	4
----------	---------------	------	---------------	-------	-----	---



Cales caoutchouc pour MOD 2600



2 pièces par pince à verre.

MOD 5026

Accessoires

Pour verre monolithique

T



SELL OUT	205026-08	8	8
----------	-----------	---	---

SELL OUT	205026-10	10	8
----------	-----------	----	---

SELL OUT	205026-12	12	8
----------	-----------	----	---

Pour verre feuilleté

SELL OUT	205026-09	8,76	8
----------	-----------	------	---

SELL OUT	205026-11	10,76	8
----------	-----------	-------	---

SELL OUT	205026-54	11,52	8
----------	-----------	-------	---

SELL OUT	205026-13	12,76	8
----------	-----------	-------	---

SELL OUT Seulement jusqu'à épuisement des stocks.

Commander séparément le matériel de fixation.

Accessoires

Goupilles de sécurité

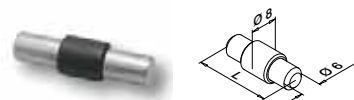

Optionnel pour MOD 2600

MOD 5015

Accessoires

		L	4
205015-25	25		

Q-INFO MOD 5015 / 2600

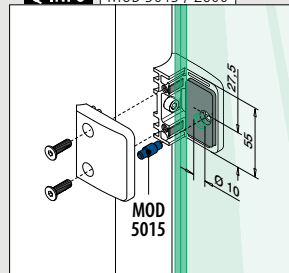

Q-INFO



Q-INFO MOD 2600

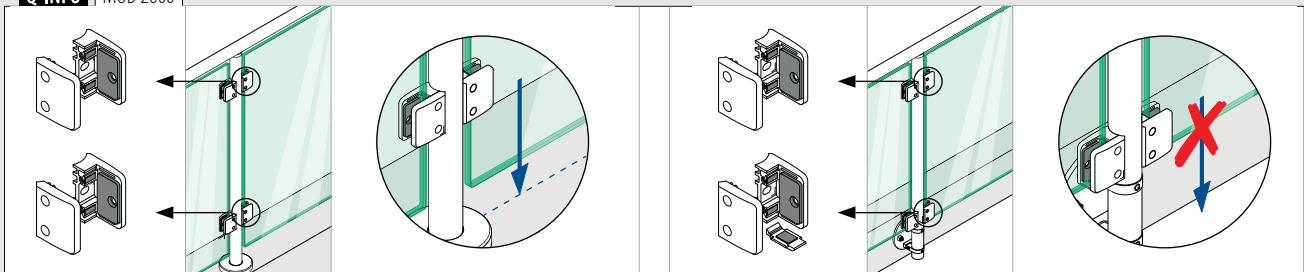

Pincès à verre - MOD 2400

Pour tube plat

Entretoise de sécurité comprise

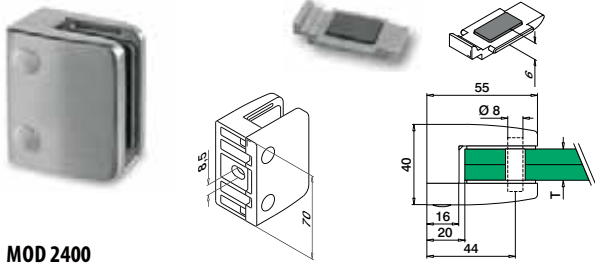

MOD 2400

304 Inox brossé

INDOOR T

SELL OUT	132400-000-12	Voir T en MOD 5024	QS-26	474	4
----------	---------------	--------------------	-------	-----	---

304 Poli miroir

INDOOR

SELL OUT	132400-000-10	Voir T en MOD 5024	QS-26	474	4
----------	---------------	--------------------	-------	-----	---

316 Inox brossé

OUTDOOR

SELL OUT	142400-000-12	Voir T en MOD 5024	QS-27	474	4
----------	---------------	--------------------	-------	-----	---

316 Poli miroir

OUTDOOR

SELL OUT	142400-000-10	Voir T en MOD 5024	QS-27	474	4
----------	---------------	--------------------	-------	-----	---

Zamak

INDOOR

SELL OUT	102400-000-...	Voir T en MOD 5024	QS-28	474	4
----------	----------------	--------------------	-------	-----	---



Remplissage

Cales caoutchouc pour MOD 2400



2 pièces par pince à verre

MOD 5024

Accessoires

Pour verre monolithique T

SELL OUT	205024-12	12	8
SELL OUT	205024-15	15	8

Pour verre feuilleté

SELL OUT	205024-44	9,52	8
SELL OUT	205024-54	11,52	8
SELL OUT	205024-13	12,76	8
SELL OUT	205024-64	13,52	8
SELL OUT	205024-17	16,76	8
SELL OUT	205024-18	17,52	8

Q-INFO Zamak Finitions

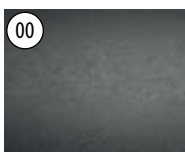

Brut



102400-000-00



Aspect inox brossé



102400-000-19

102400-000-19

Pour tube rond

Entretoise de sécurité comprise

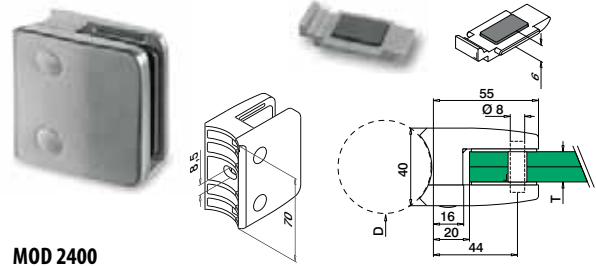

MOD 2400

304 Inox brossé

INDOOR D T

SELL OUT	132400-048-12	48,3	Voir T en MOD 5024	QS-47	474	4
----------	---------------	------	--------------------	-------	-----	---

316 Inox brossé

OUTDOOR

SELL OUT	142400-048-12	48,3	Voir T en MOD 5024	QS-45	474	4
----------	---------------	------	--------------------	-------	-----	---

Zamak

INDOOR

SELL OUT	102400-048-...	48,3	Voir T en MOD 5024	QS-46	474	4
----------	----------------	------	--------------------	-------	-----	---



Accessoires

Goupilles de sécurité

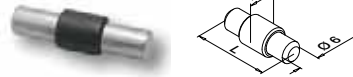

Optionnel pour MOD 2400

MOD 5015

Accessoires

205015-24	L	30	4
-----------	---	----	---

SELL OUT Seulement jusqu'à épuisement des stocks.

Q-INFO MOD 5015 / 2400

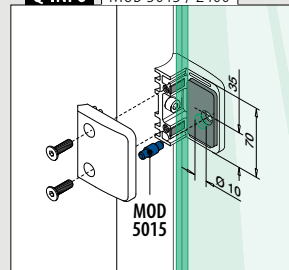

Q-INFO



Q-INFO 304 316

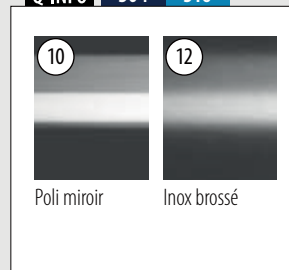

10

Poli miroir

12

Inox brossé

Q-INFO



00

Une finition .00 est prête à être thermolaquée.

Pincès à verre - MOD 2300

Pour tube plat + montage mural

Entretoise de sécurité comprise

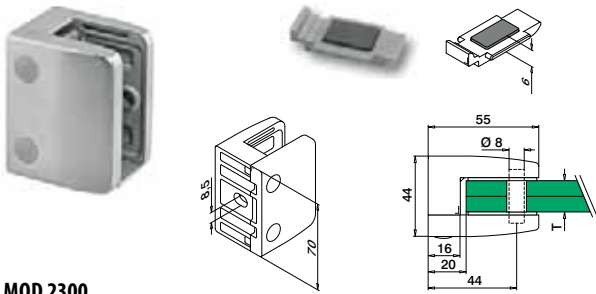

MOD 2300

304 Inox brossé

INDOOR

T



132300-000-12 Voir T en MOD 5023 QS-26 474 4

316 Inox brossé

OUTDOOR

142300-000-12 Voir T en MOD 5023 QS-27 474 4



Pour tube rond

Entretoise de sécurité comprise

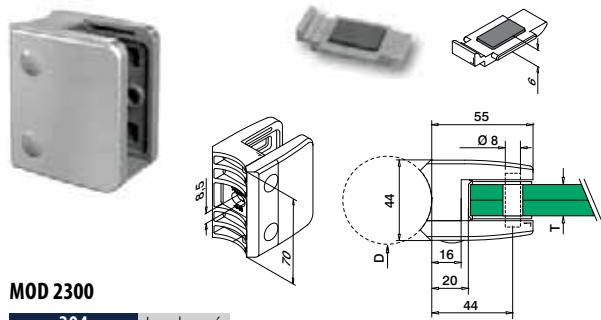

MOD 2300

304 Inox brossé

INDOOR

D

T



132300-048-12 48,3 Voir T en MOD 5023 QS-47 474 4

316 Inox brossé

OUTDOOR

142300-048-12 48,3 Voir T en MOD 5023 QS-45 474 4

NEW

Cales caoutchouc pour MOD 2300



2 pièces par pince à verre

MOD 5023

Accessoires

Pour verre monolithique		T	
NEW	205023-12	12	8
NEW	205023-15	15	8
	205023-19	19	8

Pour verre feuilleté

NEW	205023-44	9,52	8
NEW	205023-54	11,52	8
NEW	205023-13	12,76	8
NEW	205023-64	13,52	8
NEW	205023-17	16,76	8
NEW	205023-18	17,52	8
	205023-21	20,76	8
	205023-22	21,52	8

Commander séparément le matériel de fixation.

Q-INFO

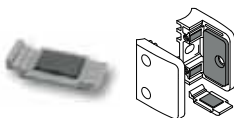

Insérez l'entretoise de sécurité dans la pince à verre au lieu d'utiliser une goupille de sécurité. Vos frais sont réduits car il est inutile de percer le verre.

Q-INFO MOD 5015 / 2300

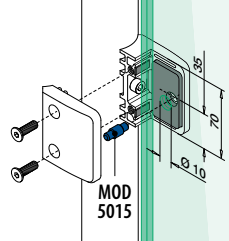

Goupilles de sécurité

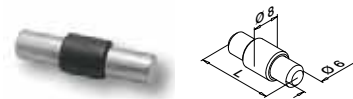

Optionnel pour MOD 2300

MOD 5015

Accessoires

		L	
	205015-23	34	4

MOD 4901
304

Q-INFO MOD 2300

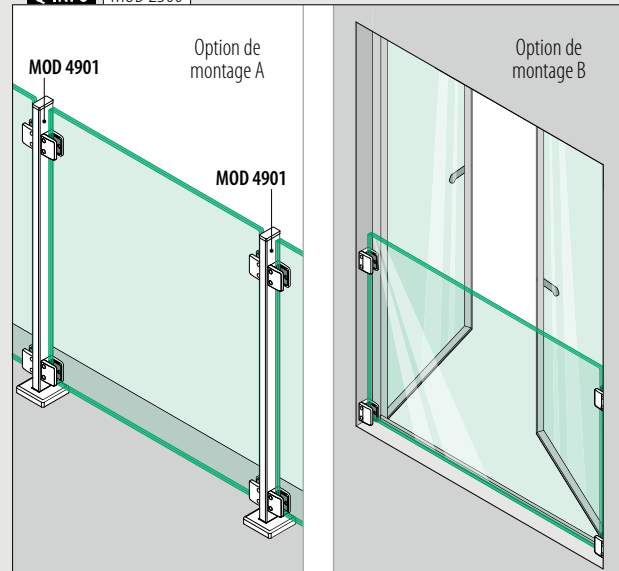

Pincès à verre - MOD 4400 / 4600

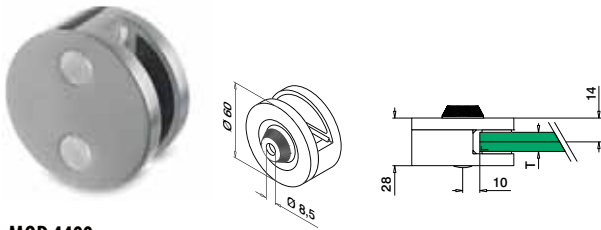

MOD 4400

304		Inox brossé		
INDOOR	T			
134400-12	Voir T en MOD 5044	QS-47	474	4
316		Inox brossé		
OUTDOOR				
144400-12	Voir T en MOD 5044	QS-45	474	4
Zamak		Aspect inox brossé		
OUTDOOR				
104400-20	Voir T en MOD 5044	QS-46	474	4

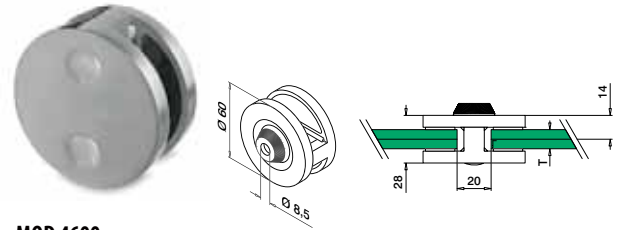

MOD 4600

304		Inox brossé		
INDOOR	T			
134600-12	Voir T en MOD 5044	QS-47	474	4
316		Inox brossé		
OUTDOOR				
144600-12	Voir T en MOD 5044	QS-45	474	4
Zamak		Aspect inox brossé		
OUTDOOR				
104600-20	Voir T en MOD 5044	QS-46	474	4



Adaptateur pour MOD 4400 / 4600

Pour tube plat



MOD 0723

304		Inox brossé	
INDOOR	D		
130723-000-12			4
316		Inox brossé	
OUTDOOR			
140723-000-12			4
Zamak		Aspect inox brossé	
OUTDOOR			
100723-000			4

Pour tube rond

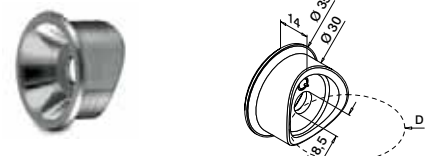

MOD 0723

304		Inox brossé	
INDOOR	D		
130723-042-12	42,4		4
130723-048-12	48,3		4
316		Inox brossé	
OUTDOOR			
140723-042-12	42,4		4
140723-048-12	48,3		4
Zamak		Aspect inox brossé	
OUTDOOR			
100723-042	42,4		4

Cales caoutchouc pour MOD 4400 / 4600

2 pièces pour MOD 4400,
4 pièces pour MOD 4600

MOD 5044

Accessoires		
Pour verre monolithique	T	
205044-08	8	8
205044-10	10	8
205044-12	12	8
Pour verre feuilleté		
205044-09	8,76	8
205044-11	10,76	8
205044-13	12,76	8

SELL OUT Seulement jusqu'à épuisement des stocks.

Q-INFO

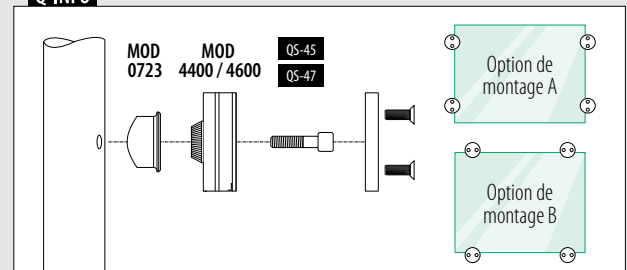

Pincés à verre - MOD 5100 / 5200

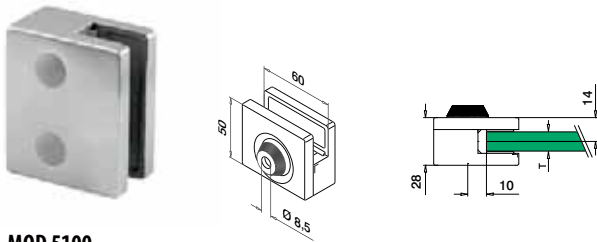

MOD 5100

304		Inox brossé	
INDOOR	T		
135100-12	Voir T en MOD 5051	QS-47 474	4
316		Inox brossé	
OUTDOOR			
145100-12	Voir T en MOD 5051	QS-45 474	4

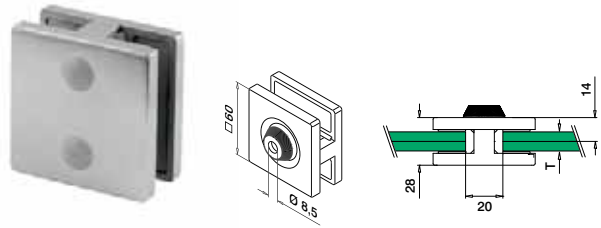

MOD 5200

304		Inox brossé	
INDOOR	T		
135200-12	Voir T en MOD 5051	QS-47 474	4
316		Inox brossé	
OUTDOOR			
145200-12	Voir T en MOD 5051	QS-45 474	4



Adaptateur pour MOD 5100 / 5200

Pour tube plat

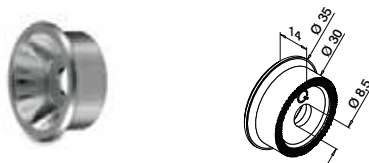

MOD 0723

304		Inox brossé	
INDOOR			
130723-000-12			4
316		Inox brossé	
OUTDOOR			
140723-000-12			4

Pour tube rond

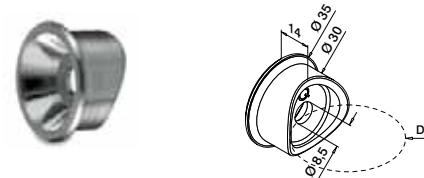

MOD 0723

304		Inox brossé	
INDOOR	D		
130723-042-12	42,4		4
130723-048-12	48,3		4
316		Inox brossé	
OUTDOOR			
140723-042-12	42,4		4
140723-048-12	48,3		4

Cales caoutchouc pour MOD 5100 / 5200

2 pièces pour MOD 5100,
4 pièces pour MOD 5200

MOD 5051

Accessoires		
Pour verre monolithique	T	
205051-08	8	8
205051-10	10	8
Pour verre feuilleté		
205051-09	8,76	8
205051-11	10,76	8
205051-13	12,76	8

Q-INFO

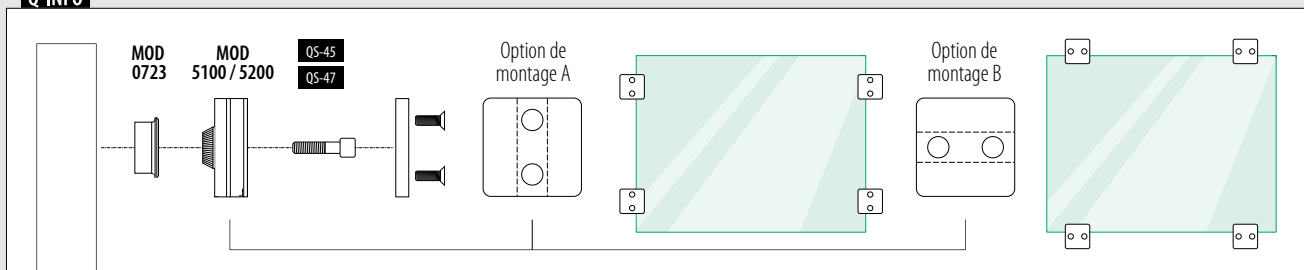

Remplissage

Pinces à verre - MOD 2900

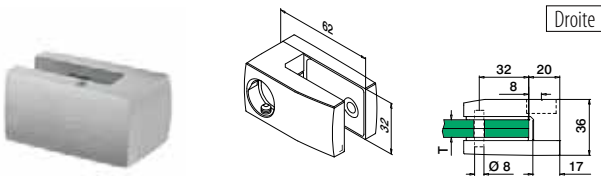

Droite

MOD 2900

316 Inox brossé

OUTDOOR

T



SELL OUT	142900-01-12	Voir T en MOD 5029	2
----------	--------------	--------------------	---



International Design Modèle Protection

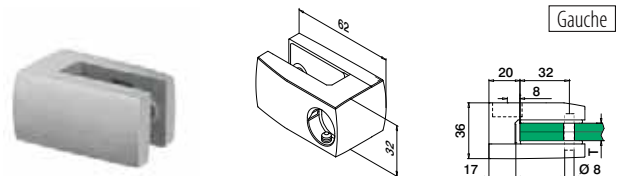

Gauche

MOD 2900

316 Inox brossé

OUTDOOR

T



SELL OUT	142900-02-12	Voir T en MOD 5029	2
----------	--------------	--------------------	---



International Design Modèle Protection

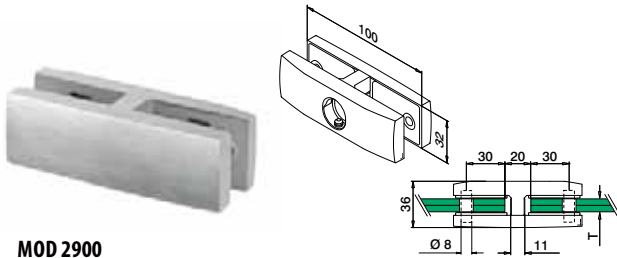

MOD 2900

316 Inox brossé

OUTDOOR

T



SELL OUT	142900-00-12	Voir T en MOD 5029	2
----------	--------------	--------------------	---



International Design Modèle Protection

Accessoires

Goupilles de sécurité

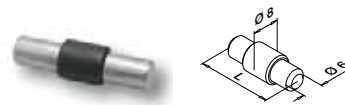

Optionnel pour MOD 2900

MOD 5015

Accessoires

L



205015-22	22	4
-----------	----	---

Remplissage

Adaptateur pour MOD 2900

Pour tube plat



MOD 0785

316 Inox brossé

OUTDOOR



140785-000-12	QS-16 472	4
---------------	-----------	---



Pour tube rond

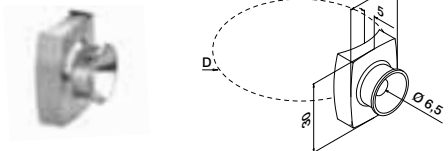

MOD 0785

316 Inox brossé

OUTDOOR

D



140785-042-12	42,4	QS-16 472	4
---------------	------	-----------	---

140785-048-12	48,3	QS-16 472	4
---------------	------	-----------	---



Remplissage

Cales caoutchouc pour MOD 2900



2 pièces par pince à verre,
4 pièces par MOD 142900-00-12

MOD 5029

Accessoires

Pour verre monolithique		T	
-------------------------	--	---	--

SELL OUT	205029-08	8	4
SELL OUT	205029-10	10	4
SELL OUT	205029-12	12	4

Pour verre feuilleté

SELL OUT	205029-09	8,76	4
SELL OUT	205029-11	10,76	4
SELL OUT	205029-13	12,76	4
SELL OUT	205029-64	13,52	4

Q-INFO MOD 0785

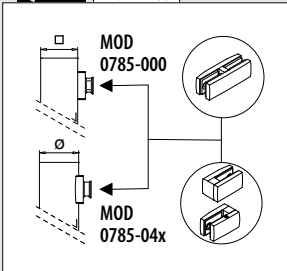

Commander séparément le matériel de fixation.

SELL OUT Seulement jusqu'à épuisement des stocks.

Q-INFO MOD 2900

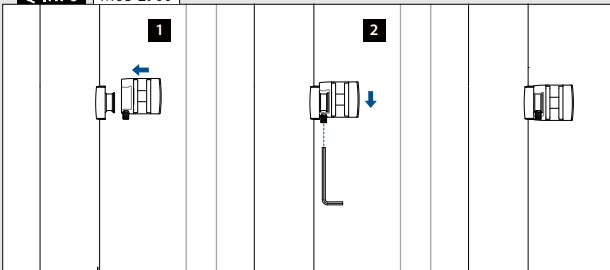



MOD 5500

Q-railing

Supports de verre - MOD 5500

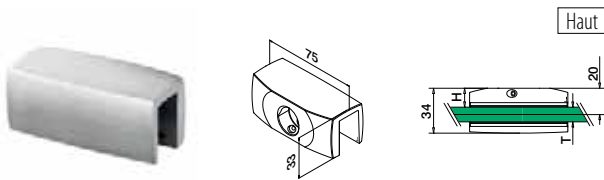

MOD 5500

316	Inox brossé			
OUTDOOR	T	H		
145500-01-12	Voir T en MOD 5055	Voir H en MOD 5055	2	



International Design Modèle Protection

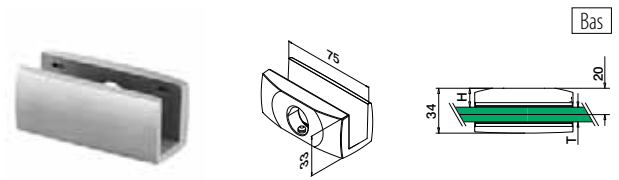

MOD 5500

316	Inox brossé			
OUTDOOR	T	H		
145500-02-12	Voir T en MOD 5055	Voir H en MOD 5055	2	



International Design Modèle Protection

Adaptateur pour MOD 5500

Pour tube plat

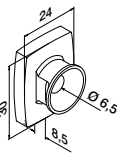

MOD 0785

316	Inox brossé			
OUTDOOR				
140785-000-12	QS-16 472	4		



Pour tube rond

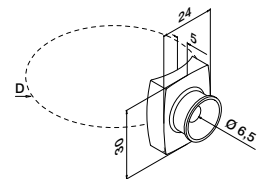

MOD 0785

316	Inox brossé			
OUTDOOR	D			
140785-042-12	42,4	QS-16 472	4	
140785-048-12	48,3	QS-16 472	4	



Cales caoutchouc



1 pièce par pince à verre

MOD 5055

Accessoires			
Pour verre monolithique	T	H	
205055-08	8	15,5	2
205055-10	10	14,5	2
205055-12	12	13,5	2

Pour verre feuilleté

205055-08	8,76	15	2
205055-10	10,76	14,5	2
205055-54	11,52	14	2
205055-12	12,76	13,5	2
205055-64	13,52	13	2

Q-INFO MOD 0785

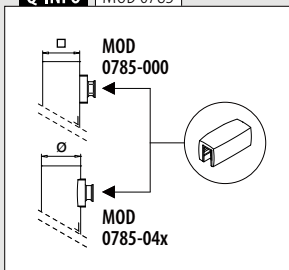

Q-INFO MOD 5500-02

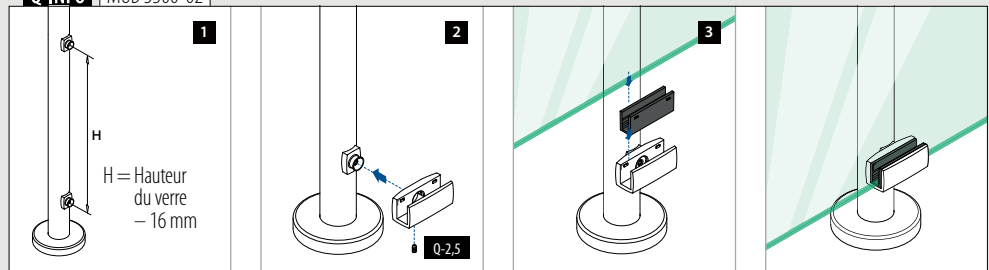

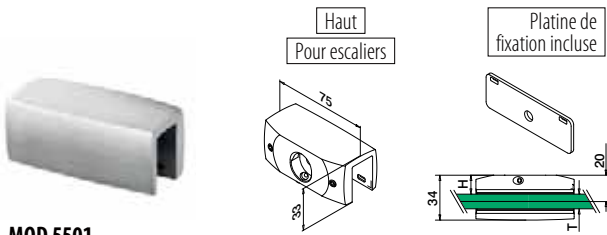
**MOD 5501****316** Inox brossé**OUTDOOR****T****H****2**

145501-01-12

Voir T en MOD 5055

Voir H en MOD 5055

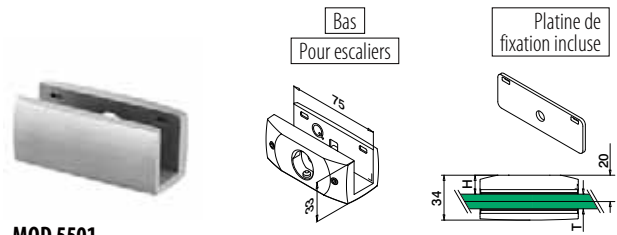

International Design Modèle Protection

**MOD 5501****316** Inox brossé**OUTDOOR****T****H****2**

145501-02-12

Voir T en MOD 5055

Voir H en MOD 5055



International Design Modèle Protection

Adaptateur pour MOD 5501

Pour tube plat

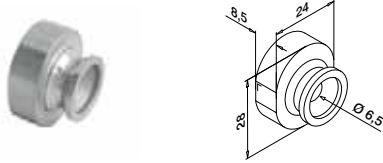
**MOD 0786****316** Inox brossé**OUTDOOR**

140786-000-12

QS-16 472

2

Pour tube rond

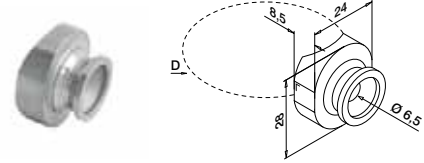
**MOD 0786****316** Inox brossé**OUTDOOR****D**

140786-042-12

42,4

QS-16 472

2

140786-048-12

48,3

QS-16 472

2

Goupilles de sécurité

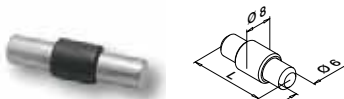
**MOD 5015**

Accessoires

L

205015-25

25

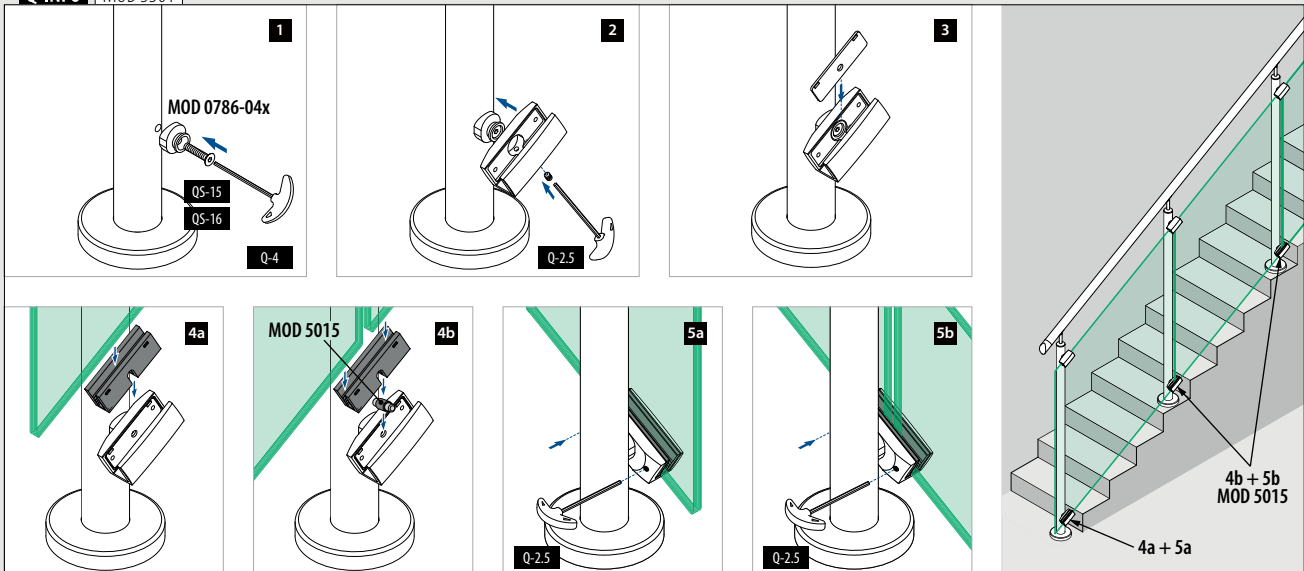
4**Q-INFO** MOD 5501

Pincas de liaison - MOD 2870 / 2880 / 2890

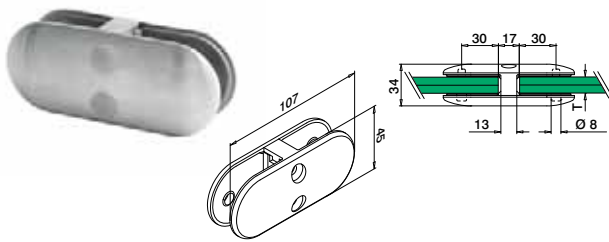

MOD 2870

304		Inox brossé		
INDOOR	T			
132870-13-12	Voir T en MOD 5028			2
316		Inox brossé		
OUTDOOR				
142870-13-12	Voir T en MOD 5028			2



International Design Modèle Protection

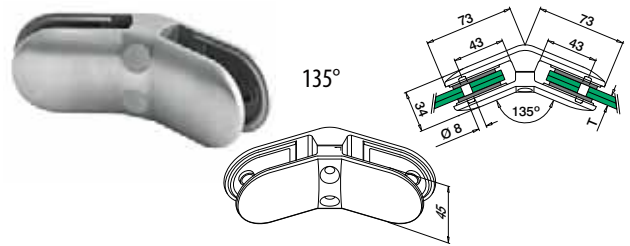

MOD 2880

316		Inox brossé		
OUTDOOR	T			
142880-13-12	Voir T en MOD 5028			2



International Design Modèle Protection

Remplissage

Cales caoutchouc pour MOD 2870 / 2880 / 2890

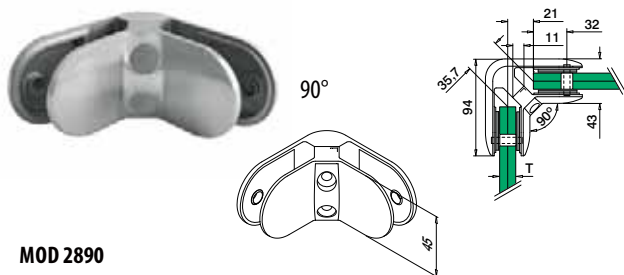

MOD 2890

304		Inox brossé		
INDOOR	T			
132890-13-12	Voir T en MOD 5028			2
316		Inox brossé		
OUTDOOR				
142890-13-12	Voir T en MOD 5028			2



International Design Modèle Protection



4 pièces par pince de liaison

MOD 5028

Accessoires

Pour verre monolithique		T	
205028-06	6		8
205028-08	8		8
205028-10	10		8
205028-12	12		8

Pour verre feuilleté

205028-09	8,76	8
205028-44	9,52	8
205028-11	10,76	8
205028-54	11,52	8
205028-13	12,76	8

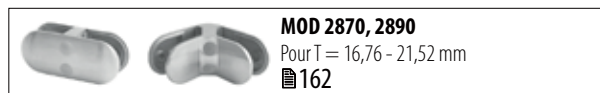

Q-INFO MOD 2870

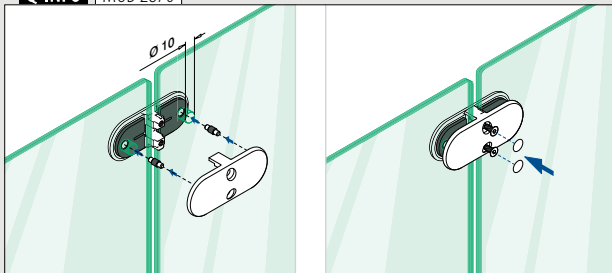

Q-INFO MOD 2880

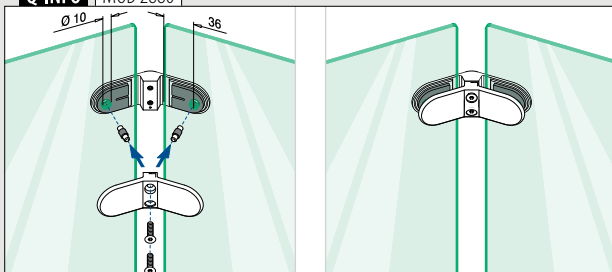

Accessoires

Goupilles de sécurité

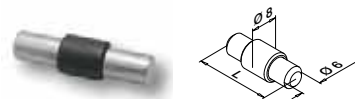

Optionnel pour MOD 2870 / 2880 / 2890

MOD 5015

Accessoires

		L	
205015-22	22		4

Q-INFO MOD 2890

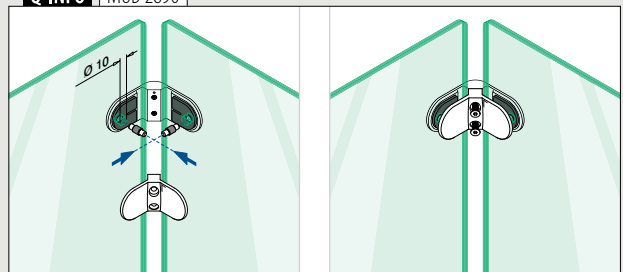

Pincés de liaison - MOD 4270 / 4280 / 4290

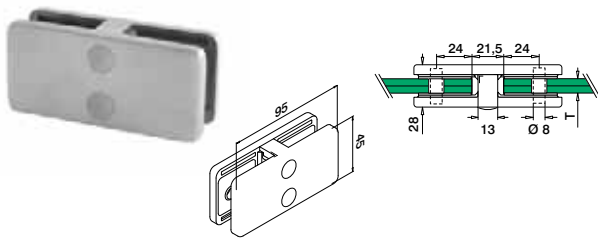

MOD 4270

304		Inox brossé	
INDOOR	T		
134270-13-12	Voir T en MOD 5042		2
316		Inox brossé	
OUTDOOR			
144270-13-12	Voir T en MOD 5042		2



International Design Modèle Protection

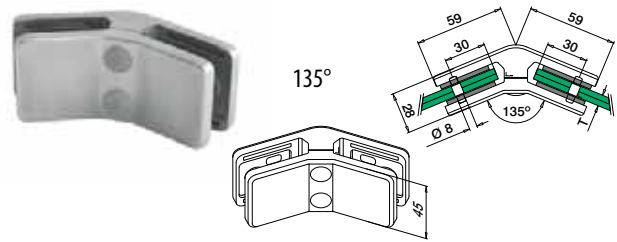

MOD 4280

316		Inox brossé	
OUTDOOR	T		
144280-13-12	Voir T en MOD 5042		2



International Design Modèle Protection

Cales caoutchouc pour MOD 4270 / 4280 / 4290

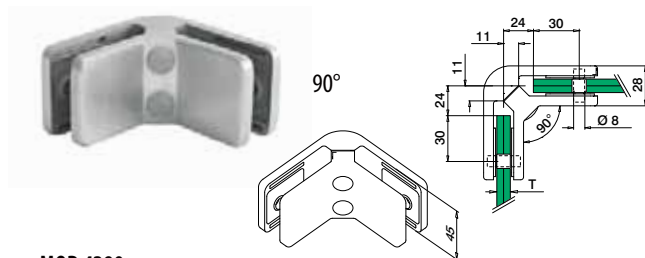

MOD 4290

304		Inox brossé	
INDOOR	T		
134290-13-12	Voir T en MOD 5042		2
316		Inox brossé	
OUTDOOR			
144290-13-12	Voir T en MOD 5042		2



MOD 5042

Accessoires		
Pour verre monolithique	T	
205042-06	6	8
205042-08	8	8
205042-10	10	8
205042-12	12	8
Pour verre feuilleté		
205042-07	6,76	8
205042-41	8,38	8
205042-09	8,76	8
205042-44	9,52	8
205042-11	10,76	8
205042-54	11,52	8
205042-13	12,76	8

Goupilles de sécurité

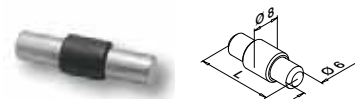
Optionnel pour
MOD 4270 / 4280 / 4290

MOD 5015

Accessoires		
	L	
205015-22	22	4

Q-INFO MOD 4270

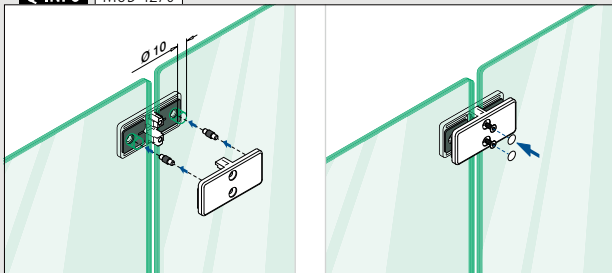

Q-INFO MOD 4280

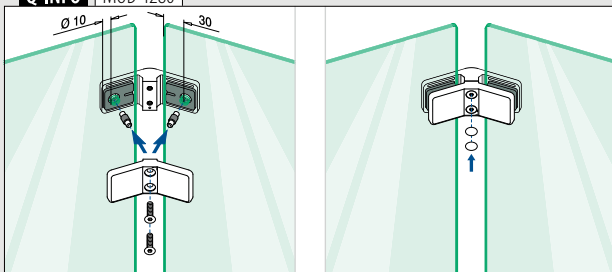

Q-INFO MOD 4290

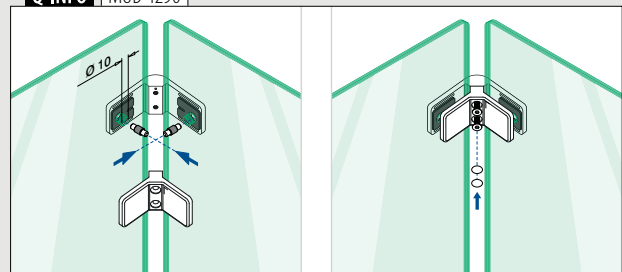

Verre - verre

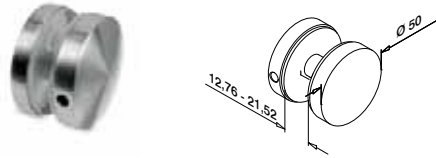
**MOD 0742**

304	Inox brossé	
INDOOR		
130742-12		2
316	Inox brossé	
OUTDOOR		
140742-12		2
316	Poli miroir	
OUTDOOR		
140742-10		2



Loquets

Pour tube plat

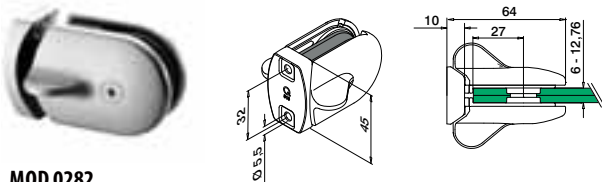
**MOD 0282**

316	Inox brossé		
OUTDOOR			
140282-000	QS-13	472	1



International Design Modèle Protection

Pour tube rond

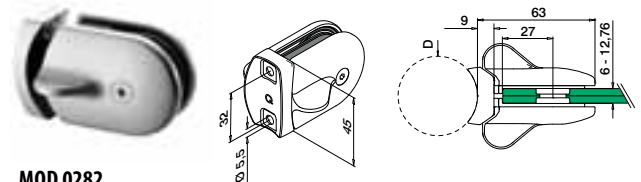
**MOD 0282**

316	Inox brossé		
OUTDOOR	D		
140282-042	42,4	QS-13	472
140282-048	48,3	QS-13	472



International Design Modèle Protection

Verre - verre

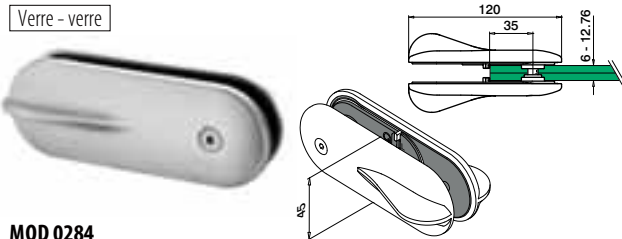
**MOD 0284**

316	Inox brossé	
OUTDOOR		
140284		1



International Design Modèle Protection

Commander séparément le matériel de fixation.

Q-INFO | 304 | 316

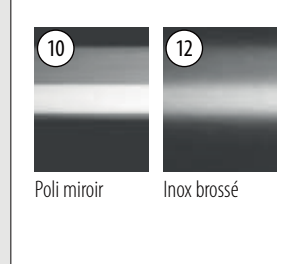

Q-INFO | MOD 0742

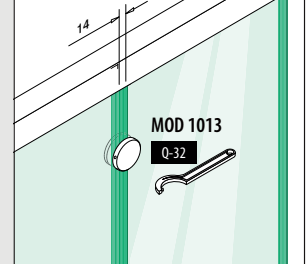

Q-INFO | MOD 0284

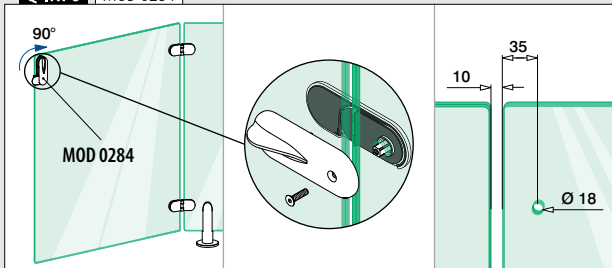

Q-INFO | MOD 0282

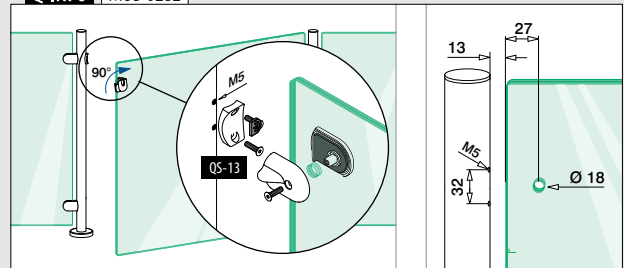

Charnières

Pour tube plat

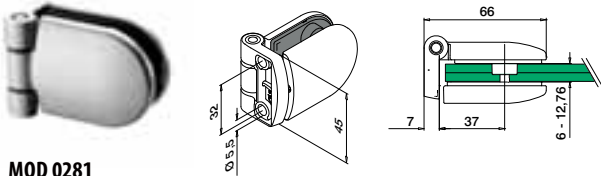

MOD 0281

316	Inox brossé		
OUTDOOR			
140281-000	QS-13	472	2



International Design Modèle Protection

Pour tube rond

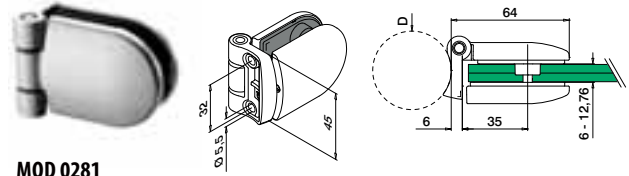

MOD 0281

316	Inox brossé		
OUTDOOR		D	
140281-042	42,4	QS-13	472
140281-048	48,3	QS-13	472



International Design Modèle Protection

Verre - verre

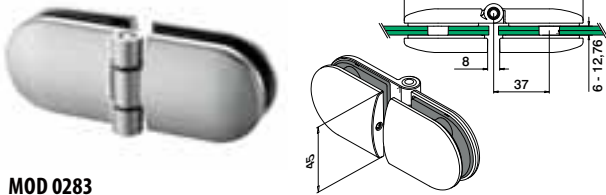

MOD 0283

316	Inox brossé		
OUTDOOR			
140283			2



International Design Modèle Protection

Q-INFO MOD 0283

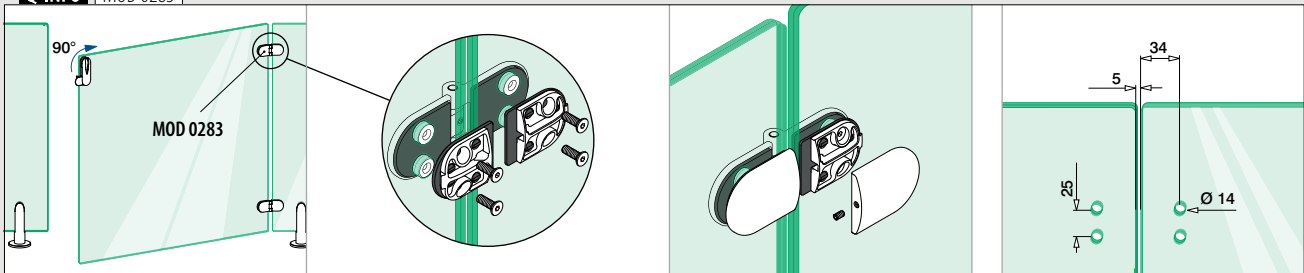

Q-INFO MOD 0281

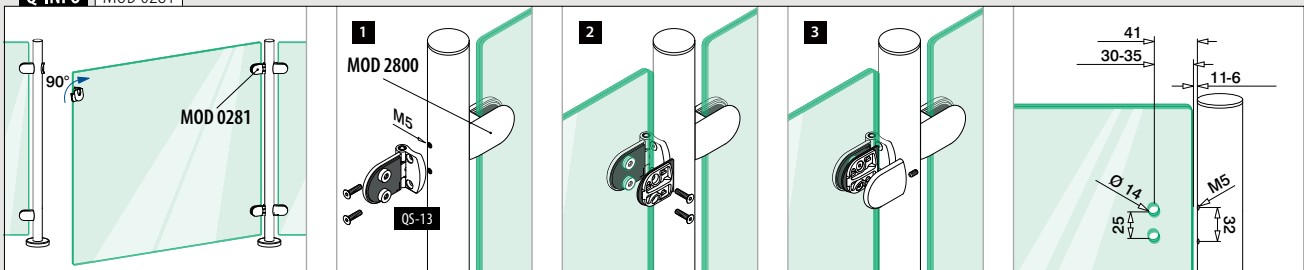



MOD 0754

Pour tube plat

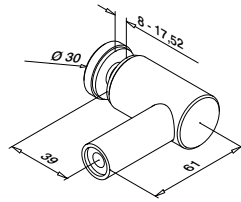

MOD 0754

316

Inox brossé

OUTDOOR

140754-000-12

QS-30 472



4



International Design Modèle Protection

Pour tube rond

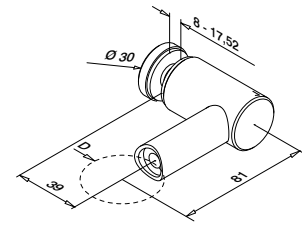

MOD 0754

316

Inox brossé

OUTDOOR

140754-042-12

D 42,4



472



4



International Design Modèle Protection

Commander séparément le matériel de fixation.

Q-INFO

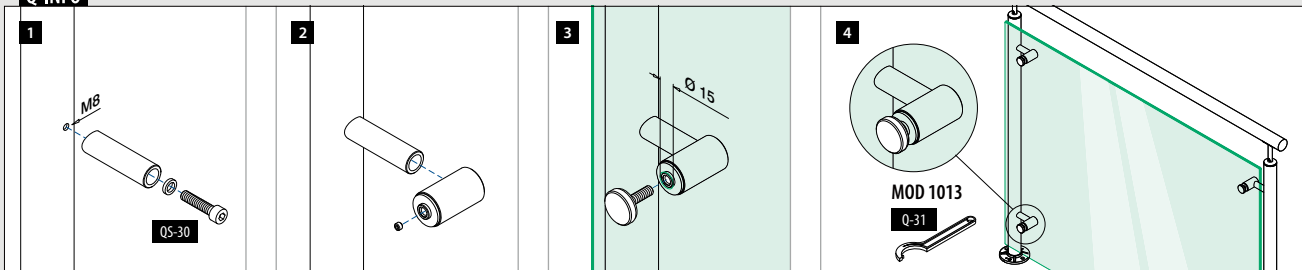

Pour tube plat

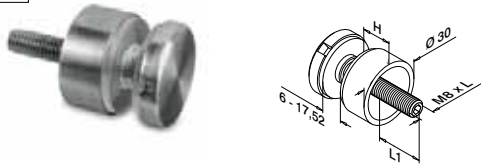

MOD 0746

304		Inox brossé		
INDOOR	H	L	L1	
130746-015-12	15	50	10 - 22	4
130746-020-12	20	60	14 - 26	4
130746-030-12	30	70	14 - 26	4
130746-040-12	40	80	14 - 26	4
130746-050-12	50	90	14 - 26	4

316		Inox brossé		
OUTDOOR				
140746-015-12	15	50	10 - 22	4

316		Poli miroir		
OUTDOOR				
140746-015-10	15	50	10 - 22	4

Zamak				
INDOOR				
100746-...	15	50	10 - 22	4



MOD 0740

304		Inox brossé		
INDOOR				
130740-12				4

316		Inox brossé		
OUTDOOR				
140740-12				4

316		Poli miroir		
OUTDOOR				
140740-10				4



Pour tube rond

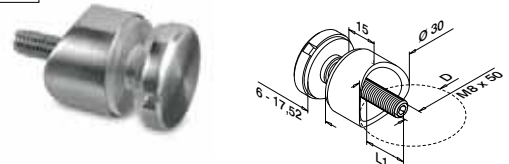

MOD 0746

304		Inox brossé		
INDOOR	D	L1		
130746-033-12	33,7	10 - 22		4
130746-042-12	42,4	10 - 22		4
130746-048-12	48,3	10 - 22		4

316		Inox brossé		
OUTDOOR				
140746-033-12	33,7	10 - 22		4
140746-042-12	42,4	10 - 22		4
140746-048-12	48,3	10 - 22		4
140746-060-12	60,3	10 - 22		4



Remplissage

Adaptateurs à verre

Ø 25 mm



MOD 0755

304		Inox brossé		
INDOOR	Ø			
130755-16	16			4

316		Inox brossé		
OUTDOOR				
140755-12	12			4



Q-INFO 316

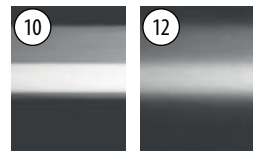

Poli miroir Inox brossé

Q-INFO MOD 0746

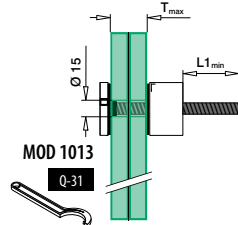

MOD 1013

Q-31

Q-INFO MOD 0755

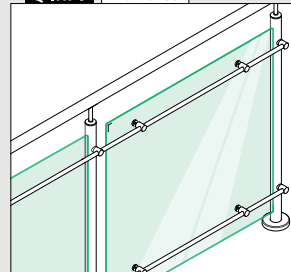

Q-INFO MOD 0755

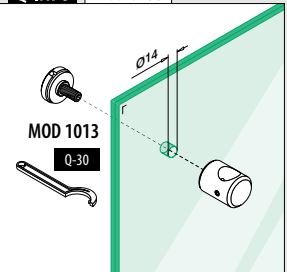

MOD 1013

Q-30

Q-INFO Zamak MOD 0746 Finitions

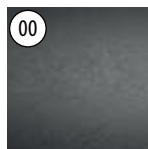

Brut

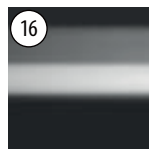

Chromé mat

Aspect inox
brossé

32 RAL 9016

Thermolaqué
INDOOR
Blanc, brillant de
soie, uni

89 RAL 9005

Thermolaqué
INDOOR
Noir, mat, uni

Q-INFO



MOD 5030 475

Autres cales caoutchouc pour
adaptateurs à verre

Pour tube plat

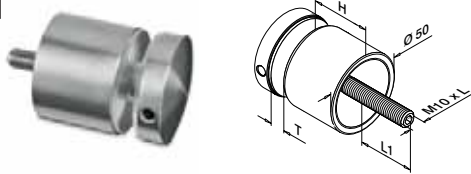
**MOD 0747****304** Inox brossé

INDOOR	H	T	L	L1	
130747-010-12	10	8 - 17,52	50	11 - 22	2
130747-020-12	20	8 - 25,52	70	13 - 31	2
130747-030-12	30	8 - 25,52	80	13 - 31	2
130747-040-12	40	8 - 17,52	80	11 - 22	2
130747-050-12	50	8 - 17,52	90	11 - 22	2

304 Black Line**INDOOR**

NEW	130747-010-82	10	8 - 17,52	50	11 - 22	2
NEW	130747-030-82	30	8 - 25,52	80	13 - 31	2

316 Inox brossé**OUTDOOR**

140747-010-12	10	8 - 17,52	50	11 - 22	2
140747-020-12	20	8 - 25,52	70	13 - 31	2
140747-030-12	30	8 - 25,52	80	13 - 31	2
140747-040-12	40	8 - 17,52	80	11 - 21	2
140747-050-12	50	8 - 17,52	90	11 - 21	2

316 Poli miroir**OUTDOOR**

140747-030-10	30	8 - 25,52	80	13 - 31	2
---------------	----	-----------	----	---------	---

Zamak Brut**INDOOR**

SELL OUT	100747-00	10	8 - 17,52	50	11 - 22	2
----------	-----------	----	-----------	----	---------	---

Zamak Aspect inox brossé**OUTDOOR**

SELL OUT	100747-20	10	8 - 17,52	50	11 - 22	2
----------	-----------	----	-----------	----	---------	---

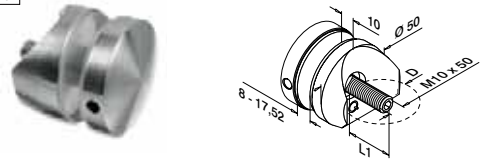

Pour tube rond

**MOD 1747****304** Inox brossé

INDOOR	D	L1	
SELL OUT 131747-010-42-12	42,4	10 - 20	2
131747-010-48-12	48,3	10 - 20	2

316 Inox brossé**OUTDOOR**

141747-010-42-12	42,4	10 - 20	2
------------------	------	---------	---

**Q-INFO** **Zamak**

00



Brut

20

Aspect inox
brossé**Q-INFO**

00

Une finition .00 est prête
à être thermolaquée.**Q-INFO** **304** **316**

10



Poli miroir

12



Inox brossé

82 RAL 9005

Noir, mat,
texture

SELL OUT Seulement jusqu'à épuisement des stocks.

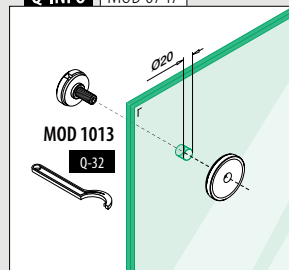
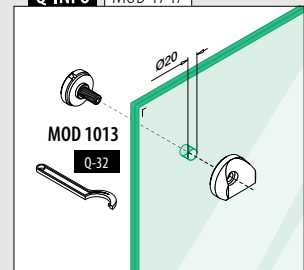
Q-INFO MOD 0747**Q-INFO** MOD 1747







6

ACCESSOIRES

Aperçu Q-vis / Q-ancres	456
Trouver la bonne fixation	457 - 463
Ancrages	464 - 467
Vis	468 - 472
Matériel de fixation	473 - 474
Pièce détachée pour pinces / adaptateurs à verre –	475
Perçage et taraudage	476 - 477
Accessoires d'aide à l'installation	478 - 481
Nettoyage et entretien	482
Outils	483 - 485
Index des symboles	487

Encore plus facile à commander ! Récapitulatif des pages 464 - 480.

QS	#		
QS-1	230205-050	50	471
QS-2	240205-050	50	471
QS-3	230200-760	50	471
QS-4	240200-760	50	471
QS-5	230210-025	50	471
QS-6	240210-025	50	471
QS-7	230210-038	50	471
QS-8	230230-025	50	471
QS-9	240230-025	50	471
QS-10	230690-516	50	472
QS-11	240690-516	50	472
QS-12	230670-520	50	472
QS-13	240670-520	50	472
QS-14	230670-620	50	472
QS-15	230670-625	50	472
QS-16	240670-625	50	472
QS-17	230670-630	50	472
QS-18	240670-630	50	472
QS-19	230670-825	50	472
QS-20	240670-825	50	472
QS-21	230670-840	50	472
QS-22	240670-840	50	472
QS-23	230680-620	50	472
QS-24	230680-635	50	472
QS-25	230680-660	50	472
QS-26	230680-820	50	472
QS-27	240680-820	50	472
QS-28	250680-820	50	472
QS-29	230680-835	50	472
QS-30	240680-835	50	472
QS-32	244010-212	10	464
QS-33	254010-212	10	464
QS-34	244110-875	10	467
QS-35	254110-875	10	467
QS-36	254210-212	25	467
QS-38	230800-616	50	474
QS-39	230800-817	50	474
QS-40	230800-121	50	474
QS-41	240670-616	50	475
QS-42	240670-620	50	475
QS-43	250670-616	50	475
QS-44	250670-620	50	475
QS-45	240681	50	474
QS-46	250681	50	474
QS-47	230681	50	474
QS-48	230670-612	50	472
QS-49	230211-340	50	471
QS-50	240210-038	50	471
QS-51	200842	50	480
QS-53	240680-620	50	472
QS-54	230680-645	50	472
QS-55	200851-827	50	470
QS-56	230230-038	50	471
QS-57	240230-038	50	471
QS-58	244110-190	10	467
QS-59	254110-190	10	467
QS-60	244010-217	10	464
QS-62	244010-880	10	464
QS-63	254010-880	10	464
QS-64	244010-185	10	464
QS-65	254010-185	10	464
QS-66	250803-120	50	478
QS-67	230680-140	50	472
QS-69	230803-818	50	478
QS-70	240680-645	50	472
QS-71	240680-660	50	472
QS-72	240680-140	50	472
QS-74	240670-240	50	472
QS-80	240800-616	50	474
QS-81	240800-817	50	474
QS-82	240800-121	50	474
QS-83	230690-616	50	472
QS-84	240690-616	50	472
QS-85	230205-090	50	471
QS-86	240205-090	50	471
QS-87	200841-635	100	470
QS-89	240670-612	50	472
QS-90	240400-505	50	472
QS-91	230400-505	50	472
QS-92	240400-610	50	472
QS-93	240490-506	50	472
QS-94	230490-506	50	472
QS-200	230240-412	50	471
QS-202	230690-510	50	472
QS-203	240690-510	50	472

QS	#		
QS-205	240670-608	50	472
QS-207	244510-290	10	465
QS-208	254510-290	10	465
QS-211	244510-212	10	465
QS-212	254510-212	10	465
QS-213	244260-180	50	468
QS-214	244250-180	50	468
QS-215	240663-224	50	473
QS-216	250663-224	50	473
QS-217	240664-220	50	473
QS-219	240661-235	50	473
QS-221	240662-230	50	473
QS-222	250662-230	50	473
QS-223	240661-230	50	473
QS-224	250661-230	50	473
QS-225	240661-245	50	473
QS-250	250260-008	50	469
QS-251	250260-012	50	469
QS-255	250250-808	50	469
QS-256	250250-812	50	469
QS-258	250250-012	50	469
QS-261	240690-608	50	472
QS-264	230250-608	50	469
QS-265	230250-610	50	469
QS-266	240915-550	50	469
QS-267	240212-438	50	471
QS-268	240212-413	50	471
QS-270	254410-811	10	464
QS-271	244410-811	10	464
QS-272	254410-113	10	464
QS-273	244410-113	10	464
QS-274	254410-215	10	464
QS-275	244410-215	10	464
QS-276	254410-217	10	464
QS-277	244410-217	10	464
QS-281	254410-820	10	464
QS-282	244410-820	10	464
QS-284	254410-226	10	464
QS-285	244410-226	10	464
QS-286	240665-232	50	468
QS-287	240666-816	50	473
QS-288	230491-850	50	470
QS-289	240651-208	50	473
QS-290	250251-010	25	469
QS-503	230210-060	50	471
QS-504	240210-060	50	471
QS-505	254510-210	10	465
QS-507	254010-217	10	464
QS-512	200203	50	478
QS-513	240650-865	50	473
QS-514	230650-865	50	473
QS-515	240650-108	50	473
QS-516	240650-210	50	473
QS-517	230650-108	50	473
QS-518	230650-210	50	473
QS-519	244210-212	25	467
QS-520	244510-180	10	465
QS-521	254510-180	10	465
QS-528	254510-875	10	465
QS-529	244510-875	10	465
QS-530	240670-135	50	472
QS-531	230670-135	50	472
QS-532	230670-130	50	472
QS-533	240670-130	50	472
QS-549	244010-213	10	464
QS-551	230680-240	50	472
QS-555	200841-160	50	470
QS-556	240200-890	50	471
QS-557	244519-290	10	465
QS-558	254519-290	10	465
QS-559	244519-210	10	465
QS-560	244220-285	25	467
QS-561	254220-285	25	467
QS-562	244220-211	25	467
QS-563	254220-211	25	467
QS-570	200843-008	25	470
QS-571	254300-110	50	468
QS-572	244300-110	50	468
QS-573	244300-112	50	468
QS-574	254310-110	50	468
QS-575	244310-110	50	468
QS-576	254310-112	50	468
QS-577	244310-112	50	468
QS-578	244310-870	50	468
QS-579	230805-665	2	469

TROUVEZ LE BON SYSTEME DE FIXATION POUR VOTRE PROJET

Pensez à contrôler vos normes.











Il ne s'agit pas de Notes de Calcul ou de résultat de test mais uniquement d'indications basées sur l'expérience de Q-railing. Nos tableaux sont ici une aide au choix de la fixation. En cas de doute, merci de consulter notre service commercial. Notre offre vous aides dans le choix des fixations en cas de doute consultez notre service commercial.

Retrouvez toutes les informations sur Q-pac en ligne :











<https://q-ne.ws/QPac23>







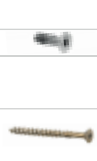





EASY GLASS® SMART / SMART+ / PRIME

Montage	t (mm)	Ancrage	QS	Type	Utilisation	Vis / boulon	QS	Type	Utilisation		
 MOD 8210 / 8410 MOD 8310	7 / 8,5	Chimique	POUR BÉTON				POUR ACIER				
			QS-276	QVMU-A M12x175	INDOOR		464	QS-224	M12 x 30	INDOOR	473
			QS-277	QVMU-A M12x175 A4	OUTDOOR		464	+ QS-216	Pour M12	INDOOR	473
			QS-207	QVMZ-IG 90 M12 A4	OUTDOOR		465	QS-223	M12 x 30	OUTDOOR	473
			+ QS-225	M12 x 45	OUTDOOR		473	+ QS-215	Pour M12	OUTDOOR	473
		Mécanique	+ QS-215	Pour M12	OUTDOOR	473	QS-225	M12 x 45	OUTDOOR	473	
			+ QS-215	Pour M12	OUTDOOR	473	+ QS-215	Pour M12	OUTDOOR	473	
			POUR BOIS				QS-258	10 x 120	INDOOR	469	
			QS-574	QBSZ SU 10x100	INDOOR		468	QS-290	10 x 100	OUTDOOR	469
			QS-575	QBSZ SU 10x100 A4	OUTDOOR		468				
			QS-576	QBSZ SU 10x120	INDOOR	468					
			QS-577	QBSZ SU 10x120 A4	OUTDOOR	468					
			QS-560	QSZ 12/10 A4	OUTDOOR	467					
			QS-561	QSZ-S 12/10	INDOOR	467					
			QS-562	QSZ 12/30 A4	OUTDOOR	467					
QS-563	QSZ-S 12/30	INDOOR	467								
 MOD 8220 / 8420	15 / 20	Chimique	POUR BÉTON				POUR ACIER				
			QS-276	QVMU-A M12x175	INDOOR		464	QS-225	M12 x 45	OUTDOOR	473
			QS-277	QVMU-A M12x175 A4	OUTDOOR		464	+ QS-215	Pour M12	OUTDOOR	473
			QS-207	QVMZ-IG 90 M12 A4	OUTDOOR		465				
			+ QS-225	M12 x 45	OUTDOOR		473	POUR BOIS			
		Mécanique	+ QS-215	Pour M12	OUTDOOR	473	QS-258	10 x 120	INDOOR	469	
			QS-562	QSZ 12/30 A4	OUTDOOR	467	QS-290	10 x 100	OUTDOOR	469	
			QS-563	QSZ-S 12/30	INDOOR	467					
			QS-576	QBSZ SU 10x120	INDOOR	468					
			QS-577	QBSZ SU 10x120 A4	OUTDOOR	468					
 MOD 8230 / 8430 MOD 8330	4 / 5	Chimique	POUR BÉTON				POUR ACIER				
			QS-207	QVMZ-IG 90 M12 A4	OUTDOOR		465	QS-224	M12 x 30	INDOOR	473
			+ QS-225	M12 x 45	OUTDOOR		473	+ QS-216	Pour M12	INDOOR	473
			+ QS-215	Pour M12	OUTDOOR		473	QS-223	M12 x 30	OUTDOOR	473
								+ QS-215	Pour M12	OUTDOOR	473
		Mécanique	QS-225	M12 x 45	OUTDOOR	473	QS-225	M12 x 45	OUTDOOR	473	
			+ QS-215	Pour M12	OUTDOOR	473	+ QS-215	Pour M12	OUTDOOR	473	
			POUR BOIS				QS-258	10 x 120	INDOOR	469	
			QS-571	QBSZ SK 10x100	INDOOR		468	QS-290	10 x 100	OUTDOOR	469
			+ QS-286	Pour QBSZ SK 10	INDOOR		468				
			QS-572	QBSZ SK 10x100 A4	OUTDOOR	468					
			+ QS-286	Pour QBSZ SK 10	OUTDOOR	468					
			QS-573	QBSZ SK 10x120 A4	OUTDOOR	468					
			+ QS-286	Pour QBSZ SK 10	OUTDOOR	468					
			QS-560	QSZ 12/10 A4	OUTDOOR	467					
QS-561	QSZ-S 12/10	INDOOR	467								
QS-562	QSZ 12/30 A4	OUTDOOR	467								
QS-563	QSZ-S 12/30	INDOOR	467								
 MOD 8240 / 8440	5 / 5	Chimique	POUR BÉTON				POUR ACIER				
			QS-276	QVMU-A M12x175	INDOOR		464	QS-224	M12 x 30	INDOOR	473
			QS-277	QVMU-A M12x175 A4	OUTDOOR		464	+ QS-216	Pour M12	INDOOR	473
			QS-207	QVMZ-IG 90 M12 A4	OUTDOOR		465	QS-223	M12 x 30	OUTDOOR	473
			+ QS-225	M12 x 45	OUTDOOR		473	+ QS-215	Pour M12	OUTDOOR	473
		Mécanique	+ QS-215	Pour M12	OUTDOOR	473	QS-225	M12 x 45	OUTDOOR	473	
			+ QS-215	Pour M12	OUTDOOR	473	+ QS-215	Pour M12	OUTDOOR	473	
			POUR BOIS				QS-258	10 x 120	INDOOR	469	
			QS-574	QBSZ SU 10x100	INDOOR		468	QS-290	10 x 100	OUTDOOR	469
			QS-575	QBSZ SU 10x100 A4	OUTDOOR		468				
			QS-576	QBSZ SU 10x120	INDOOR	468					
			QS-577	QBSZ SU 10x120 A4	OUTDOOR	468					
			QS-560	QSZ 12/10 A4	OUTDOOR	467					
			QS-561	QSZ-S 12/10	INDOOR	467					









EASY GLASS® SLIM

Montage	t (mm)	Ancrage	QS	Type	Utilisation	Vis / boulon	QS	Type	Utilisation		
 MOD 8010	12,5		POUR BÉTON				POUR ACIER				
			QS-36	Q SZ-SK 12/50	INDOOR		467	QS-531	M10 x 35	INDOOR	472
			QS-519	Q SZ-SK 12/50 A4	OUTDOOR		467	QS-530	M10 x 35	OUTDOOR	472
			QS-571	Q BSZ SK 10x100	INDOOR		468	POUR BOIS			
			QS-572	Q BSZ SK 10x100 A4	OUTDOOR		468				
QS-573	Q BSZ SK 10x120 A4	OUTDOOR	468	QS-251	10 x 120	INDOOR	469				
 MOD 8020	10,5		POUR BÉTON				POUR ACIER				
			QS-276	Q VMU-A M12x175	INDOOR		464	QS-223	M12 x 30	OUTDOOR	473
			QS-277	Q VMU-A M12x175 A4	OUTDOOR		464	+ QS-215	Pour M12	OUTDOOR	473
			QS-207	Q VMZ-IG 90 M12 A4	OUTDOOR		465	QS-225	M12 x 45	OUTDOOR	473
			+ QS-225	M12 x 45	OUTDOOR		473	+ QS-215	Pour M12	OUTDOOR	473
			+ QS-215	Pour M12	OUTDOOR		473	POUR BOIS			
			QS-562	Q SZ 12/30 A4	OUTDOOR		467				
			QS-563	Q SZ-S 12/30	INDOOR		467	QS-258	10 x 120	INDOOR	469
			QS-576	Q BSZ SU 10x120	INDOOR		468	QS-290	10 x 100	OUTDOOR	469
			QS-577	Q BSZ SU 10x120 A4	OUTDOOR		468				
 MOD 8030	7		POUR BÉTON				POUR ACIER				
			QS-36	Q SZ-SK 12/50	INDOOR		467	QS-74	M12 x 40	OUTDOOR	472
			QS-519	Q SZ-SK 12/50 A4	OUTDOOR		467	POUR BOIS			
			QS-571	Q BSZ SK 10x100	INDOOR		468				
			QS-572	Q BSZ SK 10x100 A4	OUTDOOR		468	QS-250	10 x 80	INDOOR	469
QS-573	Q BSZ SK 10x120 A4	OUTDOOR	468	QS-251	10 x 120	INDOOR	469				





EASY GLASS® PRO

Montage	t (mm)	Ancrage	QS	Type	Utilisation	Vis / boulon	QS	Type	Utilisation		
 MOD 8110	7,5		POUR BÉTON				POUR ACIER				
			QS-558	Q VMZ-IG 90 M12	INDOOR		465	QS-222	M12 x 30	INDOOR	473
			QS-557	Q VMZ-IG 90 M12 A4	OUTDOOR		465	+ QS-217	Pour M12	INDOOR	473
			QS-574	Q BSZ SU 10x100	INDOOR		468	QS-221	M12 x 30	OUTDOOR	473
			QS-575	Q BSZ SU 10x100 A4	OUTDOOR		468	+ QS-217	Pour M12	OUTDOOR	473
			QS-576	Q BSZ SU 10x120	INDOOR		468	POUR BOIS			
			QS-577	Q BSZ SU 10x120 A4	OUTDOOR		468				
			QS-560	Q SZ 12/10 A4	OUTDOOR		467	QS-258	10 x 120	INDOOR	469
QS-561	Q SZ-S 12/10	INDOOR	467	QS-290	10 x 100	OUTDOOR	469				
 MOD 8120	12		POUR BÉTON				POUR ACIER				
			QS-276	Q VMU-A M12x175	INDOOR		464	QS-219	M12 x 35	OUTDOOR	473
			QS-277	Q VMU-A M12x175 A4	OUTDOOR		464	+ QS-215	Pour M12	OUTDOOR	473
			QS-207	Q VMZ-IG 90 M12 A4	OUTDOOR		465	QS-225	M12 x 45	OUTDOOR	473
			+ QS-225	M12 x 45	OUTDOOR		473	+ QS-215	Pour M12	OUTDOOR	473
			+ QS-215	Pour M12	OUTDOOR		473	POUR BOIS			
			QS-562	Q SZ 12/30 A4	OUTDOOR		467				
			QS-563	Q SZ-S 12/30	INDOOR		467	QS-258	10 x 120	INDOOR	469
			QS-576	Q BSZ SU 10x120	INDOOR		468	QS-290	10 x 100	OUTDOOR	469
			QS-577	Q BSZ SU 10x120 A4	OUTDOOR		468				
 MOD 8130 / 8150	5,5 / 5,5		POUR BÉTON				POUR ACIER				
			QS-558	Q VMZ-IG 90 M12	INDOOR		465	QS-222	M12 x 30	INDOOR	473
			QS-557	Q VMZ-IG 90 M12 A4	OUTDOOR		465	+ QS-217	Pour M12	INDOOR	473
			QS-560	Q SZ 12/10 A4	OUTDOOR		467	QS-221	M12 x 30	OUTDOOR	473
			QS-561	Q SZ-S 12/10	INDOOR		467	+ QS-217	Pour M12	OUTDOOR	473
				POUR BOIS							
				QS-258	10 x 120	INDOOR	469				
				QS-290	10 x 100	OUTDOOR	469				
 MOD 8140	4,5		POUR BÉTON				POUR ACIER				
			QS-558	Q VMZ-IG 90 M12	INDOOR		465	QS-222	M12 x 30	INDOOR	473
			QS-557	Q VMZ-IG 90 M12 A4	OUTDOOR		465	+ QS-217	Pour M12	INDOOR	473
			QS-574	Q BSZ SU 10x100	INDOOR		468	QS-551	M12 x 40	INDOOR	472
			QS-575	Q BSZ SU 10x100 A4	OUTDOOR		468	+ QS-217	Pour M12	INDOOR	473
			QS-576	Q BSZ SU 10x120	INDOOR		468	QS-221	M12 x 30	OUTDOOR	473
			QS-577	Q BSZ SU 10x120 A4	OUTDOOR		468	+ QS-217	Pour M12	OUTDOOR	473
			QS-560	Q SZ 12/10 A4	OUTDOOR		467	POUR BOIS			
			QS-561	Q SZ-S 12/10	INDOOR		467				
							QS-258	10 x 120	INDOOR	469	
				QS-290	10 x 100	OUTDOOR	469				







EASY GLASS® MAX / STRONG

Montage	t (mm)	Ancrage	QS	Type	Utilisation	Vis / boulon	QS	Type	Utilisation	
Au sol  MOD 8510 MOD 8610	9,5	Chimique	POUR BÉTON				POUR ACIER			
			QS-208	Q VMZ-IG 90 M12	INDOOR		465	QS-224	M12 x 30	INDOOR
			+ QS-224	M12 x 30	INDOOR	473	+ QS-216	Pour M12	INDOOR	473
			+ QS-216	Pour M12	INDOOR	473	QS-223	M12 x 30	OUTDOOR	473
			QS-207	Q VMZ-IG 90 M12 A4	OUTDOOR	465	+ QS-215	Pour M12	OUTDOOR	473
			+ QS-219	M12 x 35	OUTDOOR	473	QS-225	M12 x 45	OUTDOOR	473
			+ QS-215	Pour M12	OUTDOOR	473	+ QS-215	Pour M12	OUTDOOR	473
Au sol F  MOD 8520	9,5	Chimique	POUR BÉTON				POUR ACIER			
			QS-276	Q VMU-A M12x175	INDOOR		464	QS-225	M12 x 45	OUTDOOR
			QS-277	Q VMU-A M12x175 A4	OUTDOOR	464	+ QS-215	Pour M12	OUTDOOR	473
			QS-207	Q VMZ-IG 90 M12 A4	OUTDOOR	465				
			+ QS-225	M12 x 45	OUTDOOR	473				
			+ QS-215	Pour M12	OUTDOOR	473				
Latéral  MOD 8530 MOD 8630	26,5	Chimique	POUR BÉTON				POUR ACIER			
			QS-208	Q VMZ-IG 90 M12	INDOOR		465	QS-224	M12 x 30	INDOOR
			+ QS-224	M12 x 30	INDOOR	473	+ QS-216	Pour M12	INDOOR	473
			+ QS-216	Pour M12	INDOOR	473	QS-223	M12 x 30	OUTDOOR	473
			QS-207	Q VMZ-IG 90 M12 A4	OUTDOOR	465	+ QS-215	Pour M12	OUTDOOR	473
			+ QS-219	M12 x 35	OUTDOOR	473	QS-225	M12 x 45	OUTDOOR	473
			+ QS-215	Pour M12	OUTDOOR	473	+ QS-215	Pour M12	OUTDOOR	473
Latéral Y  MOD 8540	8	Chimique	POUR BÉTON				POUR ACIER			
			QS-276	Q VMU-A M12x175	INDOOR		464	QS-224	M12 x 30	INDOOR
			QS-277	Q VMU-A M12x175 A4	OUTDOOR	464	+ QS-216	Pour M12	INDOOR	473
			QS-207	Q VMZ-IG 90 M12 A4	OUTDOOR	465	QS-219	M12 x 35	OUTDOOR	473
			+ QS-219	M12 x 35	OUTDOOR	473	+ QS-215	Pour M12	OUTDOOR	473
			+ QS-215	Pour M12	OUTDOOR	473	QS-225	M12 x 45	OUTDOOR	473
							+ QS-215	Pour M12	OUTDOOR	473



EASY GLASS® UP

Montage	t (mm)	Ancrage	QS	Type	Utilisation	Vis / boulon	QS	Type	Utilisation	
Au sol  MOD 6610	5,5	Chimique	POUR BÉTON				POUR ACIER			
			QS-558	Q VMZ-IG 90 M12	INDOOR		465	QS-221	M12 x 30	OUTDOOR
			QS-557	Q VMZ-IG 90 M12 A4	OUTDOOR	465	+ QS-217	Pour M12	OUTDOOR	473
		Mécanique	QS-560	Q SZ 12/10 A4	OUTDOOR	467				
			QS-561	Q SZ-S 12/10	INDOOR	467				
Latéral  MOD 6620	4,5	Chimique	POUR BÉTON				POUR ACIER			
			QS-558	Q VMZ-IG 90 M12	INDOOR		465	QS-221	M12 x 30	OUTDOOR
			QS-557	Q VMZ-IG 90 M12 A4	OUTDOOR	465	+ QS-217	Pour M12	OUTDOOR	473
		Mécanique	QS-560	Q SZ 12/10 A4	OUTDOOR	467				
			QS-561	Q SZ-S 12/10	INDOOR	467				





















EASY GLASS® PINCES À VERRE DE SOL

Montage	t (mm)	Ancrage	QS	Type	Utilisation	Vis / boulon	QS	Type	Utilisation	
MOD 6000 	12	Chimique	POUR BÉTON				POUR ACIER			
			QS-276	Q VMU-A M12x175	INDOOR		464	QS-551	M12 x 40	INDOOR
			QS-277	Q VMU-A M12x175 A4	OUTDOOR	464	+ QS-217	Pour M12	INDOOR	473
			QS-507	Q VMU-A M12x175	INDOOR	464	QS-221	M12 x 30	OUTDOOR	473
			QS-60	Q VMU-A M12x175 A4	OUTDOOR	464	+ QS-217	Pour M12	OUTDOOR	473
MOD 6400 	11,5	Chimique	POUR BÉTON				POUR ACIER			
			QS-507	Q VMU-A M12x175	INDOOR		464	QS-551	M12 x 40	INDOOR
			QS-60	Q VMU-A M12x175 A4	OUTDOOR	464	+ QS-217	Pour M12	INDOOR	473
			QS-276	Q VMU-A M12x175	INDOOR	464	QS-221	M12 x 30	OUTDOOR	473
			QS-277	Q VMU-A M12x175 A4	OUTDOOR	464	+ QS-217	Pour M12	OUTDOOR	473
			QS-559	Q VMZ-IG 105 M12 A4	OUTDOOR	465	QS-225	M12 x 45	OUTDOOR	473
							+ QS-215	Pour M12	OUTDOOR	473
MOD 6100 / 6200 	8 / 8	Chimique	POUR BÉTON				POUR BOIS			
			QS-207	Q VMZ-IG 90 M12 A4	OUTDOOR		465	QS-250	10 x 80	INDOOR
			+ QS-74	M12 x 40	OUTDOOR	472	QS-251	10 x 120	INDOOR	469
		Mécanique	QS-36	Q SZ-SK 12/50	INDOOR	467				
			QS-519	Q SZ-SK 12/50 A4	OUTDOOR	467				







EASY GLASS® AIR

Montage	t (mm)	Ancrage	QS		Type	Utilisation	☒	Vis / boulon	QS		Type	Utilisation	☒		
			Chimique	POUR BÉTON					POUR ACIER						
	10			QS-558	Q VMZ-IG 90 M12	INDOOR	465		POUR ACIER						
				QS-557	Q VMZ-IG 90 M12 A4	OUTDOOR	465		QS-222	M12 x 30				INDOOR	473
									+ QS-217	Pour M12				INDOOR	473
									QS-221	M12 x 30				OUTDOOR	473
								+ QS-217	Pour M12	OUTDOOR	473				

EASY GLASS® ADAPTATEURS À VERRE

Montage	t (mm)	Ancrage	QS		Type	Utilisation	☒	Vis / boulon	QS		Type	Utilisation	☒		
			Chimique	POUR BÉTON					POUR ACIER						
	5,5			QS-521	Q VMZ-IG 80 M10	INDOOR	465		POUR ACIER						
				+ QS-532	M10 x 30mm	INDOOR	472		QS-533	M10 x 30				OUTDOOR	472
				QS-520	Q VMZ-IG 80 M10 A4	OUTDOOR	465		QS-531	M10 x 35				INDOOR	472
				+ QS-533	M10 x 30mm	OUTDOOR	472		QS-530	M10 x 35				OUTDOOR	472
									POUR BOIS						
				QS-251	10 x 120	INDOOR	469								
	11			QS-507	Q VMZ-A 125 M12-25/170	INDOOR	464		POUR ACIER						
				QS-276	Q VMU-A M12x175	INDOOR	464		QS-551	M12 x 40				INDOOR	472
									+ QS-217	Pour M12				INDOOR	473
	7,5			QS-63	VMZ-A 50 M8-15/80	INDOOR	464		POUR ACIER						
				QS-62	Q VMZ-A 50 M8-15/80 A4	OUTDOOR	464		QS-29	M8 x 35				INDOOR	472
				QS-270	Q VMU-A M8x110	INDOOR	464		+ QS-287	Pour M8				INDOOR	473
				QS-271	Q VMU-A M8x110 A4	OUTDOOR	464		QS-30	M8 x 35				OUTDOOR	472
								+ QS-287	Pour M8	OUTDOOR	473				
	19,5			QS-528	Q VMZ-IG 75 M8	INDOOR	465		POUR ACIER						
				+ QS-29	M8 x 35mm	INDOOR	472		QS-29	M8 x 35				INDOOR	472
				+ QS-287	Pour M8	INDOOR	473		+ QS-287	Pour M8				INDOOR	473
	11			QS-272	Q VMU-A M10x130	INDOOR	464		POUR ACIER						
				QS-273	Q VMU-A M10x130 A4	OUTDOOR	464		QS-67	M10 x 40				INDOOR	472
									QS-72	M10 x 45				OUTDOOR	472
	9			QS-276	Q VMU-A M12x175	INDOOR	464		POUR ACIER						
				QS-277	Q VMU-A M12x175 A4	OUTDOOR	464		QS-551	M12 x 40				INDOOR	472
				QS-507	Q VMU-A M12x175	INDOOR	464		+ QS-217	Pour M12				INDOOR	473
				QS-60	Q VMU-A M12x175 A4	OUTDOOR	464		QS-221	M12 x 30				OUTDOOR	473
									+ QS-217	Pour M12	OUTDOOR	473			
	Optionnel				QS-560	Q SZ 12/10 A4	OUTDOOR	467							
					QS-561	Q SZ-S 12/10	INDOOR	467							
					QS-34	Q BZ 8 10-21/75 A4	OUTDOOR	467							
QS-35					Q BZ 8 10-21/75	INDOOR	467								







EASY GLASS® PROTECTION DE FENÊTRES - EASY GLASS® VIEW

Montage	t (mm)	Ancrage	QS	Type	Utilisation	Vis / boulon	QS	Type	Utilisation		
 MOD 6839 / 6830 MOD 6849	4,5	 Chimique	POUR BÉTON		OUTDOOR		POUR ACIER				
			QS-529	Q VMZ-IG 75 M8			465	QS-27	M8 x 20	OUTDOOR	472
			+ QS-27	M8 x 20			472	QS-30	M8 x 35	OUTDOOR	472
		 Autre	POUR BÉTON		OUTDOOR		POUR BOIS				
			QS-266	5,5 x 50			469	QS-264	6 x 80	OUTDOOR	469
		 Mécanique	QS-579	M16 x 65	469						

EASY GLASS® PROTECTION DE FENÊTRES - MOD 6507-6508

















Montage	t (mm)	Ancrage	QS	Type	Utilisation	Vis / boulon	QS	Type	Utilisation	
 MOD 6507 / 6508	4	 Chimique	POUR BÉTON		OUTDOOR		POUR ACIER			
			QS-64	Q VMZ-A 60 M10-10/85 A4			464	QS-72	M10 x 45	OUTDOOR
			 Mécanique	QS-273	Q VMU-A M10x130 A4	464				
					QS-58	Q BZ 10 10-30/90 A4	467			

EASY GLASS® PROTECTION DE FENÊTRES AVEC ADAPTATEURS À VERRE



Montage	t (mm)	Ancrage	QS	Type	Utilisation	Vis / boulon	QS	Type	Utilisation		
 MOD 0749	5,5	 Chimique	POUR BÉTON		OUTDOOR		POUR ACIER				
			QS-520	Q VMZ-IG 80 M10 A4			465	QS-533	M10 x 30	OUTDOOR	472
			+ QS-533	M10 x 30mm			472	QS-530	M10 x 35	OUTDOOR	472
 MOD 0763	9	 Chimique	POUR BÉTON		OUTDOOR		POUR ACIER				
			QS-277	Q VMU-A M12x175 A4			464	QS-221	M12 x 30	OUTDOOR	473
			 Mécanique	QS-60	Q VMU-A M12x175 A4	464	+ QS-217	Pour M12	OUTDOOR	473	
				QS-560	Q SZ 12/10 A4	467					
				QS-34*	Q BZ 8 10-21/75 A4	467					

*Optionnel



BARRES D'APPUI

Montage	t (mm)	Ancrage	QS	Type	Utilisation	Vis / boulon	QS	Type	Utilisation
 MOD 4828	7	 Chimique	POUR BÉTON		OUTDOOR		POUR ACIER		
			QS-529	Q VMZ-IG 75 M8			465	QS-20	M8 x 25
			 Autre	QS-579	M16 x 65	469			
 MOD 0842 MOD 0843	14,5	 Chimique	POUR BÉTON		OUTDOOR		POUR ACIER		
			QS-529	Q VMZ-IG 75 M8			465	QS-22	M8 x 40
			 Autre	QS-579	M16 x 65	469			
 MOD 6517	4	 Chimique	POUR BÉTON		OUTDOOR		POUR ACIER		
			QS-529	Q VMZ-IG 75 M8			465	QS-27	M8 x 20
			 Autre	QS-579	M16 x 65	469			
 MOD 6518	4	 Chimique	POUR BÉTON		OUTDOOR		POUR ACIER		
			QS-529	Q VMZ-IG 75 M8			465	QS-27	M8 x 20
			 Autre	QS-579	M16 x 65	469			



EASY ALU

Montage	t (mm)	Ancrage	QS	Type	Utilisation	Vis / boulon	QS	Type	Utilisation	
Au sol  MOD 9026	26	Chimique	POUR BÉTON				POUR BOIS			
			QS-284	Q VMU-A M12 x 265	INDOOR		464	QS-255	8 x 80	INDOOR
			QS-285	Q VMU-A M12 x 265	OUTDOOR	464				
Latéral  MOD 9028-120-00  MOD 9028-120-90	8	Chimique	POUR BÉTON				POUR BOIS			
			QS-276	Q VMU-A M12x175	INDOOR		464	QS-255	8 x 80	INDOOR
				QS-277	Q VMU-A M12x175 A4	OUTDOOR	464			
	20	Mécanique	QS-574	Q BSZ SU 10x100	INDOOR	468				
			QS-575	Q BSZ SU 10x100 A4	OUTDOOR	468				
			QS-576	Q BSZ SU 10x120	INDOOR	468				
QS-577			Q BSZ SU 10x120 A4	OUTDOOR	468					



















SQUARE LINE® 40x40

Pour	t (mm)	Ancrage	QS	Type	Utilisation			
Au sol  MOD 4921 / 4972  MOD 4942 / 4940	8	Chimique	POUR BÉTON					
			QS-65	Q VMZ-A 60 M10-10/85	INDOOR		464	
					QS-64	Q VMZ-A 60 M10-10/85 A4	OUTDOOR	464
		Mécanique	QS-59	Q BZ 10 10-30/90	INDOOR	467		
			QS-58	Q BZ 10 10-30/90 A4	OUTDOOR	467		

SQUARE LINE® 60x30

Pour	t (mm)	Ancrage	QS	Type	Utilisation	
Au sol  MOD 4901 / 3503	11	Chimique	POUR BÉTON			
			QS-559	Q VMZ-IG 105 M12 A4	OUTDOOR	
		Mécanique	QS-577	Q BSZ SU 10x120 A4	OUTDOOR	468
Latéral  MOD 4558	11	Chimique	POUR BÉTON			
			QS-63	Q VMZ-A 50 M8-15/80	INDOOR	
			QS-62	Q VMZ-A 50 M8-15/80 A4	OUTDOOR	464

Q-LINE

Montage	t (mm)	Ancrage	QS	Type	Utilisation	Vis / boulon	QS	Type	Utilisation		
Au sol											
 MOD 3504	10	Chimique	POUR BÉTON		OUTDOOR						
			QS-273	Q VMU-A M10 x 130						464	
		Mécanique									
			QS-58	Q BZ 10 10-30/90	OUTDOOR			467			
			QS-578	Q BSZ SU 8 x 70 A4	OUTDOOR			468			
Au sol											
 MOD 0948 MOD 0949	12							POUR ACIER			
			QS-223	M12 x 30	OUTDOOR	473					
			+ QS-217	Pour M12	OUTDOOR			473			
			QS-219	M12 x 35	OUTDOOR			473			
			+ QS-217	Pour M12	OUTDOOR			473			
			QS-225	M12 x 40	OUTDOOR			473			
			+ QS-217	Pour M12	OUTDOOR			473			
Au sol											
 MOD 0921 / 9921 MOD 0962 / 0940	8	Chimique	POUR BÉTON		INDOOR						
			QS-65	Q VMZ-A 60 M10-10/85						464	
			QS-64	Q VMZ-A 60 M10-10/85 A4						OUTDOOR	464
		Mécanique									
			QS-59	Q BZ 10 10-30/90						INDOOR	467
			QS-58	Q BZ 10 10-30/90 A4	OUTDOOR			467			
Au sol											
 MOD 0912 / 3502	8	Chimique	POUR BÉTON		INDOOR						
			QS-63	VMZ-A 50 M8-15/80						464	
			QS-62	Q VMZ-A 50 M8-15/80 A4						OUTDOOR	464
		Mécanique									
			QS-35	Q BZ 8 10-21/75						INDOOR	467
			QS-34	Q BZ 8 10-21/75 A4	OUTDOOR			467			
Au sol											
 MOD 0916 / 0917 / 3505	13,5	Chimique	POUR BÉTON		INDOOR						
			QS-272	Q VMU-A M10 x 130						464	
			QS-273	Q VMU-A M10 x 130						OUTDOOR	464
Latéral											
 MOD 3508	10	Chimique	POUR BÉTON		OUTDOOR						
			QS-275	Q VMU-A M12 x 155						464	
		Mécanique									
			QS-560	Q SZ 12/10 A4						OUTDOOR	467
			QS-562	Q SZ 12/30 A4						OUTDOOR	467
Latéral											
 MOD 0557 MOD 0555 0551 / 0552	11	Chimique	POUR BÉTON		INDOOR						
			QS-33	Q VMZ-A 75 M12-25/120						464	
			QS-32	Q VMZ-A 75 M12-25/120 A4						OUTDOOR	464
Latéral											
 MOD 0558	10,5	Chimique	POUR BÉTON		INDOOR						
			QS-33	Q VMZ-A 75 M12-25/120						464	
			QS-275	Q VMU-A M12x155						OUTDOOR	464
Latéral											
 MOD 0556	20	Chimique	POUR BÉTON		INDOOR						
			QS-505	Q VMZ-IG 105 M12						465	
			+ QS-551	M12 x 40						INDOOR	472
			+ QS-217	Für M12						INDOOR	473
POUR ACIER											
			QS-551	M12 x 40	INDOOR			472			

Ancrages chimiques pour béton



MOD 4410

Zingué

INDOOR	QS	Type	d		L	
254410-811	QS-270	QVMU-A M8x110	M8	Ø 10	110	10
254410-820	QS-281	QVMU-A M8x205	M8	Ø 10	205	10
254410-113	QS-272	QVMU-A M10x130	M10	Ø 12	130	10
254410-215	QS-274	QVMU-A M12x155	M12	Ø 14	155	10
254410-217	QS-276	QVMU-A M12x175	M12	Ø 14	175	10
254410-226	QS-284	QVMU-A M12x265	M12	Ø 14	265	10

316

OUTDOOR

244410-811	QS-271	QVMU-A M8x110	M8	Ø 10	110	10
244410-820	QS-282	QVMU-A M8x205	M8	Ø 10	205	10
244410-113	QS-273	QVMU-A M10x130	M10	Ø 12	130	10
244410-215	QS-275	QVMU-A M12x155	M12	Ø 14	155	10
244410-217	QS-277	QVMU-A M12x175	M12	Ø 14	175	10
244410-226	QS-285	QVMU-A M12x265	M12	Ø 14	265	10

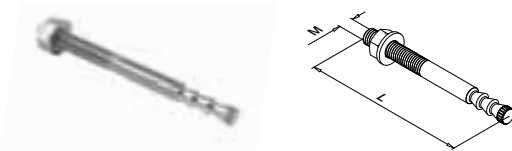

MOD 4010

Zingué

INDOOR	QS	Type		L	
254010-880	QS-63	QVMZ-A 50 M8-15/80	Ø 10	80	10
254010-185	QS-65	QVMZ-A 60 M10-10/85	Ø 12	85	10
254010-212	QS-33	QVMZ-A 75 M12-25/120	Ø 14	120	10
254010-217	QS-507	QVMZ-A 125 M12-25/170	Ø 14	170	10

316

OUTDOOR

244010-880	QS-62	QVMZ-A 50 M8-15/80 A4	Ø 10	80	10
244010-185	QS-64	QVMZ-A 60 M10-10/85 A4	Ø 12	85	10
244010-212	QS-32	QVMZ-A 75 M12-25/120 A4	Ø 14	120	10
244010-213	QS-549	QVMZ-A75 M12-40/135 A4	Ø 14	135	10
244010-217	QS-60	QVMZ-A 125 M12-25/170 A4	Ø 14	170	10



Q-INFO | MOD 4410

Informations sur l'assemblage Q-anchor VMU-A

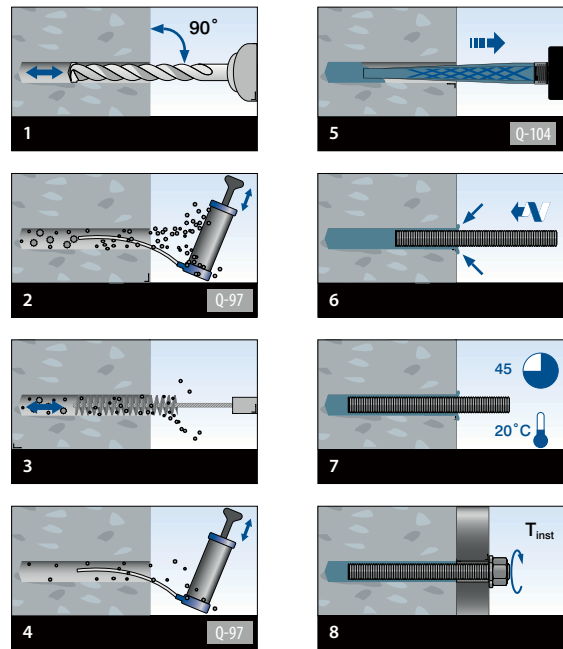

Q-INFO | MOD 4010

Informations sur l'assemblage Q-anchor VMZ-A

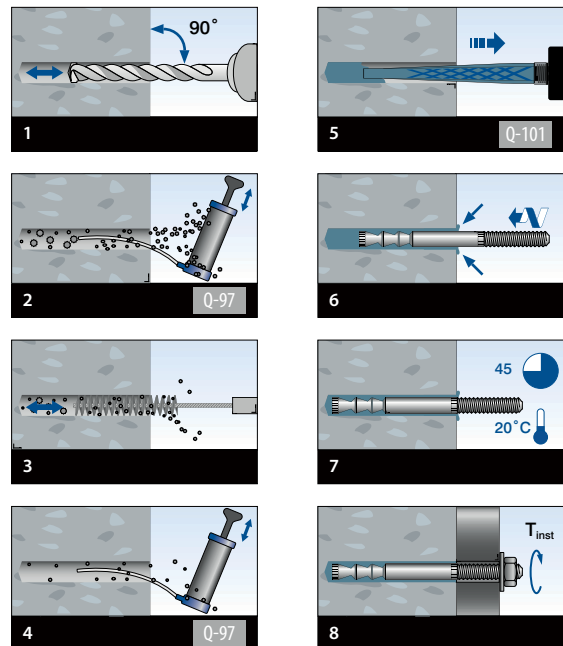

Ancrages chimiques pour béton



MOD 4510

Zingué

INDOOR	QS	Type	d		L	
254510-875	QS-528	QVMZ-IG 75 M8	M8	Ø 12	78	10
254510-180	QS-521	QVMZ-IG 80 M10	M10	Ø 14	84	10
254510-290	QS-208	QVMZ-IG 90 M12	M12	Ø 18	94	10
254510-210	QS-505	QVMZ-IG 105 M12	M12	Ø 18	109	10
254510-212	QS-212	QVMZ-IG 125 M12	M12	Ø 18	130	10

316

OUTDOOR

244510-875	QS-529	QVMZ-IG 75 M8	M8	Ø 12	78	10
244510-180	QS-520	QVMZ-IG 80 M10 A4	M10	Ø 14	84	10
244510-290	QS-207	QVMZ-IG 90 M12 A4	M12	Ø 18	94	10
244510-212	QS-211	QVMZ-IG 125 M12 A4	M12	Ø 18	130	10

Q-INFO MOD 4510

Informations sur l'assemblage Q-anchor VMZ-IG

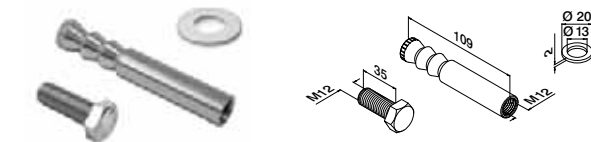
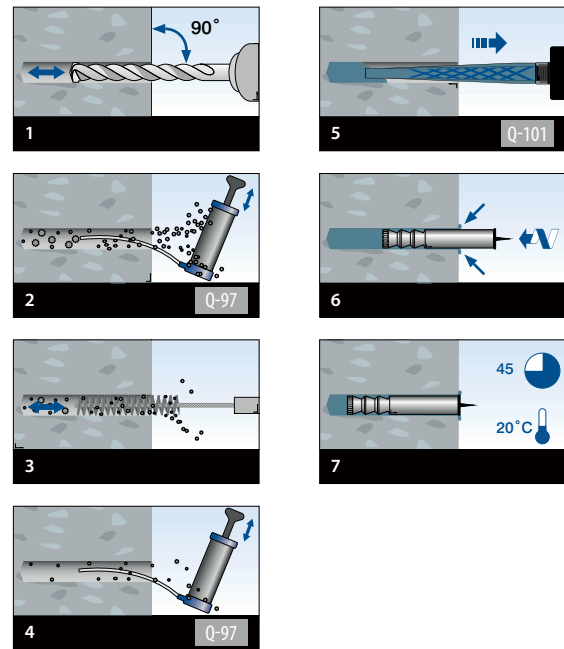

MOD 4519

316

OUTDOOR

INDOOR	QS	Type		
244519-210	QS-559	QVMZ-IG 105 M12 A4	Ø 18	10

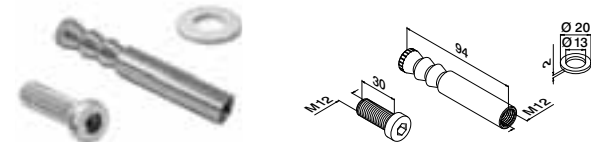

MOD 4519

Zingué

INDOOR	QS	Type		
254519-290	QS-558	QVMZ-IG 90 M12	Ø 18	10

316

OUTDOOR

244519-290	QS-557	QVMZ-IG 90 M12 A4	Ø 18	10
------------	--------	-------------------	------	----



Q-INFO MOD 4519

Informations sur l'assemblage Q-anchor VMZ-IG

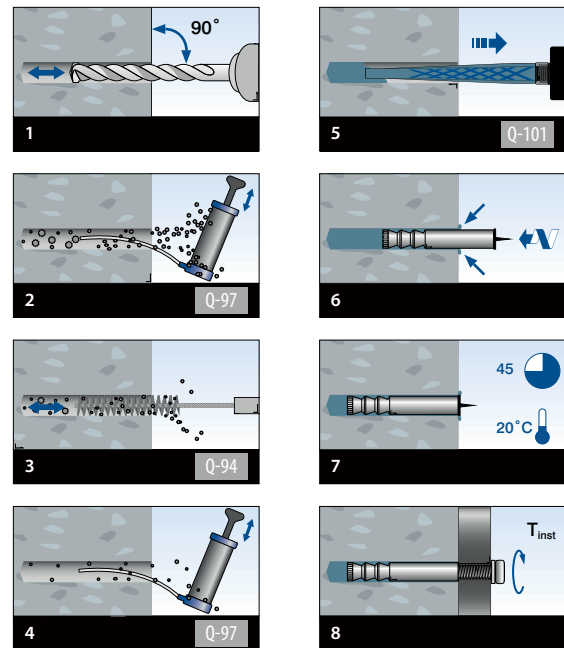



Accessoires pour scellement chimique



Mortier de scellement

MOD 4089 / 4090

Accessoires

	Q	e		
204089-28	Q-104	280 ml	Q-VMU-A	1
NEW 204089-30	Q-104	300 ml	Q-VMU-A	1
204090-28	Q-101	280 ml	Q-VMZ	1
NEW 204090-30	Q-101	300 ml	Q-VMZ	1



Pompe à air pour nettoyer les trous de perçage

MOD 4092

Accessoires



	Q	
204092	Q-97	1



Brosse de nettoyage pour nettoyer les trous de perçage

MOD 4093

Accessoires

	Q		
204093-010	Q-91	Ø 10	1
204093-012	Q-92	Ø 12	1
204093-014	Q-93	Ø 14	1
204093-018	Q-94	Ø 18	1
204093-020	Q-95	Ø 20	1



Bec mélangeur pour résine d'injection

MOD 4091

Accessoires

	Q	
204091	Q-103	1



Extension pour bec mélangeur, 200 mm, pour mortier de scellement VMZ 280/300

MOD 4096

Accessoires

	Q	
204096	Q-88	1



Extension pour brosse de nettoyage, 150 mm, avec rallonge filetage M6

MOD 4094

Accessoires

	Q	
204094	Q-89	1



Pistolet à silicone pour résine d'injection

MOD 4095

Accessoires

	Q	
204095	Q-102	1

Q-INFO | MOD 4089 / 4090

Nombre de remplissages de trous de forage par cartouche de résine d'injection

	VMZ-A	QS-32	QS-33	QS-60	QS-62	QS-63	QS-64	QS-65	QS-507	QS-549				
Q-101 (280 ml)	34	34	24	58	58	39	39	24	34		Q-101 / Q-104 280 ml			
Q-101 (300 ml)	36	36	25	62	62	41	41	25	36		204090-28 204089-28			
	VMZ-IG	QS-207	QS-208	QS-211	QS-212	QS-505	QS-520	QS-521	QS-528	QS-557	QS-558	QS-559		
Q-101 (280 ml)	21	21	16	16	19	27	27	34	21	21	19		Q-101 / Q-104 300 ml	
Q-101 (300 ml)	22	22	17	17	20	29	29	36	22	22	20		204090-30 204089-30	
	VMU-A	QS-270	QS-271	QS-281	QS-282	QS-272	QS-273	QS-274	QS-275	QS-276	QS-277	QS-284	QS-285	
Q-104 (280 ml)	46	46	40	40	32	32	22	22	22	22	19	19		
Q-104 (300 ml)	50	50	42	42	34	34	23	23	23	23	20	20		



Ancrages mécaniques pour béton



MOD 4110

Zingué

INDOOR	QS	Type	d	Ø	L	Ø
254110-875	QS-35	Q BZ 8 10-21/75	M8	Ø 8	75	10
254110-190	QS-59	Q BZ 10 10-30/90	M10	Ø 10	90	10

316

OUTDOOR

244110-875	QS-34	Q BZ 8 10-21/75 A4	M8	Ø 8	75	10
244110-190	QS-58	Q BZ 10 10-30/90 A4	M10	Ø 10	90	10



Q-INFO MOD 4110

Informations sur l'assemblage Q-anchor BZ Plus 8 & BZ Plus 10

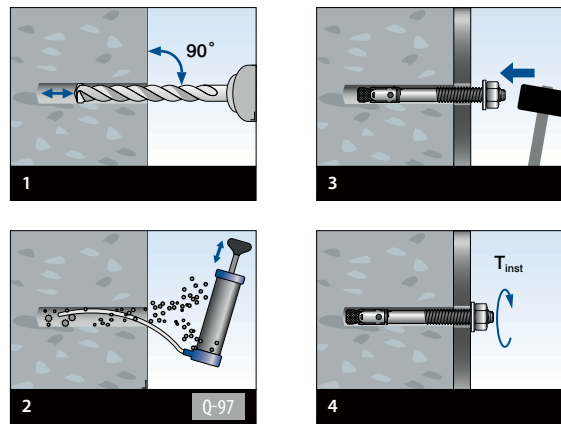

MOD 4210

Zingué

INDOOR	QS	Type	Ø	Ø	L	Ø
254210-212	QS-36	Q SZ-SK 12/50	12	Ø 12	120	25

316

OUTDOOR

244210-212	QS-519	Q SZ-SK 12/50 A4	12	Ø 12	120	25
------------	--------	------------------	----	------	-----	----



Q-INFO MOD 4210

Informations sur l'assemblage Q-anchor SZ-SK 12/50

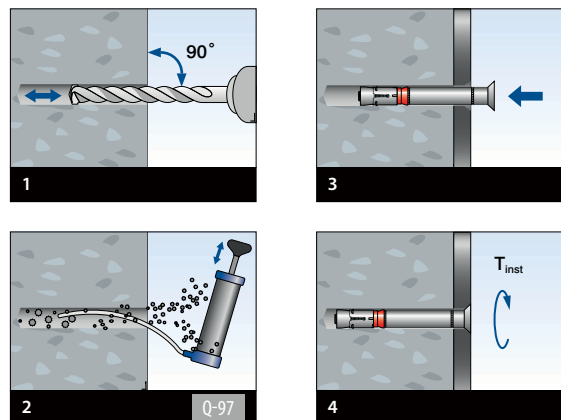

MOD 4220

Zingué

INDOOR	QS	Type	Ø	Ø	L	Ø
254220-285	QS-561	Q SZ-S 12/10	12	Ø 12	85	25
254220-211	QS-563	Q SZ-S 12/30	12	Ø 12	105	25

316

OUTDOOR

244220-285	QS-560	Q SZ-S 12/10 A4	12	Ø 12	85	25
244220-211	QS-562	Q SZ-S 12/30 A4	12	Ø 12	105	25



Q-INFO MOD 4220

Informations sur l'assemblage Q-anchor SZ-S 12/10-30

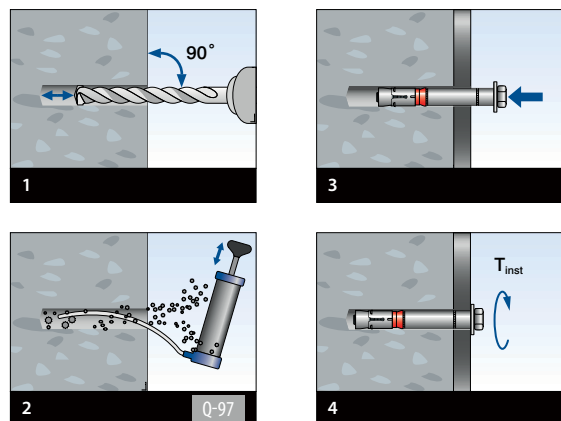

Vis à béton



MOD 4310

Zingué

INDOOR	QS	Type	Ø	L	50
254310-110	QS-574	Q BSZ SU 10x100	10	100	50
254310-112	QS-576	Q BSZ SU 10x120	10	120	50

316

OUTDOOR

244310-110	QS-575	Q BSZ SU 10x100 A4	10	100	50
244310-112	QS-577	Q BSZ SU 10x120 A4	10	120	50
NEW 244310-870	QS-578	Q-BSZ SU 8x70 A4	8	70	50



MOD 4300

Zingué

INDOOR	QS	Type	Q	Ø	L	50
254300-110	QS-571	Q BSZ SK 10x100	114	10	100	50

316

OUTDOOR

244300-110	QS-572	Q BSZ SK 10x100 A4	114	10	100	50
244300-112	QS-573	Q BSZ SK 10x120 A4	114	10	120	50



MOD 0665

316

OUTDOOR

QS	Pour d	50	
240665-232	QS-286	M12	25

VIS

ACCESSOIRES

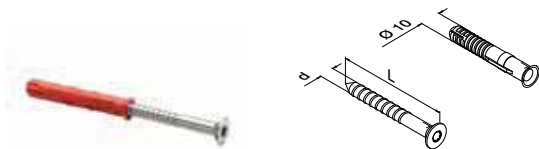

MOD 4250

316

OUTDOOR

QS	d	L	50	
244250-180	QS-214	7	80	50



Q-INFO MOD 4310

Informations sur l'assemblage Q-anchor Q BSZ SU 10x100 + 10x120 (A4)

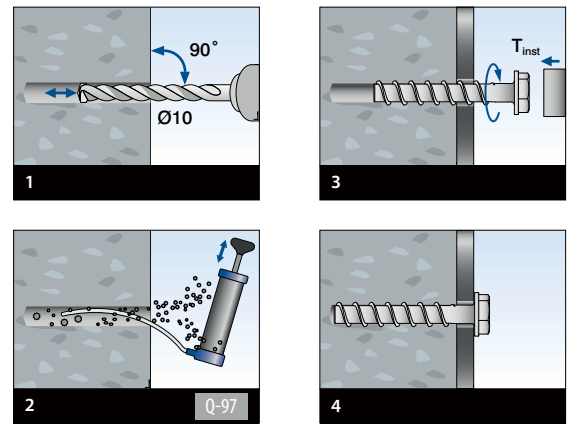

Q-INFO MOD 4300

Informations sur l'assemblage Q-anchor Q BSZ SK 10x100 + 10x120 (A4)

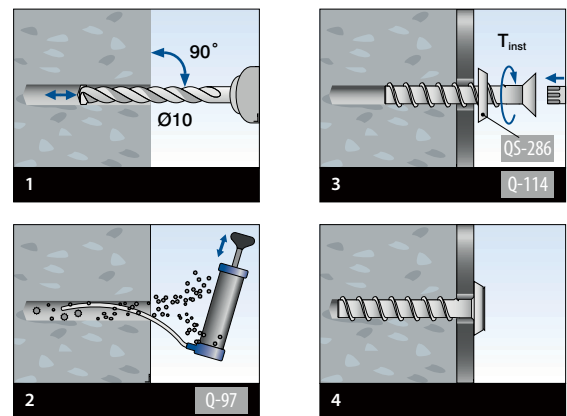

MOD 4260

316

OUTDOOR

QS	d	L	50	
244260-180	QS-213	7	80	50



Vis

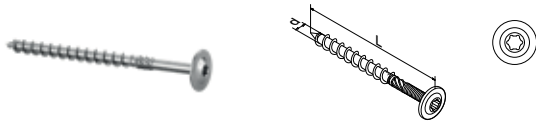

MOD 0250

Zingué

INDOOR	QS	Q	d	L	☐
250250-808	QS-255	Q-113	8	80	50
250250-812	QS-256	Q-113	8	120	50
250250-012	QS-258	Q-114	10	120	50

304

INDOOR

230250-608	QS-264	Q-115	6	80	50
230250-610	QS-265	Q-115	6	100	50



Q-INFO MOD 0250

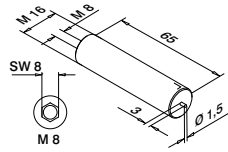
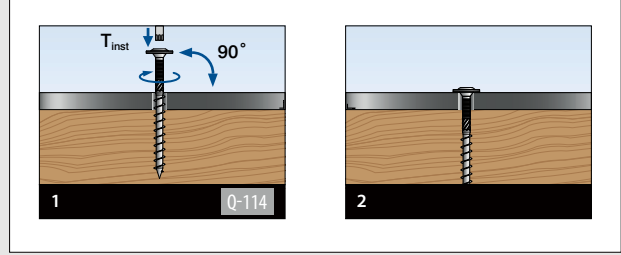

MOD 0805

316

OUTDOOR

QS	Q	d	Ø	L	☐	
230805-665	QS-579	Q-8	M8	M16	65	2



Q-INFO MOD 0805

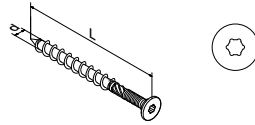
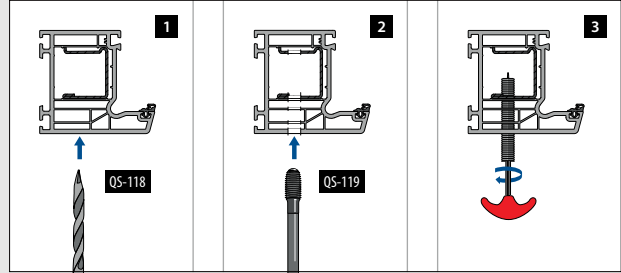

MOD 0260

Zingué

INDOOR	QS	Q	d	L	☐
250260-008	QS-250	Q-113	10	80	50
250260-012	QS-251	Q-113	10	120	50

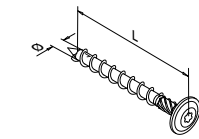

MOD 0251

Zingué C4

OUTDOOR	QS	d	L	☐
250251-010	QS-290	10	100	25

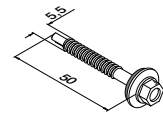

MOD 0915

316

OUTDOOR

QS	☐	
240915-550	QS-266	50



Embout 1/4", 5/16" propulsion

MOD 1016

Accessoires

	Q	Ø	AW	L	☐
201016-230	Q-115	1/4"	30	25	1
201016-240	Q-113	1/4"	40	26	1
201016-550	Q-114	5/16"	50	50	1

Q-INFO MOD 0915

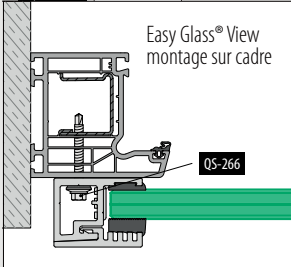

Q-INFO MOD 0805

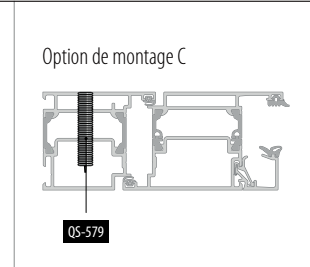
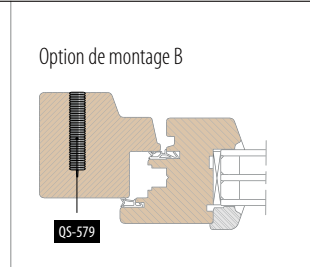
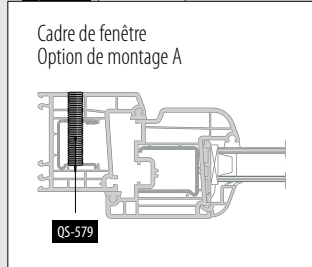

Chevilles



MOD 0841

Accessoires				
	QS	Ø	L	
200841-635	QS-87	6	35	100
200841-160	QS-555	10	60	50

SELL OUT



MOD 0843

Zingué				
IN/OUTDOOR	QS	Pour		
200843-008	QS-570	M8		25

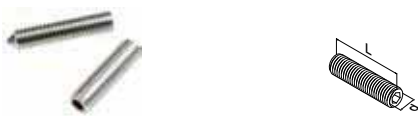

MOD 0491 - DIN 914 / ISO 4027

304					
INDOOR	QS	Q	d	L	
230491-850	QS-288	4	M8	50	50



MOD 0851

Laiton				
IN/OUTDOOR	QS			
200851-827	QS-55			50

CHEVILLES
ACCESSOIRES

Q-INFO | MOD 0841

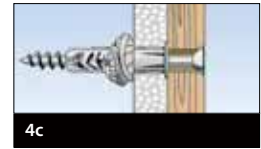
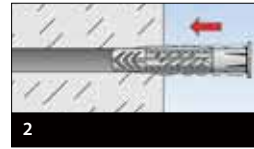

Q-INFO | MOD 0843 / 0491

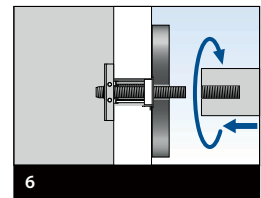
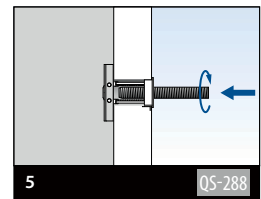
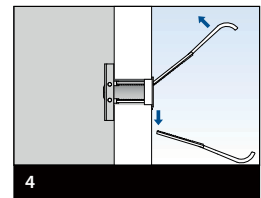
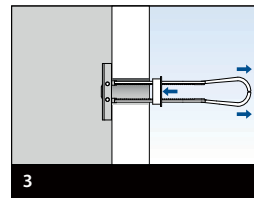
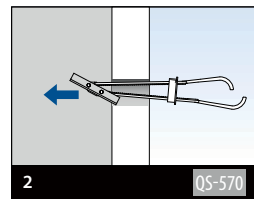
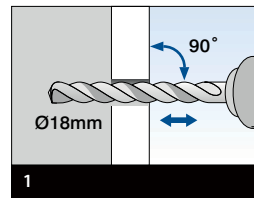

Q-INFO | MOD 0851

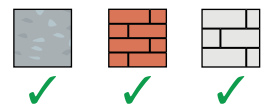
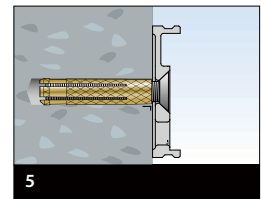
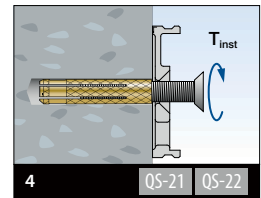
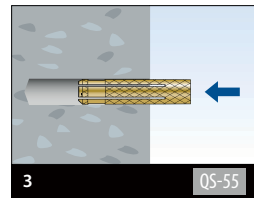
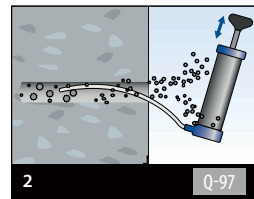
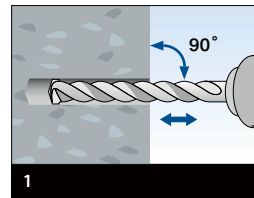

SELL OUT Seulement jusqu'à épuisement des stocks.

Vis

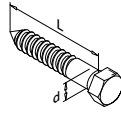

MOD 0200 - DIN 571

304

INDOOR	QS	d	L	
230200-760	QS-3	7	60	50

316

OUTDOOR				
240200-760	QS-4	7	60	50
240200-890	QS-556	8	90	50

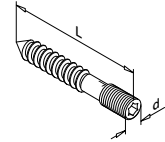

MOD 0205

304

INDOOR	QS	Q	d	L	
230205-050	QS-1	Q-4	M8 x 12	50	50
230205-090	QS-85	Q-4	M8 x 33	90	50

316

OUTDOOR					
240205-050	QS-2	Q-4	M8 x 12	50	50
240205-090	QS-86	Q-4	M8 x 33	90	50

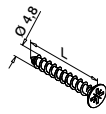

MOD 0210 - DIN 7982 C-H

304

INDOOR	QS	L	
230210-025	QS-5	25	50
230210-038	QS-7	38	50
230210-060	QS-503	60	50

316

OUTDOOR			
240210-025	QS-6	25	50
240210-038	QS-50	38	50
240210-060	QS-504	60	50

SELL
OUT

MOD 0240

304

INDOOR	QS	L	
230240-412	QS-200	12	50

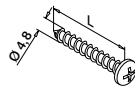

MOD 0230 - DIN 7981 C-H

304

INDOOR	QS	L	
230230-025	QS-8	25	50
230230-038	QS-56	38	50

316

OUTDOOR			
240230-025	QS-9	25	50
240230-038	QS-57	38	50

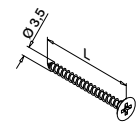

MOD 0211 - DIN 7997

304

INDOOR	QS	L	
230211-340	QS-49	40	50

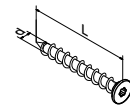

MOD 0212 - ISO 14586

316

OUTDOOR	QS	d	L	
240212-413	QS-268	4,2	13	50
240212-438	QS-267	4,2	38	50



Vis

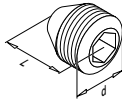

MOD 0400 - DIN 916 / ISO 4029

304					
INDOOR	QS	Q	d	L	☐
230400-505	QS-91	Q-2,5	M5	5	50
316					
OUTDOOR					
240400-505	QS-90	Q-2,5	M5	5	50
240400-610	QS-92	Q-3	M6	10	50

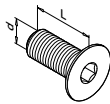

MOD 0670 - DIN 7991

304					
INDOOR	QS	Q	d	L	☐
230670-520	QS-12	Q-3	M5	20	50
230670-612	QS-48	Q-4	M6	12	50
230670-620	QS-14	Q-4	M6	20	50
230670-625	QS-15	Q-4	M6	25	50
230670-630	QS-17	Q-4	M6	30	50
230670-825	QS-19	Q-5	M8	25	50
230670-840	QS-21	Q-5	M8	40	50
230670-130	QS-532	Q-6	M10	30	50
230670-135	QS-531	Q-6	M10	35	50
316					
OUTDOOR					
240670-520	QS-13	Q-3	M5	20	50
240670-608	QS-205	Q-4	M6	8	50
240670-612	QS-89	Q-4	M6	12	50
240670-625	QS-16	Q-4	M6	25	50
240670-630	QS-18	Q-4	M6	30	50
240670-825	QS-20	Q-5	M8	25	50
240670-840	QS-22	Q-5	M8	40	50
240670-130	QS-533	Q-6	M10	30	50
240670-135	QS-530	Q-6	M10	35	50
240670-240	QS-74	Q-8	M12	40	50

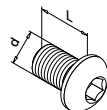

MOD 0690 - ISO 7380

304					
INDOOR	QS	Q	d	L	☐
230690-510	QS-202	Q-3	M5	10	50
230690-516	QS-10	Q-3	M5	16	50
230690-616	QS-83	Q-4	M6	16	50
316					
OUTDOOR					
240690-510	QS-203	Q-3	M5	10	50
240690-516	QS-11	Q-3	M5	16	50
240690-608	QS-261	Q-4	M6	8	50
240690-616	QS-84	Q-4	M6	16	50

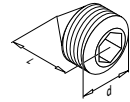

MOD 0490 - DIN 914 / ISO 4027

304					
INDOOR	QS	Q	d	L	☐
230490-506	QS-94	Q-2,5	M5	6	50
316					
OUTDOOR					
240490-506	QS-93	Q-2,5	M5	6	50

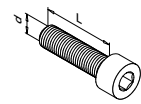

MOD 0680 - DIN 912 / ISO 4762

Zingué					
INDOOR	QS	Q	d	L	☐
250680-820	QS-28	Q-6	M8	20	50
304					
INDOOR	QS	Q	d	L	☐
230680-620	QS-23	Q-5	M6	20	50
230680-635	QS-24	Q-5	M6	35	50
230680-645	QS-54	Q-5	M6	45	50
230680-660	QS-25	Q-5	M6	60	50
230680-820	QS-26	Q-6	M8	20	50
230680-835	QS-29	Q-6	M8	35	50
230680-140	QS-67	Q-8	M10	40	50
230680-240	QS-551	-	M12	40	50
316					
OUTDOOR					
240680-620	QS-53	Q-5	M6	20	50
240680-645	QS-70	Q-5	M6	45	50
240680-660	QS-71	Q-5	M6	60	50
240680-820	QS-27	Q-6	M8	20	50
240680-835	QS-30	Q-6	M8	35	50
240680-140	QS-72	Q-8	M10	45	50

SEAL OUT



Boulons

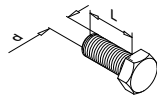

MOD 0661 - DIN 933

Zingué

INDOOR	QS	d	L	
250661-230	QS-224	M12	30	50

316

OUTDOOR

240661-230	QS-223	M12	30	50
240661-235	QS-219	M12	35	50
240661-245	QS-225	M12	45	50

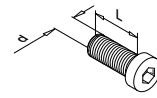

MOD 0662 - DIN 7984

Zingué

INDOOR	QS	Q	d	L	
250662-230	QS-222	Q-8	M12	30	50

316

OUTDOOR

240662-230	QS-221	Q-8	M12	30	50
------------	--------	-----	-----	----	----



Rondelles de calage

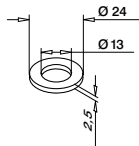

MOD 0663 - DIN 125A / ISO 7089

Zingué

INDOOR	QS	Pour d	
250663-224	QS-216	M12	50

316

OUTDOOR

240663-224	QS-215	M12	50
------------	--------	-----	----

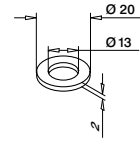

MOD 0664 - DIN 433 / ISO 7092

316

OUTDOOR	QS	Pour d	
240664-220	QS-217	M12	50

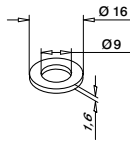

MOD 0666 - DIN 125A / ISO 7089

316

OUTDOOR

OUTDOOR	QS	Pour d	
240666-816	QS-287	M8	50

Ecroû

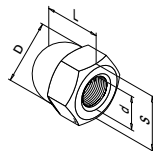

MOD 0650 - DIN 1587

304

INDOOR	QS	S	d	D	L	
230650-865	QS-514	13	M8	12,5	15	50
230650-108	QS-517	17	M10	16	18	50
230650-210	QS-518	19	M12	18	22	50

316

OUTDOOR

240650-865	QS-513	13	M8	12,5	15	50
240650-108	QS-515	17	M10	16	18	50
240650-210	QS-516	19	M12	18	22	50

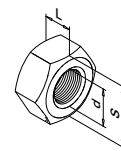

MOD 0651 - DIN 934

316

OUTDOOR	QS	S	d	L	
240651-208	QS-289	19	M12	10	50

SELL
OUT

Matériel de fixation pour pinces à verre

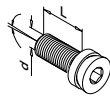

Boulons réglables
+/- 5°

MOD 0681

Pour tous modèles de pinces à verre en zamak

Zingué					
INDOOR	QS	Q	d	L	
250681	QS-46	Q-5	M8	20	50

Pour tous modèles de pinces à verre en 304

304					
INDOOR	QS	Q	d	L	
230681	QS-47	Q-5	M8	20	50

Pour tous modèles de pinces à verre en 316

316					
OUTDOOR	QS	Q	d	L	
240681	QS-45	Q-5	M8	20	50

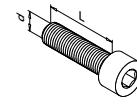

Vis 6-pans - tête cylindrique

MOD 0680 - DIN 912 / ISO 4762

Pour tous modèles de pinces à verre en zamak

Zingué					
INDOOR	QS	Q	d	L	
250680-820	QS-28	Q-6	M8	20	50

Pour tous modèles de pinces à verre en 304

304					
INDOOR	QS	Q	d	L	
230680-820	QS-26	Q-6	M8	20	50

Pour tous modèles de pinces à verre en 316

316					
OUTDOOR	QS	Q	d	L	
240680-820	QS-27	Q-6	M8	20	50

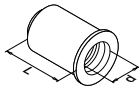

Rivet borgne
tête plate

MOD 0800

304						
INDOOR	QS	Q	d	L		
230800-616	QS-38	Q-29	M6	Ø 9,0	16	50
230800-817	QS-39	Q-29	M8	Ø 11,0	17	50
230800-121	QS-40	Q-29	M10	Ø 12,0	21	50

316						
OUTDOOR	QS	Q	d	L		
240800-616	QS-80	Q-29	M6	Ø 9,0	16	50
240800-817	QS-81	Q-29	M8	Ø 11,0	17	50
240800-121	QS-82	Q-29	M10	Ø 12,0	21	50

SELL OUT

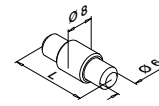

Goupilles de sécurité pour
pinces à verre et pinces à tôle

MOD 5015

Accessoires			
	Pour MOD	L	
205015-22	2800, 4200	22	4
205015-25	2500, 2600	25	4
205015-24	2400, 6000	30	4
205015-23	2300	34	4

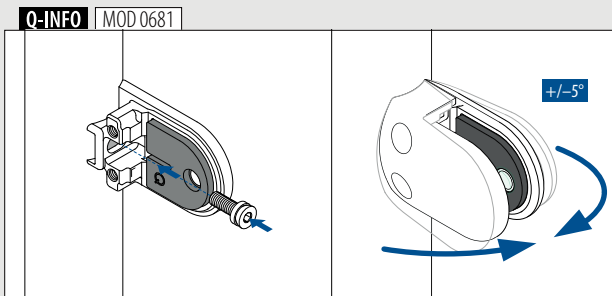
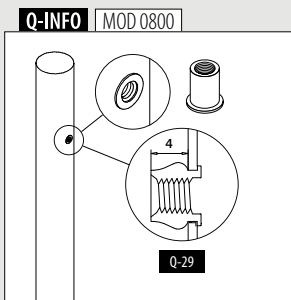

SELL OUT Seulement jusqu'à épuisement des stocks.

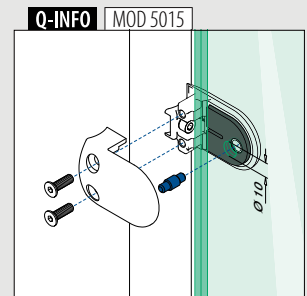
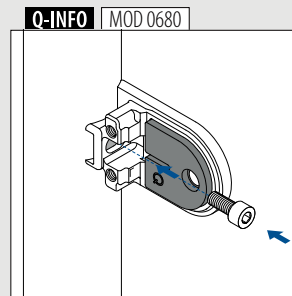

Pièces détachées pour pinces à verre

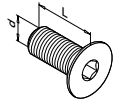

Vis 6-pans - tête fraisée

MOD 0670 - DIN 7991

Pour MOD 2100, 2500, 2700, 2800, 4200, 4400, 4600 en zamak

Zingué					
INDOOR	QS	Q	d	L	
250670-616	QS-43	Q-4	M6	16	50

Pour MOD 2400 en zamak

Zingué					
INDOOR	QS	Q	d	L	
250670-620	QS-44	Q-4	M6	20	50

Pour MOD 2100, 2500, 2700, 2800, 4200, 4400, 4600, 5100, 5200 en 304 et 316

316					
OUTDOOR	QS	Q	d	L	
240670-616	QS-41	Q-4	M6	16	50

Pour MOD 2300, 2400, 2600 en 304 et 316

316					
OUTDOOR	QS	Q	d	L	
240670-620	QS-42	Q-4	M6	20	50



Cache vis pour tous les modèles de pinces à verre (2 par pince)

MOD 5010

Accessoires

	Couleur	Pour MOD	
205010-00-00	Brut (gris)	2100, 2300, 2400, 2500, 2600, 2700, 4200, 4400, 4600, 5100, 5200	8
205010-00-17	Chromé brillant		8
205010-00-19	Aspect inox brossé		8
205010-00-31	Noir RAL 9005		8
205010-00-32	Blanc RAL 9016	2800	8
205010-00-33	Gris anthracite RAL 7016		8
205010-28-00	Brut (gris)	2800	8
205010-28-17	Chromé brillant		8
205010-28-19	Aspect inox brossé		8
205010-28-31	Noir RAL 9005		8

Cales pour adaptateurs à verre

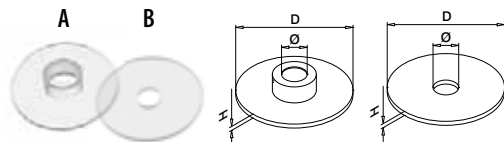
**MOD 5031 / 5032 / 5034 / 5035 / 5039 / 5038 / 5030**

Accessoires		Pour MOD	D	Ø	H	Pièces par adaptateur	
205032-47	A	0747 + 0750 + 0751 (Ø 50mm)	48	10	2	1	8
205031-47	B					1	8
205034-030	A	0746 + 0740 + 0754 (Ø 30 mm)	28	8	2	2	8
205034-025	A	0755 (Ø 25 mm)	24	6	1	1	8
205035	B					1	8
205034-050	A	0148 + 0117 + 9350 (Ø 50 mm)	48	8	2	2	8
205039	A	0752 + 0753	38	8	2	1	8
205038	B					1	8
NEW 205030-150-01-03	A	0749	45	19	3	1	8
NEW 205030-150-02-03	B					1	8

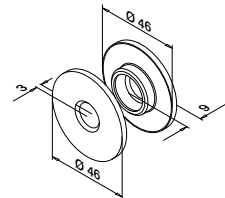
**MOD 5030**

Accessoires

	Pour MOD	
205030-150-99-80	0749	4

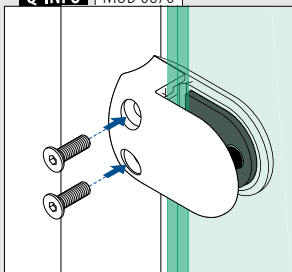
NEW**Q-INFO** MOD 0670

Perçage et taraudage



Boîte de 14 tarauds pour l'inox

MOD 1025

Accessoires			
	Q	M	
201025	Q-61	M3 - M12	1



Taraud pour MOD 0805

MOD 1029

Accessoires		
	Q	
201029	Q-119	1

NEW



Foret de perçage pour MOD 0805

MOD 1028

Accessoires		
	Q	
201028	Q-118	1

NEW



Gabarit de perçage

MOD 1020

Accessoires				
	Q	Pour tube Ø	M	
201020-042	Q-74	42,4	M5, M6, M8, M10	1
201020-048	Q-75	48,3	M5, M6, M8, M10	1

Ensemble complet



Ensemble de gabarits de perçage

MOD 1021

Accessoires				
	Q	Pour tube Ø	M	
201021-042	Q-76	42,4	M5, M6, M8, M10	1
201021-048	Q-77	48,3	M5, M6, M8, M10	1

SELL OUT

Huile de perçage et de coupe
Aérosol sans gaz propulseur

MOD 1027

Accessoires			
	Q	e	
201027	Q-64	300 ml	1

Q-INFO | MOD 1021

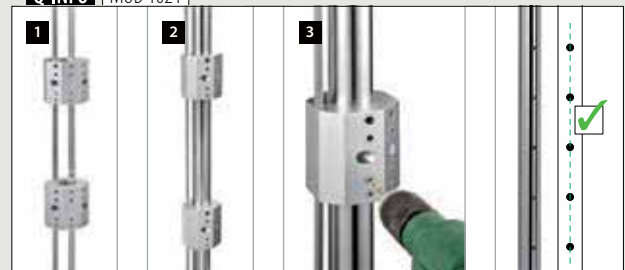

Perçage et taraudage

Gabarit de perçage pour Easy Alu

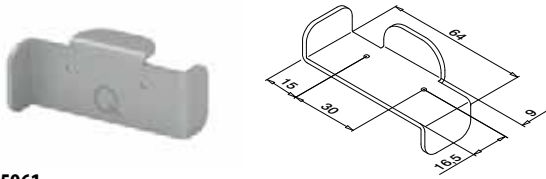

MOD 5961

Accessoires		
	Q	
205961	Q-85	1



Gabarit de perçage pour butée de verre

MOD 1041

Accessoires		
	Q	
201041	Q-117	1

NEW

Gabarit de perçage pour tubes à fond de gorge, set

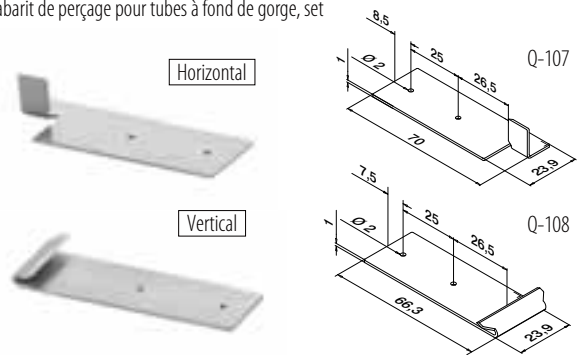

MOD 1022

Accessoires		
	Q	
201022	Q-107/Q-108	1

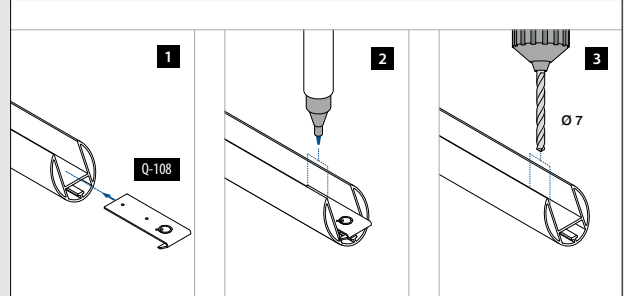
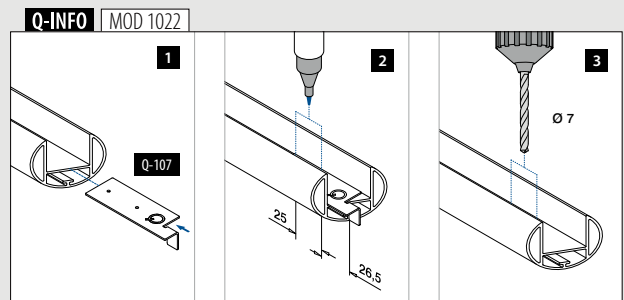
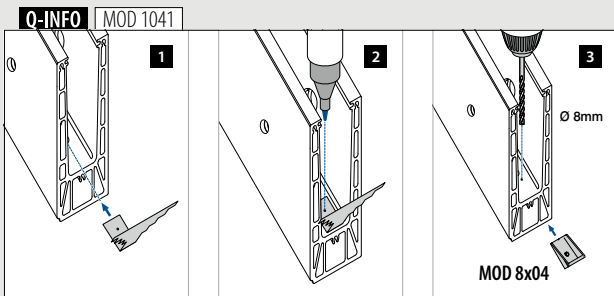
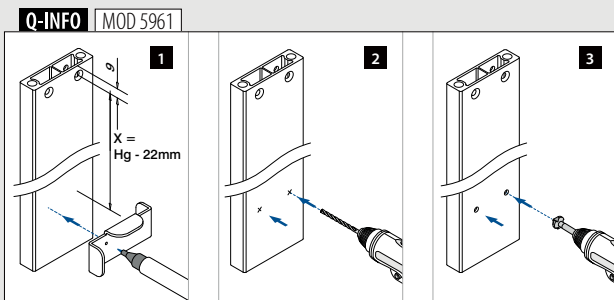

Q-82

Q-20

Gabarit de perçage



MOD 1023

Accessoires			
	Q	Pour Ø	
201023	Q-82	42,0 + 48,0	1

MOD 1024

Accessoires			
	Q	Pour Ø	
201024-042	Q-20	42,0	1



Colle à bois

PVAC colle pour assembler des pièces en bois

MOD 1335

Accessoires			
	Q	e	
201335	Q-73	250 ml	1

Goujons d'assemblage

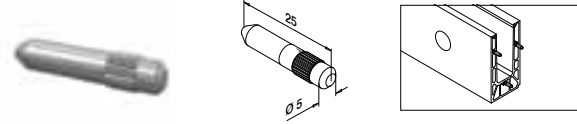

MOD 3005

316 Brut		
OUTDOOR		
143005		6



Foret avec butée pour bois

MOD 1026

Accessoires			
	Q	D	
201026	Q-80	15	1



Chevilles

MOD 0203

Bois		QS	
INDOOR			
200203	QS-512		50



MOD 0803 - DIN 7965

Zingué					
INDOOR	QS	d		L	
250803-120	QS-66	M10	Ø 17	20	50
304					
INDOOR	QS	d		L	
230803-818	QS-69	M8	Ø 14,5	18	50



Attache-câble

MOD 1050

Accessoires			
	Q	L	
201050	Q-50	300	100

ACCESSOIRES D'AIDE À L'INSTALLATION

Q-INFO | MOD 1024

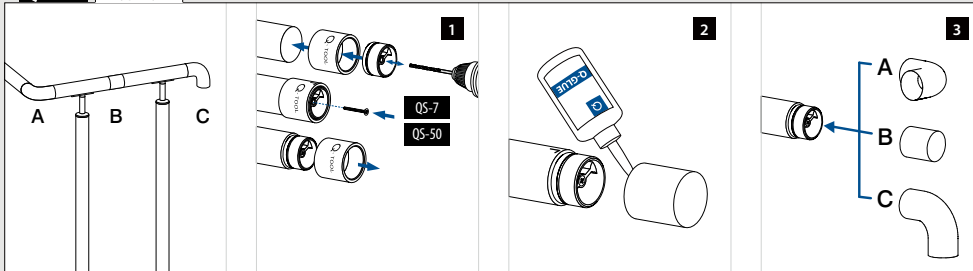

Q-INFO | MOD 1023 / 1024

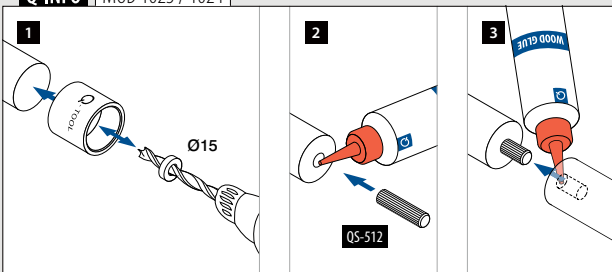

Q-INFO | MOD 0803

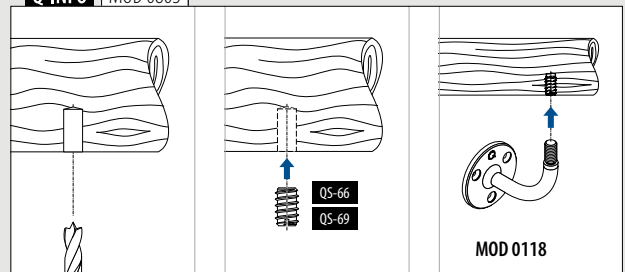

Accessoires d'aide à l'installation



Q-glue®
Colle spéciale inox.
Consommation par encollage env. 1 ml

MOD 1331

Accessoires			
	Q	e	
201331	Q-21	50 ml	1

Encollage par flacon (50 ml)

Ø 16 mm	Ø 42,4 mm	Ø 48,3 mm	Ø 60,3 mm
150	60	50	40



Ruban adhésif acrylique

MOD 1360

Accessoires				
	Q	W	L	
201360	Q-53	9	33 m (pour 11 m d'habillage)	1



Ruban adhésif acrylique transparent

MOD 1362

Accessoires				
	Q	W	L	
201362-012	Q-122	12	33 m	1

NEW



Q-spray, transparent
Q-spray pour installation de joint en caoutchouc

MOD 0620

Accessoires			
	Q	e	
200620	Q-65	1000 ml	1



Q-seal
Silicone pour verre, noir,
avec buses fournies

MOD 1340

Accessoires			
	Q	e	
201340	Q-24	310 ml = ca. 11,40 m	1



Ruban adhésif double-face

MOD 1361

Accessoires				
	Q	W	L	
201361-012	Q-111	12,7	33 m	1
201361-016	Q-98	16	33 m	1
201361-020	Q-99	20	33 m	1
201361-025	Q-112	25,4	33 m	1



Outil d'application pour ruban

MOD 1040

Accessoires	
201040	1

NEW

Q-INFO | MOD 1360 / 1361 / 1362

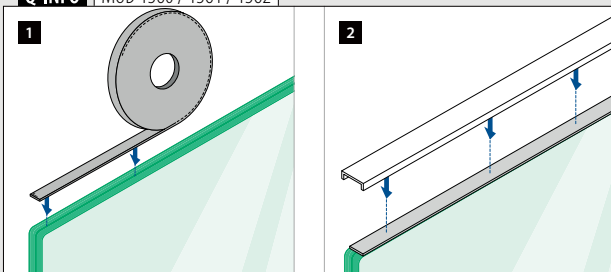

Q-INFO | MOD 0620

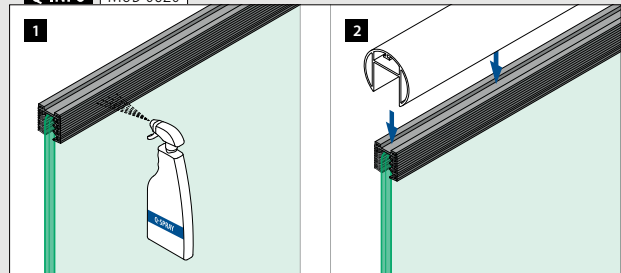

Q-INFO | MOD 1040

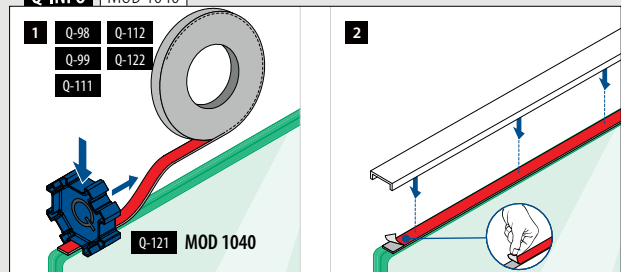

Accessoires d'aide à l'installation

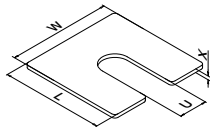

Cales, montage au sol

MOD 8216 - Easy Glass® Smart

	Aluminium		Brut		
	W	L	U	X	
168216-001	58	58	16	1	100
168216-002	58	58	16	2	100
168216-003	58	58	16	3	100

MOD 8416 - Easy Glass® Prime

	Aluminium		Brut		
	W	L	U	X	
168416-001	69	69	24	1	100
168416-002	69	69	24	2	100
168416-003	69	69	24	3	100

MOD 8516 - Easy Glass® Max

	Aluminium		Brut		
	W	L	U	X	
168516-001	78	78	24	1	100
168516-002	78	78	24	2	100
168516-003	78	78	24	3	100

MOD 8616 - Easy Glass® Strong

	Aluminium		Brut		
	W	L	U	X	
NEW 168616-001	93	93	24	1	100
NEW 168616-002	93	93	24	2	100
NEW 168616-003	93	93	24	3	100



Cales de montage pour système Easy Glass®

MOD 1006

	Accessoires		Épaisseurs	
	Q			
201006	Q-62		1, 2, 3, 4, 5 mm	520

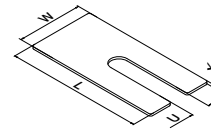

Cales, montage latéral

MOD 8236 - Easy Glass® Smart

	Aluminium		Brut		
	W	L	U	X	
168236-001	58	120	16	1	100
168236-002	58	120	16	2	100
168236-003	58	120	16	3	100

MOD 8336 - Easy Glass® Smart+

	Aluminium		Brut		
	W	L	U	X	
NEW 168336-001	58	122	16	1	100
NEW 168336-002	58	122	16	2	100
NEW 168336-003	58	122	16	3	100

MOD 8436 - Easy Glass® Prime

	Aluminium		Brut		
	W	L	U	X	
168436-001	58	135	16	1	100
168436-002	58	135	16	2	100
168436-003	58	135	16	3	100

MOD 8636 - Easy Glass® Strong

	Aluminium		Brut		
	W	L	U	X	
NEW 168636-001	58	144	16	1	100
NEW 168636-002	58	144	16	2	100
NEW 168636-003	58	144	16	3	100

MOD 6636 - Easy Glass® Up

	Aluminium		Brut		
	W	L	U	X	
166636-001	58	89	16	1	100
166636-002	58	89	16	2	100
166636-003	58	89	16	3	100

Bloc de réglage pour Easy Alu

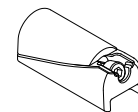

MOD 9027

	Aluminium		OUTDOOR	
	Q			
169027	Q-4			1



Q-INFO MOD 1006

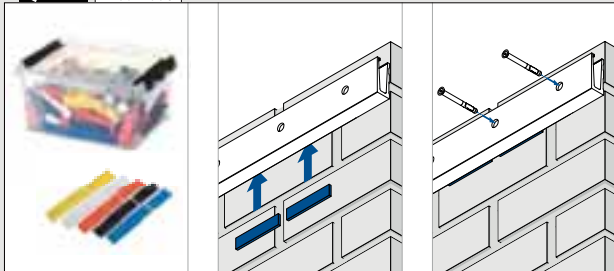

Q-INFO MOD 8x16

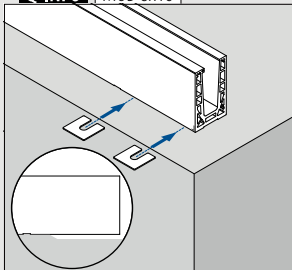

Q-INFO MOD 8x36 / 6636

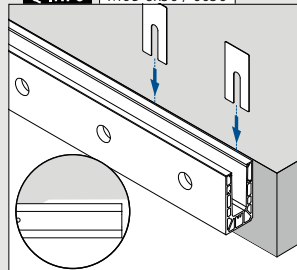

Q-INFO MOD 9027

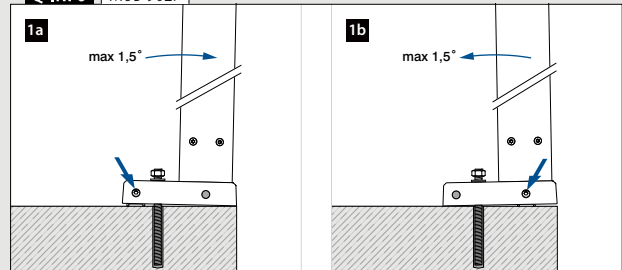

Nettoyage et entretien



Q-cleaner
Spray d'entretien inox.
Aérosol sans gaz propulseur

MOD 0601

Accessoires			
	Q	e	
200601	Q-23	300 ml	1



Q-ultra-clean
Nettoyant professionnel pour inox –
entretien et passivage (taches tenaces,
rouille, etc. . .)

MOD 0610

Accessoires			
	Q	e	
200610	Q-22	500 ml	1



Q-protector
Protégez les pièces en aluminium et en
acier inoxydable une fois l'installation
terminée.

MOD 0602

Accessoires			
	Q	e	
200602	Q-63	500 ml	1



Scotch®-Brite
Tampon pour nettoyage, finition et
dépolissage, très fin.
Pour éliminer les rayures

MOD 0640

Accessoires		
	Q	
200640	Q-25	10



Q-glass tex
Chiffons de nettoyage pour vitrage,
100 % viscose, 33 x 37 cm

MOD 0660

Accessoires		
	Q	
200660	Q-27	20



Pinneau de retouche pour les rayures

MOD 0802

Accessoires			
	Couleur	e	
200802-31	Noir, RAL 9005	12 ml	1
200802-33	Gris anthracite, RAL 7016	12 ml	1
200802-34	Telegris 4, RAL 7047	12 ml	1

Q-INFO | MOD 0640 / 0610



Q-25



MOD 0610
Q-21
Q-ultra-clean

Q-INFO



Informations de nettoyage
et entretien

9

Outillage



Set de tournevis hexagonale, 7 pièces

MOD 1010

Accessoires

SELL OUT	201010	Q-2	Q-2,5	Q-3	Q-4	Q-5	Q-6	Q-8	Q (☐)	☐
										1



Tournevis hexagonale

MOD 1008

Accessoires

SELL OUT	201008-10	Q (☐)	☐
		Q-10	1



Pince à river

MOD 1031

Accessoires

SELL OUT	201031	Q	Ø	☐
		Q-29	M6, M8, M10	1



Marteau

MOD 1030

Accessoires

201030	Q	☐
	Q-45	1



Niveau multi-usages pour tube rond ou carré pour tube rond et plat

MOD 1034

Accessoires

201034	Q	☐
	Q-46	1



Clé à ergot

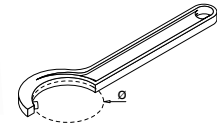

MOD 1013

Accessoires

	Q	Ø	☐
201013-025	Q-30	25 - 28	1
201013-030	Q-31	30 - 32	1
201013-050	Q-32	45 - 50	1
201013-060	Q-33	58 - 62	1
201013-070	Q-51	68 - 75	1



Clé pour vis à trous

MOD 1032

Accessoires

201032	Q	☐
	Q-78	1



Pince à circlips, trou Ø 2 mm, griffe 4 mm de longueur, ouverture 28 mm

MOD 1033

Accessoires

201033	Q	☐
	Q-110	1



Niveau de support mural pour Ø 40, Ø 42,4, Ø 48,3 mm

MOD 1035

Accessoires

201035	Q	☐
	Q-72	1

SELL OUT Seulement jusqu'à épuisement des stocks.

Q-INFO MOD 1034



Q-INFO MOD 1035



Q-INFO MOD 1035



Outillage



Outil pour Q-disc® et cale

MOD 1000

Accessoires		
	Q	
201000	Q-84	1



Outil multi-fonctions Easy Glass®

MOD 1001

Accessoires		
	Q	
201001	Q-71	1



Q-glass ventouse, 2 têtes, force portante/ direction de traction : 60 kg / horizontale

MOD 1060

Accessoires		
	Q	
201060	Q-28	1



Cale de positionnement

MOD 1062

Accessoires		
	Q	
201062	Q-56	2



Porte-paroi vitrée

Pour ép. verre de 0 à 80 mm.
Charge maximale de 100 kg par pièce.

MOD 1061

Accessoires		
	Q	
201061	Q-55	2

SELL OUT

OUTILLAGE ACCESSOIRES

Q-INFO MOD 1000

Q-INFO MOD 1061

Q-INFO MOD 1001

Q-INFO MOD 1062

Outillage



Outil de démontage Fast Fix

MOD 7802

316	Inox brossé		
OUTDOOR	Pour câble Ø		
207802-003	3,2		1
207802-004	4,0		1



Pince coupante

MOD 7800

Accessoires	Q	Pour câble Ø	
207800	Q-39	1,5 - 4,0	1

Pour une efficacité optimale, l'inox doit être découpé avec une scie adaptée. Les scies à inox sont dotées d'un moteur tournant au ralenti mais très résistant. Le poids réduit de la scie en fait l'outil professionnel indispensable sur un chantier.

201070-23
Q-34

Scie spéciale inox

Moteur 0,8 kW - 230 V, 60 tr/m, refroidissement, 17 kg. Dimensions : 490x425x600 mm (l x L x H).
Lame non fournie. Pour coupes droites.

201071
Q-35Socle de rangement
scie inox201072
Q-36

Lame pour scie inox

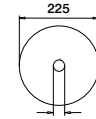
HSS, 225 x 2,2 x 32,
168 Z201074
Q-38Support de matériau
ajustable à la verticale
pour tube Ø 26-168 mm201073
Q-44Ébavureur intérieur/
extérieur pour tubes
Ø 10-54 mm

MOD 1070 / 1071 / 1072 / 1073 / 1074

Accessoires

	Q	
201070-23	Q-34	1
<small>SELL OUT</small> 201071	Q-35	1
201072	Q-36	1
201073	Q-44	1
<small>SELL OUT</small> 201074	Q-38	1



VOUS CHERCHEZ DES ARTICLES
POUR FAIRE LA PROMOTION DE
Q-RAILING ?

Demandez-nous les articles
et sets promotionnels ainsi
que les autres produits.















































Q-railing

INDEX DES SYMBOLES

304	304 Inox	Verre de sécurité Mono	Mono	Verre
316	316 Inox	Verre de sécurité Feuilleté	Feuilleté	
Aluminium	Aluminium	Hêtre	Chêne	Bois
Plastique	Plastique	Kambala	Bois	
Acier	Acier	Inox brossé	Poli miroir	Finition
Zamak	Zamak	INDOOR		Pour l'intérieur
Zingué	Zingué	OUTDOOR		Pour l'extérieur
Laiton	Laiton			

 /  /  / \emptyset	Forme/taille du tube / tube à fond de gorge		Taille de la tête de perçage
	Information complémentaire	 QS-36  467 /  QS-36	Q-ancre conseillée voir page 467
T	Épaisseur de verre	 QS-53  472 /  QS-53	Q-vis conseillée voir page 472
	Conditionnement	Q-22	Outil à utiliser

NEW	Nouveau produit		Marquage CE
SELL OUT	Articles en vente (uniquement disponibles dans la limite des stocks disponibles)	EXTRA STRONG	Extra fort
PREFIX	Options de préfixes disponibles.		

 	Livraison par camion		Certification AVIS Technique
	Serrage avec tournevis hexagonale		Testé chez CSTB
	Clé dynamométrique	 	SIA 358:2010 / SIA 261:2014
	Serrage avec clef plate	 	Conforme aux normes EN 1991 / EN 1990
	Serrage avec clef à ergot		Conforme aux normes NEN 2608 (Eurocodes 1990-1999:2011)
	Vissage avec tournevis		Certification LGA Typen geprüft
	Vissage avec tournevis (Torx)		Calcul statique selon DIN 18008
	Pièce à frapper (Easy Hit®)		Certification CTE
	Pièce à coller		Testé chez Applus
	Utilisez un couteau pour couper		Conforme aux normes NTC UNI 11678-2017
	Utilisez une scie pour couper		Conforme aux normes DIN 18008
	Pièce à souder		Testé chez WTCB.be & CSTC.be
	AW-propulsion		Conforme aux normes NBN B03-004
	Montage à 90° impossible		Conforme aux normes Miami Dade County
	Écartement 85 mm		Testé chez International ICC Evaluation Service
	Certification AbP (Allgemeines bauaufsichtliches Prüfzeugnis)		IK code solidité
	Certification ETB		Indice de rendu des couleurs
	Certification AbZ (Allgemeine bauaufsichtliche Zulassung)		Dali Lighting Control
	Conforme aux normes DIN EN 12600		Rayon de cintrage minimum
	Conforme aux normes British Standard 6180		Installation faite par un électricien agréé
	Testé chez Verrotec		

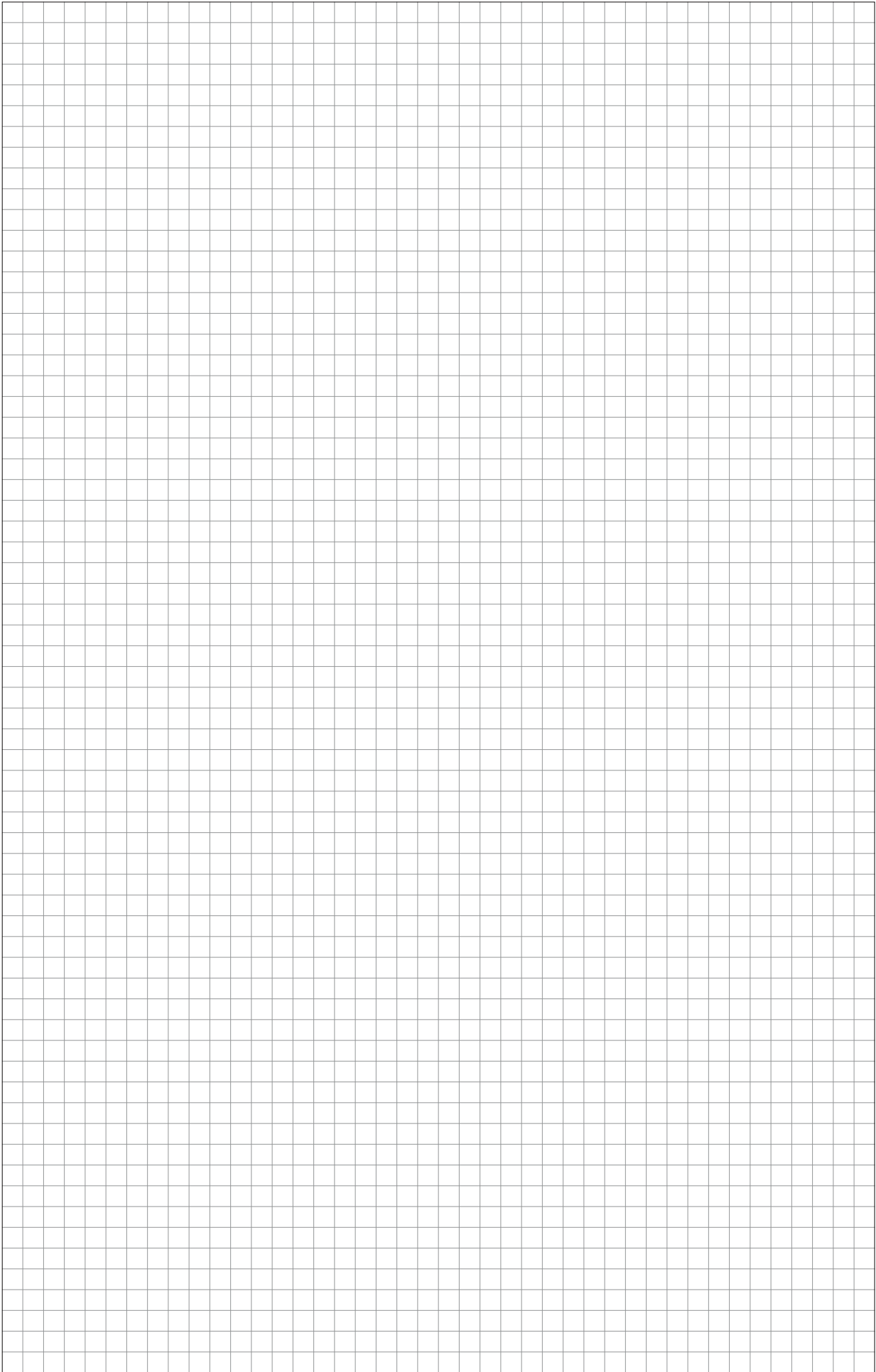

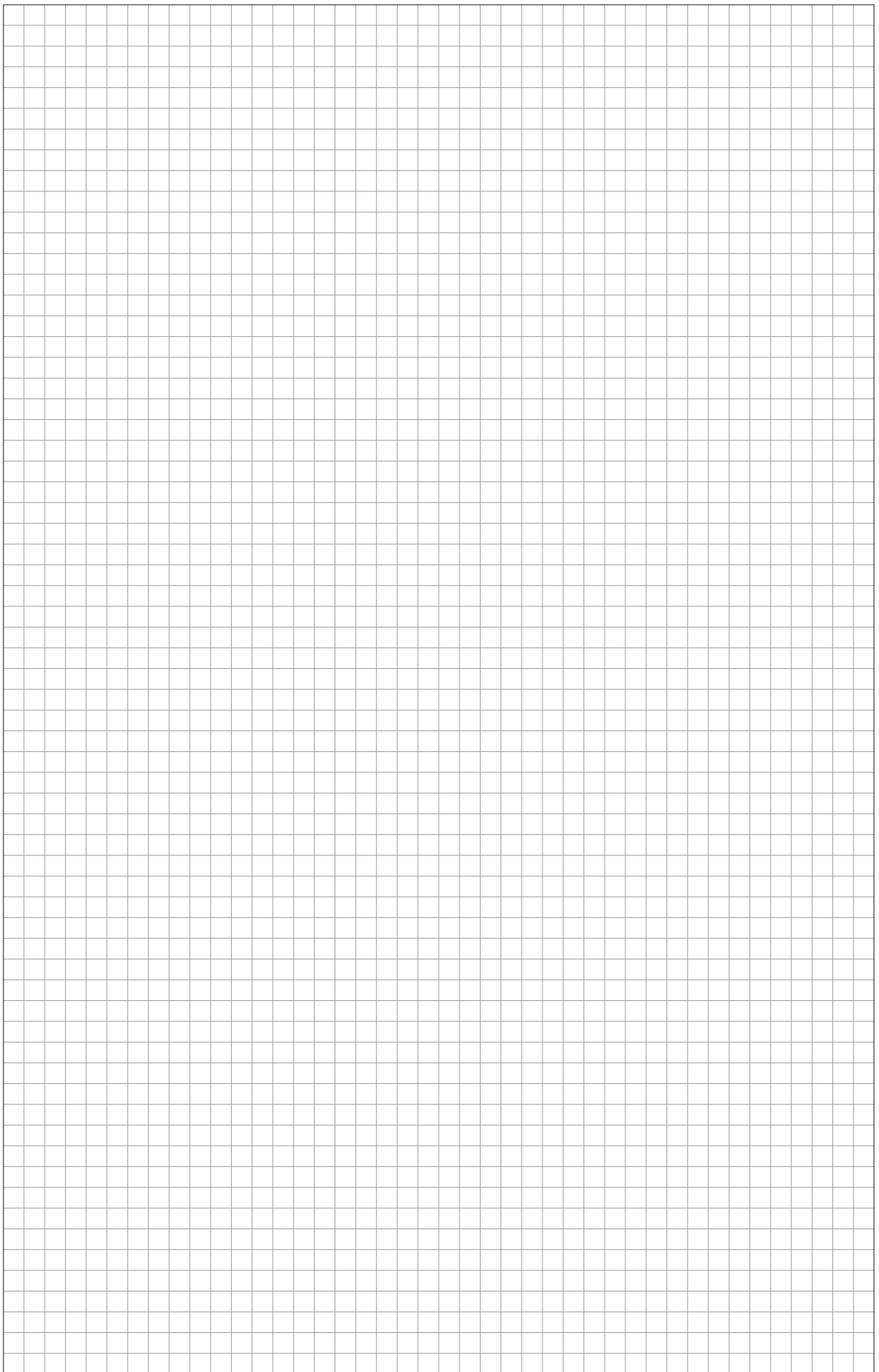



© 2023 Q-railing
Emmerich am Rhein, Allemagne

Droit d'auteur / Droit de reproduction

La conception, la mise en page du présent catalogue, les textes, les passages, les tableaux, les images, les marques, les marques de fabrique, les logos, les graphiques et autres contenus du présent catalogue sont soit la propriété de la société Q-railing Europe GmbH & Co. KG, Allemagne, soit ils sont utilisés avec l'autorisation du titulaire. Ils sont soumis au droit d'auteur dans le monde entier. Sauf indication contraire, toutes les marques et marques de fabrique utilisées dans le présent catalogue ainsi que les droits sur les signes distinctifs, les dessins et modèles et les modèles d'utilité sont la propriété de la société Q-railing Europe GmbH & Co. KG, Allemagne ou de nos partenaires commerciaux. Toute violation du droit d'auteur, du droit des marques et de tout autre titre de protection peut faire l'objet de poursuites civiles et pénales en Allemagne mais aussi dans de nombreux autres pays. Si vous devez utiliser, copier, reproduire ou modifier au sens large du terme, traduire ou mettre à disposition ou souhaiter mettre à disposition à des tiers des contenus individuels ou des pages entières, il vous faut notre autorisation préalable écrite. Veuillez donc nous en faire la demande au préalable. Dans le cas contraire, nous nous réservons le droit d'engager une action en justice à votre rencontre.



IMPORTANT

Nous nous réservons le droit de modifier les produits et les dimensions sans préavis. Les photos ne sont pas contractuelles. Aucune réclamation dans ce sens ne sera acceptée. Nous déclinons toute responsabilité quant aux erreurs d'impression du catalogue. Q-railing s'engage à remplacer les pièces défectueuses, après constatation d'un défaut d'usine. Aucune reprise ne sera accordée, en cas de modification du matériel par le client. Tout retour de marchandise non-autorisé sera refusé. Q-railing ne pourra être tenu pour responsable des spécificités de montage de chaque pays. (Vérifier les normes en vigueur!)

Ceci est valable pour nos conditions générales de vente.





THE PREMIUM BRAND IN RAILING SYSTEMS



Q-railing Belgium (Meert sprl)
Vijfhuizen 10
9420 Erpe-Mere
Belgique

T. +32 (0) 53 605 980
F. +32 (0) 53 806 730
sales@q-railing.be



Q-RAILING CATALOGUE 2023, B-FR • LANGUAGE FR • NO CURRENCY